

FINAL CHECK LIST

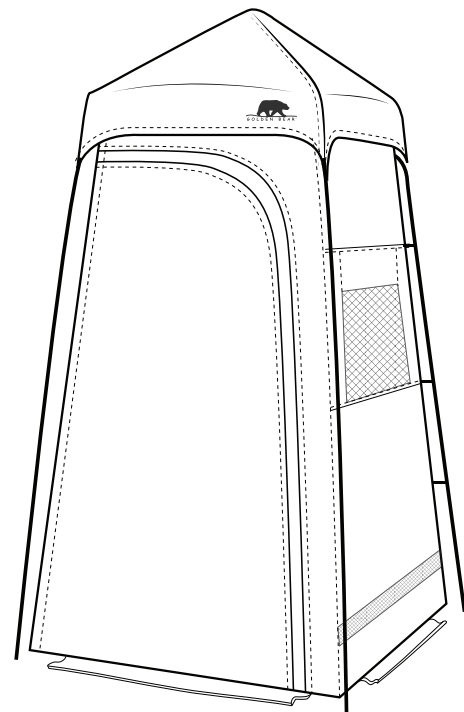

- Double check the tent poles are secure in the pins.
- All stakes are secured into the ground.
- Rainfly is securely attached to tent.

Enjoy your new
GOLDEN BEAR privacy tent.



Manufactured by World Famous Sports

For any questions or concerns please call our toll free customer service line.

WORLDFAMOUSSPORTS.COM

(833) 937-1234
(833) WFS-1234

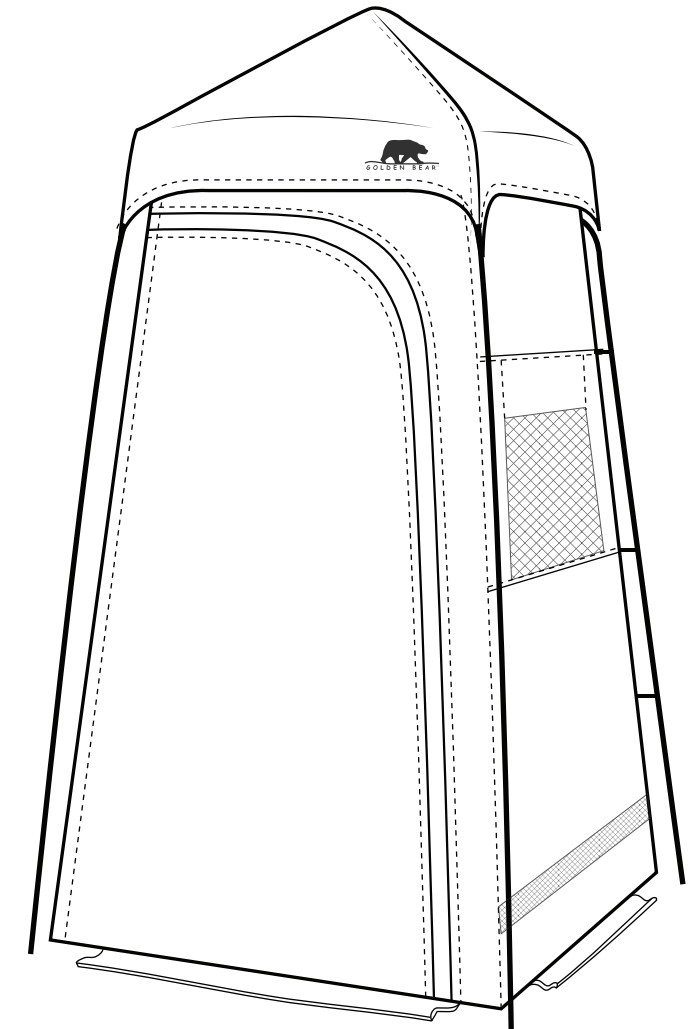

INSTRUCTION MANUAL

MODEL #:T-PRIVACY

IMPORTANT

Treat your tent seams with waterproofing. Set up your tent at home before your first camping trip. A dark campsite is no place to learn how to assemble your WORLD FAMOUS SPORTS tent. Read assembly instructions with care. When selecting a campsite, make sure you find a flat area with good drainage free from all sharp objects. Protect your investment.



This product can expose you to chemicals including Diethylhexyl Phthalate, which is known to the state of California to cause cancer, birth defects, or other reproductive harm. For more info go to: www.P65Warnings.ca.gov

PARTS

PARTS IDENTIFICATION:

- A. Tent(1)
- B. Rainfly(1)
- C. Shock Corded Fiber Glass Poles..(6)
[2 Long & 4 Short Fiber Glass Poles]
- D. Tent Stakes (8) (& guyline)
- E. Carry bag (1)

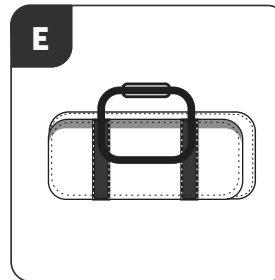
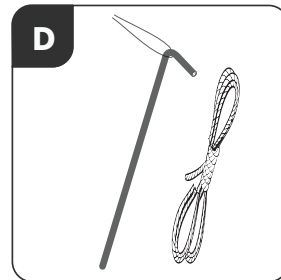
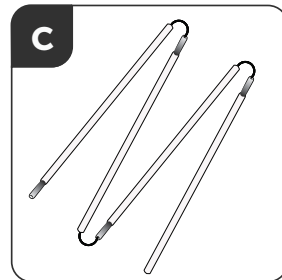
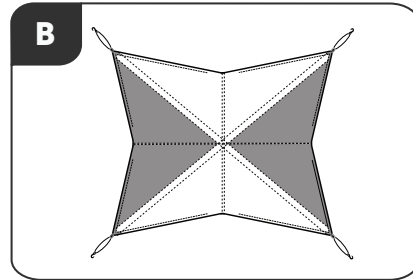
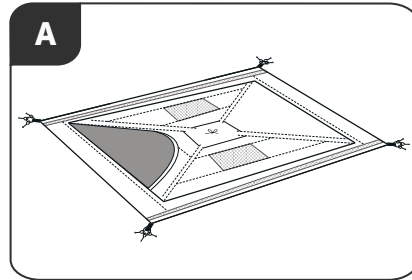

ASSEMBLY

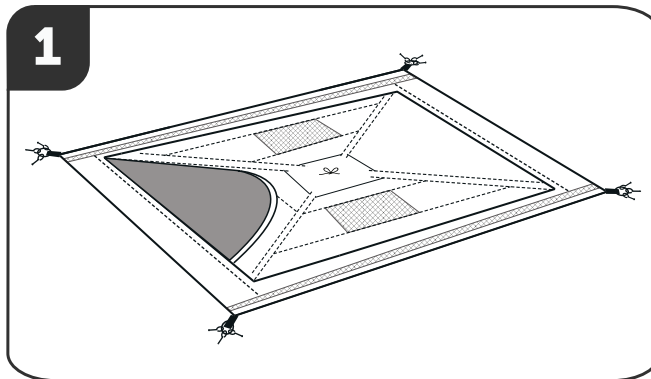

STEP 1: Unfold and spread the privacy tent out on clear camp area. Remove all stones and sharp objects.

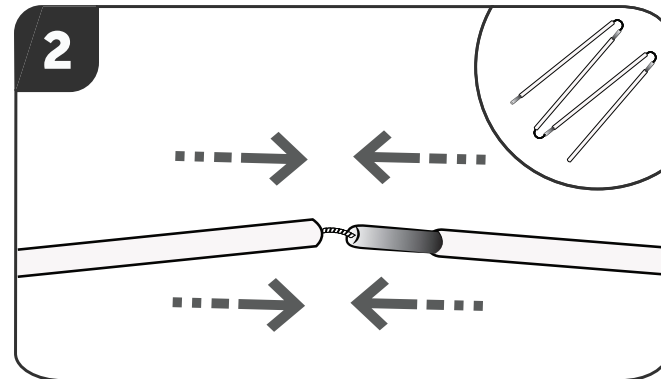

STEP 2: Assemble all shock corded poles by unfolding and slipping shafts together.

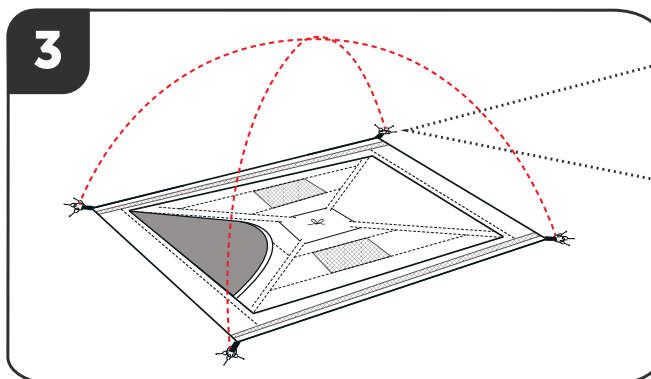

STEP 3: Lay the two long pole assemblies across the tent to form an "X". Then insert the MIDDLE pin and ring attached on the corner of the tent, into the open metal ferrule at the end of the pole assembly. **Repeat for all four corners.** In repeating the procedure, you have now formed two arches.

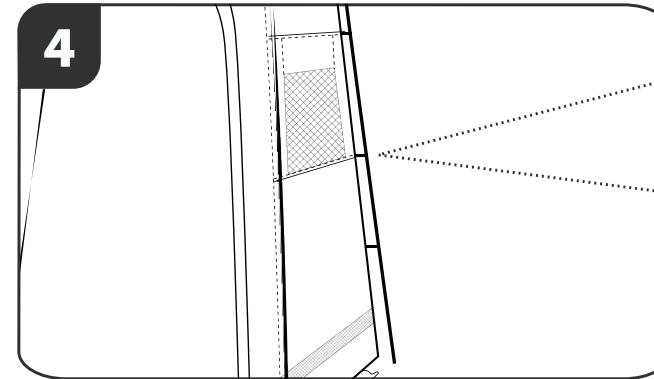

STEP 4: Erect the privacy tent by attaching the clips located on the tent, onto the fiber glass poles securely until it snaps into place.

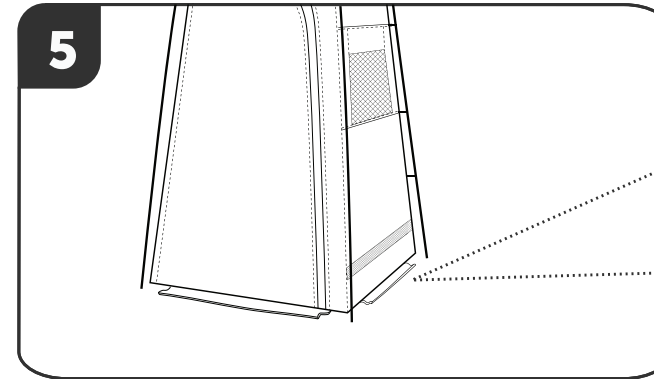
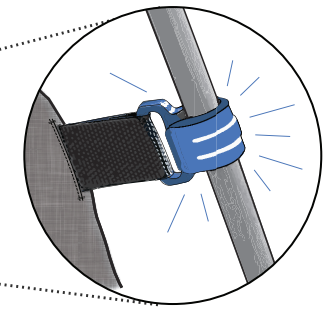

STEP 5: Reinforce the base of the privacy tent by sliding the remaining short fiber glass poles through the sleeves located at the bottom of the tent.

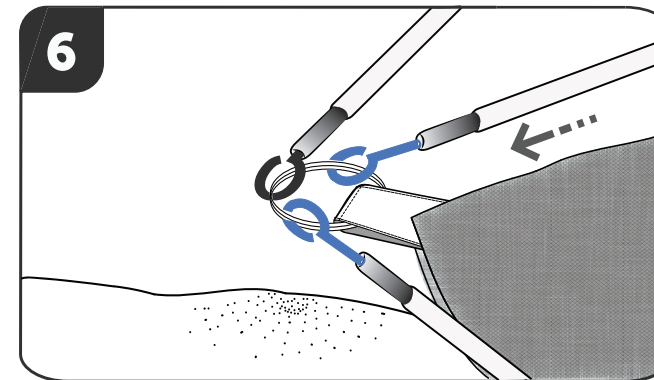
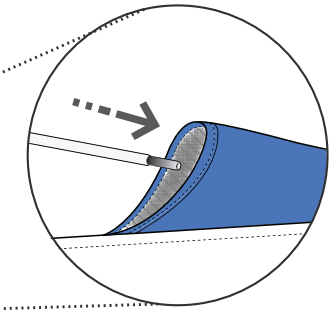

STEP 6: Insert the short fiber glass poles into the remaining pins and ring attached on the corner of the tent into the open metal ferrule at the end of the pole assembly, **Repeat for all four corners.**

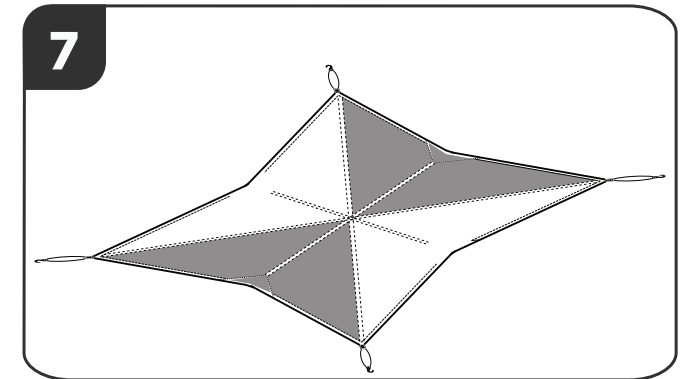

STEP 7: Spread out the rainfly over the top of the tent to prevent debris from entering the tent.

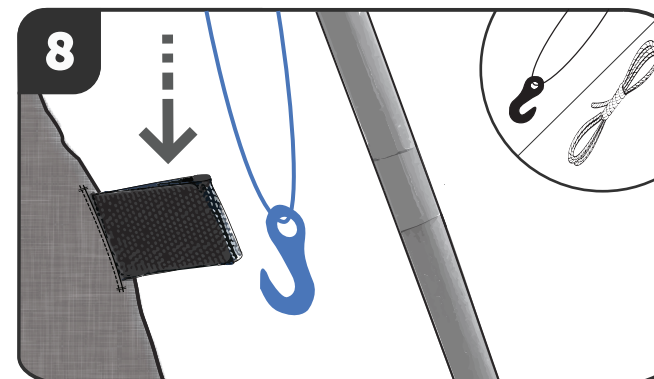

STEP 8: Each corner of the rainfly has a bungee cord with plastic "S" hooks. - Attach each "S" hook to the fabric loop. Then attach one end of the guyline to the fabric loop as well.

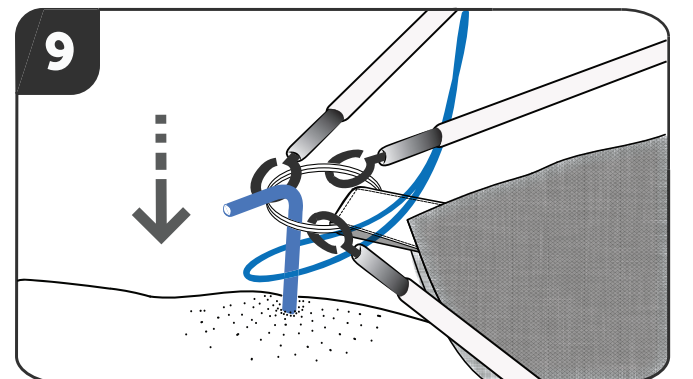

STEP 9: Securely insert the Tent Stakes into the ground through the small pin and ring on each corner of the tent. Then tie the other ends of the guylines to all tent stakes for stability.