

CLAVORGOMMA[®]
LAVORGOMMAGROUP





MADE IN ITALY



HOT VULCANIZATION



CUSTOMIZATION



SIZING



FAST DELIVERY



○○○ — CUSTOMIZED BELTS



CUSTOMIZED BELTS

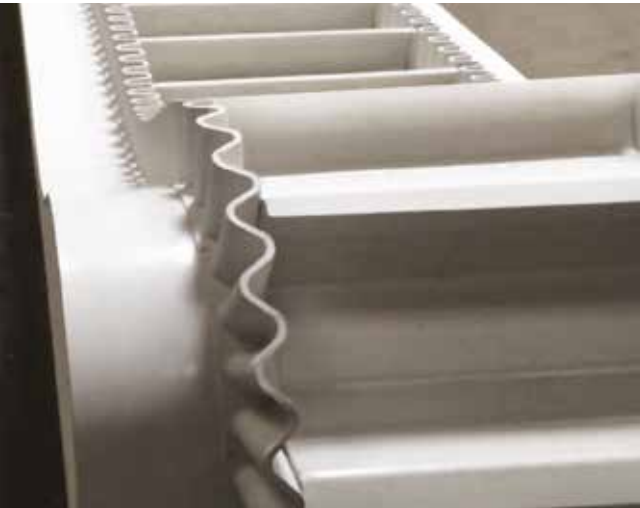

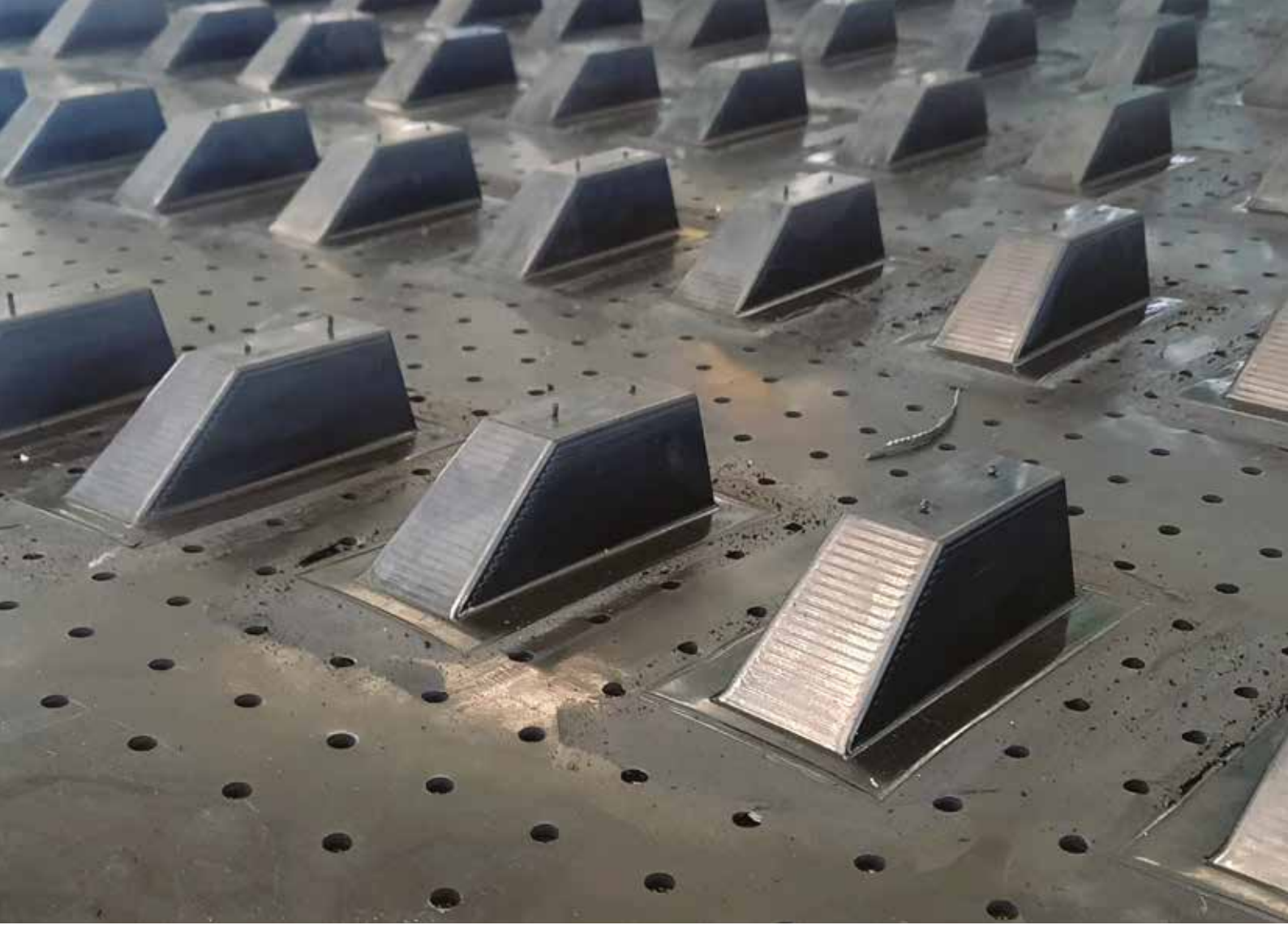

CUSTOMIZED BELTS

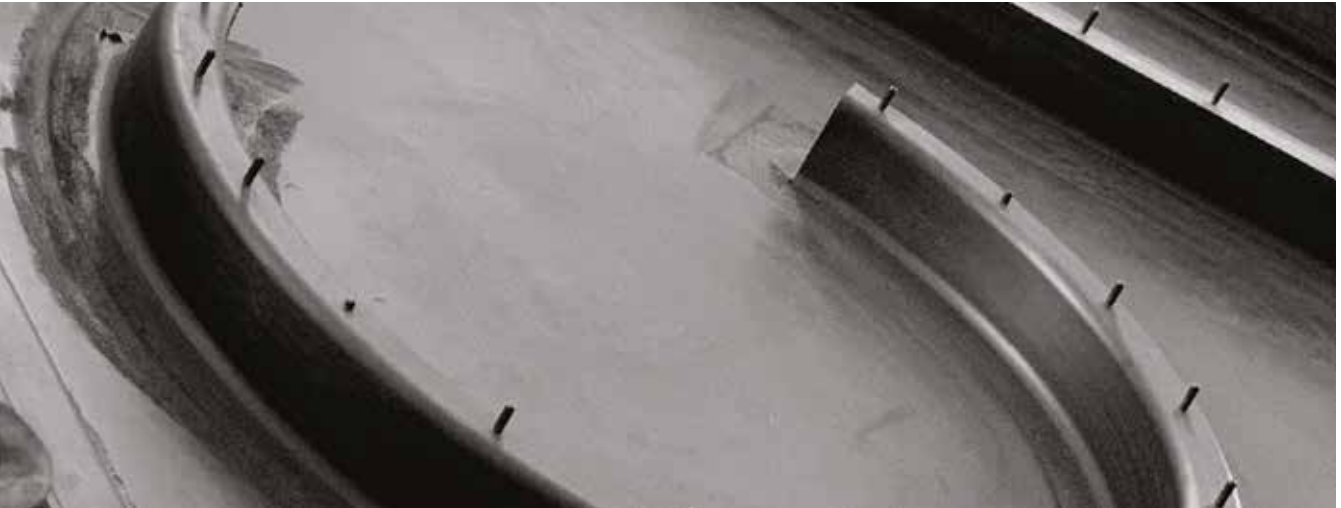

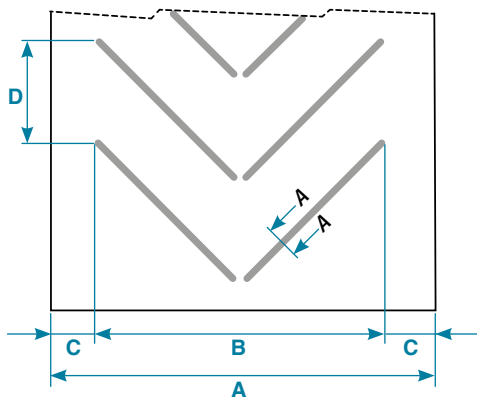

CHEV32

	A	B	C	D	E	F
	mm					
a richiesta	1000	(A-B)/2	500	32	20	
a richiesta	1400	(A-B)/2	500	32	20	
a richiesta	1570	(A-B)/2	500	32	20	

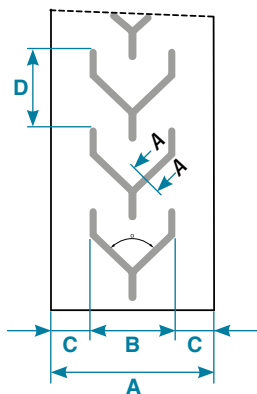
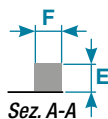

CHEV-YB10-15-25-30 .1

	A	B	C	D	E	F
	mm					
a richiesta	350	(A-B)/2	330	10-15-25-30	20	

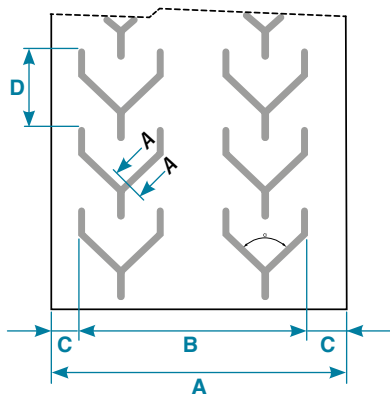
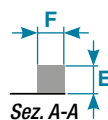

CHEV-YB10-15-25-30 .2

	A	B	C	D	E	F
	mm					
a richiesta	950	(A-B)/2	330	10-15-25-30	20	

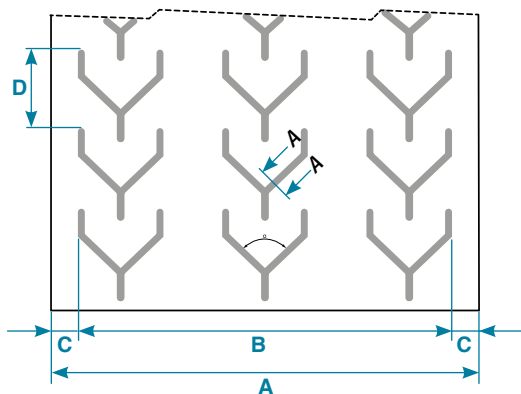
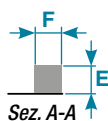

CHEV-YB10-15-25-30 .3

	A	B	C	D	E	F
	mm					
a richiesta	1550	(A-B)/2	330	10-15-25-30	20	

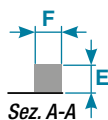

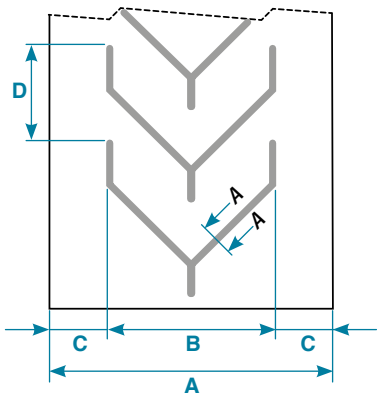

CHEV-Y10-15-25-30

A	B	C	D	E	F
mm					
a richiesta	600	(A-B)/2	330	10-15-25-30	20

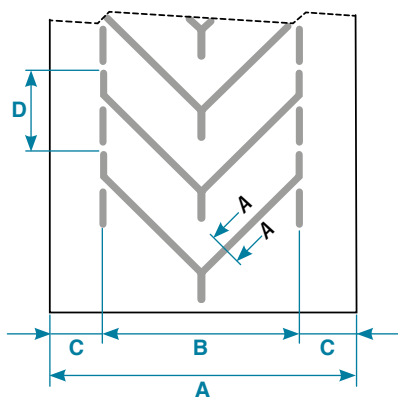

CHEV-YA10-15-25

A	B	C	D	E	F
mm					
a richiesta	750	(A-B)/2	300	10-15-25	20

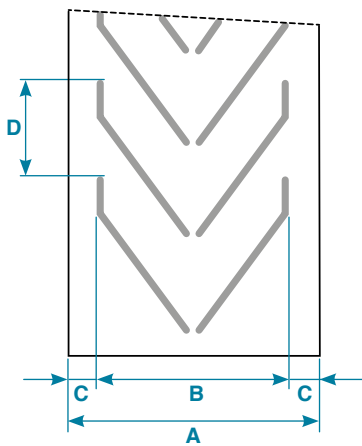
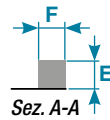

CHEV15B .1

A	B	C	D	E	F
mm					
a richiesta	600	(A-B)/2	300	15	15

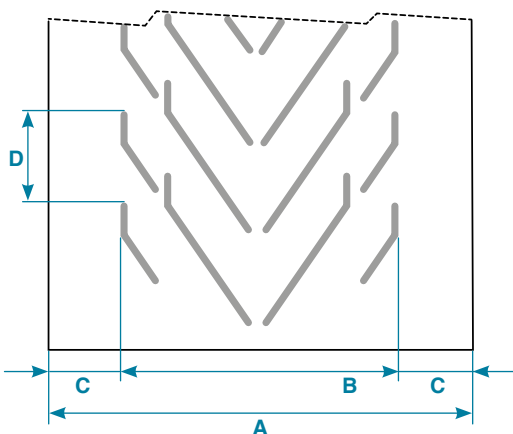
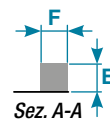

CHEV15B .2

A	B	C	D	E	F
mm					
a richiesta	900	(A-B)/2	300	15	15



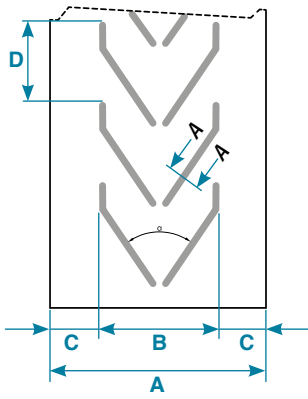

CHEV10-15-25 .1

A	B	C	D	E	F
mm					
a richiesta	450	(A-B)/2	300	10-15-25	15

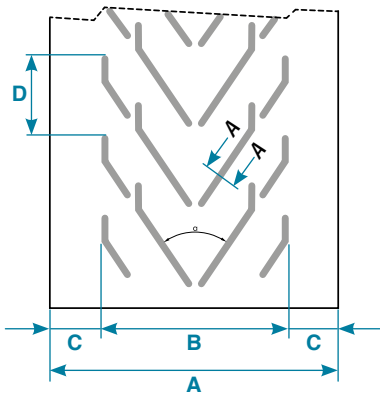
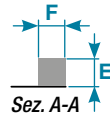

CHEV10-15-25 .2

A	B	C	D	E	F
mm					
a richiesta	700	(A-B)/2	300	10-15-25	15

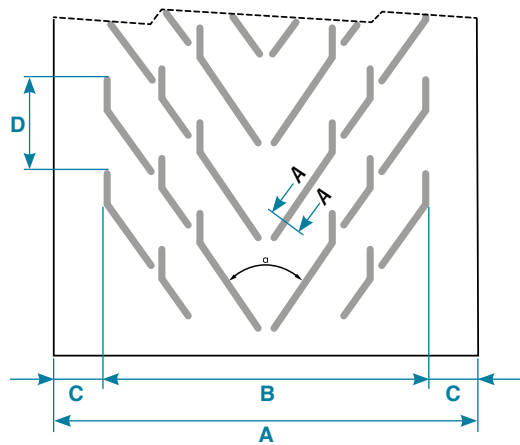
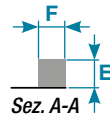

CHEV10-15-25 .3

A	B	C	D	E	F
mm					
a richiesta	1050	(A-B)/2	300	10-15-25	15

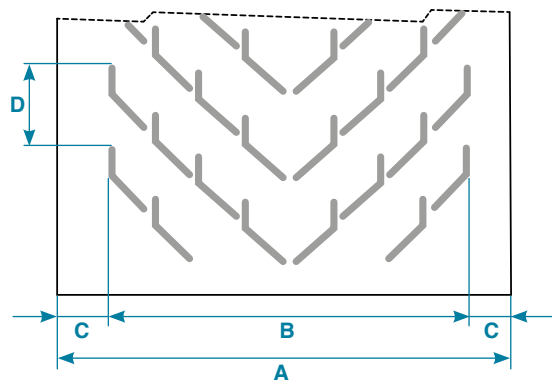

CHEV15C .4

A	B	C	D	E	F
mm					
a richiesta	1580	(A-B)/2	3801	15	15



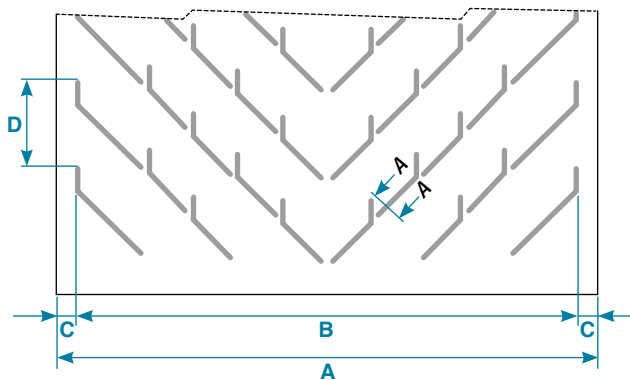

CHEV15C .5

A	B	C	D	E	F
mm					
a richiesta	2200	(A-B)/2	380	15	15

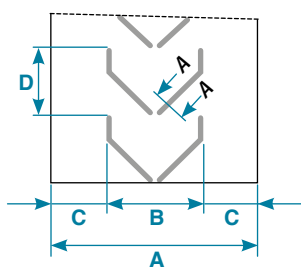

CHEV25 .1

A	B	C	D	E	F
mm					
a richiesta	500	(A-B)/2	350	25	20

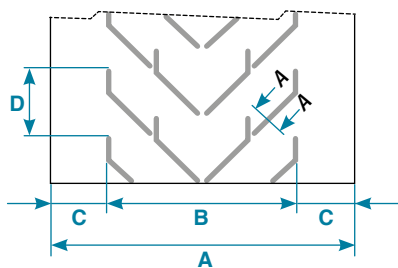

CHEV25 .2

A	B	C	D	E	F
mm					
a richiesta	1000	(A-B)/2	350	25	20

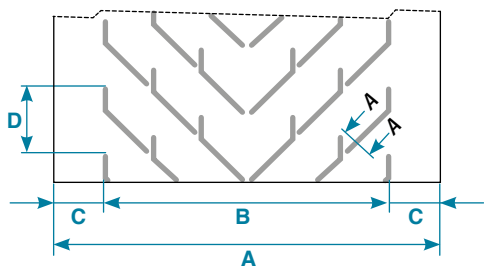
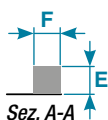

CHEV25 .3

A	B	C	D	E	F
mm					
a richiesta	1500	(A-B)/2	350	25	20

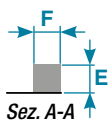

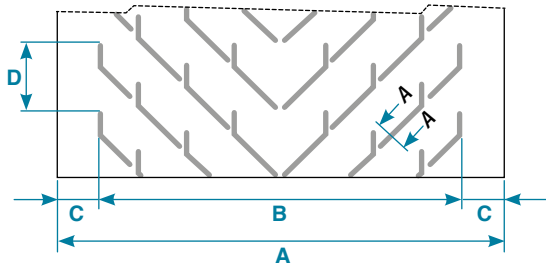

CHEV25 .4

A	B	C	D	E	F
mm					
a richiesta	1900	$(A-B)/2$	350	25	20

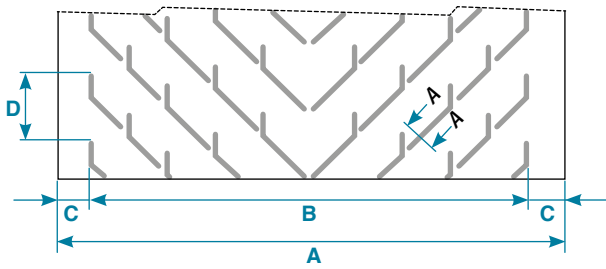
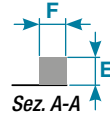

CHEV25 .5

A	B	C	D	E	F
mm					
a richiesta	2300	$(A-B)/2$	350	25	20

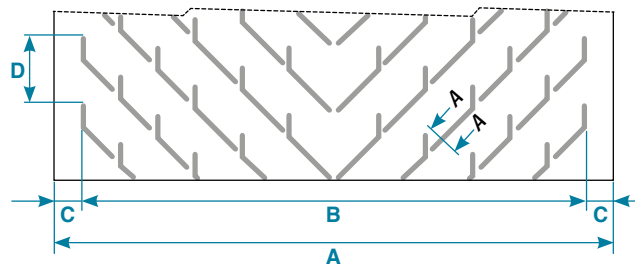
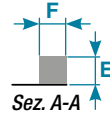

CHEV25 .6

A	B	C	D	E	F
mm					
a richiesta	2700	$(A-B)/2$	350	25	20

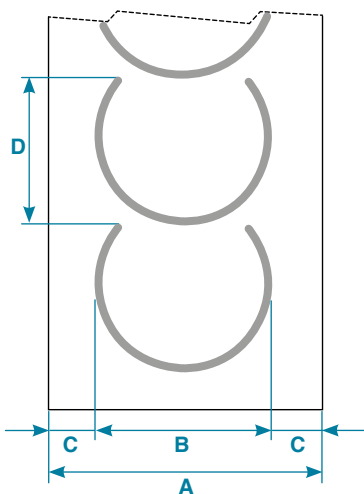
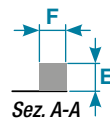

CHEVC

A	B	C	D	E	F
mm					
a richiesta	350	$(A-B)/2$	a richiesta	32	25

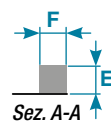

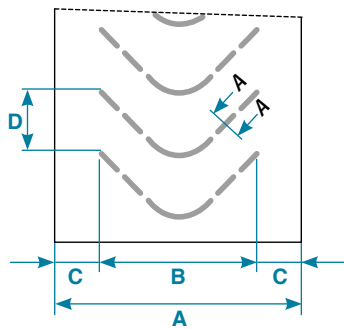

LIST-BREAK .1

	A	B	C	D	E	F
	mm					
a richiesta	510	$(A-B)/2$	200	15	15	

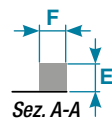

LIST-BREAK .2

	A	B	C	D	E	F
	mm					
a richiesta	1040	$(A-B)/2$	200	15	15	

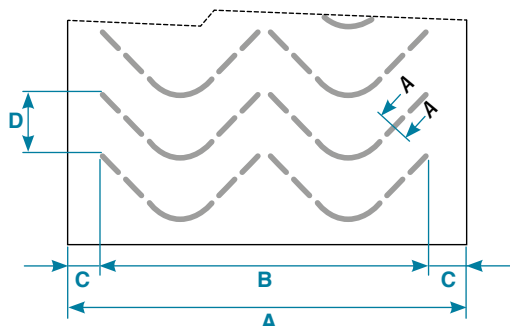
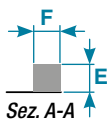

LIST-BREAK .3

	A	B	C	D	E	F
	mm					
a richiesta	1570	$(A-B)/2$	200	15	15	

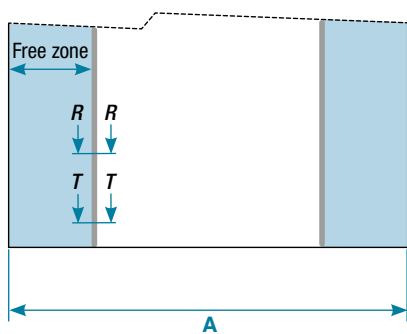
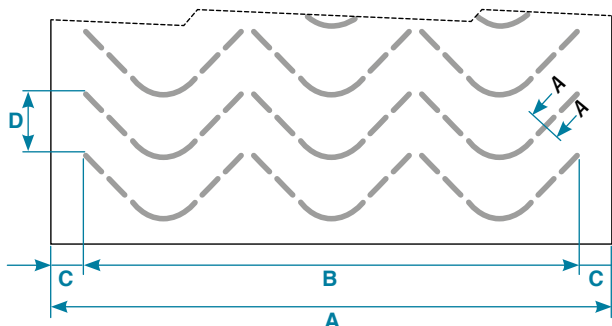
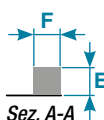

LONG. PROFILES

	A	Free zone	E	F	Sez.
	mm				
a richiesta	on demande		20	15	R-R
a richiesta	on demande		15	20	R-R
a richiesta	on demande		20	20	R-R
a richiesta	on demande		25	20	R-R
a richiesta	on demande		25	50	R-R
a richiesta	on demande		8	13	T-T
a richiesta	on demande		11	17	T-T
a richiesta	on demande		15	21	T-T
a richiesta	on demande		15	30	T-T

Sez. R-R

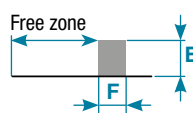

Sez. T-T

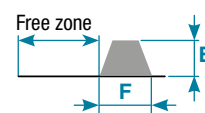



SIDEWALLS



SIDEWALLS

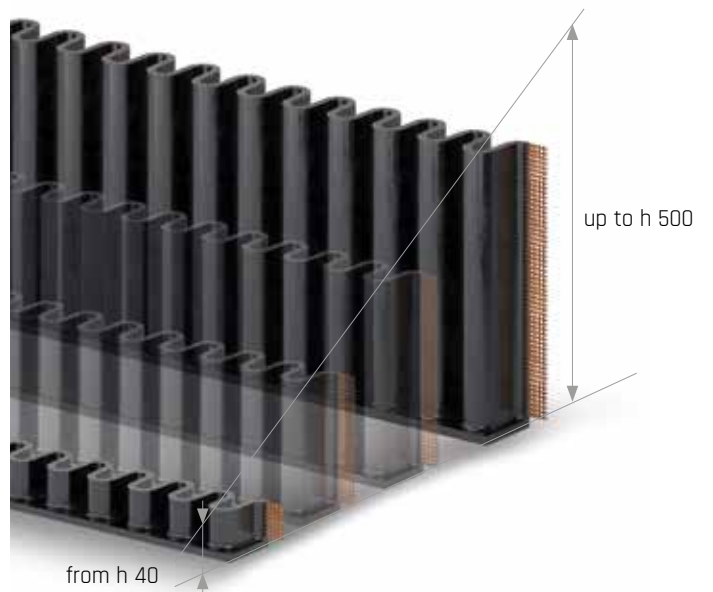
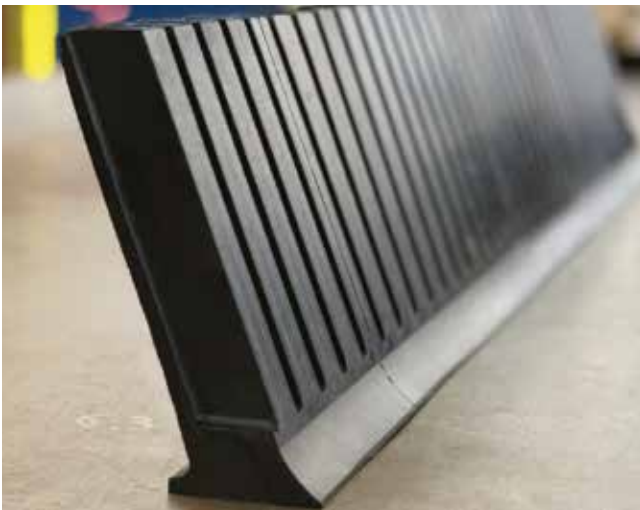



CLEATS



CLEATS



TC

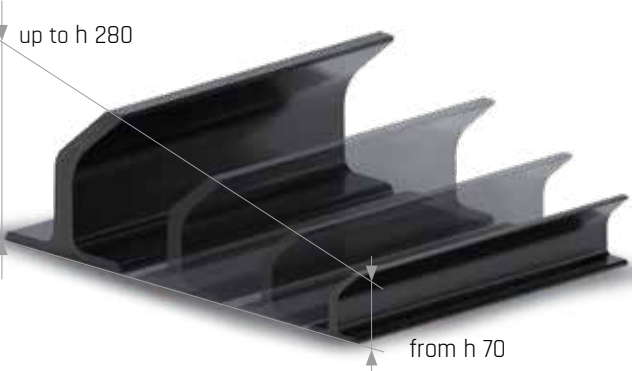

T

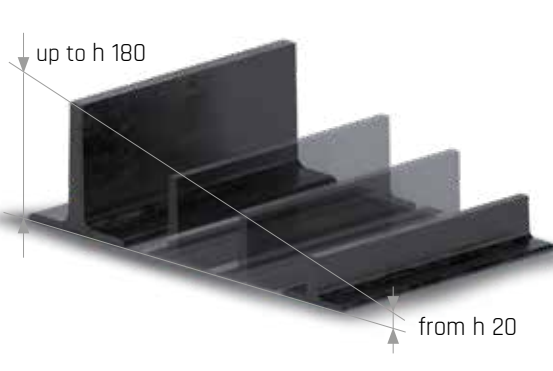

TB

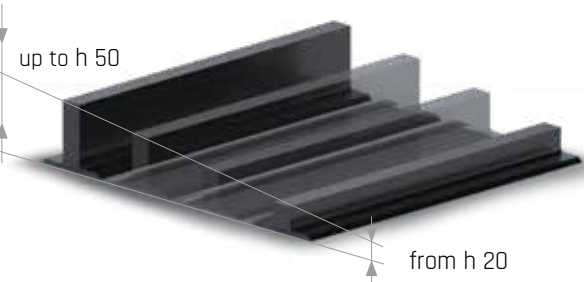

C

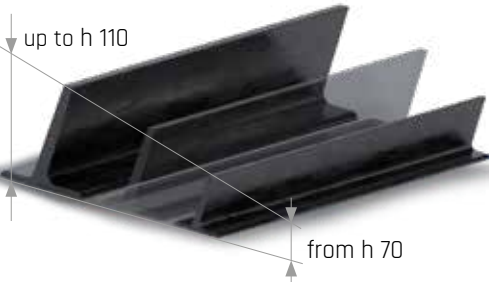



ACCESSORIES



ACCESSORIES

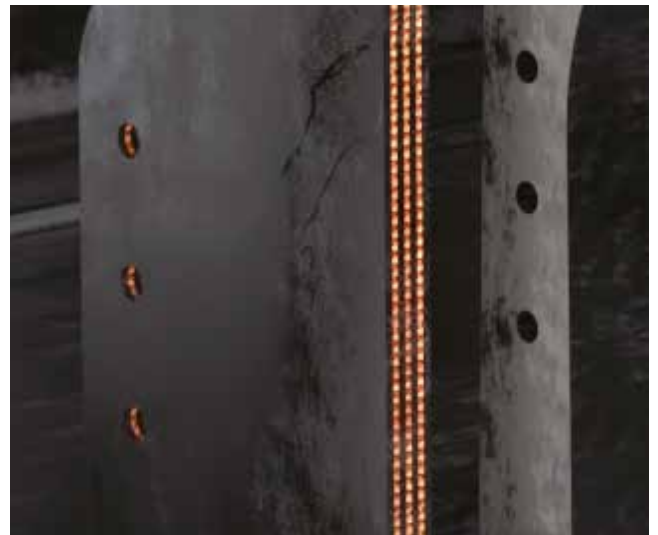



CONVEYOR BELTS



CONVEYOR BELT

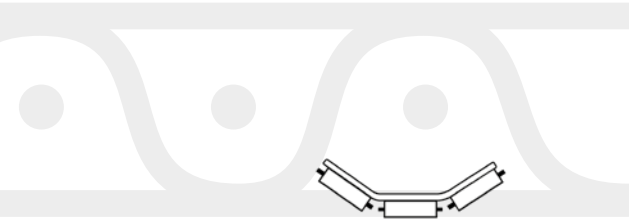

FLEXIBLE BELT



DUBLE COVER

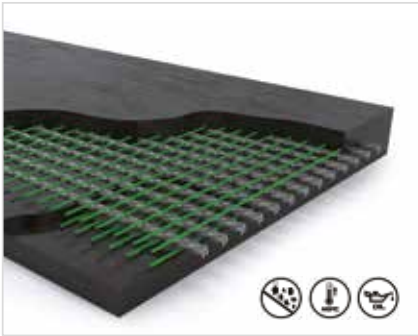
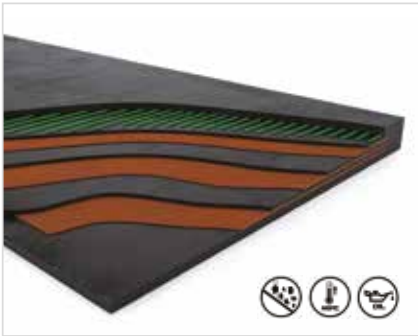

FLAT

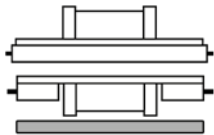

CROSS STABILIZED BELT

DUBLE COVER



FLAT



A photograph of a cable manufacturing machine. The machine features a series of vertical spindles and a complex arrangement of cables. A prominent blue semi-transparent overlay covers the right side of the image. The text 'PROCESSING STEPS' is centered within this overlay in white, bold, uppercase letters. The background shows the intricate mechanical components of the machine, including metal frames and various cables.

PROCESSING STEPS

RAW MATERIAL CONTROL

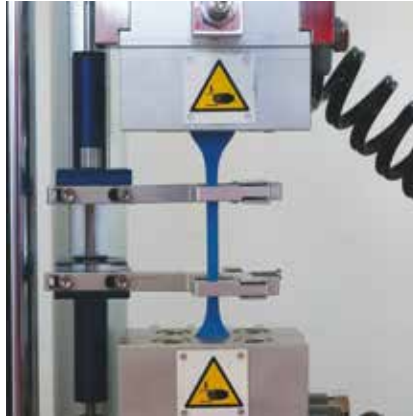

MOULDING PRODUCTION



SIDEWALLS AND CLEATS PREPARATION

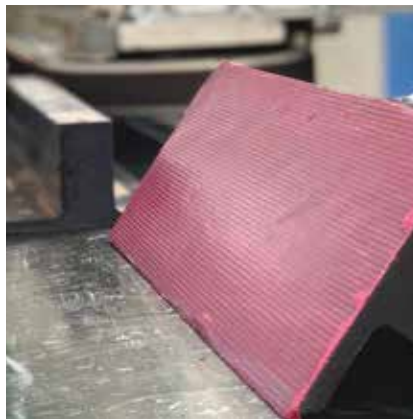

LASER MARKING



BELT GRINDING



HOT VULCANIZATION



PACKAGING



LAVORGOMMA
LAVORGOMMAGROUP

SHEBEL
DIVISION

SEALIC
DIVISION

MOULDIC
DIVISION

ROLLIC
DIVISION

Loc. Molino, 9/10
61026 Belforte all'Isauro (PU) IT
T. +39 0722 721352
info@lavorgommagroup.com
www.lavorgommagroup.com