

PT875

Continuous Direct Thermal Plotter



Users Guide

Rev. 2.0

INDEX		
INTRODUCTION		3
WHAT'S IN THE BOX		3
IMPORTANT INFORMATION		4
PRODUCT OVERVIEW		5 - 6
INSTALLATION		7
	Desktop	7
	19" Rack Mount	8
HOW TO's		9
	Power ON/OFF	9
	Load Media	10
	Run Test Plot	11
	Setup Network I/F	12
	Windows Driver Installation	13
REGULAR MAINTENANCE		14
	Clean The Thermal Print Head	14
	Clean The Platen Roller	15
MENU FUNCTIONS		16
	Print Menu	16
	Feed Menu	17
	Network Menu	18
	Calibration Menu	19
	Setup Menu	20 - 21
	Information Menu	22
WARRANTY		23
SPECIFICATIONS		24 - 25
APPENDIX A		26

INTRODUCTION:

Thank you for purchasing our PT875 Direct Thermal Plotter. Your new plotter was designed using the latest technologies, assembled with foreign parts and tested with pride in Canada. We are always looking to improve our products so any feedback is appreciated and will be taken into consideration.

WHAT'S IN THE BOX:

- PT875 Plotter
- 120VAC Power Cord
- USB to Ethernet Adaptor (Optional)
- Fanfold Output Basket (Optional)
- Roll Spindles (Optional)

NOTE: The User Guide and Drivers can be downloaded from www.flextecdigital.com website.

DISCLAIMER

FlexTec Digital Inc. makes no warranties as to the accuracy, validity or fitness for use of the contents of this manual. FlexTec Digital Inc. reserves the right to revise the information in this manual at any time without notice.

ATTENTION:

The PT875 plotter generates, uses and can radiate radio frequency energy and, if not installed and used in accordance with the instruction manual, may cause interference to radio communications. It has been designed to provide reasonable protection against such interference when operated in a commercial or industrial environment. Is not sold or intended for use by consumers or in a consumer environment. Operation of this equipment in a residential area is likely to cause interference in which case, the user, at their own expense, will be required to take whatever measures may be required to correct the interference.

Please refer to appendix A (Page 26) regarding EMI/EMC testing.

LIMITATION OF LIABILITY:

The FlexTec Digital Inc. total liability to the purchaser, or to any third party, for damages from any and all causes whatsoever, regardless of the form of action, whether in contract or in tort, including negligence, and any infringement of proprietary rights or any misappropriation or unlawful use of any proprietary rights or property of any third party shall, in the aggregate, be limited to purchase price actually paid by the purchaser for the product relating to the damages. The limitation of liability provisions of this agreement reflect an informed voluntary allocation of the risks (known and unknown) that may exist in connection with the provisions of the goods and services provided hereunder by FlexTec Digital Inc., and that such voluntary risk allocation represents a fundamental part of the agreement reached between FlexTec Digital Inc. and the purchaser. FlexTec Digital Inc. shall not be liable for any special, direct or indirect, incidental, consequential, exemplary, punitive or any similar or other damages of any nature suffered by the purchaser whatsoever including, without limitation, loss of use or lack of availability of the purchaser facilities, including its computer resources and any stored data, loss of profits or revenue, or other commercial loss, or any claim for contribution or indemnity in respect of any claims against the purchaser, regardless of whether FlexTec Digital Inc. has been advised of the possibility of such damages.

FlexTec Digital Inc.
Email: info@flextecdigital.com
Website: www.flextecdigital.com

PRODUCT OVERVIEW:

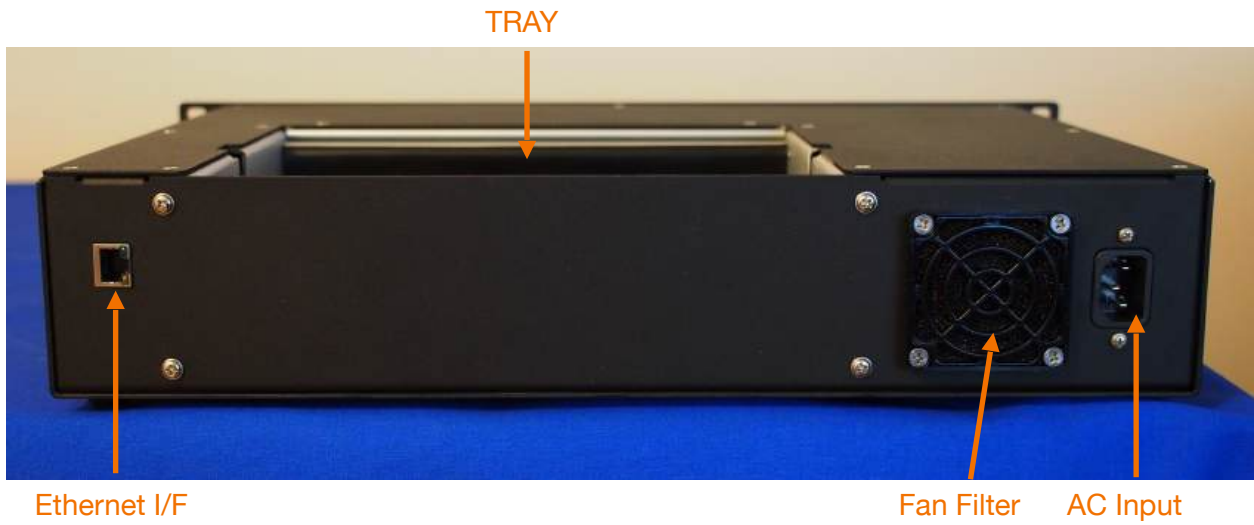
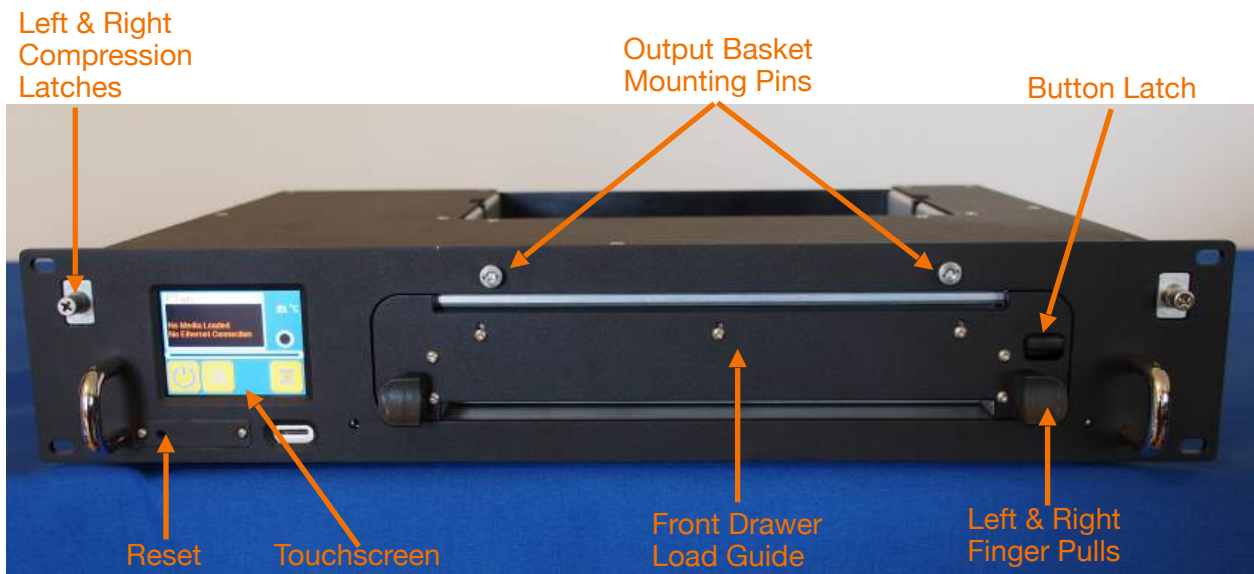

TOUCHSCREEN OVERVIEW

BUTTON FUNCTIONS:

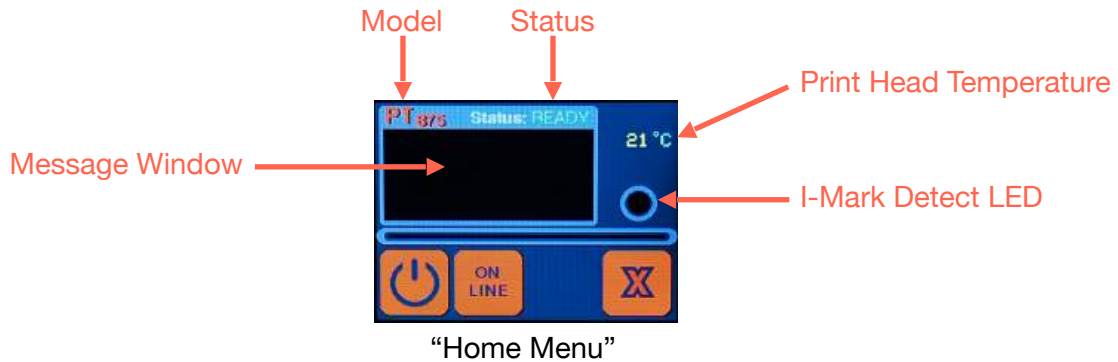

Note:

- If you do a short or quick touch on the button that will activate the button action one time (single touch).
- If you touch and hold the button that will continue to activate that button action until released (multi touch).



- Finger print icon, shows to **Touch** that button on the screen.



- Touch the **Power** button will take you to the "Power Menu" screen.



- Touch the **Online** button to take you to the "Offline Menu" screen. Plotter is Offline and Status "**BUSY**".



- Touch the **Offline** button to take you to the "Home Menu" screen and take the plotter back Online and Status "**READY**".



- Touch the **Cancel** button to kill the current job.



- Touch the **Settings** button to take you to the "Settings Menu" screen.



- Touch the **Previous** button to take you back one menu.



- Touch the **Home** button to store new values and go back to the "Offline Menu" screen.



- Touch the **Select** button to move or highlight the menu item to change.



- Touch the **Enter** button when finished changing that menu item.



- Touch the **Down** arrow button to scroll down through menu items.



- Touch the **Up** arrow button to scroll up through menu items.

INSTALLATION:

Desktop:

- Ensure the 4 rubber feet are installed on the bottom of the plotter.
- Place plotter on a solid stable surface.
- Place the plotter at the front edge of the surface to allow access to the load guide for loading media. Also allows room for the front re-folding basket to hang over the surface.
- Allow room at the front and back of the plotter for proper air flow and cooling.
- Do not place the plotter in direct sunlight.
- Do not place the plotter next to a heat source or vent.

Using Front Load Media Path (Note: Black I-Mark location - right)

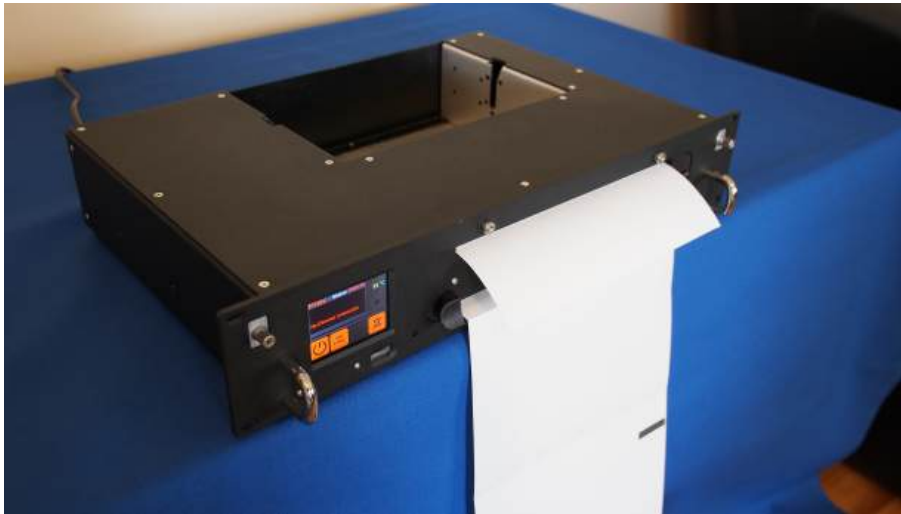

Using Rear Load Media Path (Note: Black I-Mark location - bottom right)

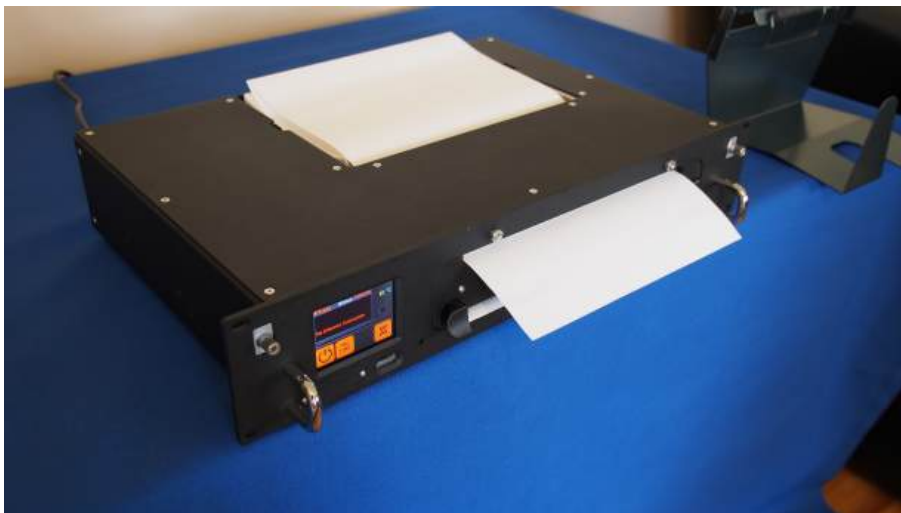

19" Rack Mount:

Using Front Load Media Path

- Remove the 4 bottom rubber feet - if installed.
- Slides are not required if using only front media loading.
- The plotter can be either hard mounted to the cabinet's front mounting left and right side rails or use Slides for mounting.
- Support extensions from the rear of the plotter to the rear mounting left and right side cabinets mounting rails are recommended.

Using Rear Load Media Path

NOTE: This plotter was designed to 19" rack mount using only General Device Slides Model C-300-S-1XX, S-Type series (2 Open Slots). They can be purchased at (www.generaldevices.com). Other types of rails may or may not work.

- Remove the 4 bottom rubber feet - if installed.
- Allow room at the front and back of the plotter for proper air flow and cooling.
- Any equipment mounted above the plotter must have a smooth bottom surface with no protruding screws or edges. When using fanfold media's in rear tray.
- When mounting slides to the cabinets front left and right side rails we recommend using flush mounting for either #10 or M5 flat head screws. This allows sufficient room for the plotter's compression latches to properly latch to secure the plotter chassis to the cabinets front left and right side mounting rails. (See Figure 1)
- Use M5 x 10mm Pan Head screws to mount the S-TYPE CHASSIS SECTION of the slides to the left and right sides of the plotter chassis.

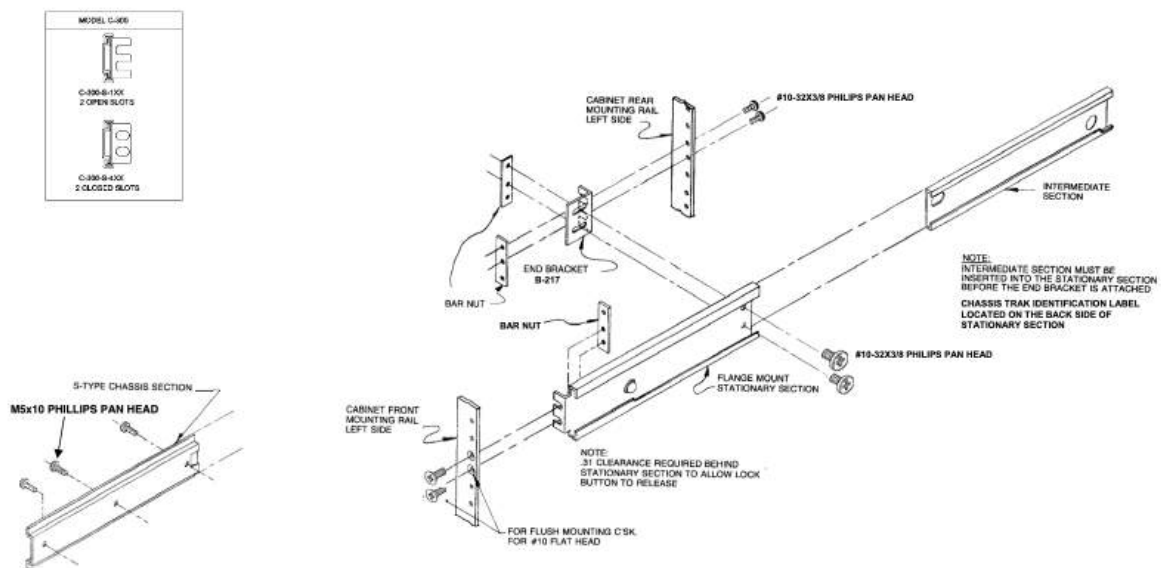

Figure 1

HOW TO:

AC Power Cord Plugged In:

- Initially when the plotters power cord is plugged in to the AC outlet the plotters touchscreen will display “Power Applied” then the touchscreen will display “Shut Down”.
- The touchscreen will then go blank and the plotter is now powered OFF

Power OFF & ON:

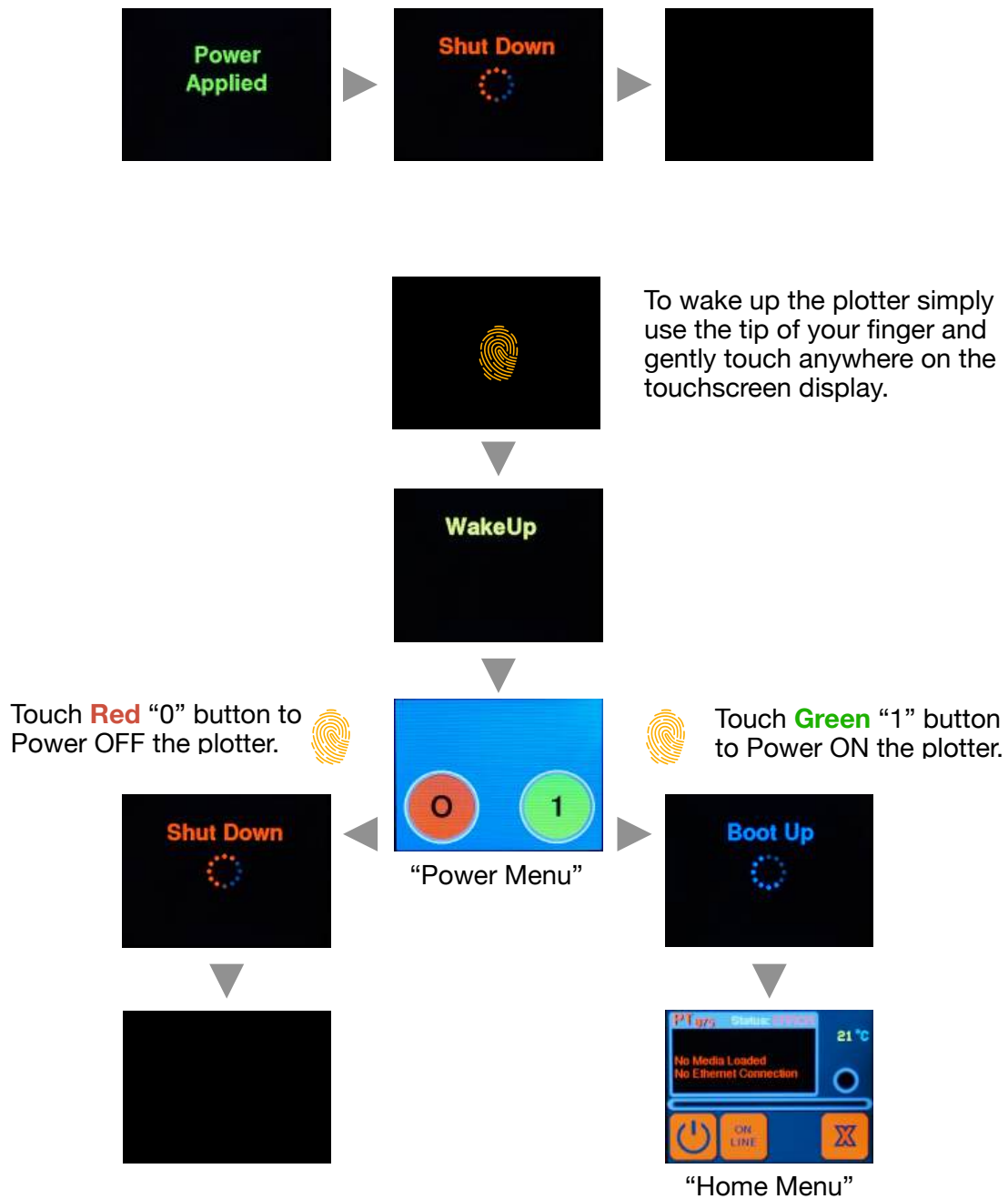

Load Media:

CAUTION: Do not attempt to plot or form feed without the print media installed. This may damage the print head or motor and will void the warranty.

- On the Front Drawer, Press the Button Latch to release the Front Drawer Load Guide and using both left & right finger pulls to slide out the load guide straight out towards you.

Note:

- If using roll paper ensure the roll can rotate freely when installed
Note: Total width of the roll must not exceed the maximum spec'd width.
- If using fanfold paper the first sheet loaded should have the black I-Mark on it for correct re-folding in the output basket. When loading fanfold paper the black I-Mark should be facing you and located on the right hand side of the media.

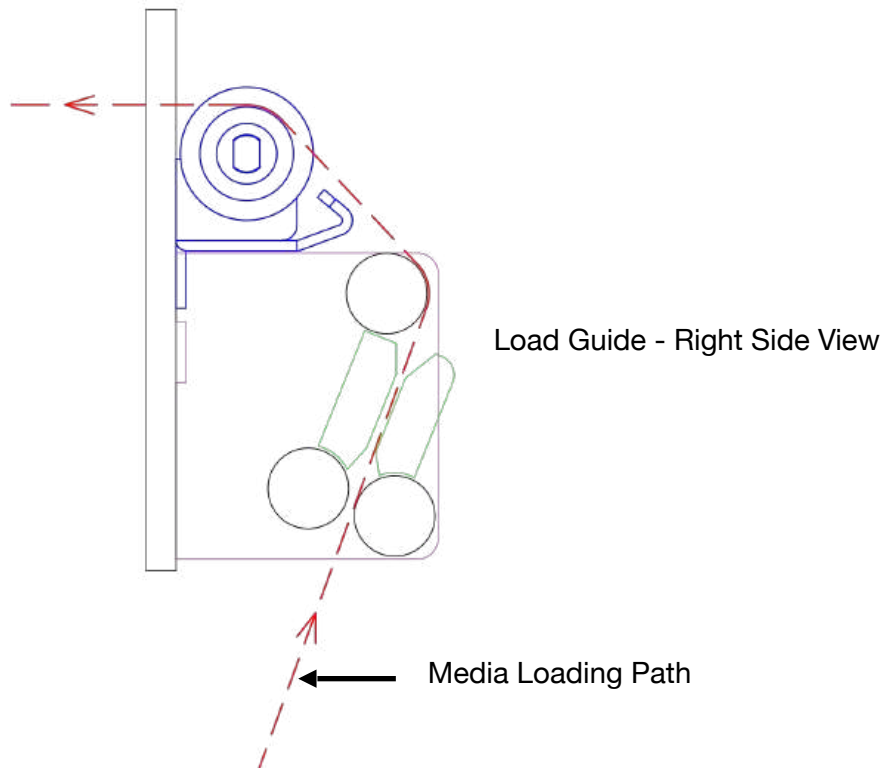







- Load the leading edge of the media between the bottom two rollers.
- Feed up the media until you can grab the media, pull the media over top of the rubber platen roller and towards you.
- **Note:** When loading keep the right edge of the media against the right guide.
- While holding the media straight slide the load guide inwards until it latches securely in place.

Run Test Plot

CAUTION: Do not attempt to plot or form feed without the print medium installed. This may damage the print head or motor and will void the warranty.

- Ensure there is media loaded and the load guide tray is closed and latched.
(no errors displayed on touchscreen)



-   - Touch the **Online** button to take the plotter to the "Offline Menu"
-   - Touch the Settings button this will take you to the "Settings Menu" screen.
-   - Touch the Test Plot button this will printout its internal test plot.

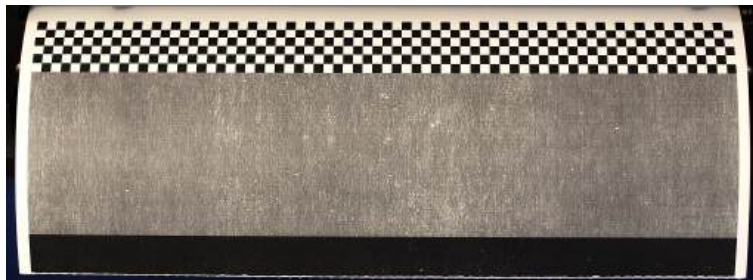

Sample Test Plot

Configure Network I/F









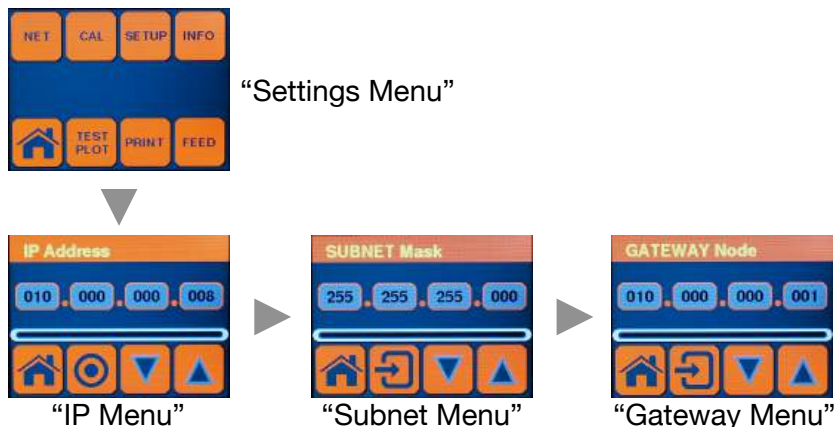



Note 1: Please contact your System Administrator for the following Network information needed to setup the PT875 plotters network interface to work on your network.

Note 2: Shielded ethernet cable is recommended.



For **Peer to Peer** or direct connecting the plotter to a PC:

- If the PC supports Auto MID/MDIX, you can use either direct or cross-cable to connect the plotter to the PC.
- If the PC does not support Auto MID/MDIX you will need to use a cross-cable to connect the plotter to the PC.

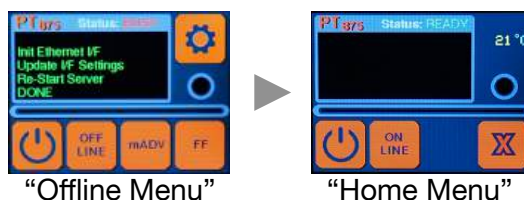

-   - Touch the **NET** button will take you to the “Network Menu”
-   - Touch the **SEL** button to highlight the menu item to change.
-   - Touch the **Up** arrow button to scroll up through menu items.
-   - Touch the **Down** arrow button to scroll down through menu items.
-   - Touch the **Enter** button when finished changing that menu item.
-   - Touch the **Home** button to store new values and go back to the “Offline Menu” screen.



- **Note:** The network interface will be re-configured with the new changes.
-   - Touch the **Offline** button will take you to the “Home Menu” screen and take the plotter back Online and Status “**READY**”.

Windows Driver Installation

Please goto the website - downloads section for "How To's" and videos.

REGULAR MAINTENANCE:

- The PT 875 thermal plotter is engineered to require minimal preventative maintenance. If the thermal printhead and platen roller are cleaned regularly, and the plotter is kept free of debris, extra maintenance should rarely be required.
- This minimal preventative maintenance is the customer's responsibility. Damage to the plotter that has in FlexTec Digital's opinion resulted from neglect or misuse will not be covered under warranty.

Clean The Thermal Printhead

- After prolonged use, the thermal printhead picks up residue from the thermal coating, dust and fibres from the media passing under it. This residue, dust and fine fibres collect and compact on portions of the printhead, blocking the contact it makes with the paper during a plot and causing poor print quality or faded patches. Poor contact between the printhead and paper may also cause the affected heating elements (nibs) to fail prematurely because of improper heat dissipation to the paper.

Note: Recommend cleaning the printhead every time you install a new roll or box of fan-fold paper. Using non-top coated media's may require more frequent cleaning of the print head.

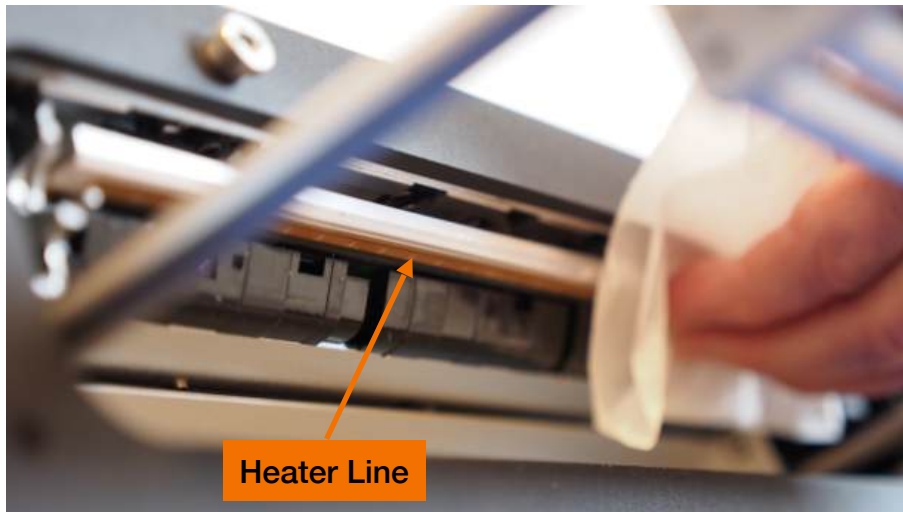

- Moisten (do not soak) a soft, lint-free cloth (Kim Wipe) or cotton swab (wood shaft) only using 99% pure isopropyl alcohol. **Note: Do not use water.**
- Rub gently along the length of the printhead's heater line, removing any buildup of residue on the printhead.
- Allow the alcohol to evaporate completely before using the plotter.

CAUTION: Do not touch the printhead with your fingers or other objects. The oil on your skin will contaminate the printhead, which diminishes plot quality and shortens the life span of the printhead.

Clean The Platen Roller

- After prolonged use, the platen roller picks up dust and fibres from the paper passing above it. This dust and fine fibres collect and compact on portions of the platen roller, creating bumps. The uneven surface of the roller may cause the printhead to contact the passing paper unevenly, producing a blotchy or faded plot. This debris could also cause slippage issues while moving the media.

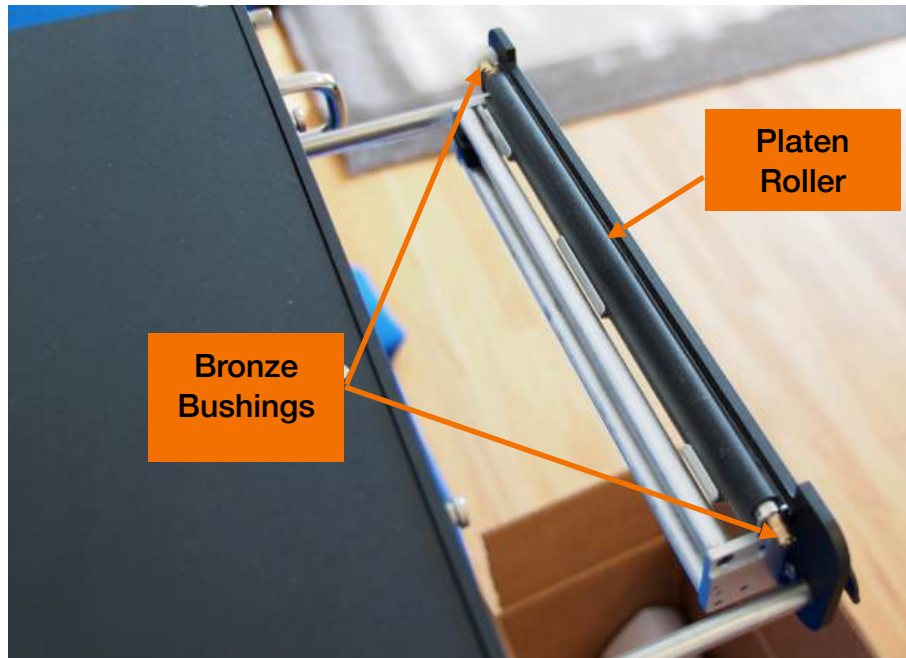

- Clean the platen rollers rubber surface when it appears dirty, or after cleaning the print head.
- Lightly wipe the roller with a soft, lint-free cloth moistened in 99% pure isopropyl alcohol, turning the roller as necessary to remove paper fragments and dust.

Lubricate The Platen Roller's Bronze Bushings

Note 1: Do not get oil on the rubber surface of the roller. This will damage the rubber coating.

Note 2: Only oil the left and right bronze bushings if the roller squeaks or does not rotate freely by hand. Only lubricate the inside diameter of the bushing.

Note 3: Only use standard 3 in 1 oil to lubricate the bushings.

- Place one drop of oil to lubricate the inside diameter of each bushing.
- Rotate the roller by hand it should rotate freely and smoothly.
- Clean the roller and wipe off any excess oil.



SETTINGS MENU FUNCTIONS:



PRINT Menu Items

Media Type

WARNING: Do not use direct thermal media's with high sodium content. Using non-qualified or media's with high sodium content will null and void your print head warranty.

- Used to select the correct Media Type that you are printing on.
- "Lite Paper", select when using thin fax papers
- "Heavy Paper", select when using 20lb paper or Top Coated papers
- "Lite Film", <= 3mil thickness (maximum)
- Default = Lite Paper

Contrast

WARNING: When adjusting the contrast only adjust it to get the desired results with the media your are printing on. If you set the contrast too high the media's thermal coating will start to over burn causing:

- poor print quality, blurry or grey looking images
- early over temperature conditions
- shortened print head life
- print head warranty could be void

- Used to adjust the image density.
- Range = (lighter) -10 ~ 0 ~ +10 (darker)
- Default = 0

Speed

- Used to adjust the Speed at which the image is printed at.
- For best image quality pick a lower printing speed.
- "Low" = 12.7mm/sec [0.5"/sec]
- "Med" = 25.4mm/sec [1"/sec]
- "High" = 50.8mm/sec [2"/sec]
- Default = Low



FEED Menu Items

FF Mode

- Used to select - no form feed - or when to do the form feed.
- “No FF”, no form feed will be done.
- “Start of Job”, do a form feed before the job starts printing.
- “End of Job”, do a form feed after the job has completed printing.
- Default = End of Job

FF Length

- Used to adjust the distance the media is moved on a form feed.
- Range = 0 ~ 16” or 0 ~ 406.4mm, increments of 0.5” or 12.7mm
- Default = 0.5” or 12.7mm
- **Note:** If using **TOF Sense** to detect the black mark your **FF Length** must be set longer than the distance between two black marks. Typical setting would be 13” or 330.2mm FF Length.

TOF Sense

- Used to select which sensor to use
- “No TOF”, sensors turned off and not used
- “Bot TOF”, bottom side sensor is selected to be used
- “Top TOF”, top side sensor is selected to be used
- Default = No TOF

TOF Advance

- Used to adjust the distance to move after the TOF mark was detected to set the top-of-form print start position.
- Range = 0 ~ 16” or 0 ~ 406.4mm, increments of 0.125” or 3.175mm
- Default = 0.375” or 9.5mm



NET Menu Items

NOTE: Please contact your System Administrator for the following Network information needed to setup the PT875 plotters network interface to work on your network.

IP Address

- Used to set the Static IP Address.
- Default IP Address = 10.0.0.8

SUBNET Mask

- Used to set the SUBNET Mask.
- Default SUBNET Mask = 255. 255. 255. 0

GATEWAY Node

- Used to set the GATEWAY Node.
- Default GATEWAY Node = 10.0.0.1
- For most networks set the Gateway to the same as IP Address



Calibration Menu Items

Scale

- Used to adjust for mechanical variances or as the platen roller ages.
- Scale in the vertical distance measured over the Scale Length.
- negative (image is too long)
- positive (image is too short).
- Range = $-0.4\text{mm} \sim 0 \sim +0.4\text{mm}$ [$-1/64'' \sim 0 \sim +1/64''$]
- Default = 0.

Scale Length

- Used for the length or distance to scale over. Default = 914.4mm [36"]
- Range = $0 \sim +914.4\text{mm}$ [$0 \sim +36''$]
- Default = 914.4mm [36"].

Bottom Sensor

- Sensor auto calibrates and should never need to be manually calibrated.

Top Sensor

- Sensor auto calibrates and should never need to be manually calibrated.



Setup Menu Items

Job Header

- If set to “Use Header” the plotter will use the settings sent by the windows driver.
- If set to “No Header” the plotter settings will be used.
- Default = Use Header

Color Mode

- If set to “Bi-Modal” the plotter will print monochrome (black and white).
- If set to “8 Levels, 16, Levels, 32 Levels or 64 Levels” the plotter will print in continuous tone or grayscale at that number of levels.

Notes:

- all files must be created using the plotters Windows Driver.
- continuous tone or grayscale modes print at very slow rate. The higher the number of levels the slower it will print.
- Default = Bi-Modal

Image Mode

- If set to “Normal” the plotter will print the image normally.
- If set to “Mirror” this mode is not available in the plotter. Mirror mode is only a function of the Windows Driver.
- Default = Normal

PreBuffer

- If set to “No” the plotter will not buffer any data coming from the PC. This would be used for single trace printing one scan at a time.
- If set to “Yes” the plotter will pre-buffer data at the beginning of the job
- Default = Yes

Units

- If set to “Imperial” then all displayed values are in [inches, deg F, miles].
- If set to “Metric” then all displayed values are in [mm, deg C, km]
- Default = Metric

Temperature Set Point

- Used to pre-heat the cold print head to a set temperature before printing.
- To disable this feature adjust the set point temperature to less than the the plotters current ambient temperature reading.
- Range = -40 ~ +40 degrees C or -40 ~ +104 degrees F
- Default = 20 degrees C or 68 degrees F

Touchscreen Backlight

- Used to adjust the LED backlight of the touchscreen.
- Range = 2 (less bright) ~ 255 (more bright)
- Default = 255

Touch Sensitivity

- Used to adjust the touch pressure or sensitivity of the touch panel.
- Range = 0 (less sensitive) ~ 255 (more sensitive)
- Default = 20

Note:

- If you do a short or quick touch on the button that will activate the button action one time (single touch).
- If you touch and hold the button that will continue to activate that button action until released (multi touch).

Factory Defaults

- Used to set all the plotter settings back to the factory defaults.
- if set to “No” no changes will be made to settings saved in eeprom.
- If set to “Yes” this will over write all user settings and set all the plotter settings back to factory defaults.
- Default = No



Information Menu Item

- This will display all the important plotter information in one page.



Note: A clear picture of the plotter’s “**Information**” screen will be requested for any product warranty service, repairs and or parts.

WARRANTY

FlexTec Digital Inc. products are warranted to be free from failures due to defects in material or workmanship for twelve (12) months from the original date of purchase. During this 12 month period, FlexTec Digital Inc. will, at its sole discretion, repair or replace at no charge the product, which in its opinion, is defective.

If the product has been modified without FlexTec Digital Inc. consent or if the failure is the result of misuse, abuse or misapplication, this warranty obligation is null and void.

FlexTec Digital Inc. warrants that the thermal print head will be free from defects in material or workmanship for the expected life of the print head but for not more than one (1) year from the date of purchase.

NOTE: Using thermal media's with high sodium content will void the printhead warranty.

Consumables Warranty

The print head is a consumable because it wears as media passes under it and as it receives electrical pulses. The expected life of a thermal print head is the passage of 50 KM (approximately 31 miles) of media (paper) or 100 million pulses in any head nib element. Therefore the warranty is pro rated over the expected life of the head.

Print heads returned for warranty replacement will have the following credits applied:

Up to 3 months use = 100%
Between 3 and 6 months = 75%
Between 6 and 9 months = 50%
Between 9 and 12 months = 25%
More than 12 months = 0% - expired warranty

Except as provided above, the hardware and accompanying written material, including this User Guide, are provided "as is" without warranty of any kind, including the implied warranties of merchantability and fitness for a particular purpose, even if FlexTec Digital Inc. has been advised of that purpose. In no event will FlexTec Digital Inc. be liable for any direct, indirect, consequential or incidental damages arising out of the use or inability to use such product even if FlexTec Digital Inc. has been advised of such damages.

Obtaining Service

Before returning a failed unit, the buyer must first obtain a Return Material Authorization (RMA) number by contacting FlexTec Digital Inc. Customer Service. The RMA number should be prominently displayed on the outside of the returned package and on the accompanying packing list. FlexTec Digital Inc. cannot be held responsible for any package returned without an RMA number. The model and serial number of the plotter are on the chassis label, which is located on the rear of the plotter. Please have this information available when service is required.

Note: A clear picture of the plotter's "**Information**" screen will also be requested for any product warranty service, repairs and or parts.

You are responsible for packing the failed product in original or equivalent packaging for shipment, and for the charges to ship the failed product to FlexTec Digital Inc. FlexTec Digital Inc. is responsible for charges to ship the repaired or replaced product if under warranty. If any charge to you is involved, FlexTec Digital Inc., at its sole option, will bill you or return the product C.O.D.

Self Service

FlexTec Digital Inc. recognizes that some customers have service departments that are capable of servicing the FlexTec Digital Inc. products. For this case, FlexTec Digital Inc. offers a Self Service Reference. This reference includes photo's or drawings of FRU's (field replaceable units) so that replaceable internal components can be identified and ordered. Please contact FlexTec Digital Inc. Customer Service to obtain a Self Service Reference for your product(s). For self service, the owner assumes all liability, responsibility and the risk of damage to the unit or replacement parts which may void the warranty.

SPECIFICATIONS	
User Front Display	TFT LCD Touchscreen
Print Head Technology	Direct Thermal
Resolution	8 dots/mm [203 dpi]
Printed Image Width	216mm [8.5"] Maximum
Media Width	222.25mm [8.75"] Maximum
Rear Tray Capacity	
Fanfold	Up To 800 sheets or <= 70mm [2.75"] stack height Maximum
Roll	Up To 80mm OD [3.15" OD] Maximum
Media Loading	
Front Load	Fanfold
Rear Load	Fanfold and or Roll
Sensors	
Top TOF	Black Mark Detection
Bottom TOF	Black Mark Detection
Media Out	Media Out Detection
Load Guide Tray	Open / Closed Detection
Print Head	Temperature Feedback, Over Temperature
Motor	Temperature Feedback
Print Modes	
Bi-Modal	1 level (Monochrome)
Grayscale	8, 16, 32, 64 Levels (Continuous Tone)

SPECIFICATIONS	
Mirror	Bi-Modal, Grayscale (Driver only)
Remove Blank Space	None, Top Only, Bottom Only, Top and Bottom (Driver only)
Print Speeds	
Low	12.7mm/sec [0.5"/sec]
Med	25.4mm/sec [1"/sec]
High	50.8mm/sec [2"/sec]
Interface	
Network	10/100 Mb Ethernet Port
USB	USB3.0 to Ethernet Adaptor (Optional)
Windows Drivers	
	Windows 7, 8 & 10
Power Requirements	
Input Voltage	100 ~ 240 VAC, 47~63Hz (Auto Sense)
Current	4.3A/115VAC 2.15A/230VAC
Power	495W Maximum
Environment	
Operating Temperature	0 ~ +50 Deg C [32 ~ 122 Deg F]
Operating Humidity	20% ~ 85% RH (non condensing)
Storage Temperature	-25 ~ +80 Deg C [-13 ~ 176 Deg F]
Storage Humidity	5% ~ 90% RH (non condensing)
Dimensions (W x D x H)	
19" Rackmount	482.6mm x 300mm x 88.9mm [19" x 11.8" x 3.5"]
Desktop	482.6mm x 300mm x 88.9mm [19" x 11.8" x 3.5"]
Accessories (Optional)	
	Fanfold Output Basket, Roll Spindles

Note: Specifications are subject to change without notice.

APPENDIX A

Statements regarding RoHS and Pb Free

- Our products are designed to meet RoHS compliance
- If you have specific questions we urge you to contact the factory for details.

Statements regarding EMI / EMC testing

- Our equipment is marketed only to the oil & gas related industries.
- Users of our equipment are intended to be qualified engineers and technicians.
- Our equipment is intended for use in an industrial environment.
- Our equipment is intended to be test equipment.
- Our equipment requires integration with other test equipment to function. At a minimum a computer and a 'unit under test' are required. The 'unit under test' may be a module, several modules, an entire motor vehicle, or similar test set-up.
- Our equipment is not intended for use by consumers or in a consumer environment.
- We do not sell to individual consumers.

United States

The governing body is the FCC (Federal Communications Commission). **Point #1**
The controlling law is Title 47, Code of Federal Regulations, Part 15 "Radio Frequency Devices".

We state that our equipment is classified as a: "Class A Digital Device."
We cite 47 CFR, Part 15, Subpart A, section 15.3 "Definitions", paragraph (h): "Class A digital device. A digital device that is marketed for use in a commercial, industrial or business environment, exclusive of a device which is marketed for use by the general public or is intended to be used in the home."

Additionally, our equipment is considered an un-intentional radiator.

We state that our equipment is exempt from the certification requirements of Part 15.
We cite 47 CFR, Part 15, Subpart B, section 15.103 "Exempted Devices", paragraph (c): "A digital device used exclusively as industrial, commercial, or medical test equipment."

We do not test our equipment to meet any requirements of 47 CFR Part 15.

Point #2

The controlling law is Title 47, Code of Federal Regulations, Part 18 "Industrial, Scientific, and Medical Equipment".

We cite 47 CFR, Part 18, Subpart A, section 18.115 "Elimination and investigation of harmful interference".
The user assumes responsibility for eliminating the source of harmful interference.

European Union

The governing body is the European Community (and its various bodies).

Point #1

The governing Directive is: EMC Directive (89/336/EEC including all amendments).
We do not test our equipment to meet this directive. (See Point #3, below.)

Point #2

The governing Directive is: Low Voltage Directive (73/23/EEC including all amendments).
We do not test our equipment to meet this directive. (See Point #3, below.)

Point #3

Our equipment can only be sold and exported to EU customers under very narrow terms.
Our equipment has no intrinsic function (it requires other equipment with which to work).
Our equipment is considered a component of a larger equipment item or system.
The customer is responsible for integrating our equipment into their equipment or system.
The customer is responsible for all subsequent testing and certification of the resulting equipment or system.