

TRIM GUIDE

A complete line of matching Color-Coated, Galvanized, and Galvalume® trims and accessories ideal for finishing any project.

14" Universal Ridge Flashing

26ga Bare Code: 5500641 (10'-6")
26ga Ptd. Code: 55006XX (10'-6")

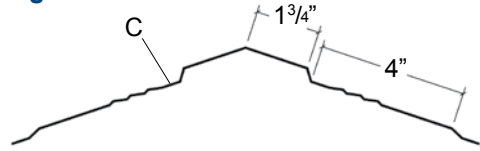

1

20" Ridge Cap

26ga Bare Code: 5500641
26ga Ptd. Code: 55006XX

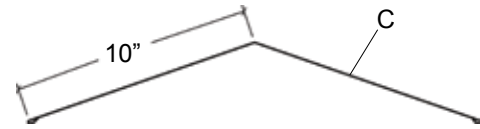

1

R-Panel Rake/Gable Trim

26ga Bare Code: 5591141
26ga Ptd. Code: 55911XX

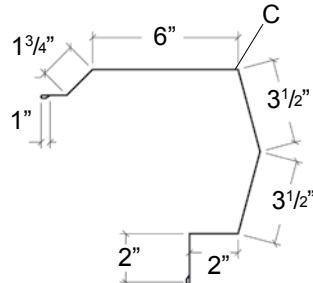

2

IC72 Rake/Gable Trim

26ga Bare Code: 5504241
26ga Ptd. Code: 55042XX

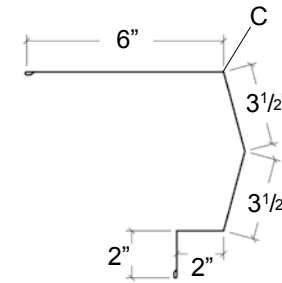

2

Classic Rib Rake/Gable Trim

29ga Bare Code: 4207141
29ga Ptd. Code: 42071XX

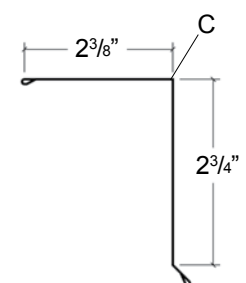

2

PBR-Panel Rake Trim

26ga Bare Code: 5519641
26ga Ptd. Code: 55196XX

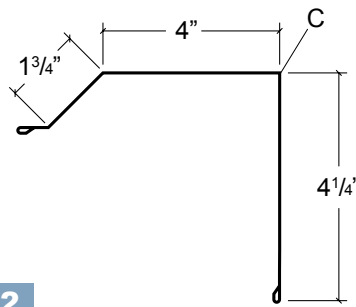

2

Pitch Break Trim

29ga Bare Code: 5304641
29ga Ptd. Code: 53046XX
26ga Bare Code: 5504841
26ga Ptd. Code: 55048XX

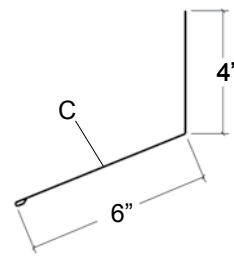

3

R-Panel Outside Corner Trim

26ga Bare Code: 5591441
26ga Ptd. Code: 55914XX

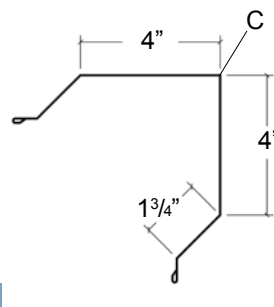

4

Classic Rib Outside Corner Trim

29ga Bare Code: 4216341 (10'-6")
29ga Ptd. Code: 42163XX (10'-6")
29ga Bare Code: 4216441 (12'-0")
29ga Ptd. Code: 42164XX (12'-0")

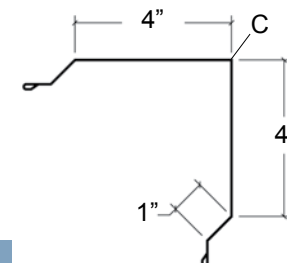

4

IC72 Outside Corner Trim

26ga Bare Code: 5513241
26ga Ptd. Code: 55132XX

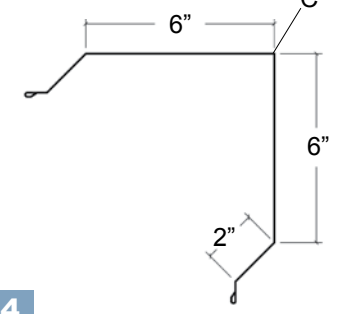

4

Sculptured Gutter

29ga Bare Code: 5581541
29ga Ptd. Code: 55816XX
26ga Bare Code: 5508441
26ga Ptd. Code: 55084XX

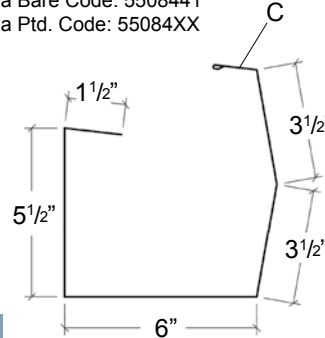

6

Box Gutter

29ga Bare Code: 5507641
29ga Ptd. Code: 55076XX
26ga Bare Code: 5507741
26ga Ptd. Code: 55077XX

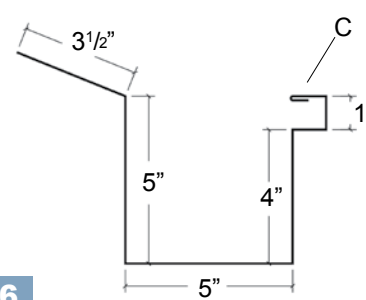

6

4" x 3.5" Downspout

26ga Bare Code: 5509441
26ga Ptd. Code: 55094XX

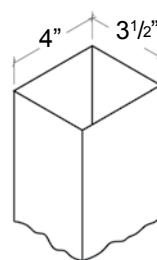

7

Eave Flashing - 29ga

29ga Bare Code: 4204841 (10'-6")
29ga Ptd. Code: 42048XX (10'-6")
29ga Bare Code: 4908041 (12'-0")
29ga Ptd. Code: 49080XX (12'-0")

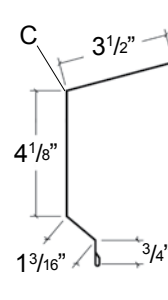

8

Eave Flashing - 26ga

26ga Bare Code: 5506941
26ga Ptd. Code: 55069XX

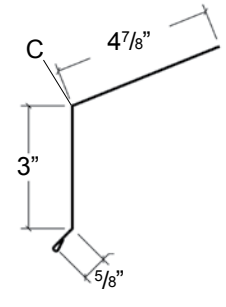

8

4.25" PA Door Jamb Trim

14ga Gav. Code: 3212400

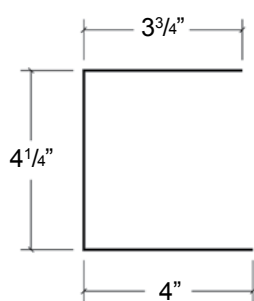

9

6.25" PA Door Jamb Trim

14ga Gav. Code: 3212600

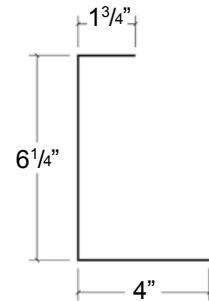

9

R-Panel Head/Jamb Trim

26ga Bare Code: 5520841 (Sellersburg)
26ga Ptd. Code: 55208XX (Sellersburg)
29ga Bare Code: 5591341 (Woodland)
29ga Ptd. Code: 55913XX (Woodland)

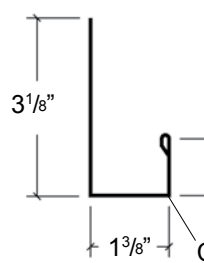

10

IC72 Head/Jamb Trim

26ga Bare Code: 5540641
26ga Ptd. Code: 55406XX

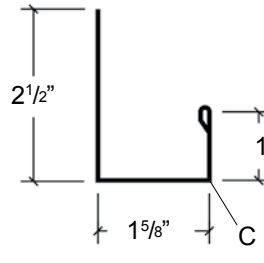

10

Classic Rib Head/Jamb Trim

29ga Bare Code: 4227441
29ga Ptd. Code: 42274XX

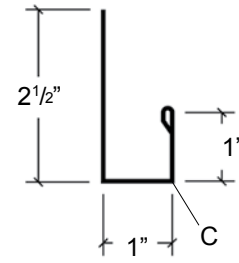

10

4-1/8" Mullion Capping - Head/Jamb Cover

26ga Bare Code: 4003941
26ga Ptd. Code: 40039XX

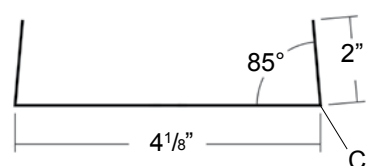

11

6-1/8" Mullion Capping - Head/Jamb Cover

26ga Bare Code: 4004041
26ga Ptd. Code: 40040XX

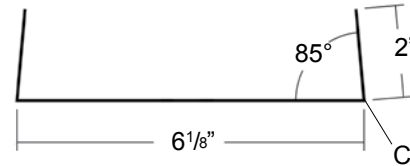

11

Universal Gambrel Trim

29ga Bare Code: 4252541 26ga Bare Code: 4252641
29ga Ptd. Code: 42525XX 26ga Ptd. Code: 42526XX

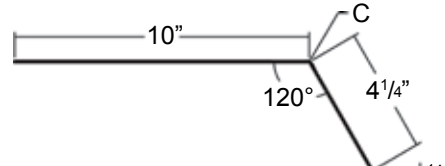

12

Base Trim

26ga Bare Code: 5513841
26ga Ptd. Code: 55138XX

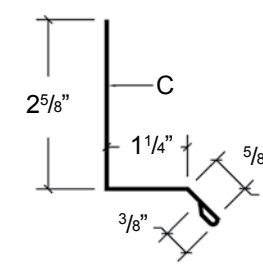

13

Typical Details

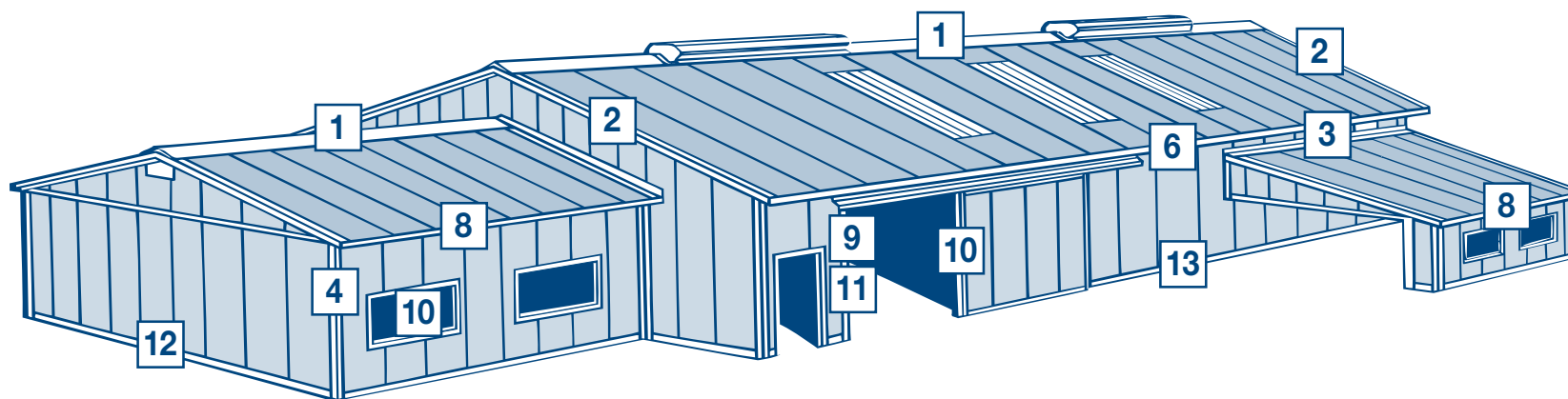

Downspout - Dropout

26ga Bare Code: 5510799

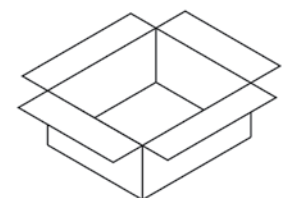

14

NOTE: 29 ga Trims shall be provided in 10'-6" lengths unless noted otherwise
26 ga Trims shall be provided in 10'-2" lengths unless noted otherwise