

VISHNU APPLIANCE

Cross Domain Solution

Tony Marshall

240-463-6494

tonymarshall@agecds.com

Streaming Your Data Real Time At The Speed Of The Warfare To The Edge

VISHNU Appliance At A Glance

- NCDSMO Certified
 - Only tested appliance that will be on the baseline
- Single Appliance Installation
- Partnered with HPE to build the hardware
- RTB Compliant
 - RTB - TPR-6 The CDS Vendors shall be responsible for sourcing the hardware for the installations.
- Multiple Configuration Options
- Built-In Data Conversion Engine
- Fast processing times
- Bi-directional (Receive & Deliver)
- Can receive multiple data sources



Streaming Your Data Real Time At The Speed Of The Warfare To The Edge

Delivering Data to the Edge

- Ingest data from sources at the appropriate classification
- Data transformation from the source and destination
- Enables **Faster Sharing** between classification domains
- Machine-to-Machine Streaming data in real time
- Supports multiple protocols (HTTP, SFTP, TCP, JMS, etc.)
- No replication of data to higher classified networks
- Decrease hardware from standard 4 servers to one 2U device
- Lower cost of ownership



Streaming Your Data Real Time At The Speed Of The Warfare To The Edge

VISHNU Data Exchange Engine (CDS)

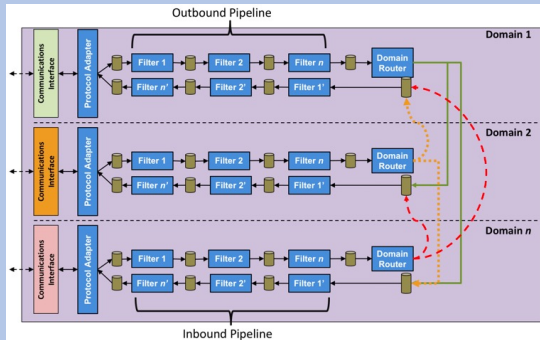

- Fully equipped with all the filters and security protocols
- Direct Data Pipeline increases speed
- Delivering Data to the Edge Fast and Protected

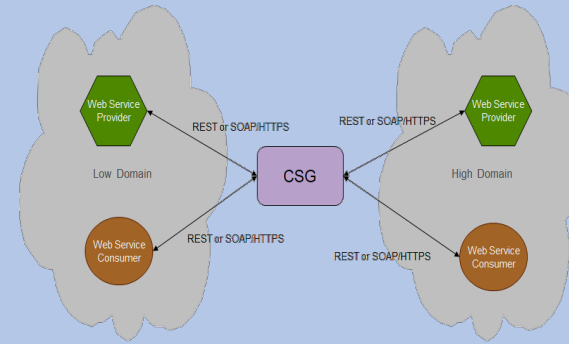

- Bi-Directional
- Connect up to 6 domains
- Collects all the audit, performance, system metrics
- Supports remote management



- RTB Compliant
- Compliant with DISA STIG
- Validation Checking
- Security Compliance Paperwork
- Fast Deployment



- Stores digital certificates, licenses and definitions files
- Can be configured for enterprise deployment
- Cost savings on hardware and implementation



Streaming Your Data Real Time At The Speed Of The Warfare To The Edge

Data Conversion Node

- NODES are 100% independent
- Use of Container technology = Scale to meet the Speed of change
- Supports modifications without the need for recertification
- NODES are based on X86 64 Bit Architecture
- Each NODE has up to 256 Virtual Cores
- **Scalable** unified Hardware Infrastructure to keep up with the speed of the warfare
- **Reduces Cost** of deployment



Streaming Your Data Real Time At The Speed Of The Warfare To The Edge

VISHNU Dashboard

- Provide Information At -a-Glance
- A collection of charts, graphs, metrics, searches, and maps that have been collected together onto a single pane
- Users can drill down into the details
- Customize How You want to see your data and design your reports
- Log and real time-series analytics
- Application monitoring
- Operational intelligence use cases

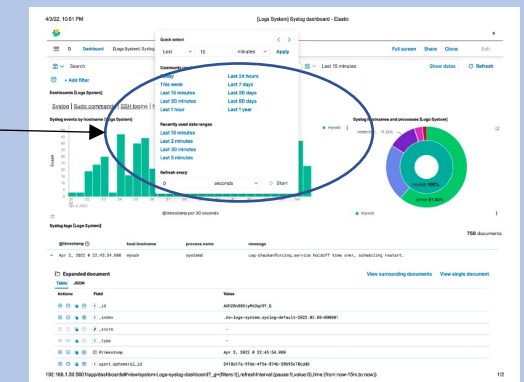
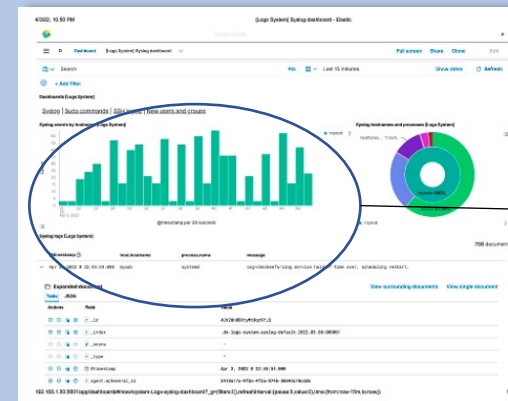
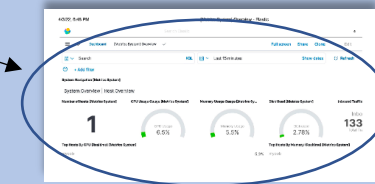
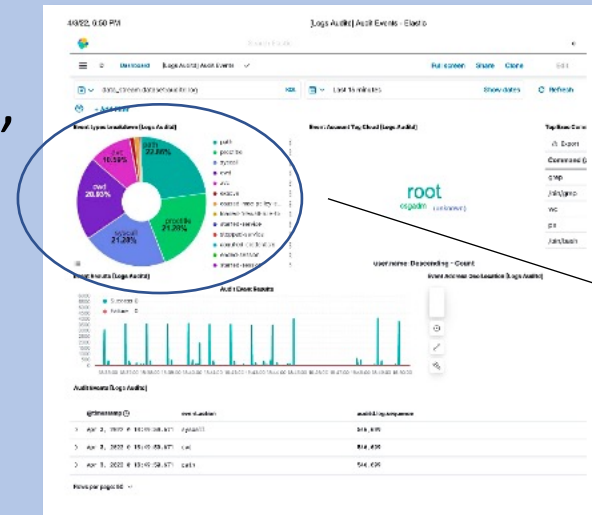

Streaming Your Data Real Time At The Speed Of The Warfare To The Edge

VISHNU E-Learning Center

- Cost Effective
- Time Efficient
- Easily adaptable, yet consistent
- Self Paced
- Everywhere Learning – not limited by place or time
- Generates recognized NCDSMO certificate
- Annual reminder of certificate renewal
- Trouble ticket management
- CDS administrators collaboration center

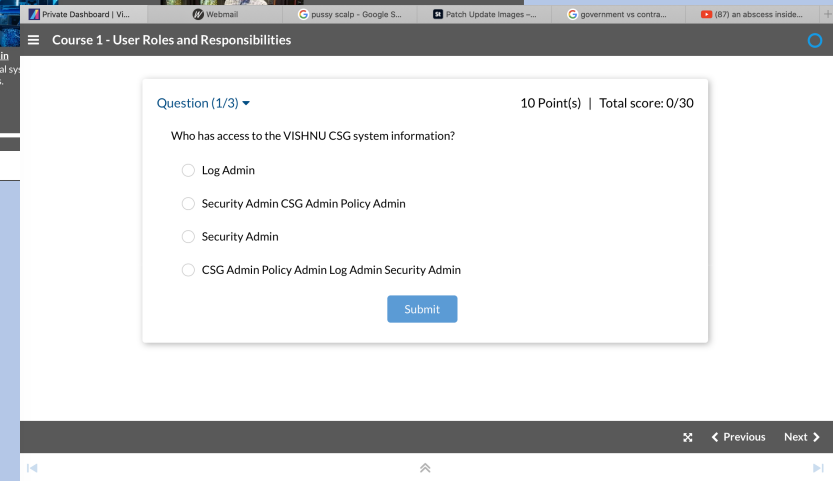
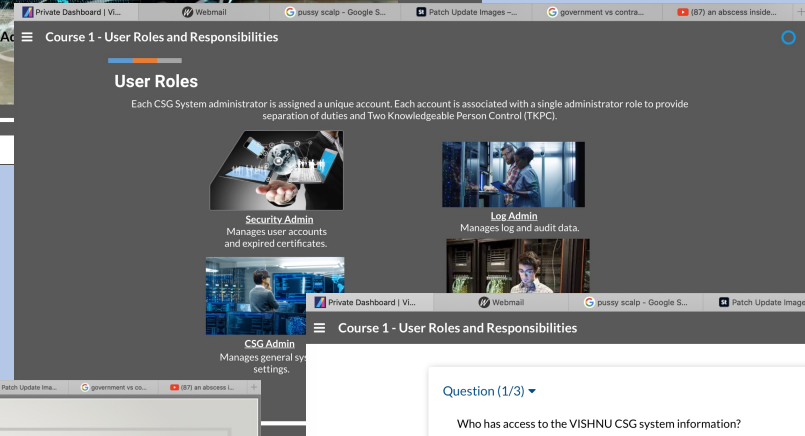
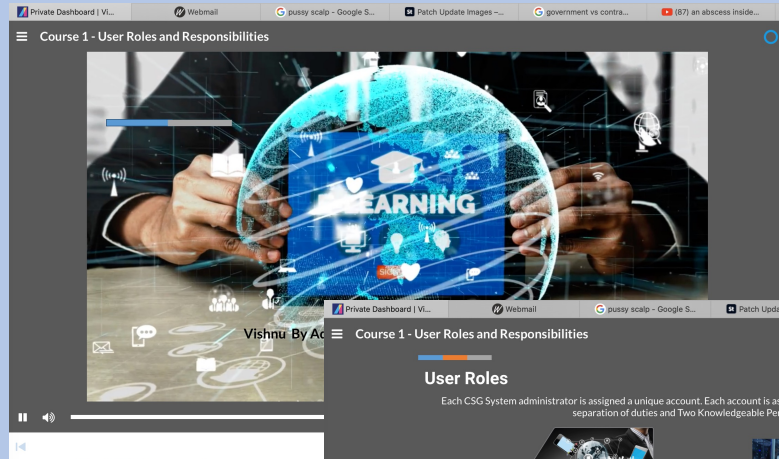

Streaming Your Data Real Time At The Speed Of The Warfare To The Edge

Value Proposition

- Reduction in Hardware to deploy
 - RTB - TPR-6 The CDS Vendors shall be responsible for sourcing the hardware for the installations.
- Increase in compute and storage density
- Reduced deployment time
- Data processing can be customized and deployed in real time without recertification
- Data processing recertification cost
- Scales easily
- Faster ATO Process
- Performance and Metrics data dashboard



Streaming Your Data Real Time At The Speed Of The Warfare To The Edge

Typical Deployment

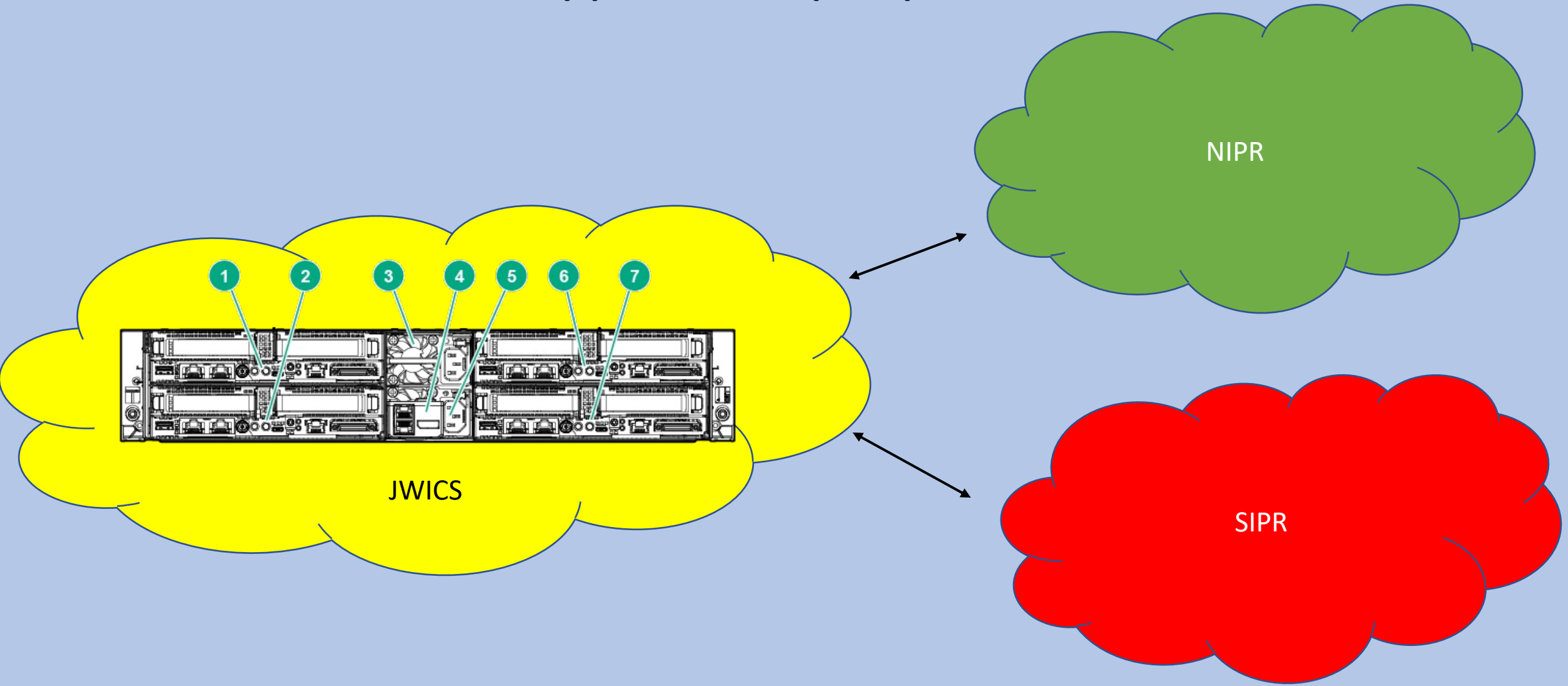

Streaming Your Data Real Time At The Speed Of The Warfare To The Edge

ABOUT AGE CYBER SECURITY SOLUTIONS

- Established in 2005
- Over 10 years in Cross Domain Solutions Development
- Cross Domain Solution SME's
 - Interface weekly with National Cross Domain Solution Office (NCDSMO) on issues related to CDS Design & Development
 - Raise The Bar (RTB) Compliance SME's
- Experience in Deployment, Training for the following customers
 - NSA
 - Air Force
 - Canadian Security Establishment
 - Australian Department of Defense

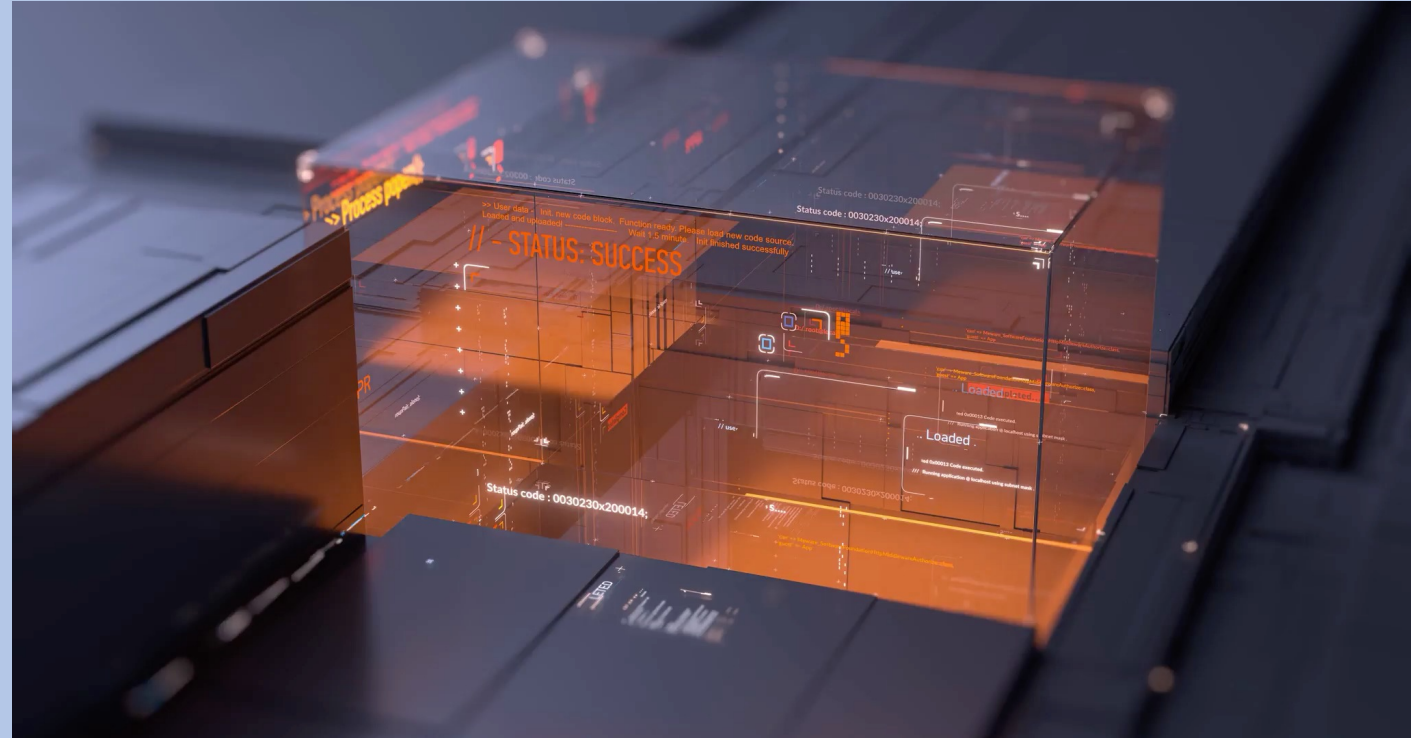

Streaming Your Data Real Time At The Speed Of The Warfare To The Edge