

# MATTEURS

SUSTAINABLE WASTE MADE BEAUTIFUL



INTRODUCING

COTTON

STONE

VASE

COLLECTION

MATTEURS

SUSTAINABLE WASTE MADE BEAUTIFUL

## COTTON STONE VASE COLLECTION

Cotton Stone™ is the result of years of research into how to use the cotton waste created by India's growing fashion industry. And as the world's fastest growing apparel market it's a problem that's not going away.

We're playing our small part by using the cotton scrap from clothing factories and transforming it into earthenware style products that are biodegradable, lightweight, shatterproof and beautiful.

By upcycling waste in this way, not only are we reducing post-manufacturing waste, we're reducing demand for mass produced traditional earthenware products.

MOTTEURS



COTTON STONE VASE COLLECTION





COTTON STONE VASE COLLECTION

SHATTERPROOF

LIGHTWEIGHT

100% UPCYCLED COTTON

WATER RESISTANT

NON-SCRATCH

BIODEGRADABLE

SUSTAINABLY HAND CRAFTED

COTTON STONE VASE COLLECTION



COTTON STONE VASE COLLECTION



We manufacture our products in green-energy factories that support local women with reliable, fair and ethically managed employment.

MATTEURS

## COTTON STONE VASE COLLECTION

### SHATTERPROOF

Unlike our delicate earthenware cousins, our vases can be dropped from a great height without any risk of breakage. Think of this as a insurance policy, against children and shipping companies.

### 100% UPCYCLED COTTON

We take industrial cotton waste from the fashion industry and upcycle it into beautiful objects worthy of collection. All made with GRS Certification.

### SUPER SUSTAINABLE

We are made with sustainable cotton. Coloured with sustainable dyes. Our water resistant coating is, you guessed it, sustainable. So we think Super Sustainable is about right.

### LIGHTWEIGHT AND NON-SCRATCH

Being lightweight means lower shipping costs and easier handling. And being non-scratch means your fancy French Oak surfaces will never know we've been there.

### ETHICAL PRODUCTION

There's no use in creating products to help reduce waste if we don't look after our environment and our people in doing so. So we make sure that we look after both.

MATTEURS



MATTEURS

COTTON STONE VASE COLLECTION

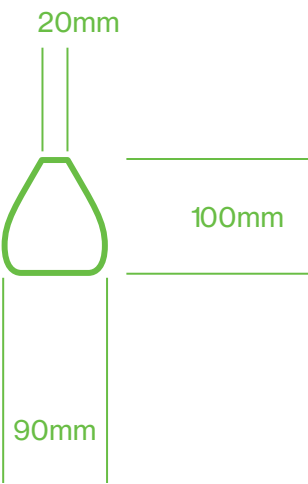
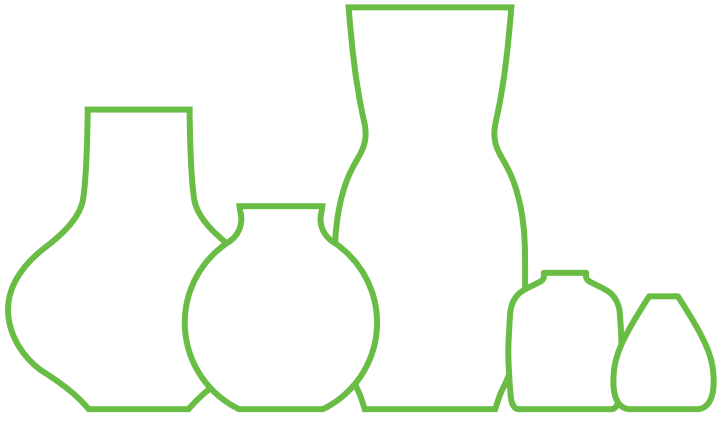

1. TEAR VASE

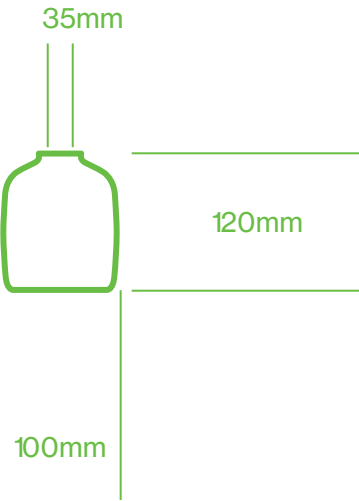

2. JAR VASE

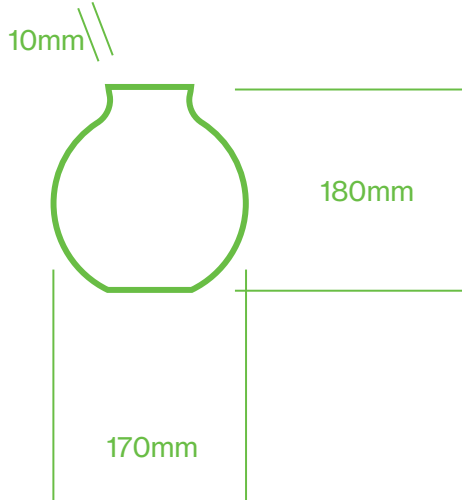

3. ROUND VASE

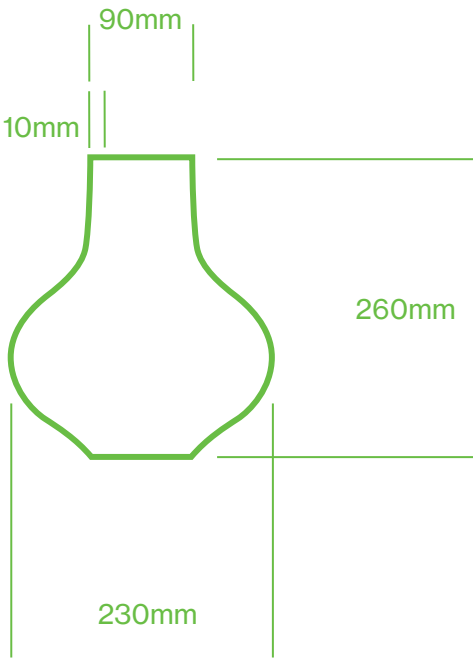

4. GOURD VASE

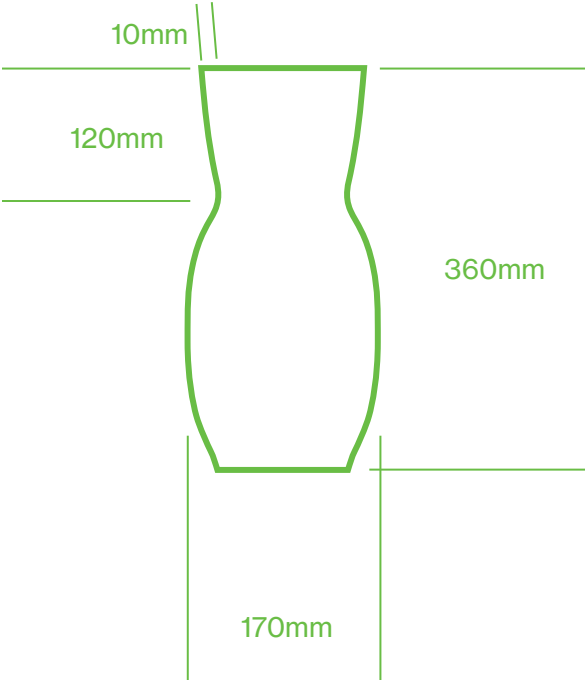

5. STEM VASE

MATTEURS

COTTON STONE VASE COLLECTION

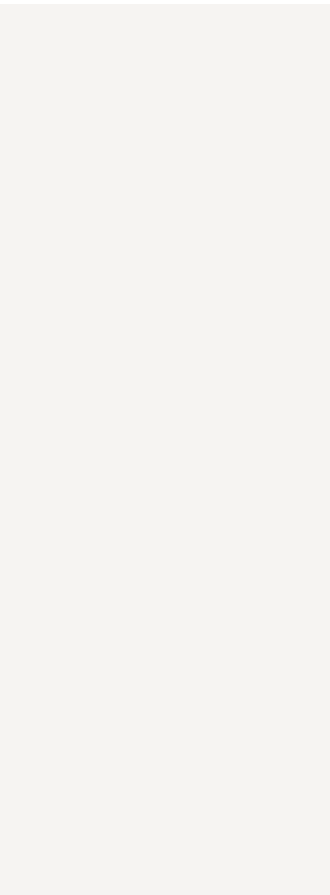
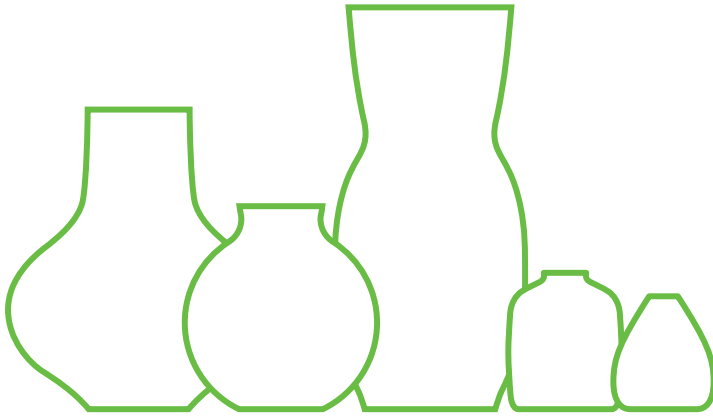

1.  
EGG SHELL

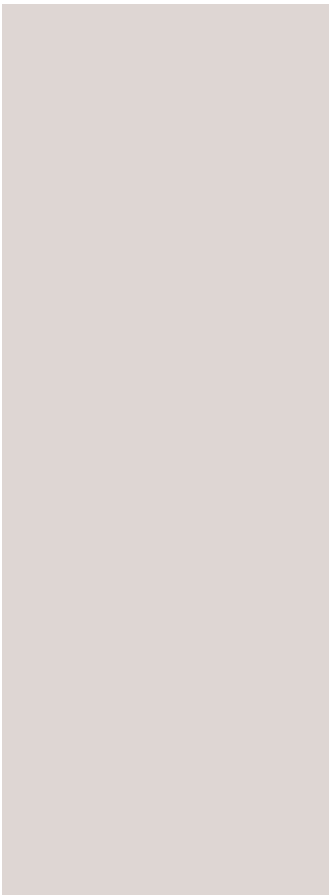

2.  
SOFT BEIGE



3.  
WARM GREY

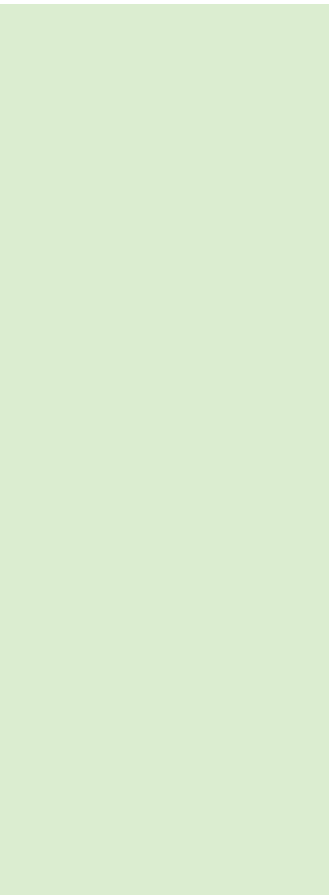



















4.  
LIGHT MINT



5.  
RUST

MOTTEURS

	Tear Vase Leaf Texture	Jar Vase Dash Dash Texture	Round Vase Dash Dash Texture	Round Vase Leaf Texture	Gourd Vase Dash Dash Texture	Stem Vase Dash Dash Texture
Egg Shell	ML-1001 	MDD-2001 	MDD-4001 	ML-4005 	MDD-5001 	MDD-6001 
Soft Beige	ML-1002 	MDD-2002 	MDD-4002 	ML-4006 		MDD-6002 
Light Mint	ML-1003 	MDD-2003 				
Warm Grey			MDD-4003 	ML-4007 	MDD-5002 	
Rust			MDD-4004 	ML-4008 	MDD-5003 	



# MATTEURS

SUSTAINABLE WASTE MADE BEAUTIFUL

[matteurs.com](https://matteurs.com)

[contact@matteurs.com](mailto:contact@matteurs.com)

[wearematteurs](https://www.instagram.com/wearematteurs)

Anders Gabrielsson – 0411 604 594

Matt Gilmour – 0429 343 868

# MATTEURS

SUSTAINABLE WASTE MADE BEAUTIFUL