



19x25W ZOOM LED Moving Head Lighting



Innovation, Quality, Performance

User Manual

Please read the instruction carefully before use

TABLE OF CONTENTS

1. Safety Instructions.....	2
2. Technical Specifications.....	3
3. How To Set The Unit.....	4
3.1 Control panel.....	4
3.2 Main Function.....	5
3.3 Home Position Adjustment	13
4. Control By Universal DMX Controller	13
4.1 DMX 512 Connection.....	13
4.2 Address Setting.....	14
4.3 DMX 512 Configuration	16
5. Troubleshooting	21
6. Fixture Cleaning.....	21

5. Troubleshooting

Following are a few common problems that may occur during operation. Here are some suggestions for easy troubleshooting:

A. The unit does not work, no light and the fan does not work

1. Check the connection of power and main fuse.
2. Measure the mains voltage on the main connector.
3. Check the power on LED.

B. Not responding to DMX controller

1. DMX LED should be on. If not, check DMX connectors and cables to see if link properly.
2. If the DMX LED is on and no response to the channel, check the address settings and DMX polarity.
3. If you have intermittent DMX signal problems, check the pins on connectors or on PCB of the unit or the previous one.
4. Try to use another DMX controller.
5. Check if the DMX cables run near or run alongside to high voltage cables that may cause damage or interference to DMX interface circuit.

C. One of the channels is not working well

1. The stepper motor might be damaged or the cable connected to the PCB is broken.
2. The motor's drive IC on the PCB might be out of condition.

6. Fixture Cleaning

The cleaning must be carried out periodically to optimize light output. Cleaning frequency depends on the environment in which the fixture operates: damp, smoky or particularly dirty surrounding can cause greater accumulation of dirt on the unit's optics.

- Clean with soft cloth using normal glass cleaning fluid.
- Always dry the parts carefully.
- Clean the external optics at least every 30 days.

1. Safety Instructions



WARNING

Please read the instruction carefully which includes important information about the installation, usage and maintenance.

Please keep this User Manual for future consultation. If you sell the unit to another user, be sure that they also receive this instruction booklet.

- Unpack and check carefully there is no transportation damage before using the unit.
- Before operating, ensure that the voltage and frequency of power supply match the power requirements of the unit.
- It's important to ground the yellow/green conductor to earth in order to avoid electric shock.
- The unit is for indoor use only. Use only in a dry location.
- The unit must be installed in a location with adequate ventilation, at least 50cm from adjacent surfaces. Be sure that no ventilation slots are blocked.
- Disconnect main power before replacement or servicing.
- Make sure there are no flammable materials close to the unit while operating as it is fire hazard.
- Use safety cables when fixing this unit. DO NOT handle the unit by its head only, always carry by its base.
- Maximum ambient temperature is Ta: 40 degrees C. DO NOT operate it where the temperature is higher than this.
- Unit surface temperature may reach up to 75 degrees C. DO NOT touch the housing with bare-hands during its operation. Turn off the power and allow about 15 minutes for the unit to cool down before replacing or serving.
- In the event of a serious operating problem, stop using the unit immediately. Never try to repair the unit by yourself. Repairs carried out by unskilled people can lead to damage or malfunction. Please contact the nearest authorized technical assistance center. Always use the same type spare parts.
- DO NOT touch any wire during operation as high voltage may cause electric shock.

Warning:

- To prevent or reduce the risk of electrical shock or fire, do not expose the unit to rain or moisture.
- The housing and lenses must be replaced if they are visibly damaged.

Caution:

There are no user serviceable parts inside the unit. Do not open the housing or attempt any repairs yourself. In the unlikely event your unit may require service, please contact your nearest dealer.

Installation:

The fixture should be mounted via its Omega Quick Release Clamp bracket. Always ensure that the unit is firmly fixed to avoid vibration and slipping while operating and make sure that the structure to which you are attaching the unit is secure and is able to support a weight of 10 times of the fixtures weight. Always use a safety cable that can hold 12 times of the weight of the fixture when installing.

The equipment must be installed by professionals. It must be installed in a place where is out of the reach of people and no one can pass by or under it.

2. Technical Specifications

- ◇ Extremely small, fast and powerful LED moving beam.
- ◇ DMX Channels: 19/36 channels mode
- ◇ Outstanding color macro effect
- ◇ Variable strobe effects
- ◇ Blue white LCD display for easy navigation
- ◇ Perfect for stage, theatre, TV studio, rental and discotheques
- ◇ **Input Voltage:** AC 100 ~ 240V, 50/60Hz
- ◇ **Power Consumption:** 500W

	190-204 205-209 210-224 225-229 230-244 245-255	Strobe 8: random burst pulse, fast →slow Open Strobe 9: sine wave, fast →slow Open Strobe 10: burst, fast →slow Open
10	000-255	RED 1
11	000-255	GREEN 1
12	000-255	BLUE 1
13	000-255	WHITE 1
14	000-255	COLOR 1
15	000-255	RED 2
16	000-255	GREEN 2
17	000-255	BLUE 2
18	000-255	WHITE 2
19	000-255	COLOR 2
20	000-255	RED 3
21	000-255	GREEN 3
22	000-255	BLUE 3
23	000-255	WHITE 3
24	000-255	COLOR 3
25	092-099	RING MARCO
26	100-106	RING MARCO SPEED
27	107-113	COLOR TEMPERATURE
28	114-121	RED
29	122-128	GREEN
30	129-136	BLUE
31	137-143	WHITE
32	144-151	COLOR
33	152-158	COLOR CHANGE SPEED (OPEN 35-CH 020-029)
34	159-165	COLOR FADE SPEED (OPEN 35-CH 030-039)
35	000-009 010-019 020-029 030-039 040-255	COLOR MARCO Ring Control Overall Control Color Change Color Gradient Change Built-in programs
36	000-255	MARCO SPEED (OPEN 35-CH 040-255)

- ◇ **Power Cable Daisy Chain:** 9 Fixture Max. (230V, 50Hz) 5
Fixture Max. (120V, 60Hz)
- ◇ **Control Mode:** DMX512, RDM
- ◇ **LED Source:** 19 × 25W Prolight LED
- ◇ **Beam Angel:** 10° ~ 60°
- ◇ **Weight:** 9.5Kgs
- ◇ **Dimension:** 350 × 200 × 400mm

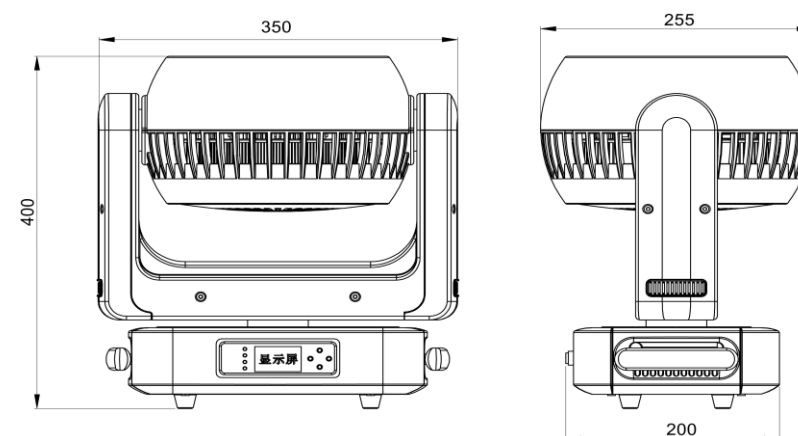

3. How To Set The Unit

3.1 Control panel

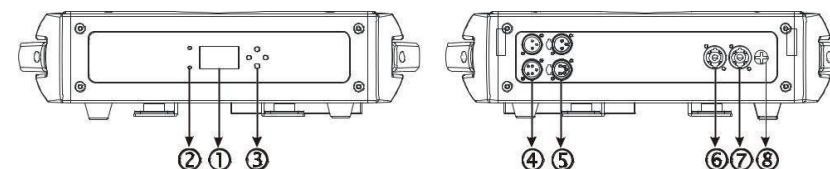

1. Function Display:

Shows the various menus and the selected functions

2. LED:

POWER	ON	Power On
--------------	-----------	----------

DMX	ON	DMX input present
-----	----	-------------------

3. Button:

MENU	To select the programming functions
▼ DOWN	To go backward in the selected functions
▲ UP	To go forward in the selected functions
ENTER	To confirm the selected functions

4. DMX IN:

DMX512 link, use 3/5-pin XLR cable to link the unit and the DMX controller

5. DMX OUT:

DMX512 link, use 3/5-pin XLR cable to link the next unit and output DMX signal

6. MAINS IN:

PowerCon connection from main power supply

7. MAIS OUT:

PowerCon loop connection for main power supply to the next unit

8. Fuse (T 10A):

Protects the unit from over-voltage or short circuit

3.2 Main Function

To select any of the given functions, press the **MENU** button until the required function is showing on the display. Select the function by pressing the **ENTER** button and the display will blink. Use the

DOWN/UP buttons to change the mode. Once the required mode has been selected, press the

ENTER button to setup, to go back to the functions without any change press the **MENU** button again. Press and hold the **MENU** button for about one second or wait for one minute to exit the menu mode.

The main functions are shown overleaf:

36 Channels Mode:

CHANNEL	VALUE	FUNCTION
1	000-255	PAN
2	000-255	PAN FINE
3	000-255	TILT
4	000-255	TILT FINE
5	000-255	PAN/TILT SPEED fast → slow
6	000-255	ZOOM wide → narrow
7	000-009 010-014 015-255	SPECIAL FUNCTIONS No function Reset No function
8	000-255	DIMMER 0%~100%
9	000-019 020-024 025-064 065-069 070-084 085-089 090-104 105-109 110-124 125-129 130-144 145-149 150-164 165-169 170-184 185-189	SHUTTER Blackout Open Strobe 1: fast →slow Open Strobe 2: opening pulse, fast →slow Open Strobe 3: closing pulse, fast →slow Open Strobe 4: random strobe, fast →slow Open Strobe 5: random opening pulse, fast →slow Open Strobe 6: random closing pulse, fast →slow Open Strobe 7: burst pulse, fast →slow Open

12	000-255	BLUE(0%-100%)
13	000-255	WHITE(0%-100%)
14	000-255	COLOR
15	000-255	COLOR CHANGE SPEED (OPEN 17-CH 020-029)
16	000-255	COLOR FADE SPEED (OPEN 17-CH 030-039)
17		COLOR MARCO
	0-19	Overall Control
	20-29	Color Change
	30-39	Color Gradient Change
	40-255	Built-in programs
18	0-255	MARCO SPEED (OPEN 17-CH 040-255)
19	0-255	COLOR TEMPERATURE

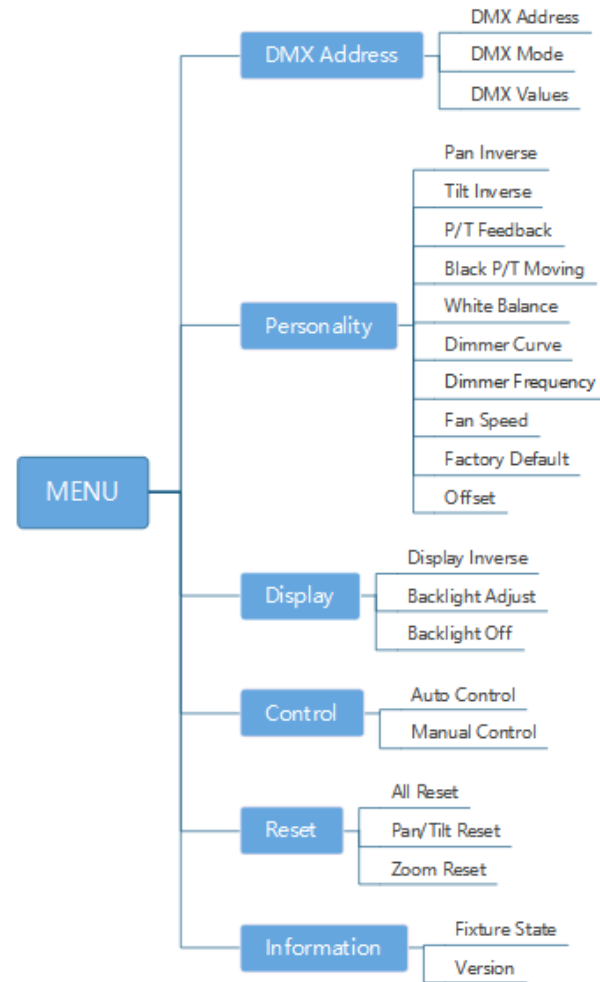

DMX Functions

Enter MENU mode, select **DMX Functions**, press the **ENTER** button to confirm, use the **UP/DOWN** button to select **DMX Address**, **DMX Channel Mode** or **View DMX Value**.

DMX Address

To select **DMX Address**, press the **ENTER** button to show the **DMX ADDRESS** on the display. Use the **UP/DOWN** button to adjust the address from **001** to **512**, press the **ENTER** button to setup. Press the **MENU** button back to the last menu or let the unit idle one minute to exit menu mode.

DMX Channel Mode

To select **DMX Channel Mode**, press the **ENTER** button to show the **DMX CHANNEL MODE** on the display. Use the **UP/DOWN** button to select **Mode1 (14)** or **Mode2 (26)**, and press the **ENTER** button to setup. Press the **MENU** button back to the last menu or let the unit idle one minute to exit menu mode.

View DMX Value

To select **View DMX Value**, press the **ENTER** button to show the **VIEW DMX VALUE** on the display. Use the **UP/DOWN** button to view the DMX channel values. Press the **MENU** button back to the last menu or let the unit idle one minute to exit menu mode.

Fixture Setting

Enter MENU mode, select **Fixture Setting**, press the **ENTER** button to confirm, use the **UP/DOWN** button to select **Pan Inverse**, **Tile Inverse**, **P/T Feedback**, **BL.O. P/T Moving**, **White Balance**, **Cooling Mode**, **Dimmer Curve** or **Dimmer Speed**.

Pan Inverse

To select **Pan Inverse**, press the **ENTER** button to show the **PAN INVERSE** on the display. Use the **UP/DOWN** button to select **No** (normal) or **Yes** (pan inverse), press the **ENTER** button to setup. Press the **MENU** button back to the last menu or let the unit idle one minute to exit menu mode.

Tilt Inverse

To select **Tilt Inverse**, press the **ENTER** button to show the **TILT INVERSE** on the display. Use the **UP/DOWN** button to select **No** (normal) or **Yes** (tilt inverse), press the **ENTER** button to setup. Press the **MENU** button back to the last menu or let the unit idle one minute to exit menu mode.

4.3 DMX 512 Configuration

19 Channels Mode:

CHANNEL	VALUE	FUNCTION
1	000-255	PAN
2	000-255	PAN FINE
3	000-255	TILT
4	000-255	TILT FINE
5	000-255	PAN/TILT SPEED fast → slow
6	000-255	ZOOM wide → narrow
7	000-009 010-014 015-255	SPECIAL FUNCTIONS No function Reset No function
8	000-255	DIMMER 0%~100%
9	000-019 020-024 025-064 065-069 070-084 085-089 090-104 105-109 110-124 125-129 130-144 145-149 150-164 165-169 170-184 185-189 190-204 205-209 210-224 225-229 230-244 245-255	SHUTTER Blackout Open Strobe 1: fast →slow Open Strobe 2: opening pulse, fast →slow Open Strobe 3: closing pulse, fast →slow Open Strobe 4: random strobe, fast →slow Open Strobe 5: random opening pulse, fast →slow Open Strobe 6: random closing pulse, fast →slow Open Strobe 7: burst pulse, fast →slow Open Strobe 8: random burst pulse, fast →slow Open Strobe 9: sine wave, fast →slow Open Strobe 10: burst, fast →slow Open
10	000-255	RED (0% → 100%)
11	000-255	GREEN (0% → 100%)

Please refer to the following diagram to set the DMX address for the first 4 units:

Channel mode	Unit 1 Address	Unit 2 Address	Unit 3 Address	Unit 4 Address
19 channels	1	20	39	58
36 channels	1	37	73	109

P/T Feedback

To select **P/T Feedback**, press the **ENTER** button to show the **PAN/TILT FEEDBACK** on the display. Use the **UP/DOWN** button to select **No** (Pan or tilt's position will not feedback while out of step) or **Yes** (Feedback while pan/tilt out of step), press the **ENTER** button to setup. Press the **MENU** button back to the last menu or let the unit idle one minute to exit menu mode.

BL.O. P/T Moving

To select **BL.O. P/T Moving**, press the **ENTER** button to show the **BLACKOUT WHILE PAN/TILT MOVING** on the display, use the **UP/DOWN** button to select **No** (normal while pan/tilt moving) or **Yes** (blackout while pan/tilt moving), press the **ENTER** button to setup. Press the **MENU** button back to the last menu or let the unit idle one minute to exit menu mode.

White Balance

To select **White Balance**, press the **ENTER** button to show the **WHITE BALANCE** on the display, use the **UP/DOWN** button to select **Red**, **Green** or **Blue**. Once selected, press the **ENTER** button to confirm, and use the **UP/DOWN** button to adjust the value from **125** to **255**, press the **ENTER** button to setup. Press the **MENU** button back to the last menu or let the unit idle one minute to exit menu mode.

Cooling Mode

To select **Cooling Mode**, press the **ENTER** button to show the **COOLING MODE** on the display. Use the **UP/DOWN** button to select **Auto** (Normal) or **Low** (Low speed). Once selected, press the **ENTER** button to setup. Press the **MENU** button back to the last menu or let the unit idle one minute to exit menu mode.

Dimmer Curve

To select **Dimmer Curve**, press the **ENTER** button to show the **DIMMER CURVE** on the display, use the **UP/DOWN** button to select **Linear**, **Square Law**, **Inverse Squ.** or **S-curve**. Once selected, press the **ENTER** button to store. Press the **MENU** button back to the last menu or let the unit idle one minute to exit menu mode.

Dimmer Modes:

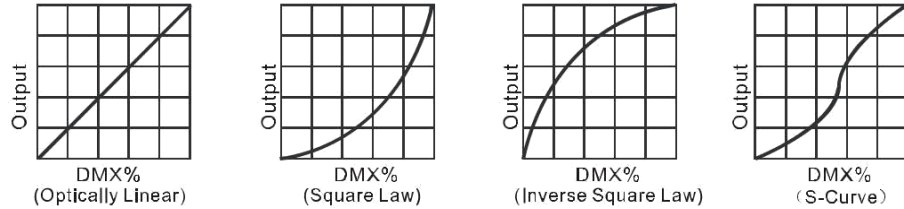

Linear: The increase in light intensity appears to be linear as DMX value is increased.

Square Law: Light intensity control is finer at low levels and coarser at high levels.

Inverse Square Law: Light intensity control is coarser at low levels and finer at high levels.

S-cure: Light intensity control is finer at low levels and high levels and coarser at medium levels.

Dimmer Speed

To select **Dimmer Speed**, press the **ENTER** button to show the **DIMMER SPEED** on the display. Use the **UP/DOWN** button to select **Fast** or **Smooth**. Once selected, press the **ENTER** button to setup. Press the **MENU** button back to the last menu or let the unit idle one minute to exit menu mode.

Display Setting

Enter **MENU** mode, select **Display Setting**, press the **ENTER** button to confirm, use the **UP/DOWN** button to select **Display Inverse**, **Backlight Auto Off**, **Backlight Intensity**, **Temperature unit** or

Display Warning.

Display Inverse

To select **Display Inverse**, press the **ENTER** button to show the **DISPLAY INVERSE** on the display. Use the **UP/DOWN** button to select **No** (normal) or **Yes** (display inverse). Once selected, press the **ENTER** button to store. Press the **MENU** button back to the last menu or let the unit idle one minute to exit menu mode.

Backlight Auto Off

To select **Backlight Auto Off**, press the **ENTER** button to show the **BACKLIGHT AUTO OFF** on the display. Use the **UP/DOWN** button to select **No** (display always on) or **Yes** (display goes off one minute after exiting menu mode). Once selected, press the **ENTER** button to confirm and store. Press the **MENU** button back to the last menu or let the unit idle one minute to exit menu mode.

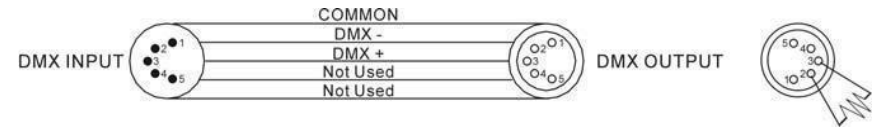

1. If you using a controller with 5 pins DMX output, you need to use a 5 to 3 pin adapter-cable.
2. The last units DMX cable has to be terminated with a 120 ohm 1/4W resistor between pin 2(DMX-) and pin 3(DMX+) of a 3-pin XLR-plug and plug it in the DMX-output of the last unit.
3. Connect the unit together in a `daisy chain` by XLR plug from the output of the unit to the input of the next unit. The cable can not branched or split to a `Y` cable. DMX 512 is a very high-speed signal. Inadequate or damaged cables, soldered joints or corroded connectors can easily distort the signal and shut down the system.
4. The DMX output and input connectors are pass-through to maintain the DMX circuit, when one of the units' power is disconnected.
5. Each fixture unit needs to have an address set to receive the data sent by the controller. The address number is between 0-511 (usually 0 & 1 are equal to 1).
6. The end of the DMX 512 system should be terminated to reduce signal errors.
7. 3 pin XLR connectors are more popular than 5 pin XLR.
 - 3 pin XLR: Pin 1: GND, Pin 2: Negative signal (-), Pin 3: Positive signal (+)
 - 5 pin XLR: Pin 1: GND, Pin 2: Negative signal (-), Pin 3: Positive signal (+), Pin 4/Pin 5: Not used.

4.2 Address Setting

If you use a universal DMX controller to control the units, you have to set DMX address from 1 to 512 so that the units can receive DMX signal.

Press the **MENU** button to enter menu mode, select **DMX Functions**, press the **ENTER** button to confirm, use the **UP/DOWN** button to select **DMX Address**, press the **ENTER** button to confirm, the present address will blink on the display, use the **UP/DOWN** button to adjust the address from 001 to 512, and press the **ENTER** button to store. Press the **MENU** button back to the last menu or let the unit idle 7 seconds to exit menu mode.

3.3 Home Position Adjustment

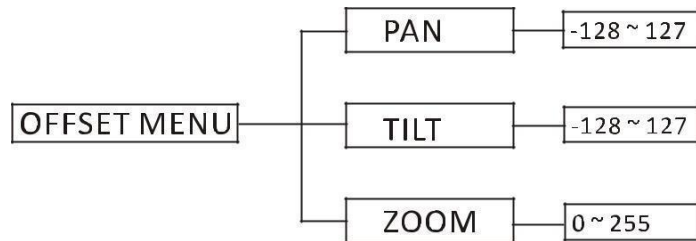

In the main functions, hold the **ENTER** button for at least 3 seconds into offset mode, use the **DOWN/UP** button up to select **Pan** Offset, **Tilt** Offset or **Zoom** Offset, and press the **ENTER** button to confirm. Use the **DOWN/UP** button to adjust the home position of the Pan, Tilt or Zoom, Once the position has been selected, press the **ENTER** button to setup, to go back to the functions without any change press the **MENU** button again. Press and hold the **MENU** button about one second or wait for about one minute to exit the menu mode.

4. Control By Universal DMX Controller

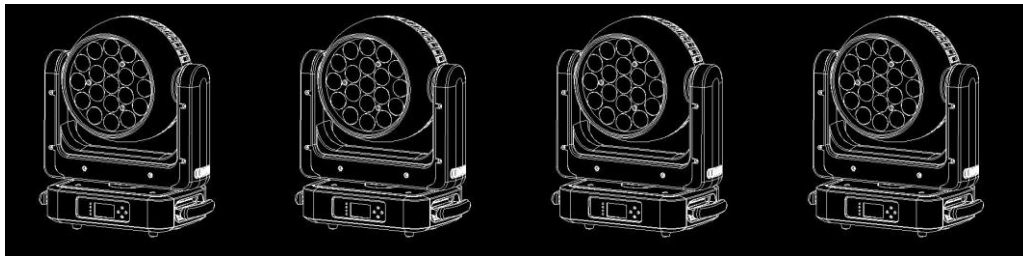

Backlight Intensity

To select **Backlight Intensity**, press the **ENTER** button to show the **BACKLIGHT INTENSITY** on the display. Use the **UP/DOWN** button to adjust the intensity from **1** (dark) to **10** (bright). Once selected, press the **ENTER** button to setup and store. Press the **MENU** button back to the last menu or let the unit idle one minute to exit menu mode.

Temperature Unit

To Select **Temperature Unit**, press the **ENTER** button to show the **TEMPERATURE UNIT** on the display. Use the **UP/DOWN** button to select **°C** or **°F**, press the **ENTER** button to store. Press the **MENU** button back to the last menu or let the unit idle one minute to exit menu mode.

Display Warning

To select **Display Warning**, press the **ENTER** button to show the **DISPLAY WARNING** on the display. Use the **UP/DOWN** button to select **No** (Normal) or **Yes** (display will show the error warning when the unit went wrong), press the **ENTER** button to store. Press the **MENU** button back to the last menu or let the unit idle one minute to exit menu mode.

Fixture Test

Enter **MENU** mode, select **Fixture Test**, press the **ENTER** button to confirm, use the **UP/DOWN** button to select **Auto Test** or **Manual Test**

Auto Test

To select **Auto Test**, press the **ENTER** button to show the **AUTO TEST** on the display. Press the **ENTER** button, the unit will run built-in programs to automatically test pan, tilt and zoom. Press the **MENU** button back to the last menu or exit menu mode after auto test.

Manual Test

To select **Manual Test**, press the **ENTER** button to show the **MANUAL TEST** on the display. Press the **ENTER** button, and then use the **UP/DOWN** button to select channel, and adjust the channel value. Once selected, press the **ENTER** button to setup, the fixture will run as the channel value indicates. Press the **MENU** button back to the last menu or exit menu mode let the unit idle one minute.

(All channels value will become 0 after exiting **Manual Test** menu)

Fixture Information

Enter MENU mode, select **Fixture Information**, press the ENTER button to confirm, use the UP/DOWN button to select **Fixture use time**, **Lamp On time** or **Firmware Version**.

Fixture use time

To select **Fixture use time**, press the ENTER button to show the **FIXTURE USE TIME** on the display. Press the ENTER button, the fixture working hours will show on the display. Press the **MENU** button to exit.

Lamp On time

To select **Lamp On time**, press the ENTER button to show the **LAMP ON TIME** on the display. Press the ENTER button to confirm, then use the UP/DOWN button to select **Exit** or **Reset Time**, press the ENTER button to store. Press the **MENU** button back to the last menu or exit menu mode let the unit idle one minute.

Firmware Version

To select **Firmware Version**, press the ENTER button to show the **FIRMWARE VERSION** on the display. Press the ENTER button and the fixture software version will show on the display. Press the **MENU** button to exit.

Reset Functions

Enter MENU mode, select **Reset Function**, press the ENTER button to confirm, use the UP/DOWN button to select **Pan/Tilt**, **Zoom** or **All**.

Pan/Tilt

To Select **Pan/Tilt**, press the ENTER button to show the **PAN/TILT** on the display. Use the UP/DOWN button to select **Yes** (the unit will run built-in program to reset pan and tilt to their home positions) or **No**, press the ENTER button to store. Press the **MENU** button to exit menu mode.

Zoom

To select **Zoom**, press the ENTER button to show the **ZOOM** on the display. Use the UP/DOWN button to select **Yes** (the unit will run built-in program to reset zoom to its home positions) or **No**, press the ENTER button to store. Press the **MENU** button to exit menu mode.

All

To select **All**, press the ENTER button to show the **ALL** on the display. Use the UP/DOWN button to select **Yes** (the unit will run built-in program to reset all motors to their home positions) or **No**, press ENTER button to store. Press **MENU** button to exit menu mode.

Special Functions

Enter MENU mode, select **Special Functions**, press the ENTER button to confirm, use the UP/DOWN button to select **Fixture Maintenance** or **Factory Setting**.

Fixture Maintenance

To select **Fixture Maintenance**, press the ENTER button to show the **FIXTURE MAINTENANCE** on the display. Use the UP/DOWN button to select **Interval** or **Remain Time**.

Interval

To select **Interval**, press the ENTER button to confirm, the interval time will be shown on the display. Press the **MENU** button to exit.

Remain Time

To select **Remain Time**, press the ENTER button to confirm, the remaining time will be shown on the display. Press the ENTER button to confirm, use the UP/DOWN button to select **Exit** or **Reset time**, press the **MENU** button to exit.

Factory Setting

To select **Factory Setting**, press the ENTER button to show the **FACTORY SETTING** on the display. Press the ENTER button to confirm, use the UP/DOWN button to select **No** or **Yes** (the fixture will reset to factory settings and exit menu mode).