



Master Trac Floor Mount System Parts and Installation



Call us at **1-855-854-7465**

or visit us at

www.woodtrac.com

NOTE: THIS INSTRUCTION BOOKLET CONTAINS
IMPORTANT SAFETY INFORMATION.

PLEASE READ AND KEEP FOR FUTURE REFERENCE.



Made in USA
with U.S. and imported materials

Lot #: 579554

03 /21 / 22

Purchased: _____

Table of Contents

Part Identification	3-9
Hardware Identification	10-12
Hardware Usage Guide	13
Floor Mount Installation	14-34
Door Installation	35
Drawer Installation	36-37
Shoe Shelf Installation	38
Closet Rod Installation	39
Adjustable Shelf Installation	40
H-Joint Channel Installation	41
Cleat Dowel Boring Jig Installation	42
Hole Boring and Jig Installation	43
Cam and Toe Kick Kit	44
Toe Kick Installation	45
Weight Limits	46
Safety	47
Warranty	47

Part Identification

87" Left End Upright

432136 White
430794 Slate Rift
432743 Spice Mahogany

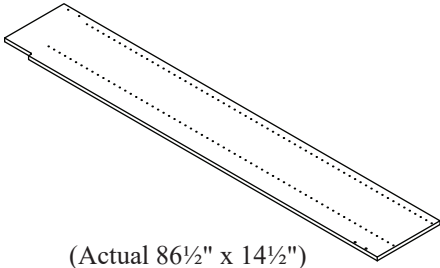

(Actual 86½" x 14½")

87" Center Upright

432519 White
430801 Slate Rift
432749 Spice Mahogany

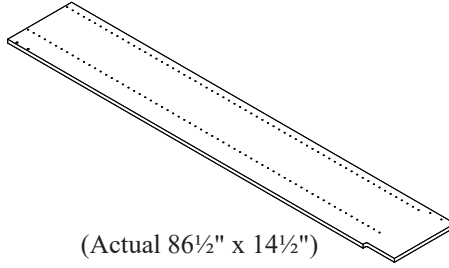

(Actual 86½" x 14½")

87" Right End Upright

432525 White
430807 Slate Rift
432755 Spice Mahogany

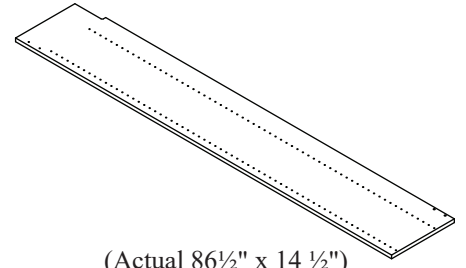

(Actual 86½" x 14 ½")

96" Left End Upright

432514 White
430795 Slate Rift
432744 Spice Mahogany

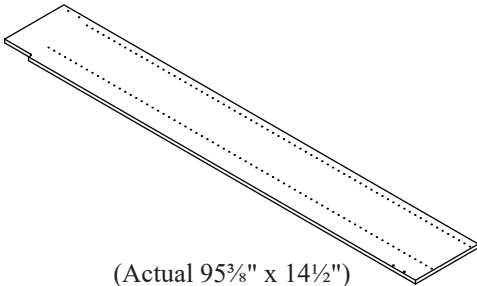

(Actual 95¾" x 14½")

96" Center Upright

432520 White
430802 Slate Rift
432750 Spice Mahogany

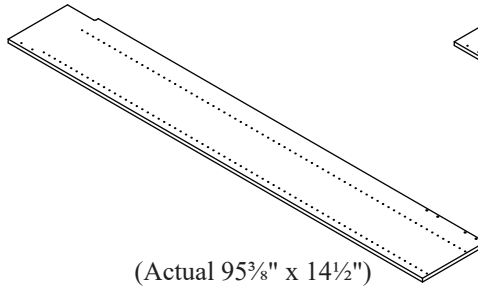

(Actual 95¾" x 14½")

96" Right End Upright

432526 White
430808 Slate Rift
432756 Spice Mahogany

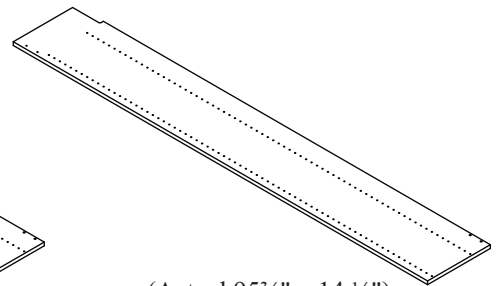

(Actual 95¾" x 14 ½")

14½" x 96" Utility Shelf

432614 White
432037 Slate Rift
432844 Spice Mahogany

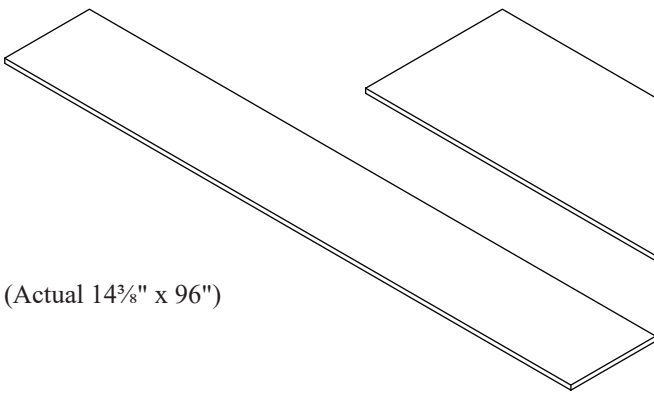

(Actual 14¾" x 96")

24" x 96" Utility Shelf

432615 White
432038 Slate Rift
432845 Spice Mahogany

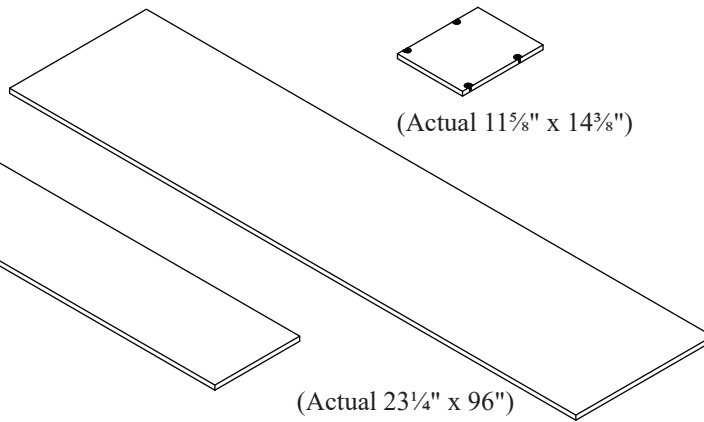

(Actual 23¼" x 96")

12" Fixed Shelf

432527 White
431988 Slate Rift
432757 Spice Mahogany

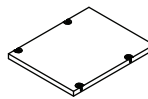

(Actual 11⅝" x 14¾")

18" Fixed Shelf

432528 White
430819 Slate Rift
432758 Spice Mahogany

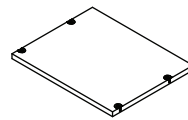

(Actual 18" x 14¾")

24" Fixed Shelf

432529 White
430820 Slate Rift
432759 Spice Mahogany

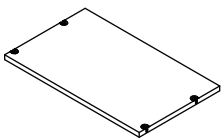

(Actual 24 x 14¾")

30" Fixed Shelf

432530 White
430821 Slate Rift
432760 Spice Mahogany

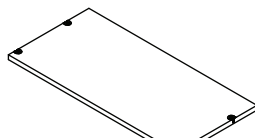

(Actual 30 x 14¾")

36" Fixed Shelf

432531 White
430822 Slate Rift
432761 Spice Mahogany

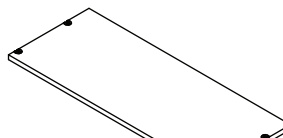

(Actual 36 x 14¾")

42" Fixed Shelf

432532 White
430823 Slate Rift
432762 Spice Mahogany

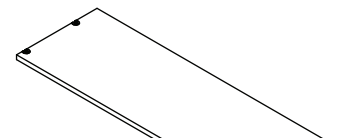

(Actual 42 x 14¾")

Part Identification

12" Cleat
432606 White
431992 Slate Rift
432836 Spice Mahogany

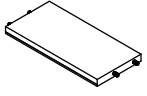

(Actual 5½" x 11⅝")

18" Cleat
432607 White
430860 Slate Rift
432837 Spice Mahogany

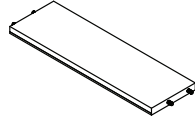

(Actual 5½" x 18")

24" Cleat
432608 White
431613 Slate Rift
432838 Spice Mahogany

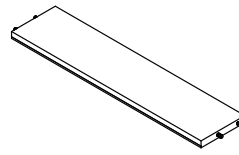

(Actual 5½" x 24")

30" Cleat
432609 White
430816 Slate Rift
432839 Spice Mahogany

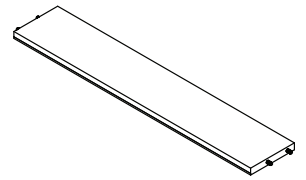

(Actual 5½" x 30")

36" Cleat
432610 White
430817 Slate Rift
432840 Spice Mahogany

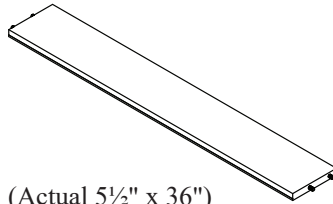

(Actual 5½" x 36")

42" Cleat
432611 White
430818 Slate Rift
432841 Spice Mahogany

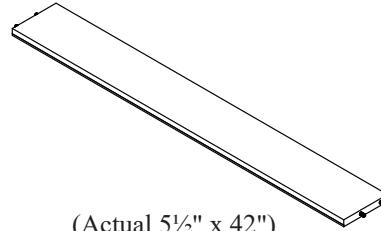

(Actual 5½" x 42")

12" Adjustable Shelf
432533 White
431989 Slate Rift
432763 Spice Mahogany

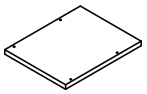

(Actual 11⅝" x 14⅜")

18" Adjustable Shelf
432534 White
430828 Slate Rift
432764 Spice Mahogany

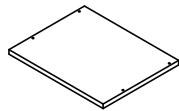

(Actual 18" x 14⅜")

24" Adjustable Shelf
432535 White
430829 Slate Rift
432765 Spice Mahogany

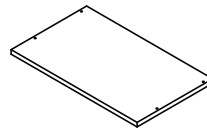

(Actual 24" x 14⅜")

30" Adjustable Shelf
432536 White
430830 Slate Rift
432766 Spice Mahogany

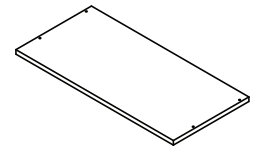

(Actual 30" x 14⅜")

36" Adjustable Shelf
432537 White
430831 Slate Rift
432767 Spice Mahogany

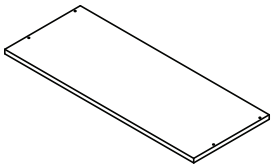

(Actual 36" x 14⅜")

42" Adjustable Shelf
432538 White
430832 Slate Rift
432768 Spice Mahogany

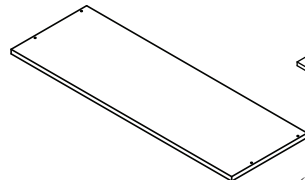

(Actual 42" x 14⅜")

36" x 24" Left End Upright
432539 White
430809 Slate Rift
432769 Spice Mahogany

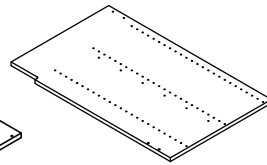

(Actual 37½" x 23¼")

36" x 24" Upright Center
432541 White
430811 Slate Rift
432771 Spice Mahogany

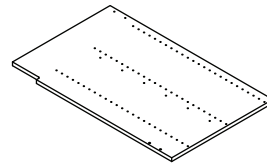

(Actual 37½" x 23¼")

36" x 24" Right End Upright
432543 White
430813 Slate Rift
432773 Spice Mahogany

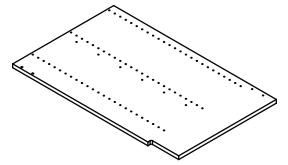

(Actual 37½" x 23¼")

87" x 24" Left End Upright
432540 White
430810 Slate Rift
432770 Spice Mahogany

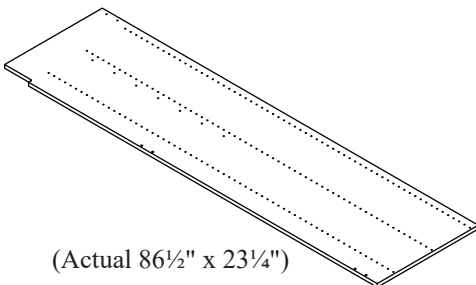

(Actual 86½" x 23¼")

87" x 24" Upright Center
432542 White
430812 Slate Rift
432772 Spice Mahogany

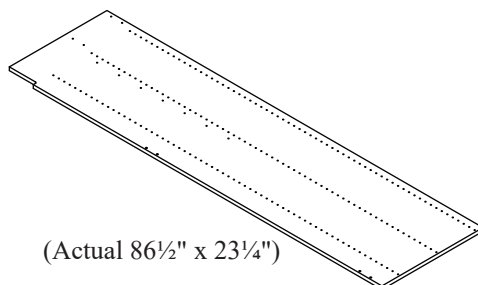

(Actual 86½" x 23¼")

87" x 24" Right End Upright
432544 White
430814 Slate Rift
432774 Spice Mahogany

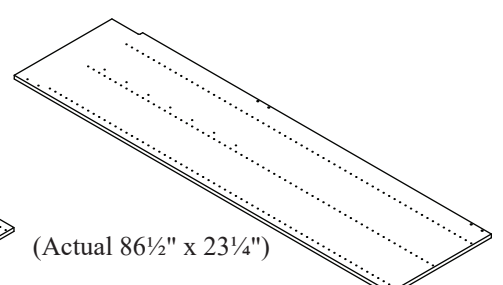

(Actual 86½" x 23¼")

Parts Identification

24" x 24" Fixed Shelf

432545 White
431889 Slate Rift
432775 Spice Mahogany

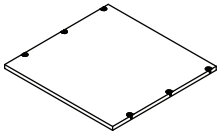

(Actual 24" x 23¹/₄")

30" x 24" Fixed Shelf

432546 White
431891 Slate Rift
432776 Spice Mahogany

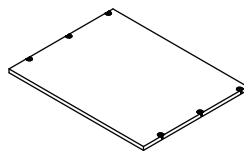

(Actual 30" x 23¹/₄")

24" x 24" Adjustable Shelf

432547 White
431890 Slate Rift
432777 Spice Mahogany

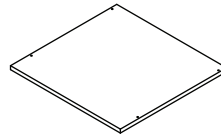

(Actual 24" x 23¹/₄")

30" x 24" Adjustable Shelf

432548 White
431892 Slate Rift
432778 Spice Mahogany

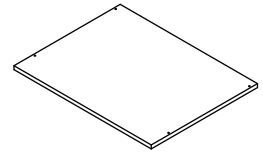

(Actual 30" x 23¹/₄")

87" Hutch Right End

432549 White
430815 Slate Rift
432779 Spice Mahogany

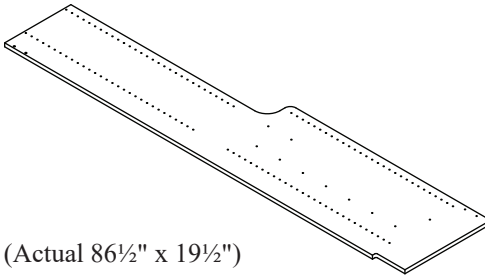

(Actual 86¹/₂" x 19¹/₂")

87" Hutch Left End

432550 White
430835 Slate Rift
432780 Spice Mahogany

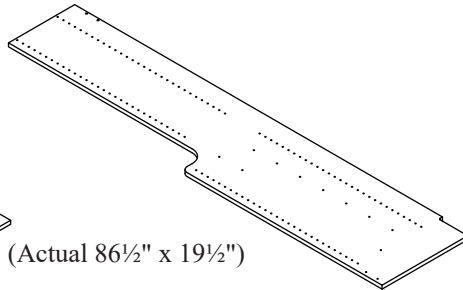

(Actual 86¹/₂" x 19¹/₂")

87" Hutch Center Upright

432551 White
430869 Slate Rift
432781 Spice Mahogany

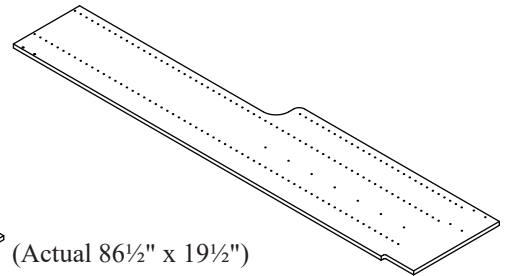

(Actual 86¹/₂" x 19¹/₂")

24" Hutch Fixed Shelf

432552 White
431659 Slate Rift
432782 Spice Mahogany

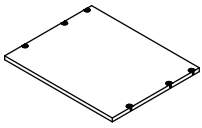

(Actual 24" x 19³/₈")

30" Hutch Fixed Shelf

432553 White
431660 Slate Rift
432783 Spice Mahogany

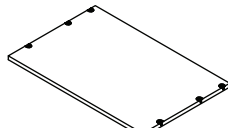

(Actual 30" x 19³/₈")

24" Hutch Adjustable Shelf

432554 White
431661 Slate Rift
432784 Spice Mahogany

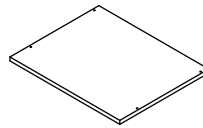

(Actual 24" x 19³/₈")

30" Hutch Adjustable Shelf

432555 White
431662 Slate Rift
432785 Spice Mahogany

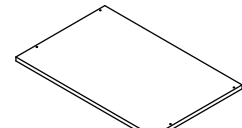

(Actual 30" x 19³/₈")

Fixed Corner Shelf

432556 White
430833 Slate Rift
432786 Spice Mahogany

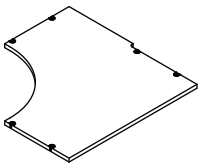

(Actual 29¹/₄" x 29¹/₄")

Adjustable Corner Shelf

432557 White
430834 Slate Rift
432787 Spice Mahogany

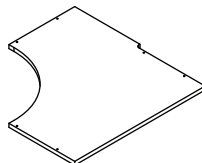

(Actual 29¹/₄" x 29¹/₄")

18" Shoe Shelf

432558 White
430870 Slate Rift
432788 Spice Mahogany

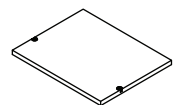

(Actual 18" x 14³/₈")

24" Shoe Shelf (1)

432559 White
430871 Slate Rift
432789 Spice Mahogany

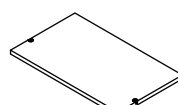

(Actual 24" x 14³/₈")

30" Shoe Shelf

432560 White
430872 Slate Rift
432790 Spice Mahogany

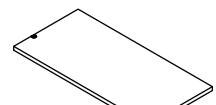

(Actual 30" x 14³/₈")

Part Identification

18" Shoe Fence
432926 Matt Nickel
432925 Polished Chrome

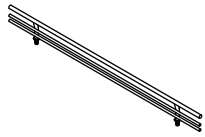

24" Shoe Fence
432927 Matt Nickel
432928 Polished Chrome

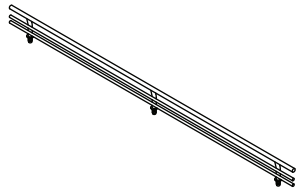

30" Shoe Fence Matt
432929 Matt Nickel
432930 Chrome

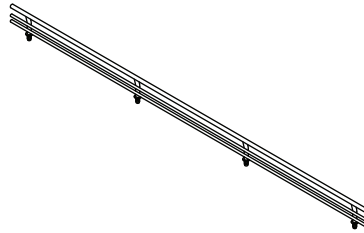

24" Coat Hook Board
432613 White
432035 Slate Rift
432843 Spice Mahogany

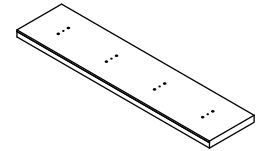

(Actual 5½" x 23⅞")

18" Coat Hook Board
432612 White
432034 Slate Rift
432842 Spice Mahogany

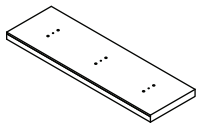

(Actual 5½" x 17⅞")

12" Toe Kick
432561 White
431990 Slate Rift
432791 Spice Mahogany



(Actual 11⅝" x 6¼")

18" Toe Kick
432562 White
430836 Slate Rift
432792 Spice Mahogany

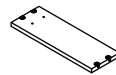

(Actual 18" x 6¼")

24" Toe Kick (1)
432563 White
430837 Slate Rift
432793 Spice Mahogany

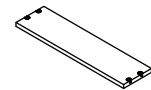

(Actual 24" x 6¼")

30" Toe Kick
432564 White
430838 Slate Rift
432794 Spice Mahogany

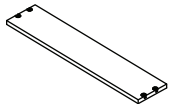

(Actual 30" x 6¼")

36" Toe Kick
432565 White
430839 Slate Rift
432795 Spice Mahogany

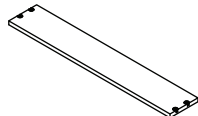

(Actual 36" x 6¼")

42" Toe Kick
432566 White
430840 Slate Rift
432796 Spice Mahogany

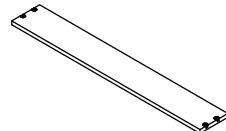

(Actual 42" x 6¼")

Short Corner Toe Kick
433571 White
433573 Slate Rift
433575 Spice Mahogany

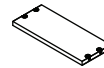

(Actual 15" x 6¼")

Long Corner Toe Kick
433570 White
433572 Slate Rift
433574 Spice Mahogany

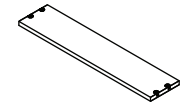

(Actual 28.5" x 6¼")

18" Small Drawer Front
432567 White
430847 Slate Rift
432797 Spice Mahogany

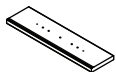

(Actual 18½" x 4⅞")

24" Small Drawer Front
432568 White
430848 Slate Rift
432798 Spice Mahogany

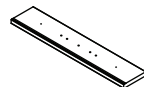

(Actual 24⅝" x 4⅞")

30" Small Drawer Front
432569 White
430849 Slate Rift
432799 Spice Mahogany

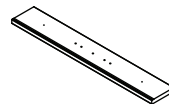

(Actual 30½" x 4⅞")

18" Large Drawer Front Slab
432570 White
430853 Slate Rift
432800 Spice Mahogany

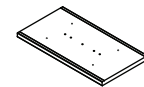

(Actual 18½" x 9⅞")

24" Large Drawer Front Slab (1)
432571 White
430854 Slate Rift
432801 Spice Mahogany

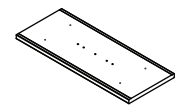

(Actual 24⅝" x 9⅞")

30" Large Drawer Front Slab (1)
432572 White
430855 Slate Rift
432802 Spice Mahogany

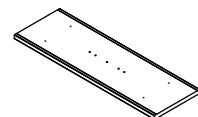

(Actual 30½" x 9⅞")

18" Large Drawer Front Shaker
432573 White
430856 Slate Rift
432803 Spice Mahogany

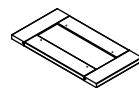

(Actual 18½" x 9⅞")

24" Large Drawer Front Shaker
432574 White
430857 Slate Rift
432804 Spice Mahogany

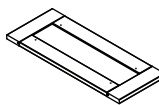

(Actual 24⅝" x 9⅞")

30" Large Drawer Front Shaker
432575 White
430858 Slate Rift
432805 Spice Mahogany

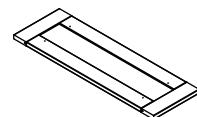

(Actual 30½" x 9⅞")

Parts Identification

24" x 30" Slab Door

- 432731 White Kit
- 432730 White Doors only (2)
- 432617 Slate Rift Kit
- 432616 Slate Rift Doors only (2)
- 432847 SP Mahog Kit
- 432846 SP Mahog Doors only (2)
- 432396 Hardware

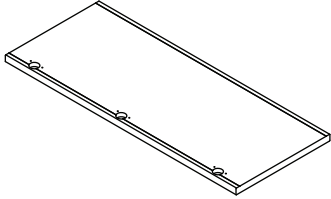

(Actual 12¼" x 30⅞" each)

24" x 44" Slab Door

- 432576 White Kit
- 432577 White Doors only (2)
- 432398 Slate Rift Kit
- 430859 Slate Rift Door only (2)
- 432806 SP Mahog Kit
- 432807 SP Mahog Doors only (2)
- 432396 Hardware

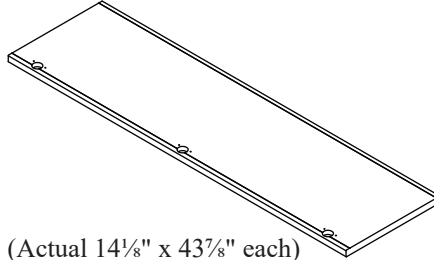

(Actual 14⅞" x 43⅞" each)

24" x 52" Slab Door

- 432580 White Kit
- 432581 White Doors only (2)
- 432400 Slate Rift Kit
- 430850 Slate Rift Doors only (2)
- 432810 SP Mahog Kit
- 432811 SP Mahog Doors only (2)
- 432396 Hardware

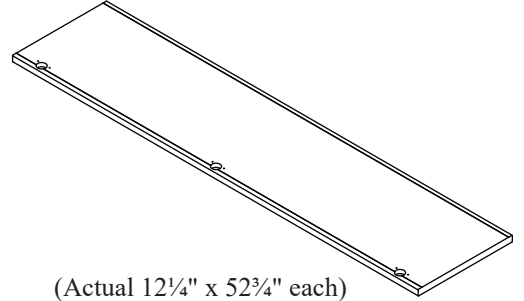

(Actual 12¼" x 52¾" each)

24" x 80" Slab Door

- 432592 White Kit
- 432593 White Doors only (2)
- 432406 Slate Rift Kit
- 430863 Slate Rift Doors only (2)
- 432822 SP Mahog Kit
- 432823 SP Mahog Doors only (2)
- 432397 Hardware

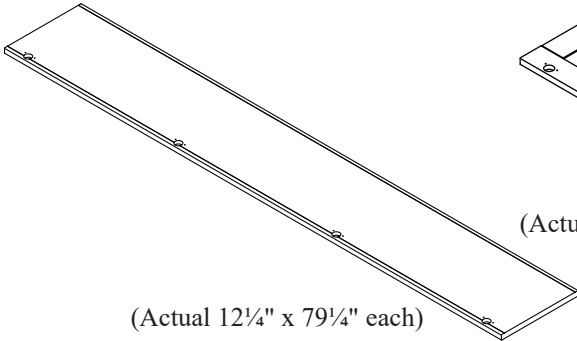

(Actual 12¼" x 79¼" each)

24" x 30" Shaker Door Assembly

- 432733 White Kit
- 432732 White Doors only (2)
- 432619 Slate Rift Kit
- 432618 Slate Rift Doors only (2)
- 432849 SP Mahog Kit
- 432848 SP Mahog Doors only (2)
- 432396 Hardware

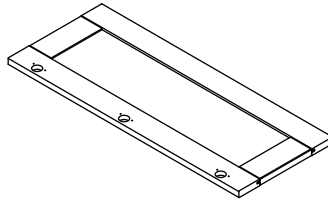

(Actual 12¼" x 30⅞" each)

24" x 44" Shaker Door Assembly

- 432578 White Kit
- 432579 White Doors only (2)
- 432399 Slate Rift Kit
- 430861 Slate Rift Doors only (2)
- 432808 SP Mahog Kit
- 432809 SP Mahog Doors only (2)
- 432396 Hardware

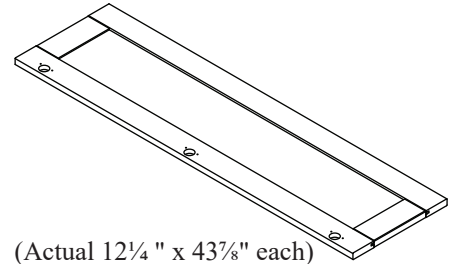

(Actual 12¼" x 43⅞" each)

24" x 52" Shaker Door Assembly

- 432582 White Kit
- 432583 White Doors only (2)
- 432401 Slate Rift Kit
- 430851 Slate Rift Doors only (2)
- 432812 SP Mahog Kit
- 432813 SP Mahog Doors only (2)
- 432396 Hardware

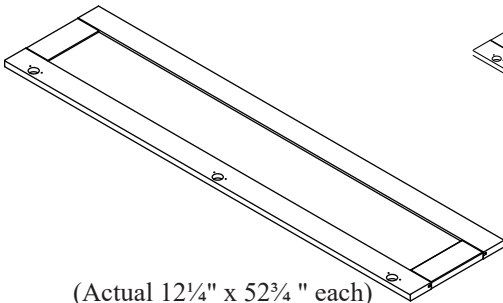

(Actual 12¼" x 52¾" each)

24" x 80" Shaker Door Assembly

- 432594 White Kit
- 432595 White Doors only (2)
- 432407 Slate Rift Kit
- 430864 Slate Rift Doors only (2)
- 432824 SP Mahog Kit
- 432825 SP Mahog Doors only (2)
- 432397 Hardware

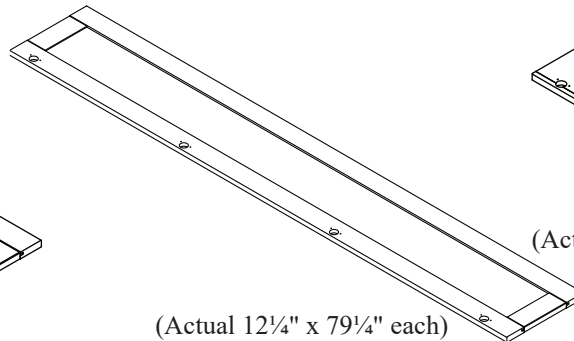

(Actual 12¼" x 79¼" each)

30" x 30" Slab Door

- 432735 White Kit
- 432734 White Doors only (2)
- 432621 Slate Rift Kit
- 432620 Slate Rift Doors only (2)
- 432851 SP Mahog Kit
- 432850 SP Mahog Doors only (2)
- 432396 Hardware

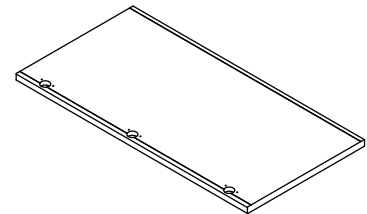

(Actual 15¼" x 30⅞" each)

Part Identification

30" x 44" Slab Door

432584 White Kit
 432585 White Doors only (2)
 432402 Slate Rift Kit
 431883 Slate Rift Doors only (2)
 432814 SP Mahog Kit
 432815 SP Mahog Doors only (2)
 432396 Hardware

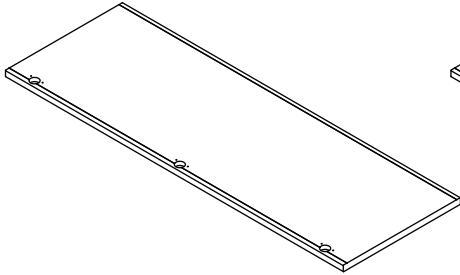

(Actual 15 1/4" x 43 7/8" each)

30" x 52" Slab Door

432588 White Kit
 432589 White Doors only (2)
 432404 Slate Rift Kit
 431885 Slate Rift Doors only (2)
 432818 SP Mahog Kit
 432819 SP Mahog Doors only (2)
 432396 Hardware

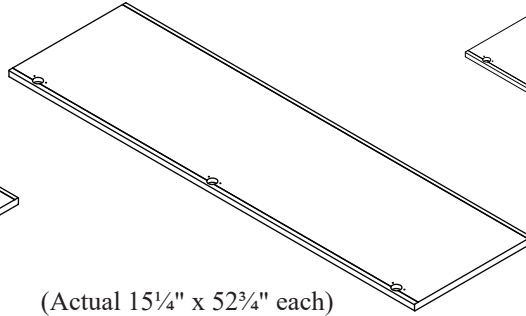

(Actual 15 1/4" x 52 3/4" each)

30" x 80" Slab Door

432596 White Kit
 432597 White Doors only (2)
 432408 Slate Rift Kit
 431887 Slate Rift Doors only (2)
 432826 SP Mahog Kit
 432827 SP Mahog Doors only (2)
 432397 Hardware

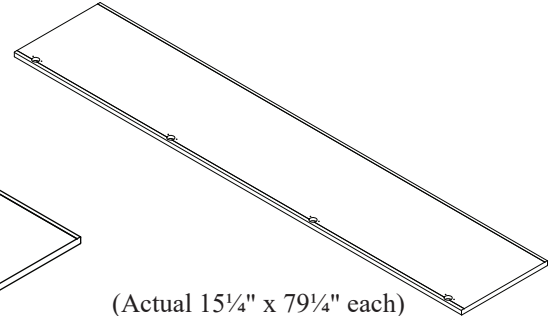

(Actual 15 1/4" x 79 1/4" each)

30" x 30" Shaker Door Assembly

432737 White Kit
 432736 White Doors only (2)
 432623 Slate Rift Kit
 432622 Slate Rift Doors only (2)
 432853 SP Mahog Kit
 432852 SP Mahog Doors only (2)
 432396 Hardware

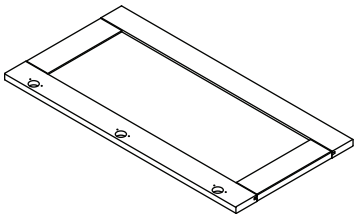

(Actual 15 1/4" x 30 1/8" each)

30" x 44" Shaker Door Assembly

432586 White Kit
 432587 White Doors only (2)
 432403 Slate Rift Kit
 431884 Slate Rift Doors only (2)
 432816 SP Mahog Kit
 432817 SP Mahog Doors only (2)
 432396 Hardware

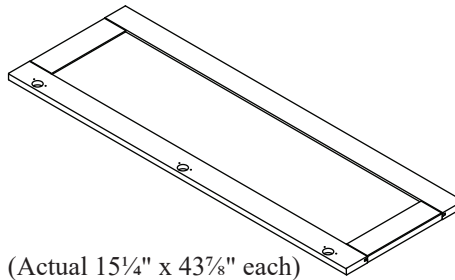

(Actual 15 1/4" x 43 7/8" each)

30" x 52" Shaker Door Assembly

432590 White Kit
 432591 White Doors only (2)
 432405 Slate Rift Kit
 431886 Slate Rift Doors only (2)
 432820 SP Mahog Kit
 432821 SP Mahog Doors only (2)
 432396 Hardware

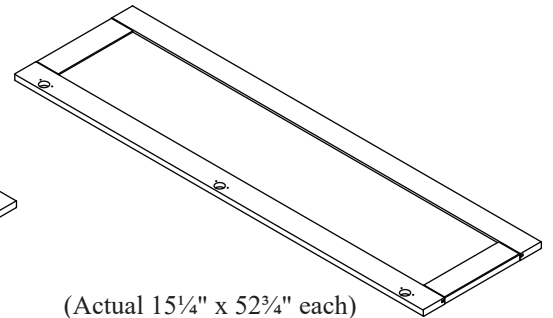

(Actual 15 1/4" x 52 3/4" each)

30" x 80" Shaker Door Assembly

432598 White Kit
 432599 White Doors only (2)
 432409 Slate Rift Kit
 431888 Slate Rift Doors only (2)
 432828 SP Mahog Kit
 432829 SP Mahog Door (2)
 432397 Hardware

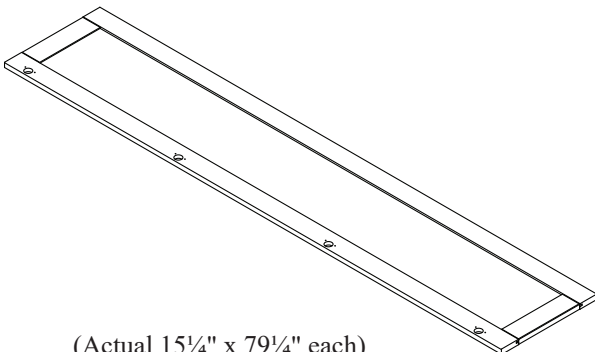

(Actual 15 1/4" x 79 1/4" each)

432383-18" Small Drawer Assembly

430841 Drawer box only
 432384 Hardware only

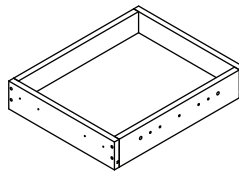

432385-24" Small Drawer Assembly

430842 Drawer box only
 432384 Hardware only

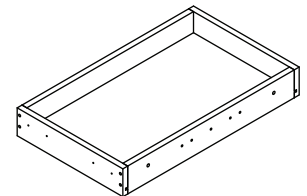

Parts Identification

432386-30" Small
Drawer Assembly
430843 Drawer box only
432384 Hardware only

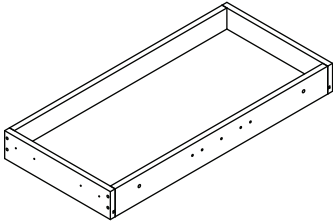

432387-18" Large
Drawer Assembly
430844 Drawer box only
432384 Hardware only

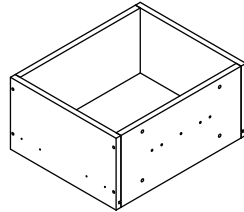

432389-24" Large
Drawer Assembly
430845 Drawer box only
432384 Hardware only

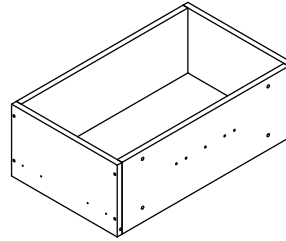

432390-30" Large
Drawer Assembly
430846 Drawer box only
432384 Hardware only

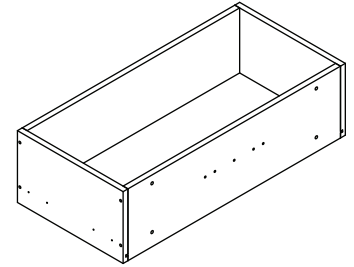

432391-24" Hutch Small
Drawer Assembly
431655 Drawer box only
432392 Hardware only

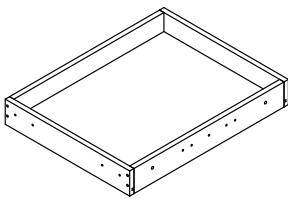

432393-30" Hutch Small
Drawer Assembly
431656 Drawer box only
432392 Hardware only

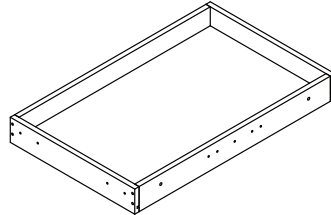

432394-24" Hutch Large
Drawer Assembly
431657 Drawer box only
432392 Hardware only

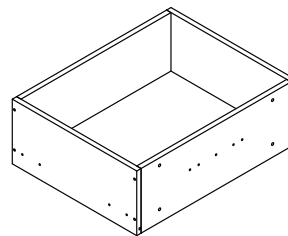

432395-30" Hutch Large
Drawer Assembly
431658 Drawer box only
432392 Hardware only

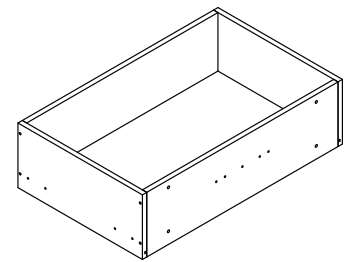

Crown Molding (classic)
432601 White
430874 Slate Rift
432831 Spice Mahogany

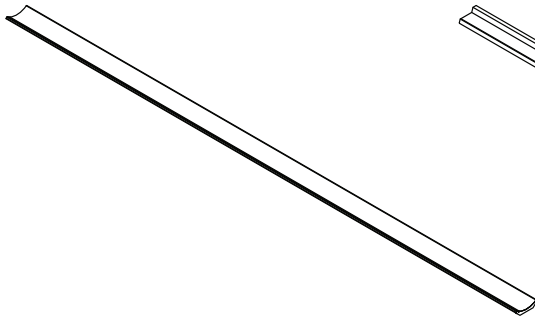

Crown Molding (shaker)
432600 White
430873 Slate Rift
432830 Spice Mahogany

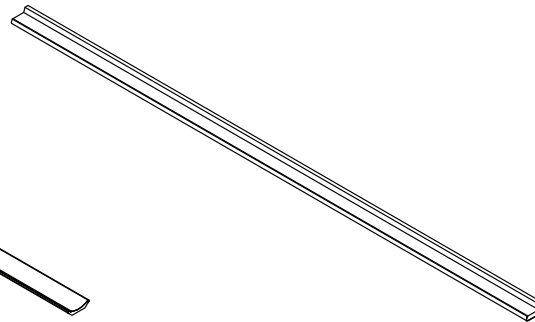

Stand Alone Island
430866 White
430865 Slate Rift
432066 Spice Mahogany

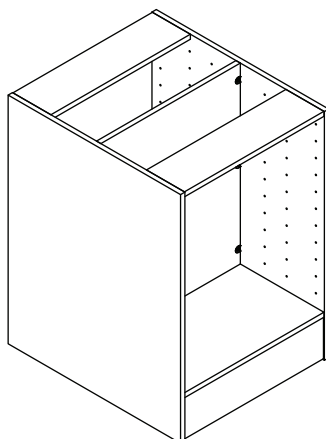

Bench
430868 White
430867 Slate Rift
432068 Spice Mahogany

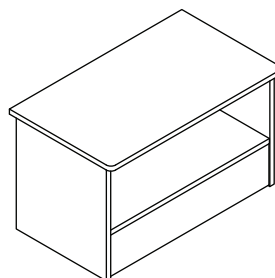

Hamper Kits
432604 White 24" Slab Door
432602 White 24" Shaker Door
432605 White 30" Slab Door
432603 White 30" Shaker Door
431874 Slate Rift 24" Slab Door
430875 Slate Rift 24" Shaker Door
431875 Slate Rift 30" Slab Door
430876 Slate Rift 30" Shaker Door
432834 Spice Mahogany 24" Slab Door
432832 Spice Mahogany 24" Shaker Door
432835 Spice Mahogany 30" Slab Door
432833 Spice Mahogany 30" Shaker Door

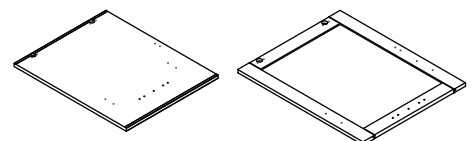

Hardware Identification

Shelf Cam

- 433145 White (2500)
- 433148 White (250)
- 433151 White (25)
- 433146_Bronze (2500)
- 433149 Bronze (250)
- 433152 Bronze (25)
- 433147_Brown (2500)
- 433150 Brown (250)
- 433153 Brown (25)

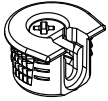

Push-In Dowel

- 433154 (5000)
- 433155 (250)
- 433156 (25)

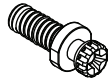

Screw-In Dowel

- 433157 Steel (4500)
- 433158 Steel (250)
- 433159 Steel (25)

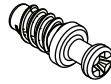

Double Dowel

- 433163 Steel (3000)
- 433164 Steel (250)
- 433165 Steel (25)

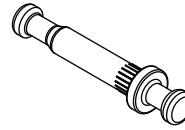

Bracket Only

- 433200 White (250)
- 433201 Brown (250)
- 433202 Black (250)

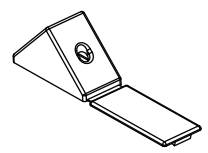

Bracket Kit

- 433203 White (10)
- 433204 Brown (10)
- 433205 Black (10)

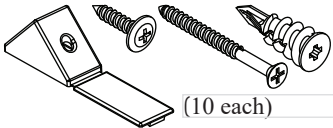

(10 each)

Toggle Anchor

- 431220

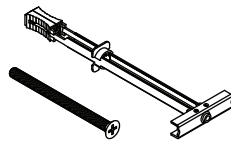

Extension Rail Template Kit

- 433169

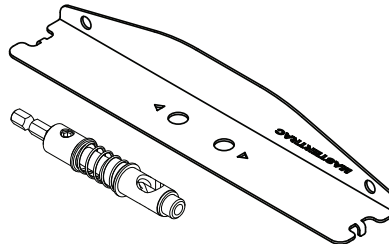

Corner Shelf

H-Joint Channel

- 433171 White (100)
- 433172 White (1)
- 433173 Bronze (100)
- 433174 Bronze (1)
- 433175 Brown (100)
- 433176 Brown (1)

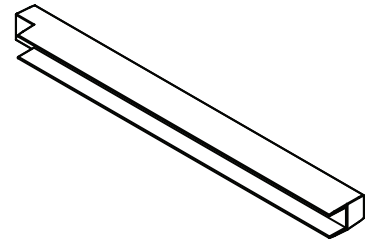

Cleat Dowel Boring Jig

- 433713

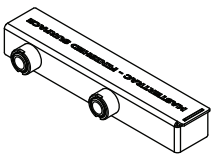

Cam Jig Install Kit

- 433170 Zinc

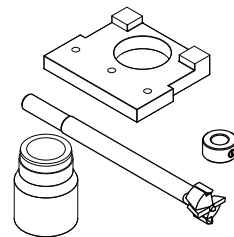

Rolled Edge Banding

- 429614 White
- 432854 Slate Rift
- 432855 Spice Mahogany

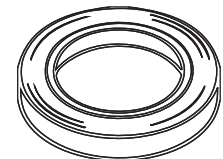

2-3/4" Flat Head Screw

- 433179 (250)
- 433180 (25)

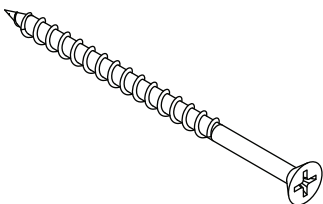

5/16" Euro Screw

- 433182 (250)
- 433183 (25)



5/8" Flat Head Screw

- 433378 (250)
- 433377 (25)



Hinge Kit

- 432396 (6 hinge pack)
- 432397 (8 hinge pack)

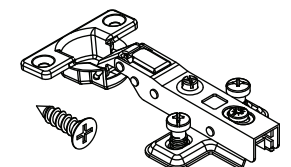

Hardware Identification

18" Extension Rail Kit
432392

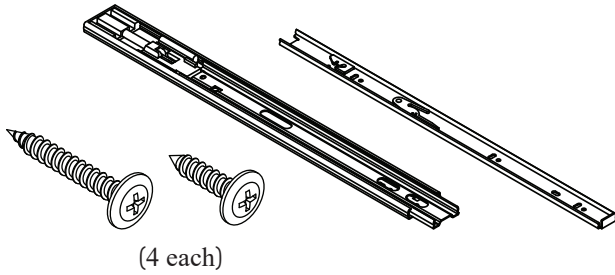

14" Extension Rail Kit
432384

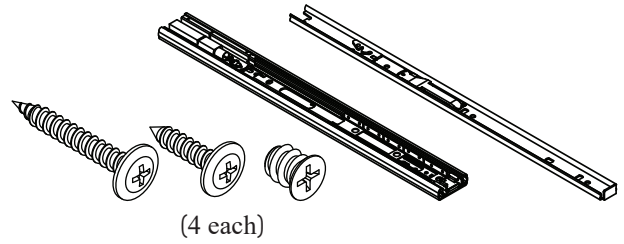

8' Rod
419786 Chrome (10)
432931 Matt Nickel (12)
432932 Matt Nickel (1)
433223 Chrome (1)

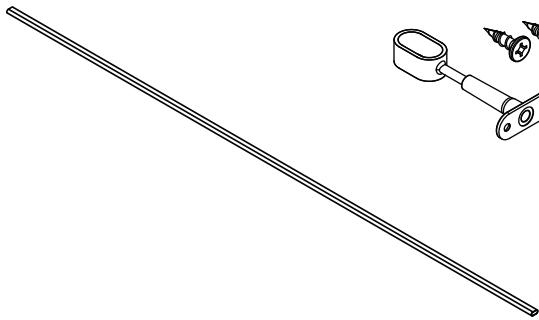

Curved Oval Rod Kit
433701 Steel (1)

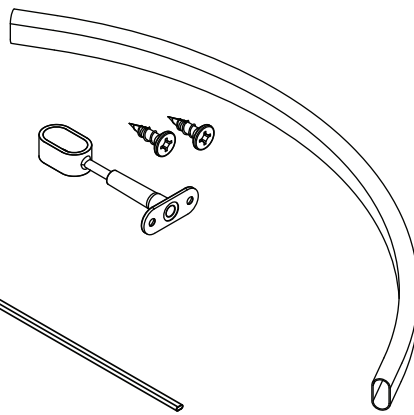

Rod Cup
432933 Matt Nickel (200)
432934 Matt Nickel (10)
433224 Chrome (200)
433225 Chrome (10)

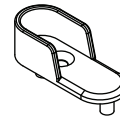

Shelf Support
432935 (500)
432937 Nickel (50)



Contemporary Pull
433189 Brushed Nickel
433190 Polished Chrome
433191 Matt Gold
433192 Matt Black
433193 Matt Chrome

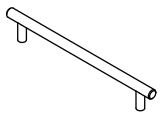

Pull
433194 Polished Chrome
433195 Matt Black
433196 Brushed Brass
433197 Stainless Steel

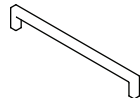

Knob
433184 Matt Nickel
433185 Slate
433186 Polished Chrome
433187 Matt Gold
433188 Matt Aluminum



Applique 5 Pack
432856 White
432857 Slate Rift
432858 Spice Mahogany

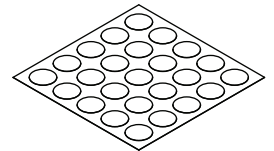

Wood Dowel
433700 (250)
433699 (25)

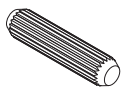

Valet Rod
432914 White
432915 Polished Chrome
432916 Matt Aluminum

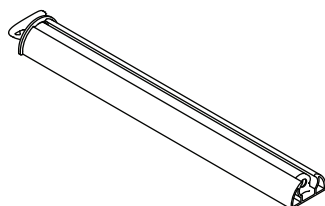

24" Jewelry Liner
429517

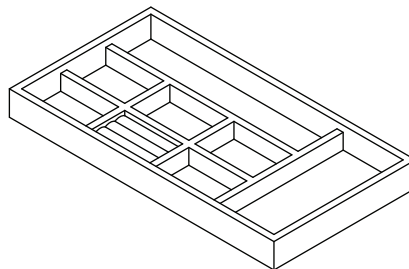

30" Jewelry Liner
429519

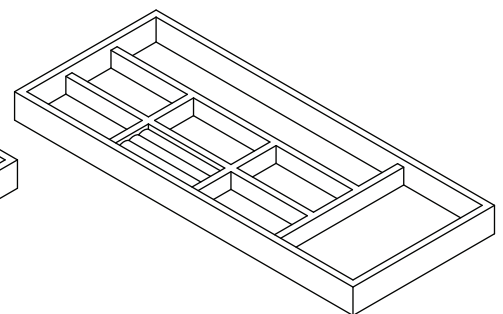

Hardware Identification

Coat Hook

432906 Matt Aluminum
432907 Polished Chrome



Double Hook

432909 Matt Aluminum
432908 Polished Chrome



Waterfall Hook

432912 Polished Chrome
432913 Matt Aluminum



Broom Holder

432910 White
432911 Grey

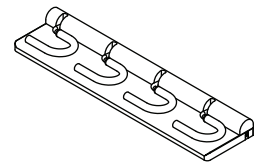

Sliding Scarf Rack

432923 Polished Chrome
432924 Matt Aluminum

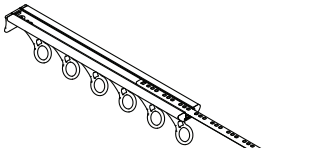

Sliding Tie Rack

432917 White
432918 Polished Chrome
432919 Matt Aluminum

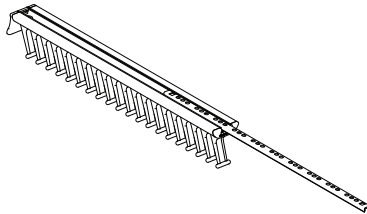

Sliding Belt Rack

432920 White
432921 Polished Chrome
432922 Matt Aluminum

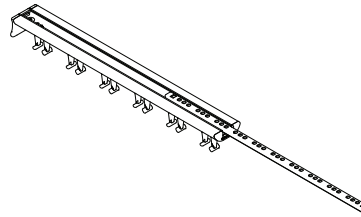

6" x 18" Basket

432897

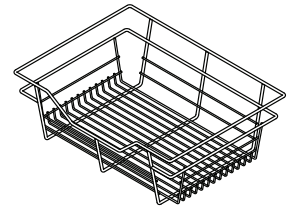

6" x 24" Basket

432900

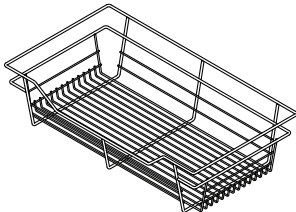

6" x 30" Basket

432903

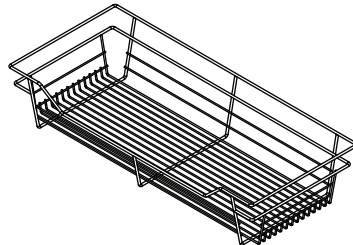

11" x 18" Basket

432898



11" x 24" Basket

432901

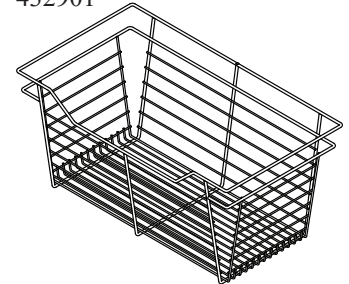

11" x 30" Basket

432904

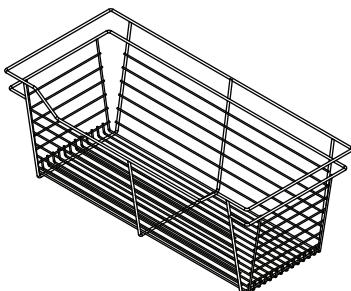

17" x 18" Basket

432899



17" x 24" Basket

432902



17" x 30" Basket

432905



Hardware Usage Guide

⚠ Caution

Risk of damage or injury. CONNECTORS must be completely tightened. CONNECTORS that are not completely tightened may loosen, and parts may separate.

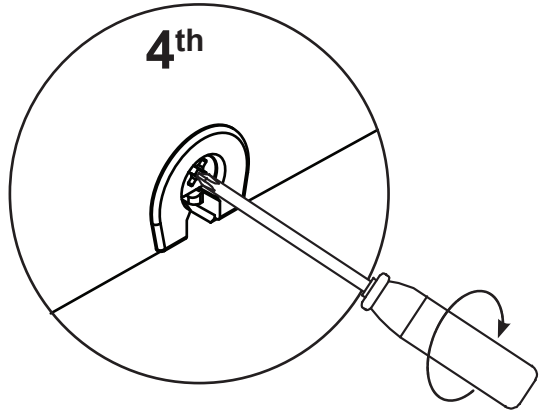
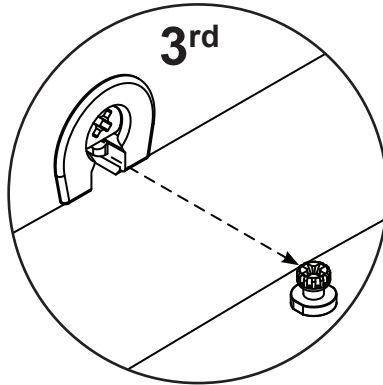
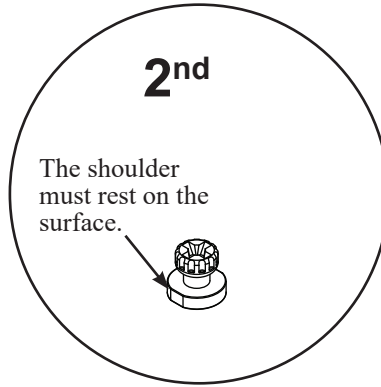
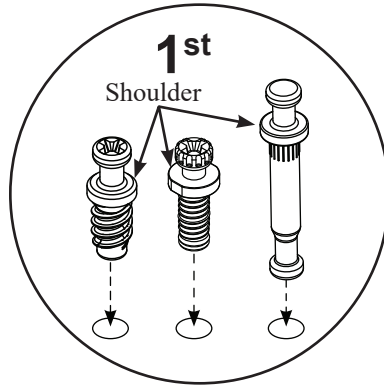

The shoulder will always be farthest away from the Corner Upright.

A Double Dowel is required in the exact orientation between two Fixed shelves that are horizontally inline.

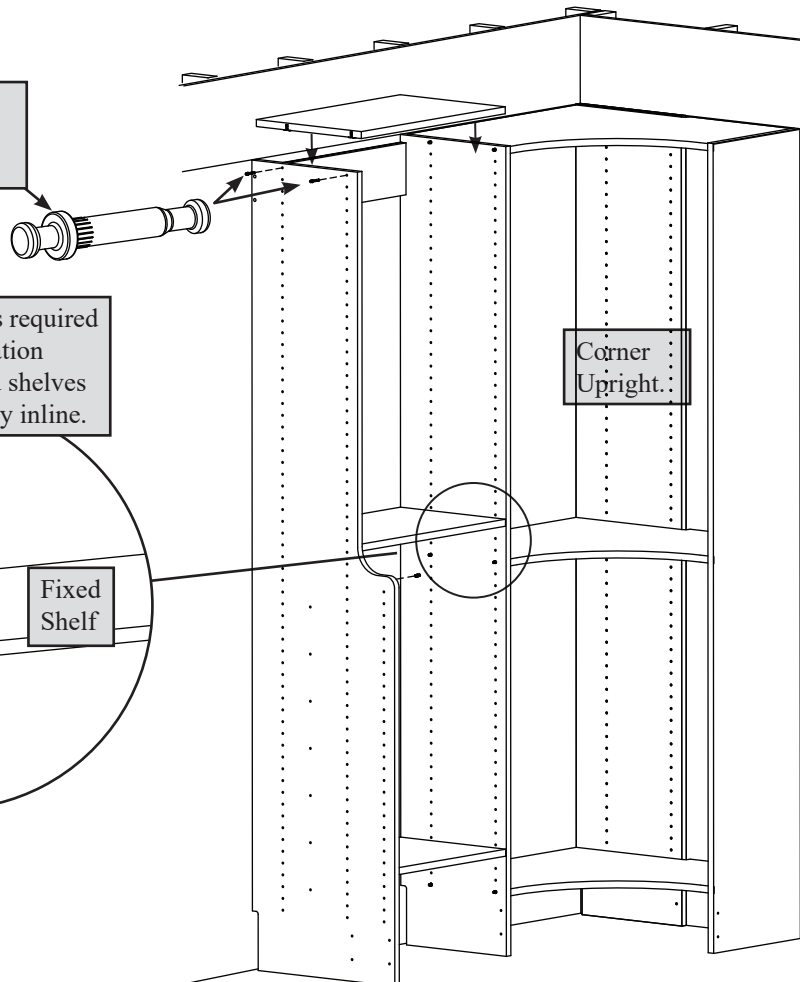
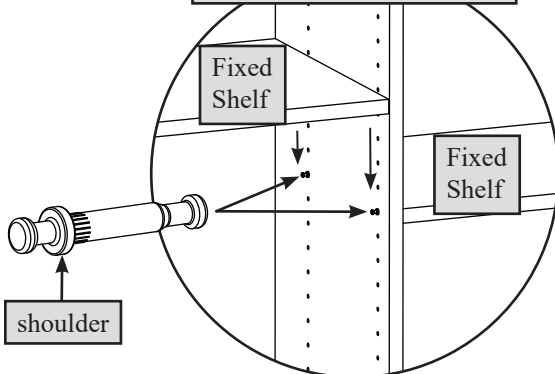

Floor Cabinet Installation

Diagram #1
Completed Sample
view of Floor Cabinet
Configuration

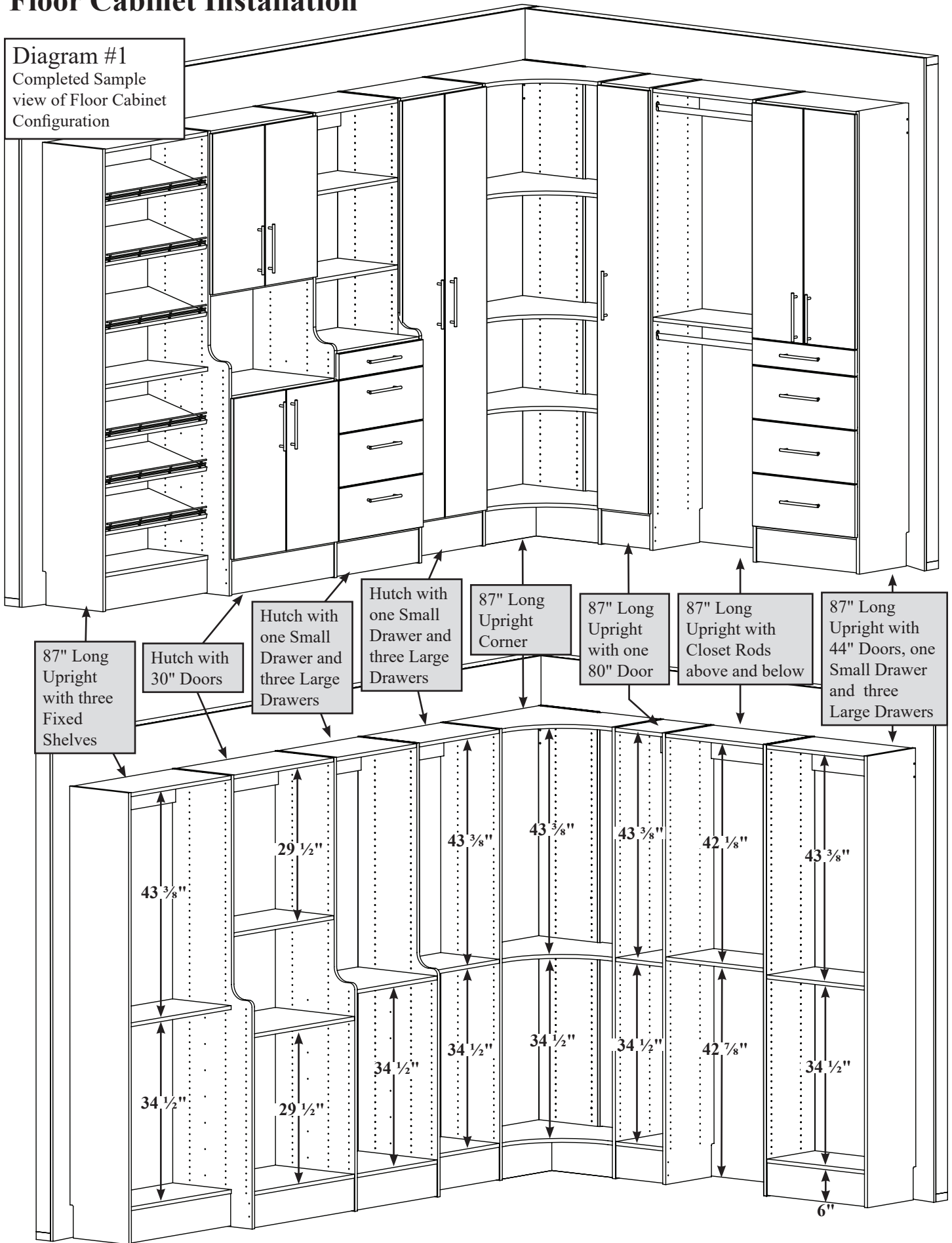

Floor Cabinet Hardware Preparation

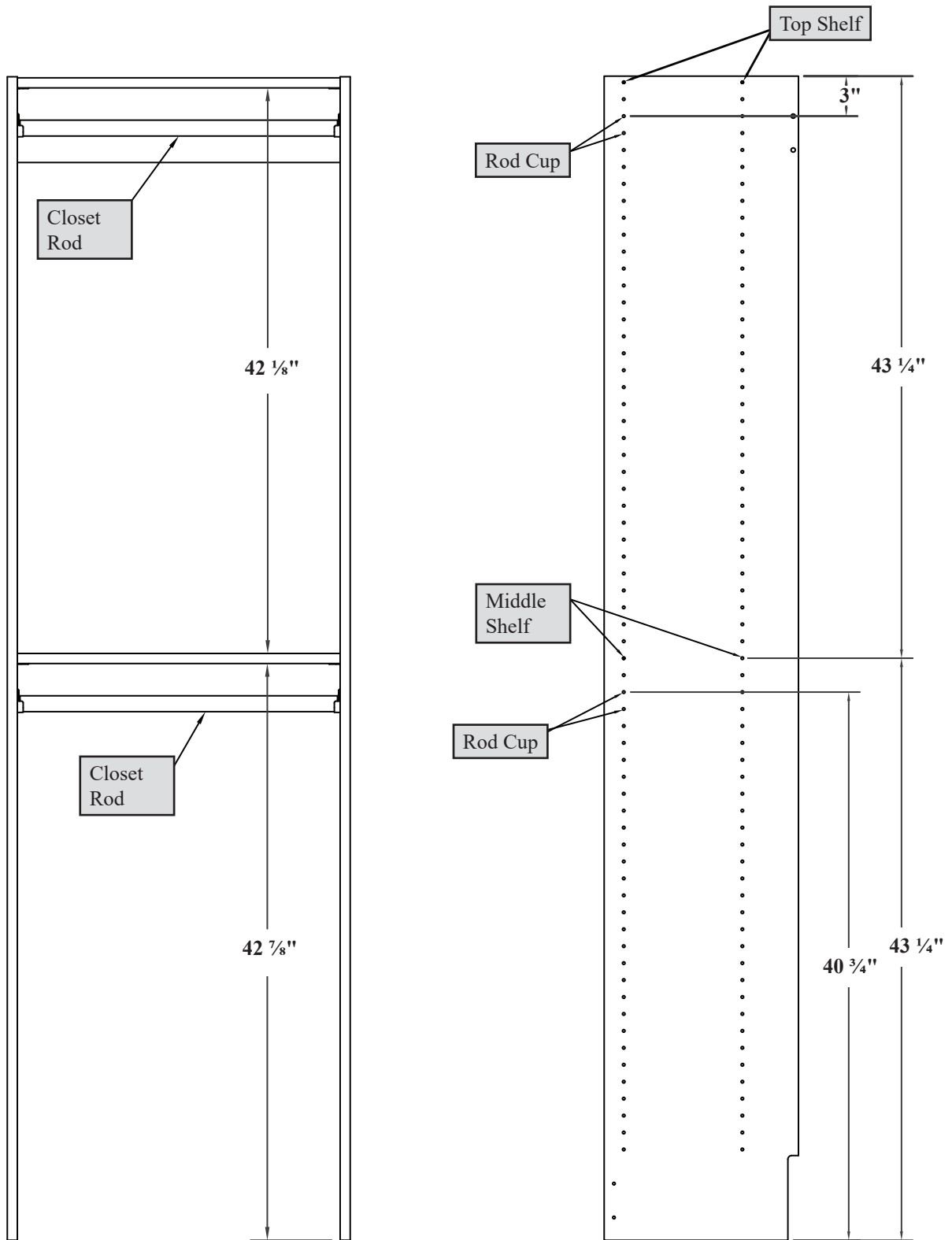

In pages 15-34 we will be building the carcass of the Sample view configuration. Refer to the Table of contents for specific applications necessary to complete your installation of Hardware, Doors, Drawers, Closet Rods, Adjustable Shelves modifying Fixed Shelves, Toe Kicks and Cleats.

Floor Cabinet Hardware Preparation

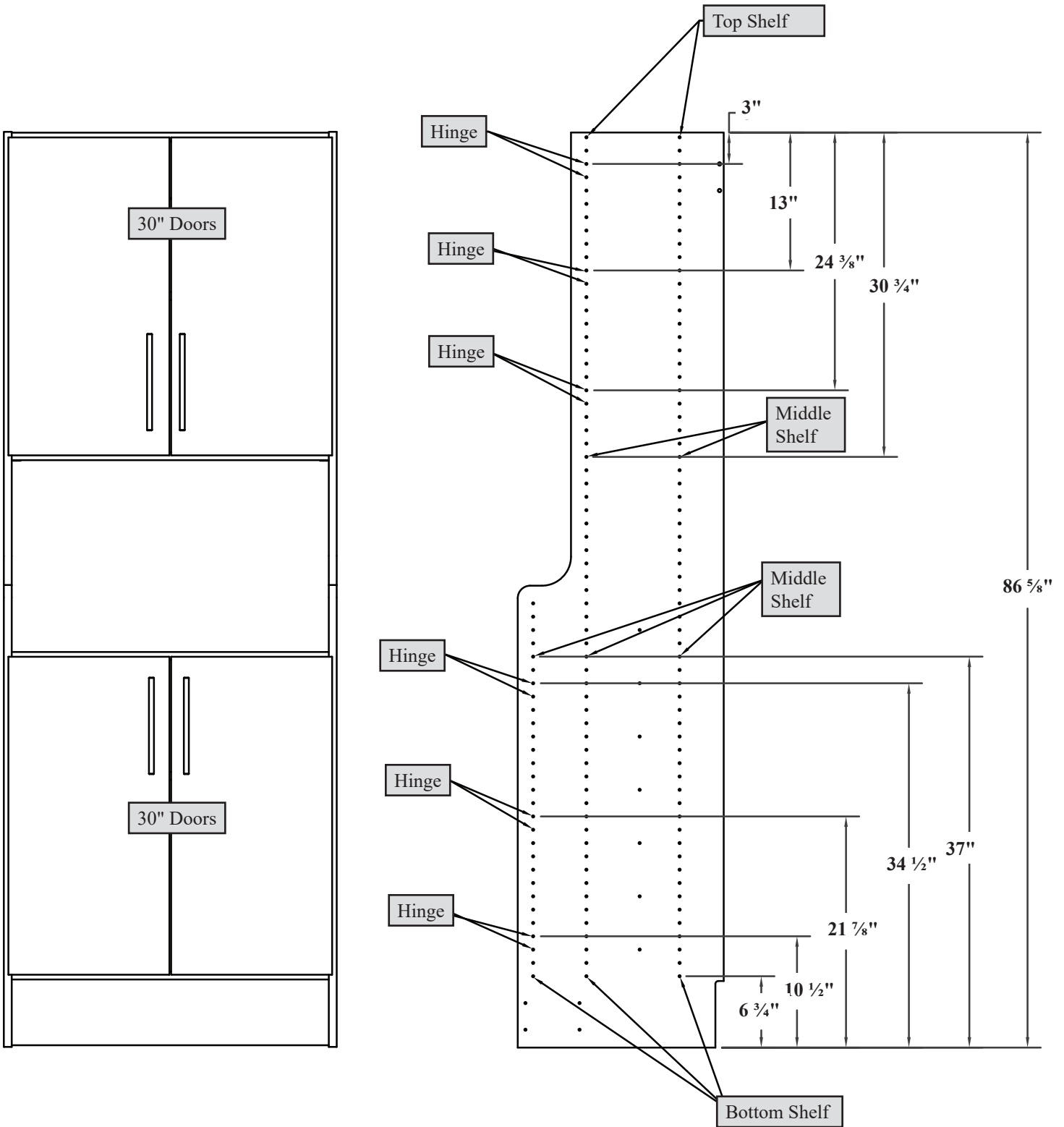

Floor Cabinet Hardware Preparation

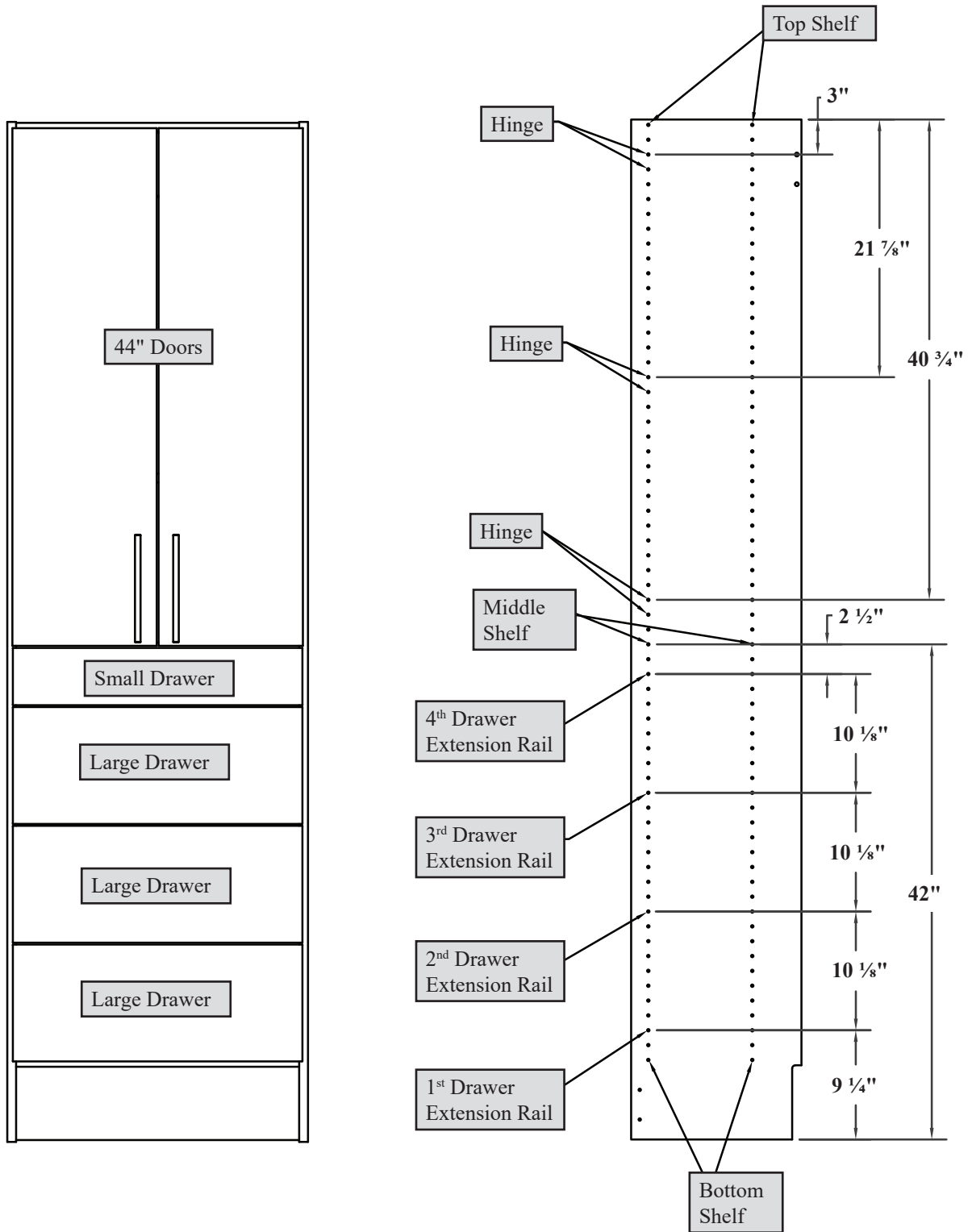

Floor Cabinet Hardware Preparation

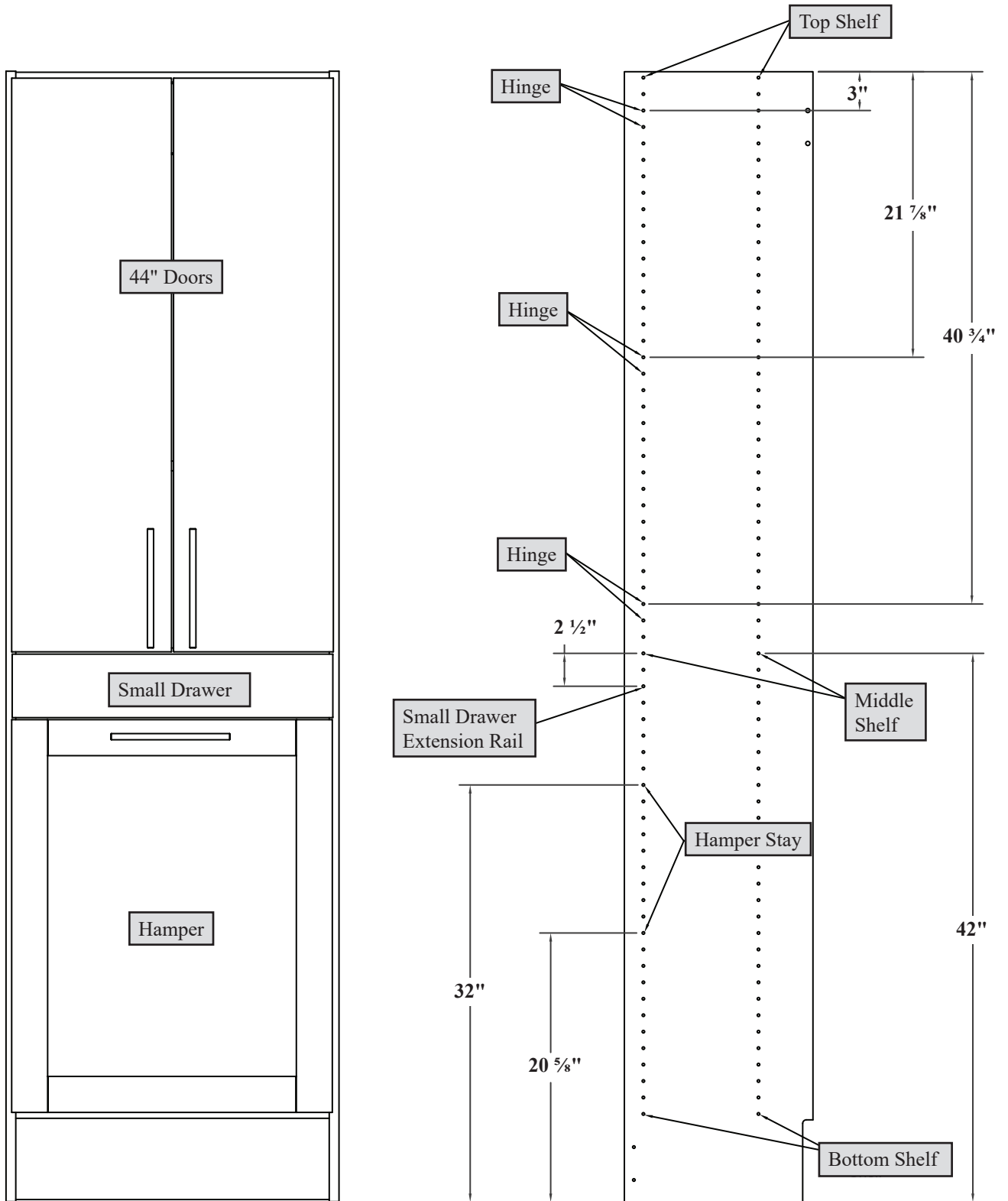

Floor Cabinet Installation

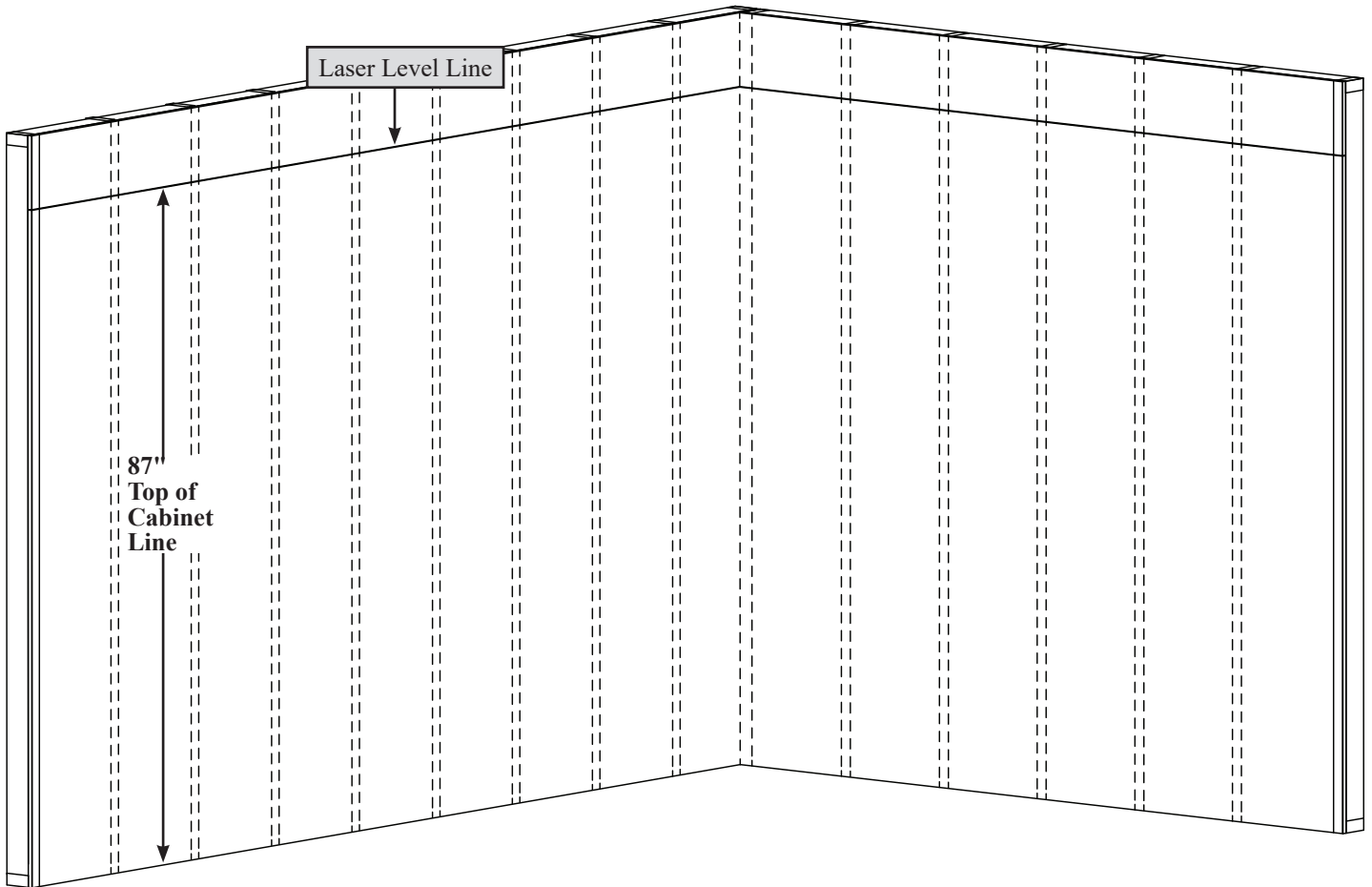

With a level or laser, create a line 87" off the floor onto your wall to indicate the top edge of the cabinets

NOTE: As you build your Floor Cabinets, you may need to shim underneath the Uprights to stay level with the line keeping the Uprights plumb.

Floor Cabinet Installation

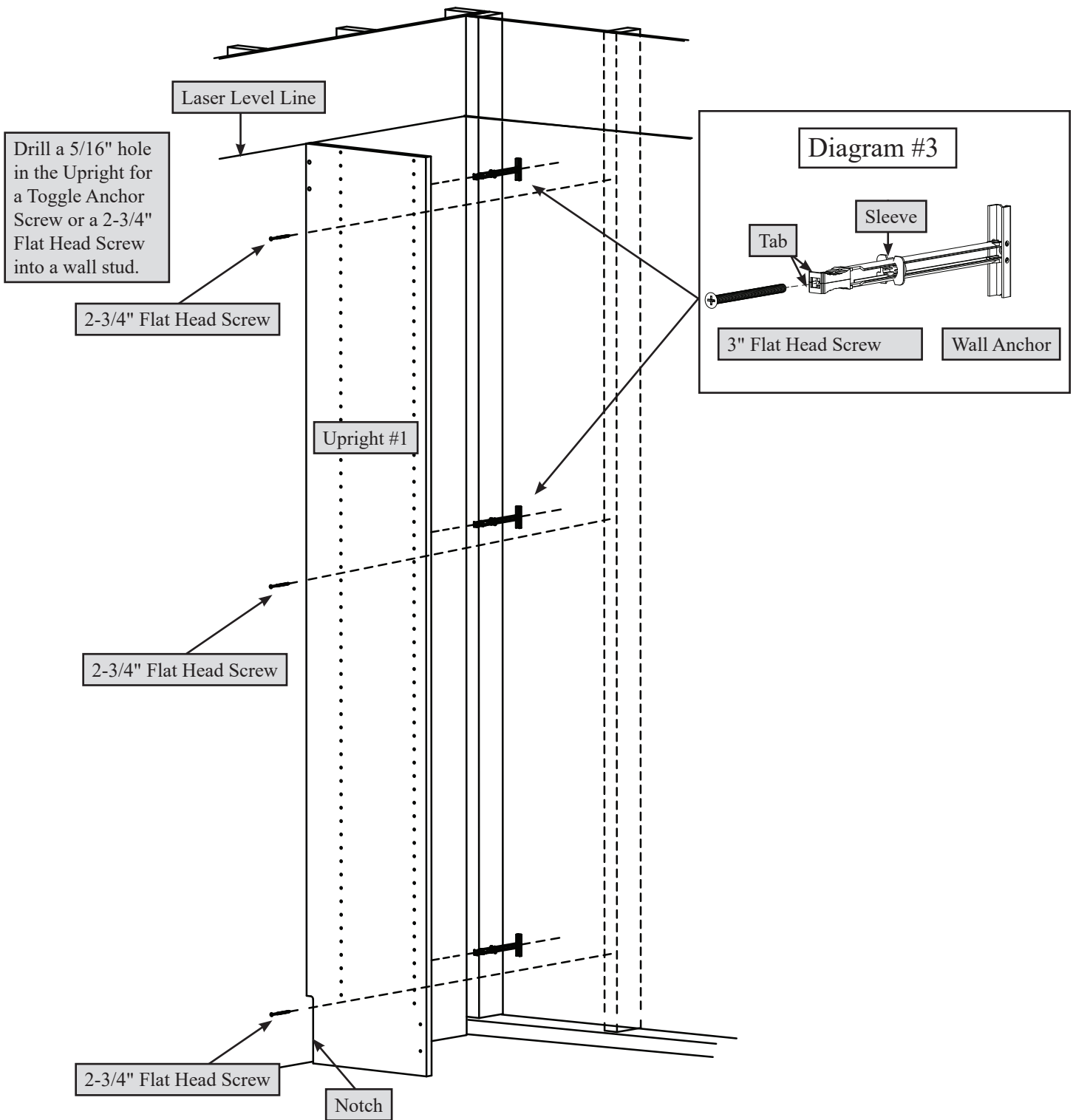

Fasten Upright #1 to the wall with three 2-3/4" Flat Head Screws into wall studs. Use three Toggle Anchors if a wall stud is not available.

Diagram #3

The Toggle Anchor requires 1/2" hole in the drywall. Push the Toggle Anchor into the hole, slide the Sleeve to the drywall and break off the Tabs of the Toggle Anchor.

Floor Cabinet Installation

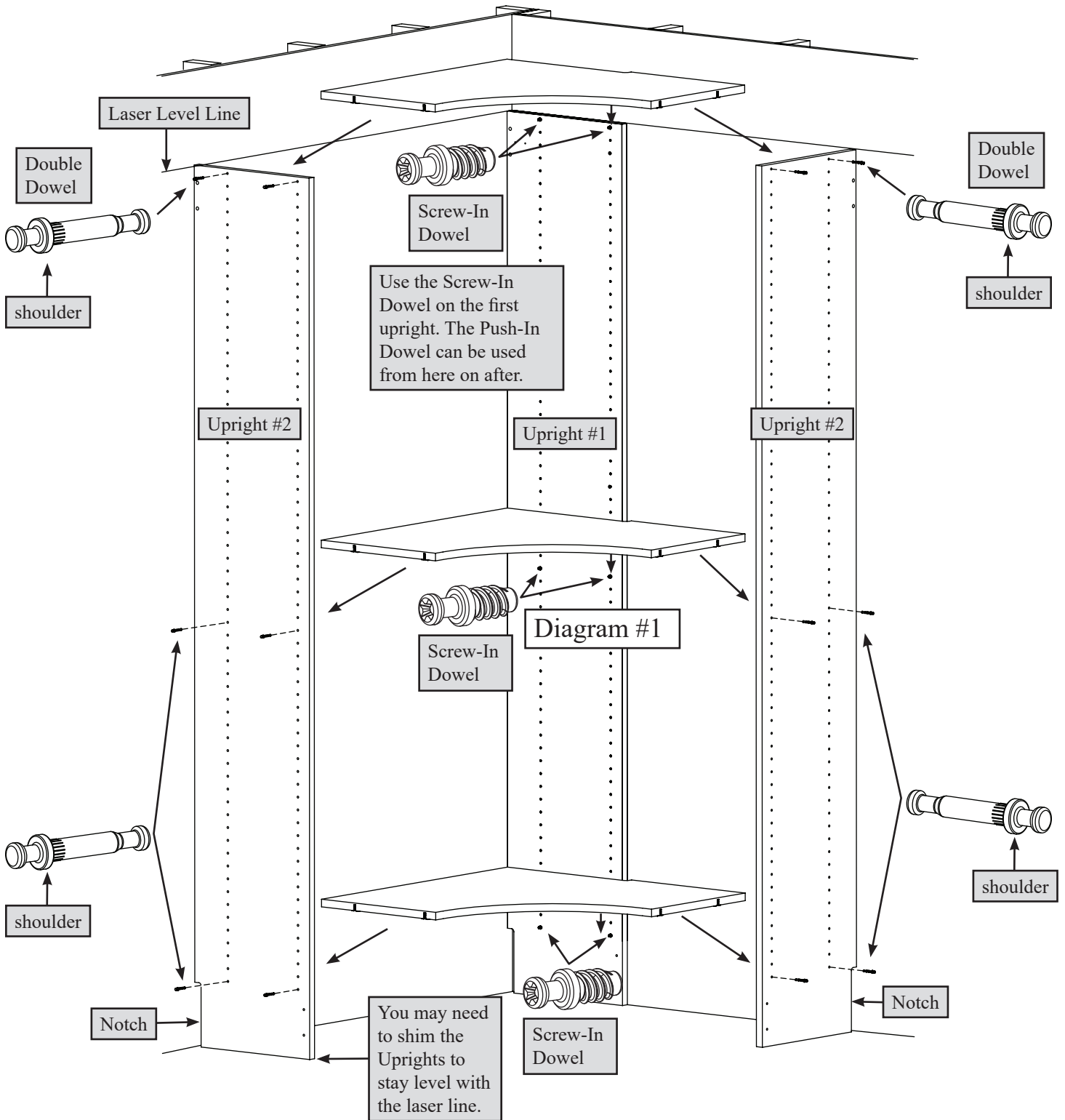

Turn four Screw-in Dowels into the top holes and bottom holes of the corner Upright. Turn additional Screw-In Dowels into the holes per Design in Diagram #1 for placement of the Fixed Shelf.

Insert twelve Double Dowels completely into the holes in the Uprights #1 and #2.

Fasten the Fixed Shelves to the Uprights. Tighten twelve Connectors.

Floor Cabinet Installation

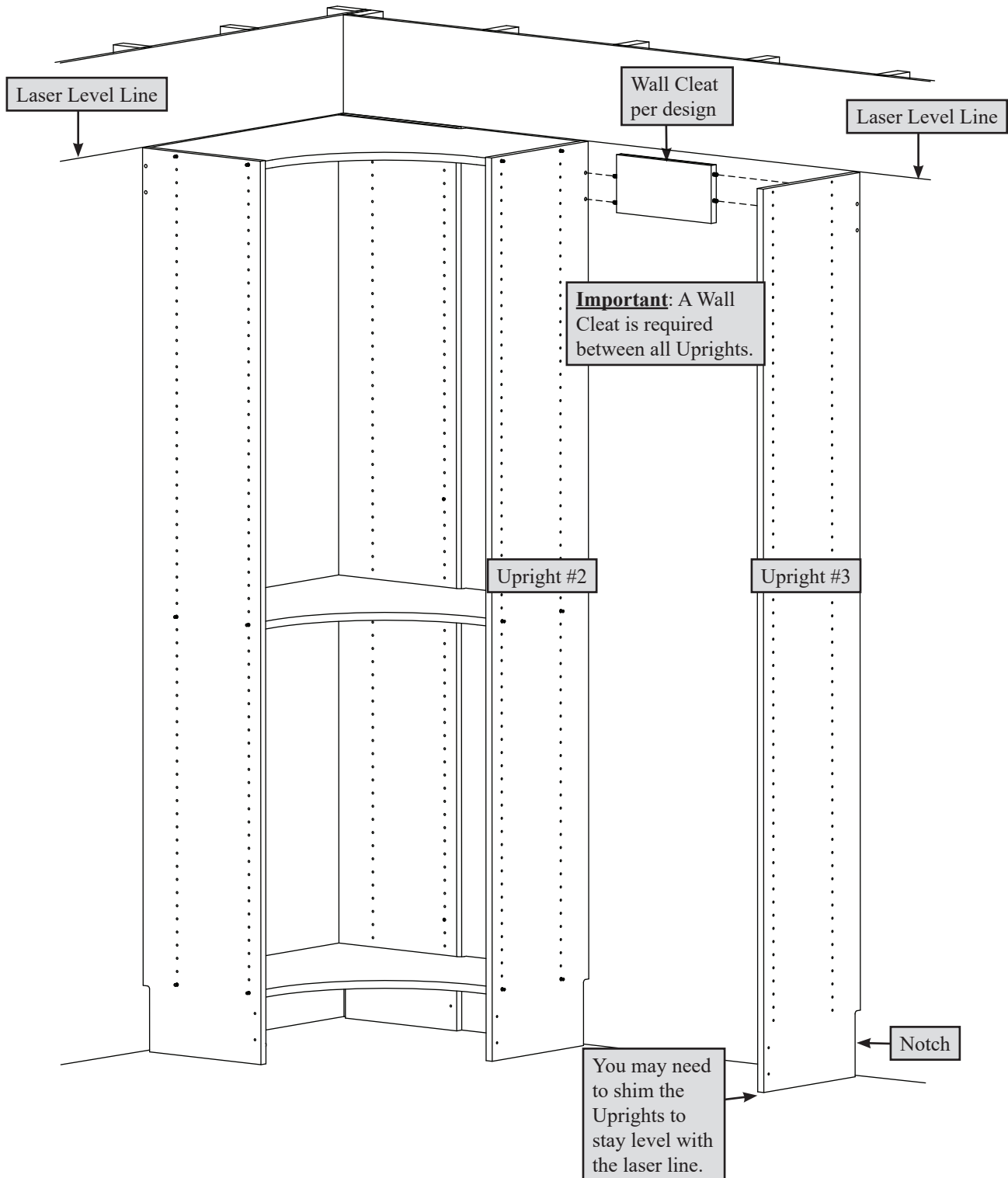

Wall Cleats come with pre-glue dowels in them. Fasten a Wall Cleat to Uprights #2 and #3 by pushing the wood dowels in the Wall Cleat into the Uprights.

Important: A Wall Cleat is required between all Uprights.

Note: Wall Cleats will be anchored to the wall after all Uprights and Fixed Shelves are hung on page 34.

Floor Cabinet Installation

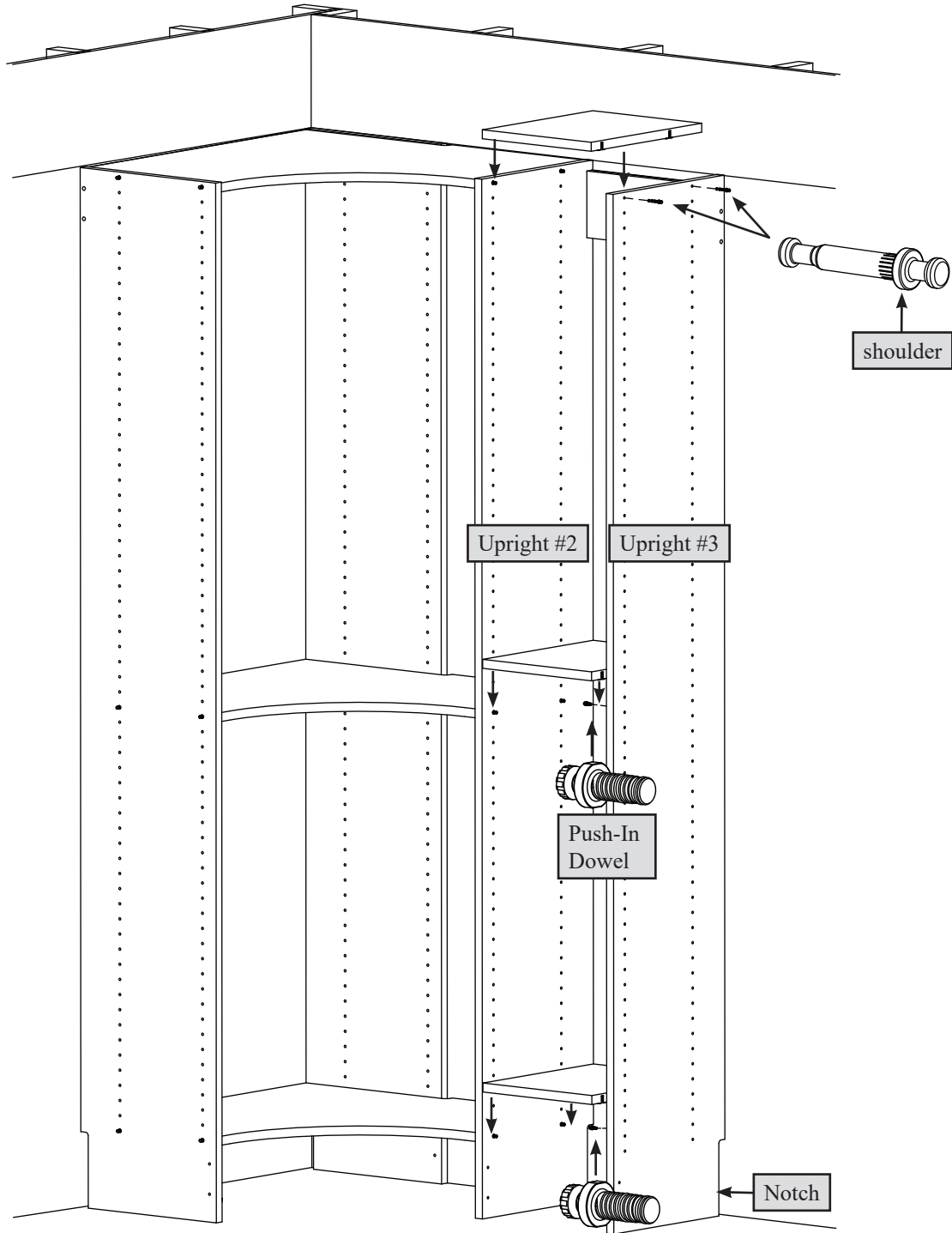

Insert two Double Dowels completely into the holes in Upright #3.

Insert four Push-In Dowels completely into the holes in the Upright #3.

Fasten three Fixed Shelves to Upright #2 and #3. Tighten twelve Connectors

Floor Cabinet Installation

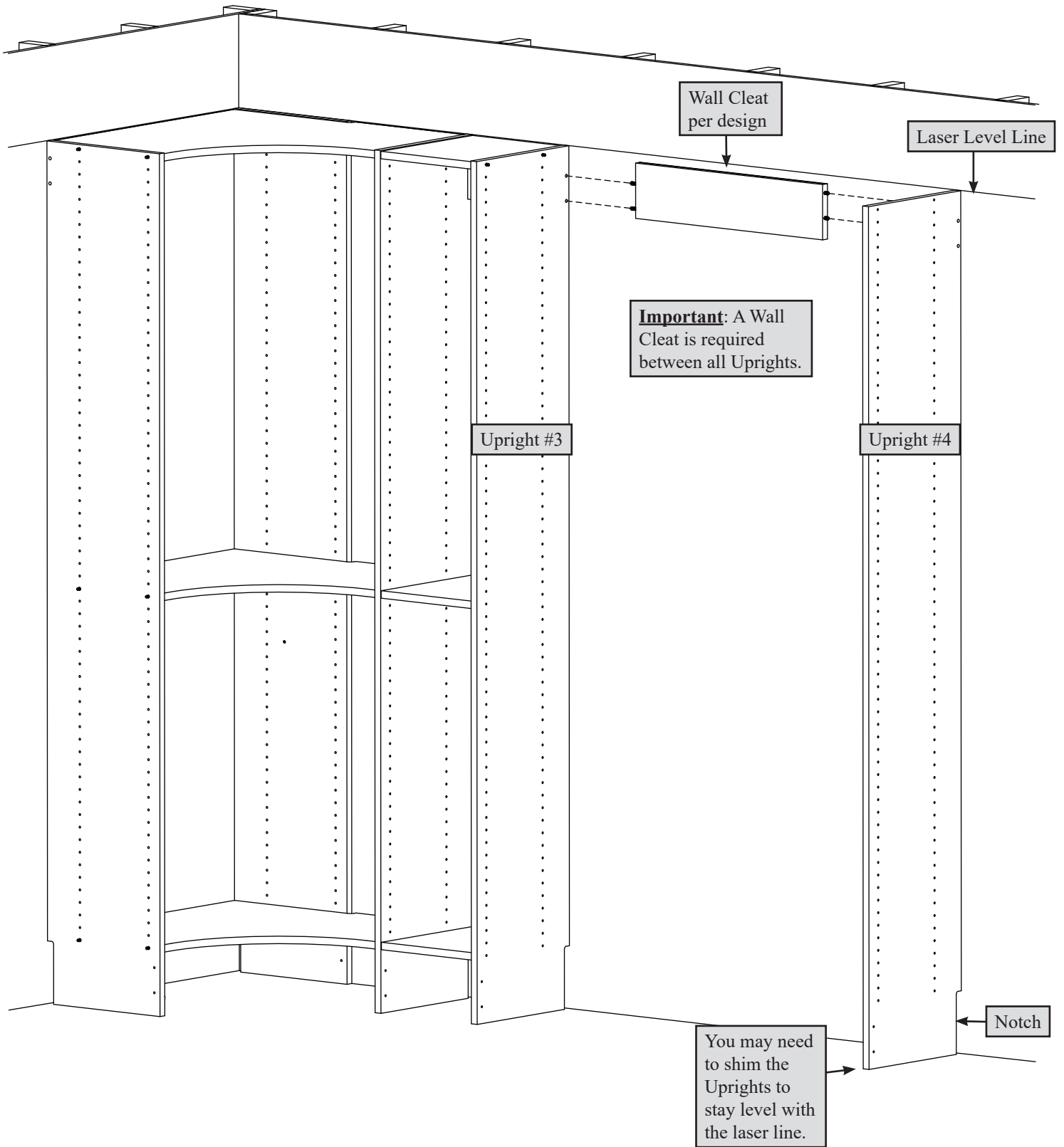

Fasten the Wall Cleat to Uprights #3 and #4 by pushing the wood dowels in the Wall Cleat into the Uprights.

Important: A Wall Cleat is required between all Uprights.

Note: Wall Cleats will be anchored to the wall after all Uprights and Fixed Shelves are hung on page 34.

Floor Cabinet Installation

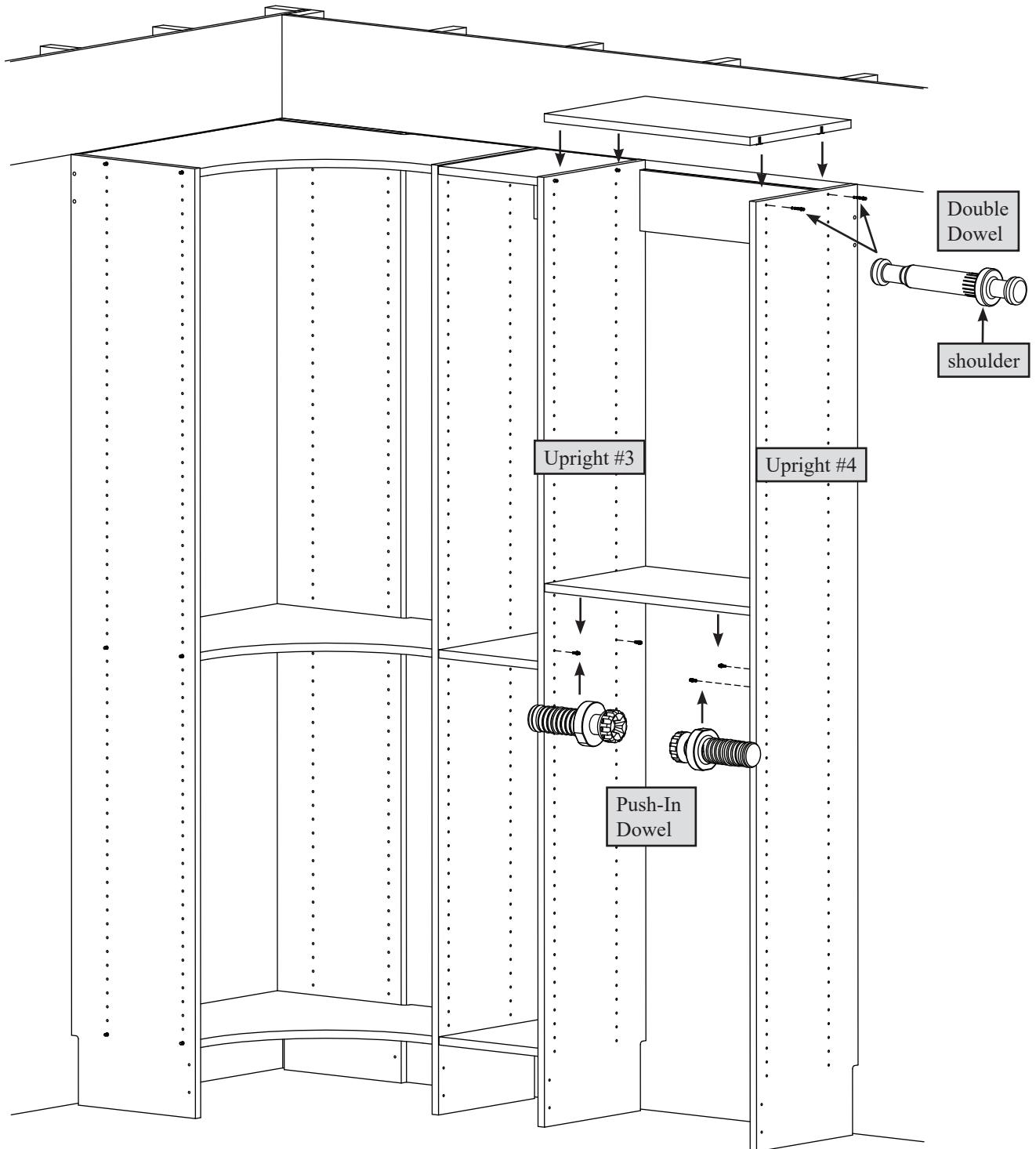

Insert two Double Dowels completely into the holes in Upright #4.

Insert four Push-In Dowels completely into the holes in Uprights #3 and #4.

Fasten two Fixed Shelves to Uprights #3 and #4. Tighten eight Connectors.

Floor Cabinet Installation

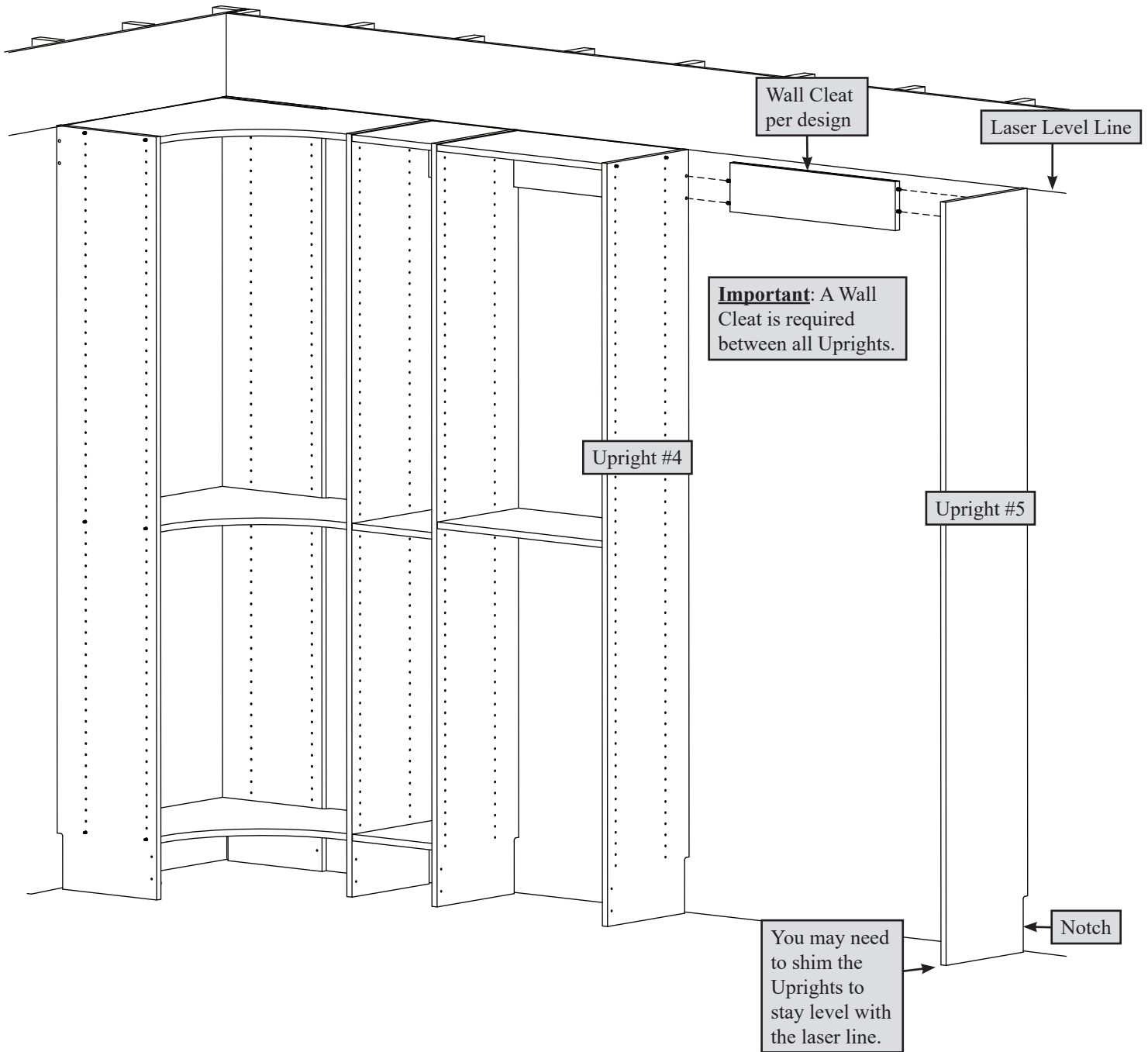

Fasten the Wall Cleat to the Uprights by pushing the wood dowels in the Wall Cleat into Uprights #4 and #5.

Important: A Wall Cleat is required between all Uprights.

Note: Wall Cleats will be anchored to the wall after all Uprights and Fixed Shelves are hung on page 34.

Floor Cabinet Installation

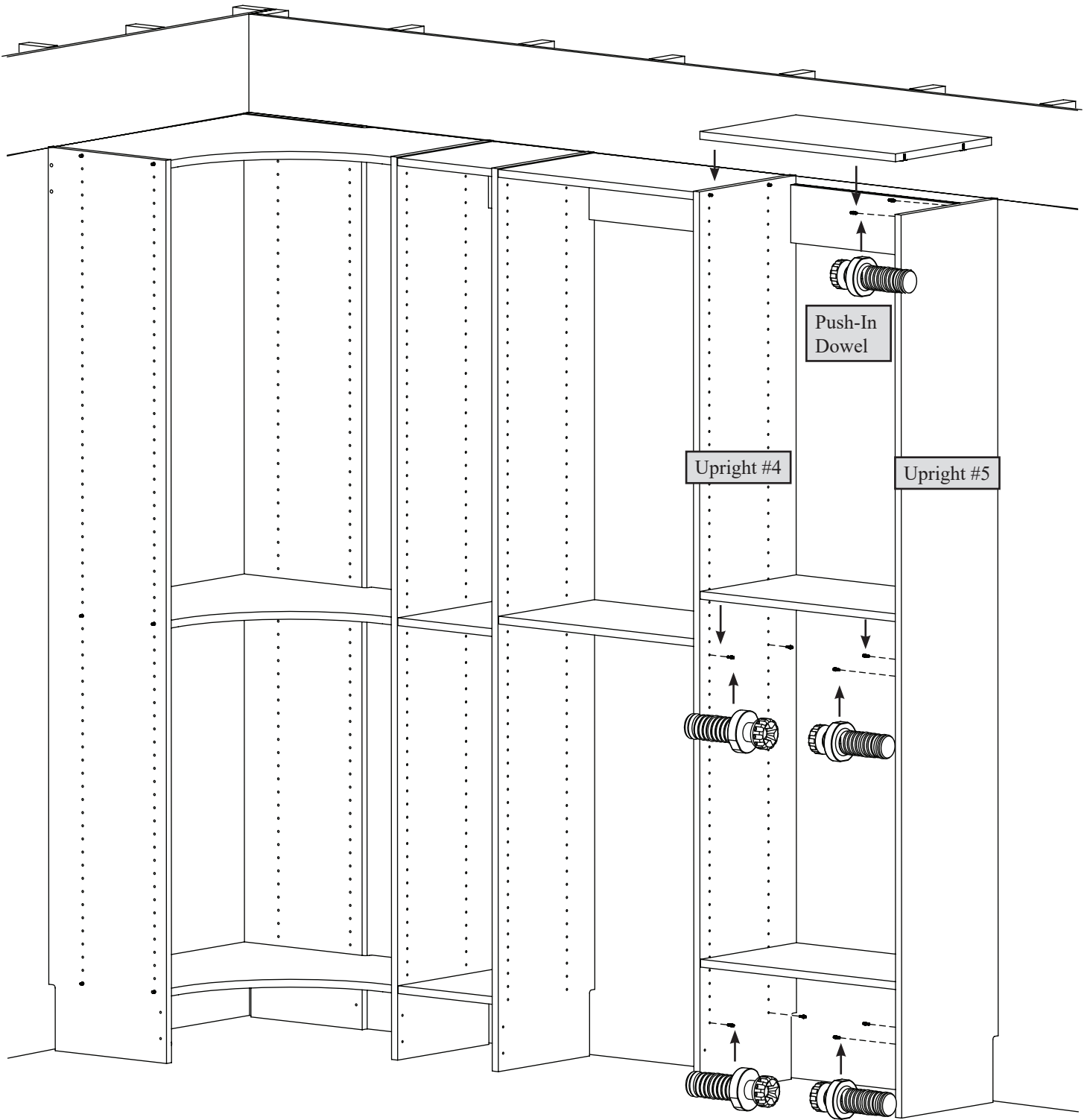

Insert ten Push-In Dowels completely into the holes in Uprights #4 and #5.

Fasten three Fixed Shelves to Uprights #4 and #5. Tighten twelve Connectors

Floor Cabinet Installation

Important: A Wall Cleat is required between all Uprights.

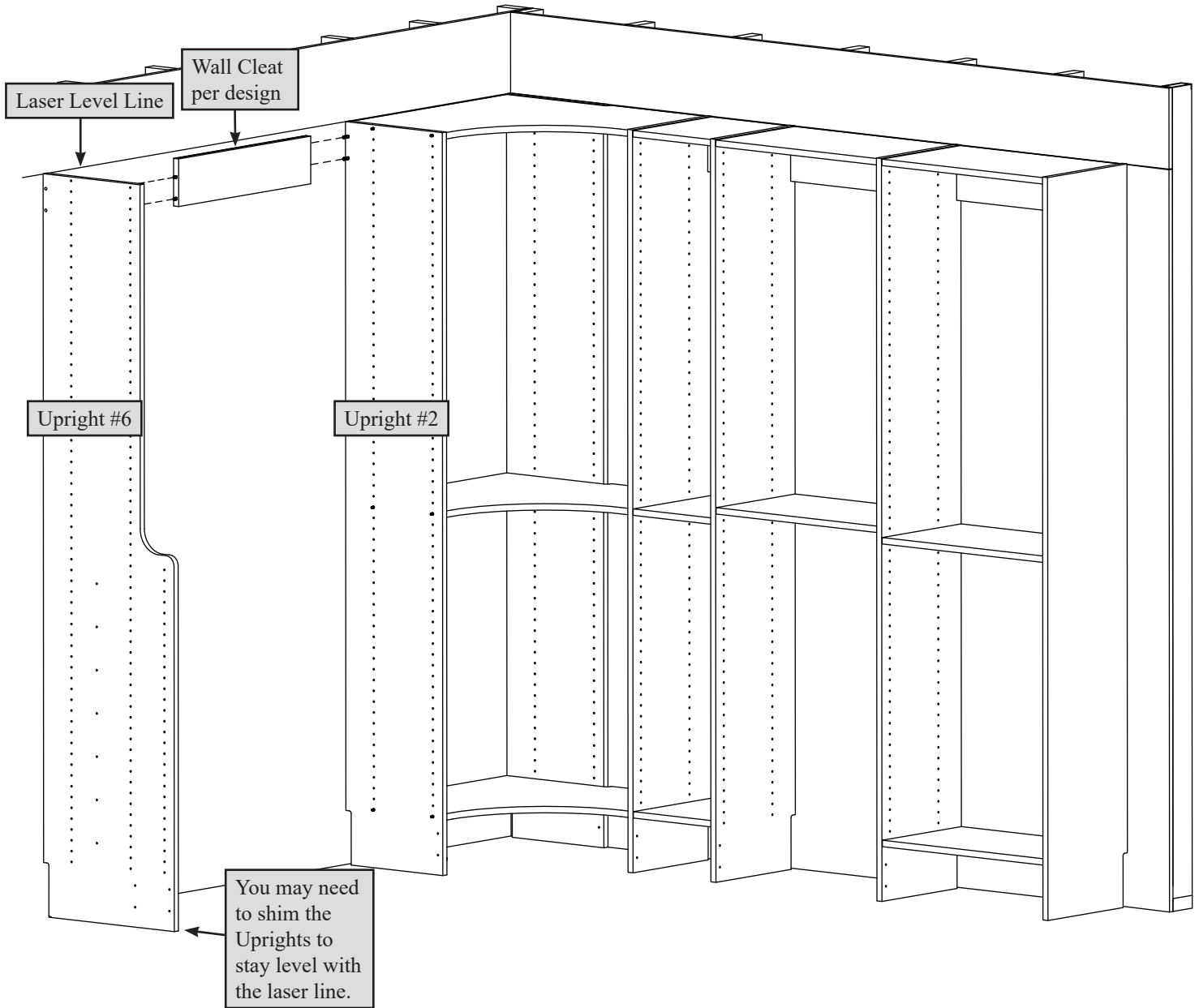

Fasten the Wall Cleat to the Uprights by pushing the wood dowels in the Wall Cleat into Uprights #2 and #6.

Important: A Wall Cleat is required between all Uprights.

Note: Wall Cleats will be anchored to the wall after all Uprights and Fixed Shelves are hung on page 34.

Floor Cabinet Installation

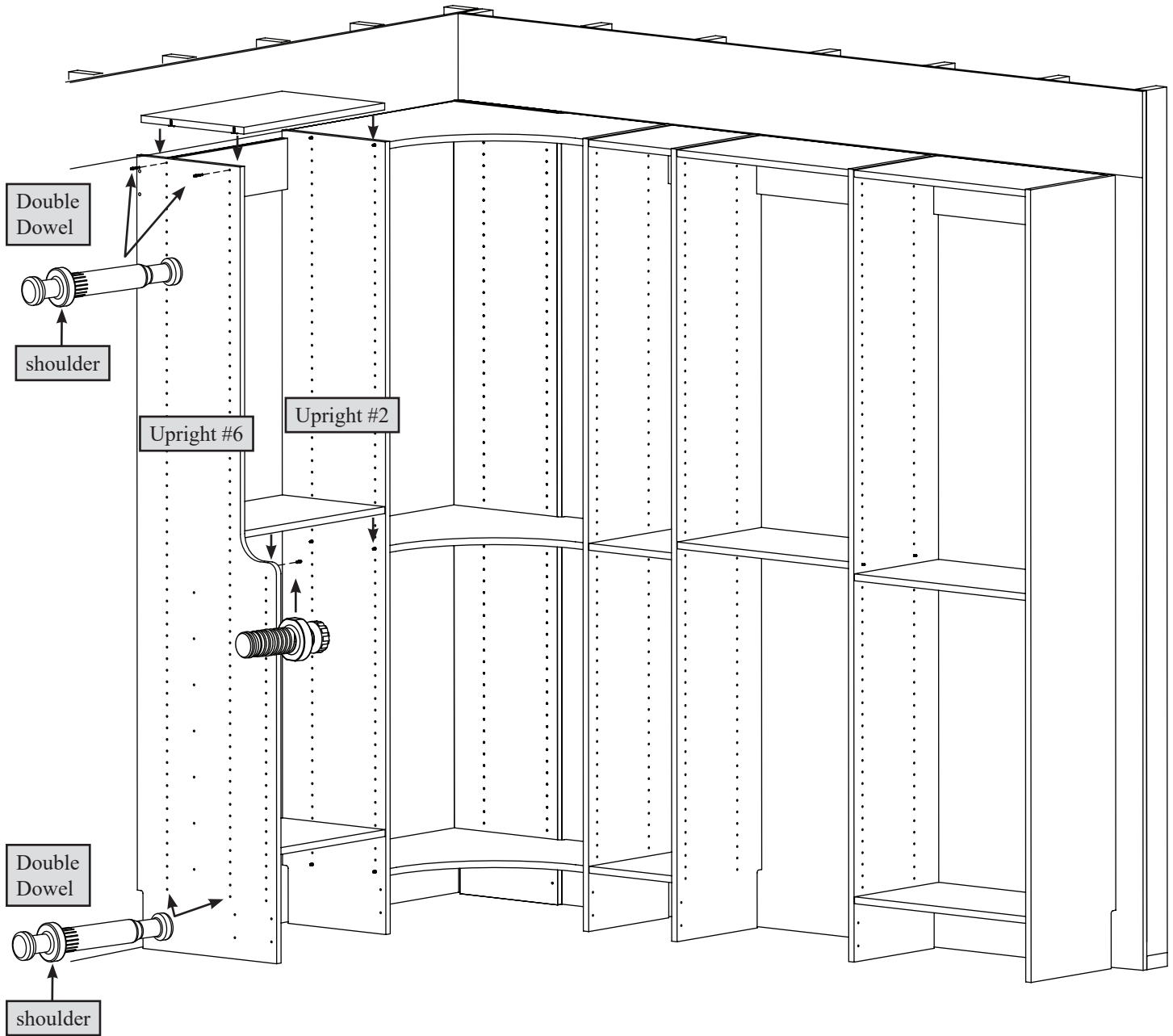

Insert four Double Dowels completely into the holes in Upright #6.

Insert two Push-In Dowels completely into the holes in Upright #6.

Fasten three Fixed Shelves to Uprights #2 and #6. Tighten twelve Connectors

Floor Cabinet Installation

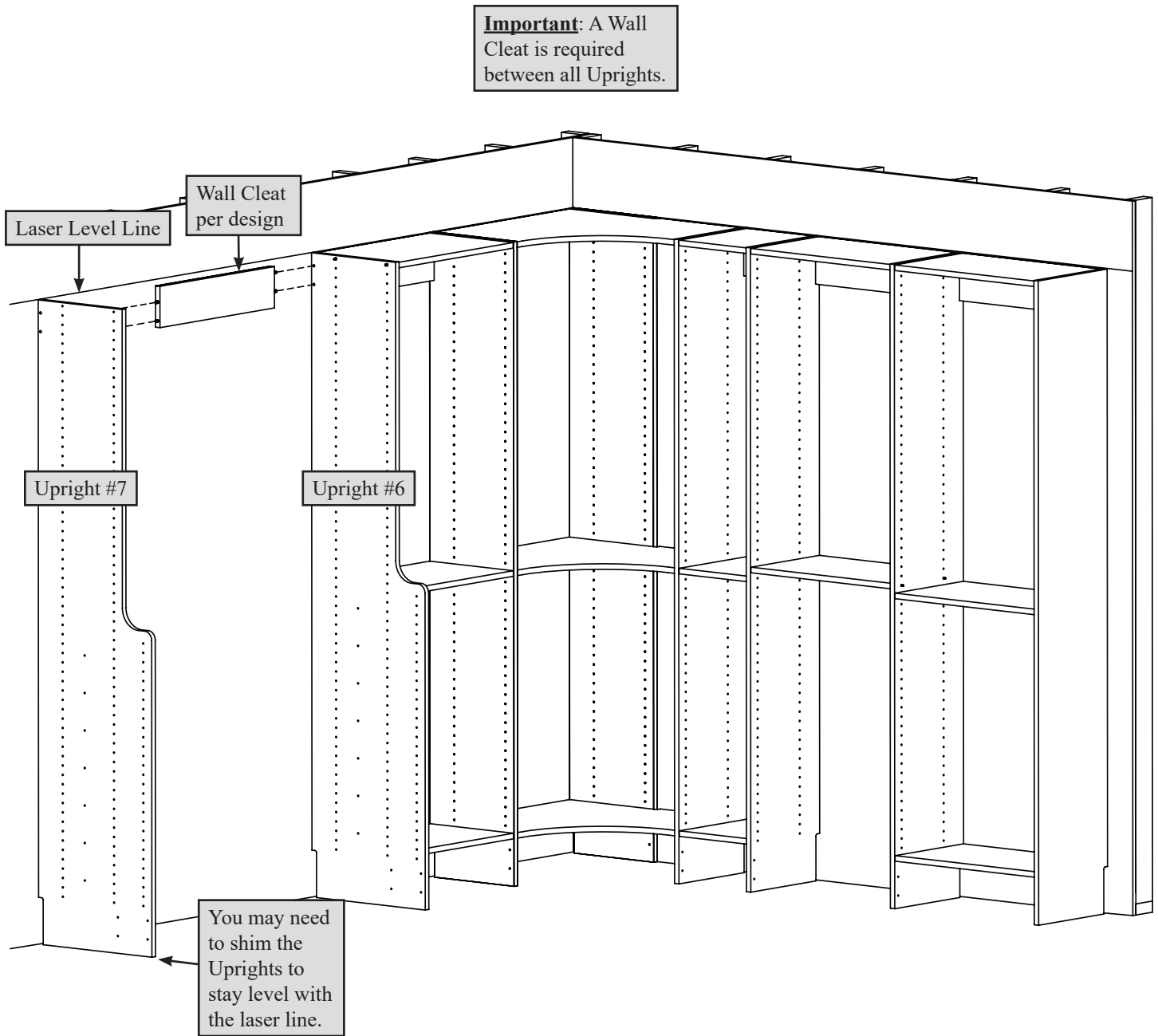

Fasten the Wall Cleat to the Uprights by pushing the wood dowels in the Wall Cleat into Uprights #6 and #7.

Important: A Wall Cleat is required between all Uprights.

Note: Wall Cleats will be anchored to the wall after all Uprights and Fixed Shelves are hung on page 34.

Floor Cabinet Installation

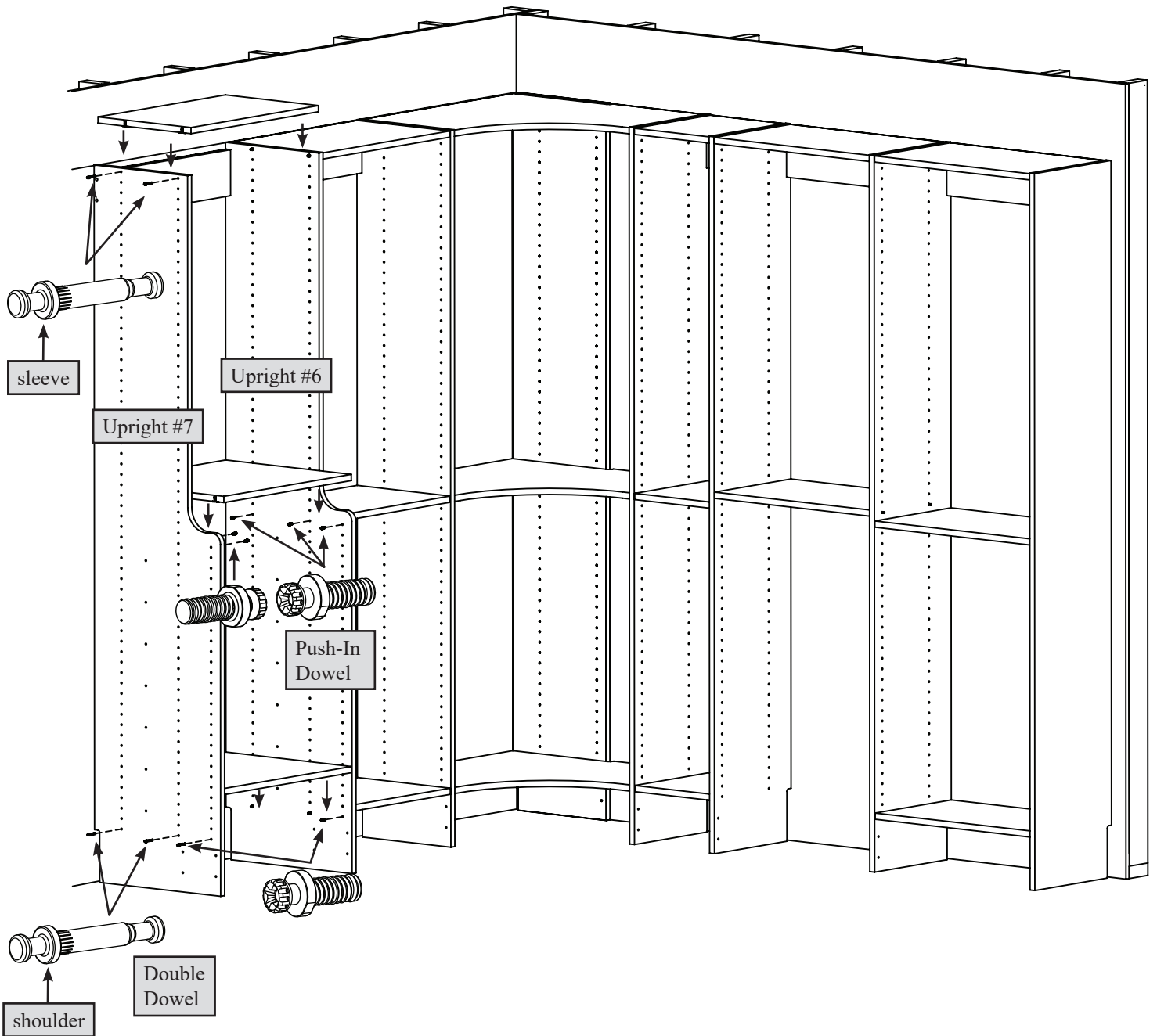

Insert four Double Dowels completely into the holes in the Upright #7.

Insert eight Push-In Dowels completely into the holes in Uprights #6 and #7.

Fasten three Fixed Shelves to Uprights #6 and #7. Tighten sixteen Connectors

Floor Cabinet Installation

Important: A Wall Cleat is required between all Uprights.

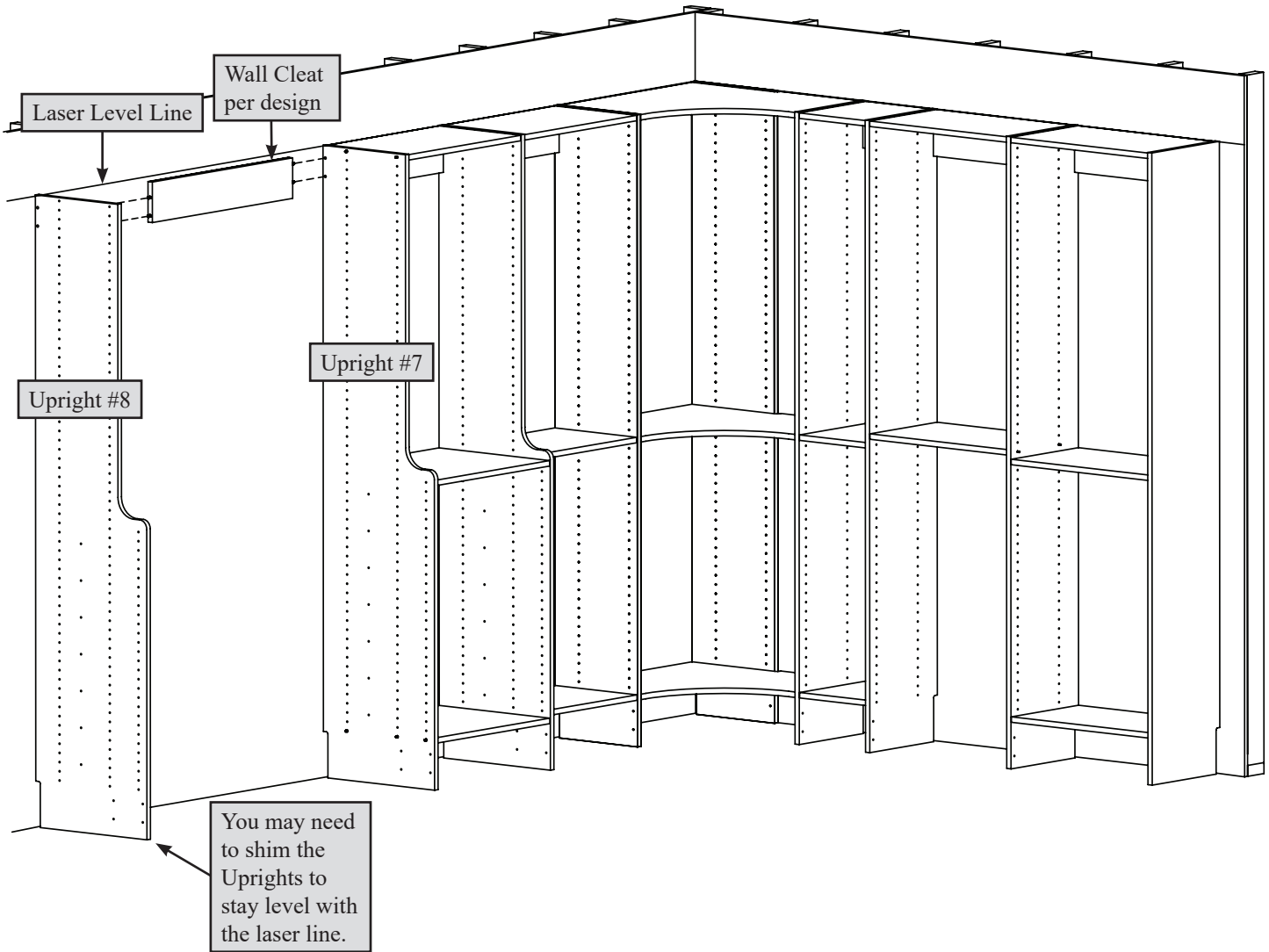

Fasten the Wall Cleat to the Uprights by pushing the wood dowels in the Wall Cleat into Uprights #7 and #8.

Important: A Wall Cleat is required between all Uprights.

Note: Wall Cleats will be anchored to the wall after all Uprights and Fixed Shelves are hung on page 34.

Floor Cabinet Installation

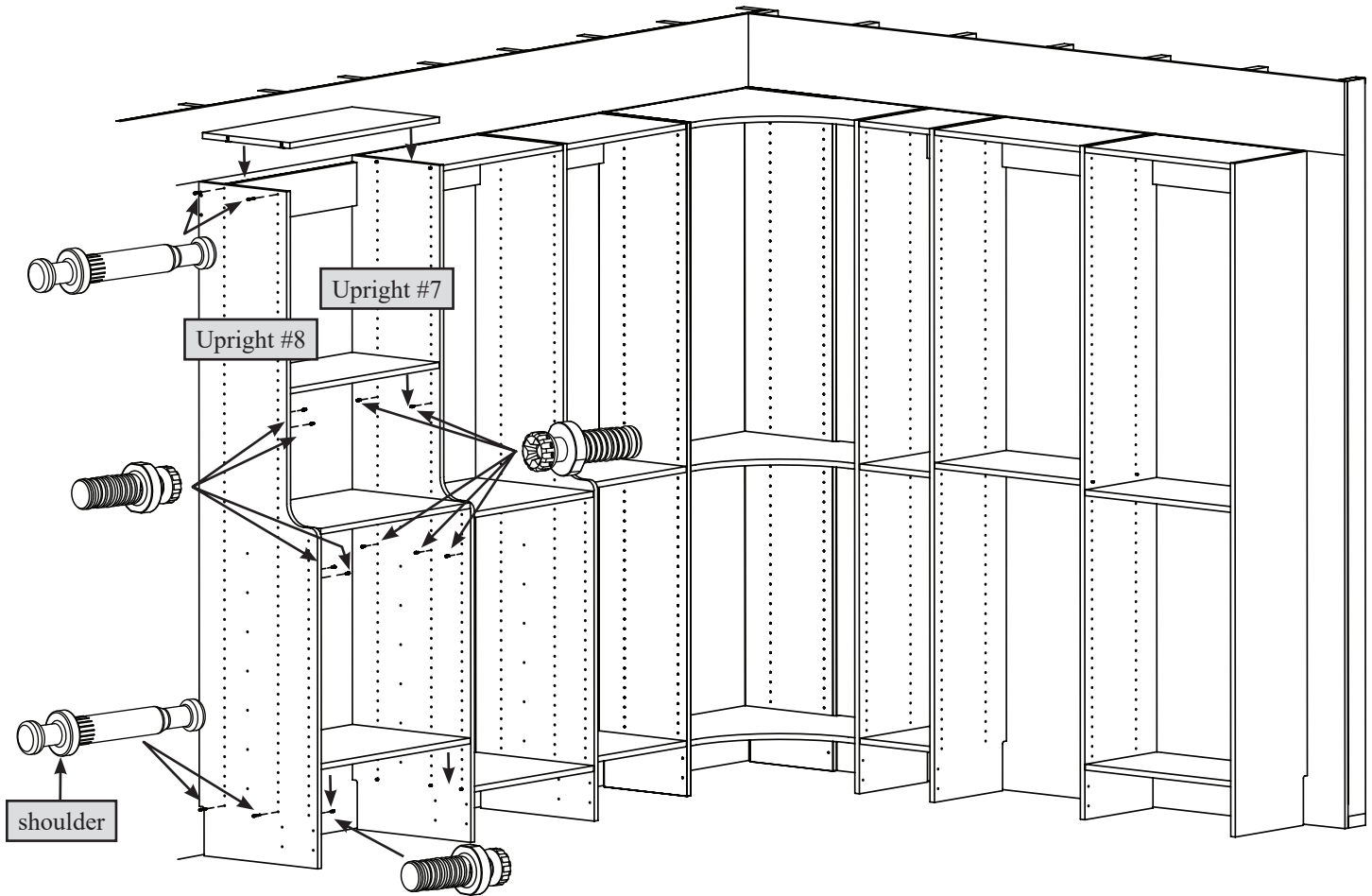

Insert four Double Dowels completely into the holes in Upright #8.

Insert eleven Push-In Dowels completely into the holes in Uprights #7 and #8.

Fasten three Fixed Shelves to Uprights #7 and #8. Tighten twenty Connectors

Floor Cabinet Installation

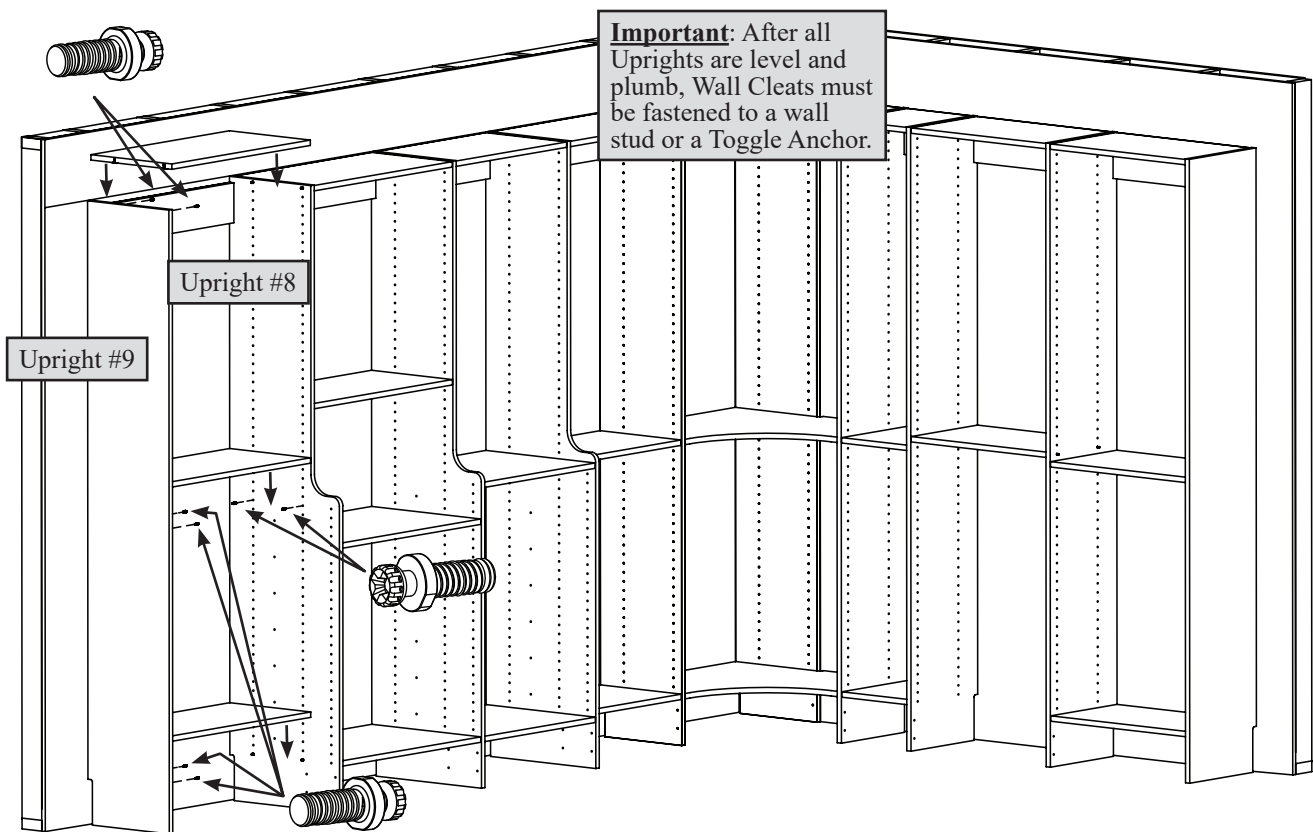
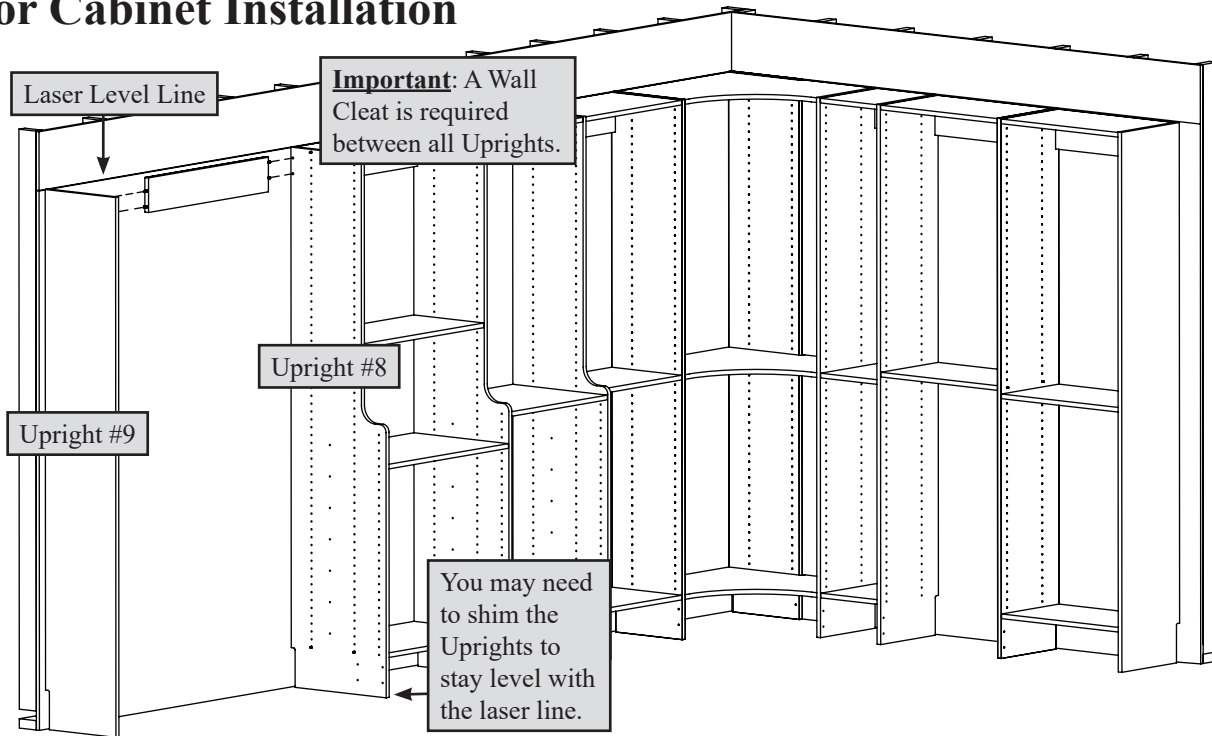

Fasten the Wall Cleat to the Uprights by pushing the wood dowels in the Wall Cleat into Uprights #8 and #9. Insert eight Push-In Dowels completely into the holes in Uprights #8 and #9.

Fasten three Fixed Shelves to Uprights #8 and #9. Tighten twelve Connectors.

IMPORTANT: After all Uprights are level and plumb, Wall Cleats must be fastened to a wall stud or a Toggle Anchor.

NOTE: To allow for Rod Cups and Rods, Push-in Dowels must be in the fourth hole up from the bottom.

To add Rods, Doors, and Drawers, refer to the applicable pages listed in the Table of Contents.

Door Installation

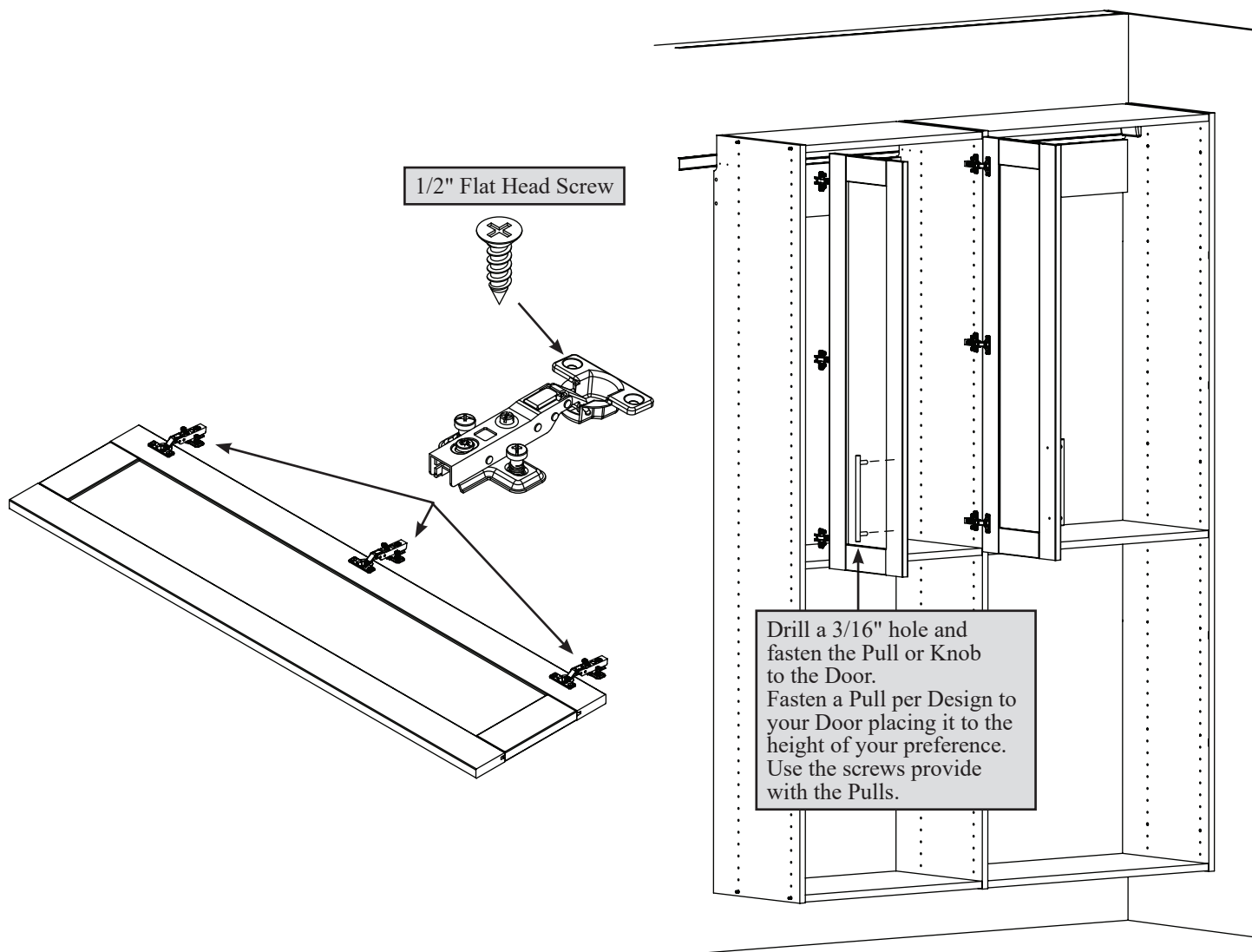

Fasten the Hinges to the Door. Use the Black 1/2" Flat Head Screws.

Fasten the Doors to the Uprights. Use the screws in the hinges.

Drill a 3/16" hole and fasten the Pull or Knob to the Door. Fasten a Pull per Design to your Door placing them to the height of your preference.

Use the screws provided with the Knob or Pull.

Drawer Installation

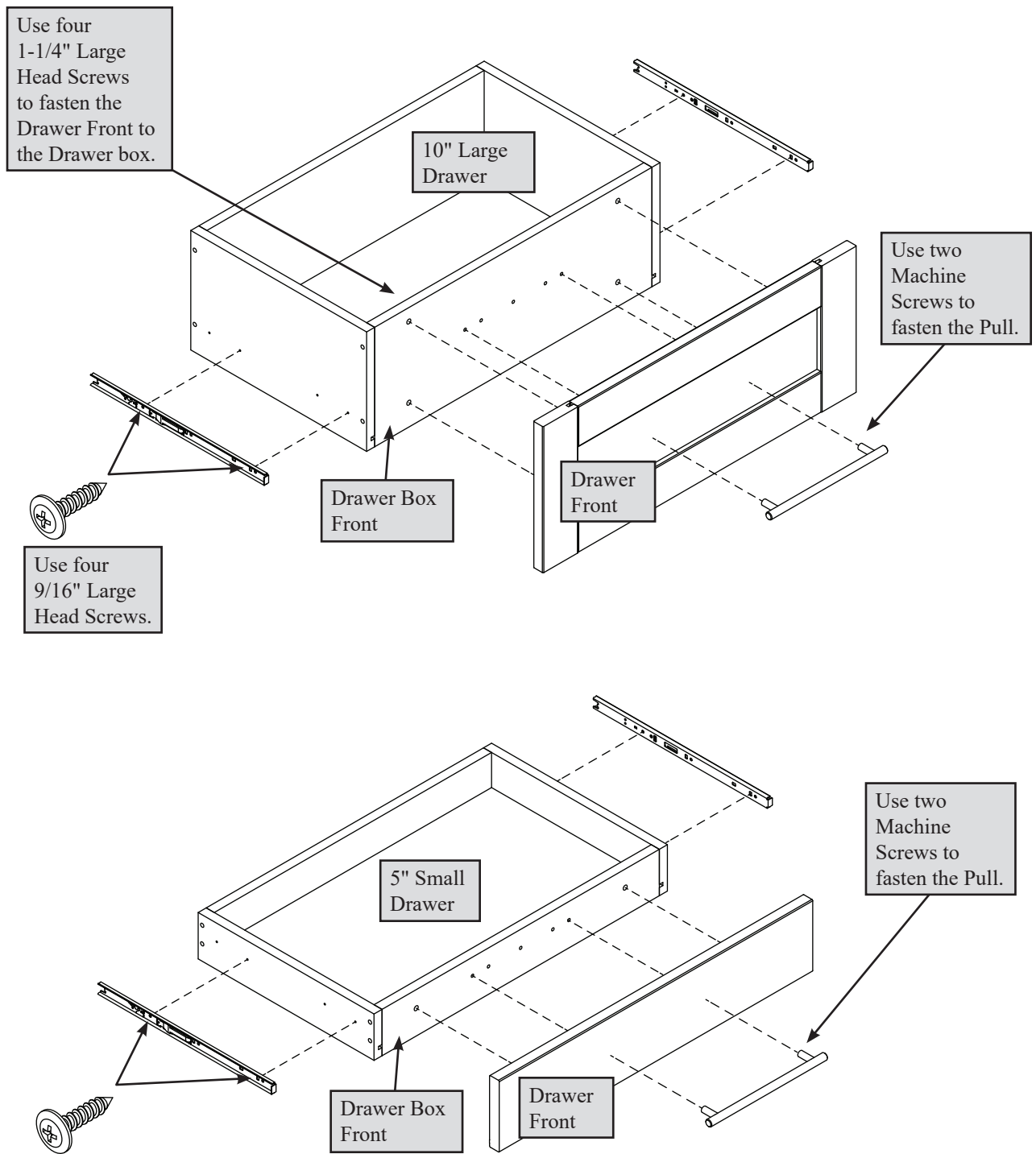

Fasten the Extension Slides to your Drawer box Sides using the 9/16" Large Head screw as shown.

NOTE: Drawer Fronts are not bored for hole placement of Pulls and Knobs. Place the Drawer front face down onto a spoil board and drill 3/16" holes in your Drawer front specific to the Pull or Knob boring.

Fasten the Drawer Front to the Drawer Front Box using the 1-1/4" Large Head Screw supplied with the drawer slide. Do not tighten the Screws at this time. Drawer fronts will be adjusted after you insert them into your cabinet.

Fasten the Pull to the Drawer Front and Drawer box front using the Machine Screws supplied with the Pull.

Drawer Installation

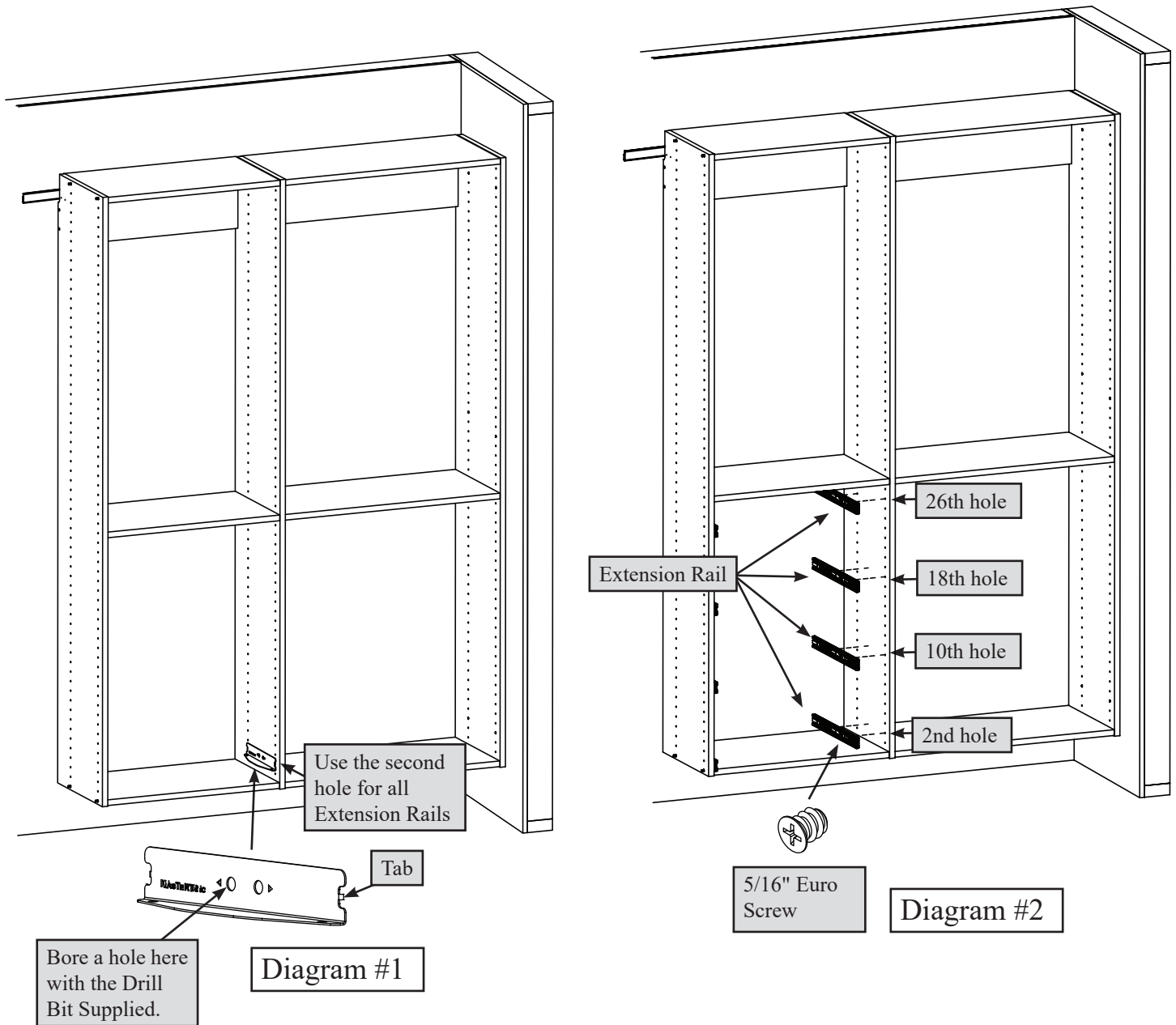

The rear hole for the 350mm Extension Rail requires boring. To do this, insert the tabs on the Rail Template Kit into the proper holes of the Upright. Use the Drill Bit supplied to drill the rear hole in the Template as shown in Diagram #1.

NOTE: The Lower Drawer Extension Rails will always use the 2nd hole up from the bottom. For 10" Large Drawers, use every 8th hole up as shown in Diagram #2. For 5" Small Drawers, use every 4th hole up. For every 10" Drawer, two 5" Drawers can be substituted.

Fasten the Extension Rails to the Upright. Use the 5/16" Flat Head Screws.

NOTE: The template is not needed if you are installing 450mm Extension Rails in your Closet Cabinets. Use the holes provided in the Uprights to fasten the 450mm Extension Rails to your Cabinet.

Shoe Shelf Installation

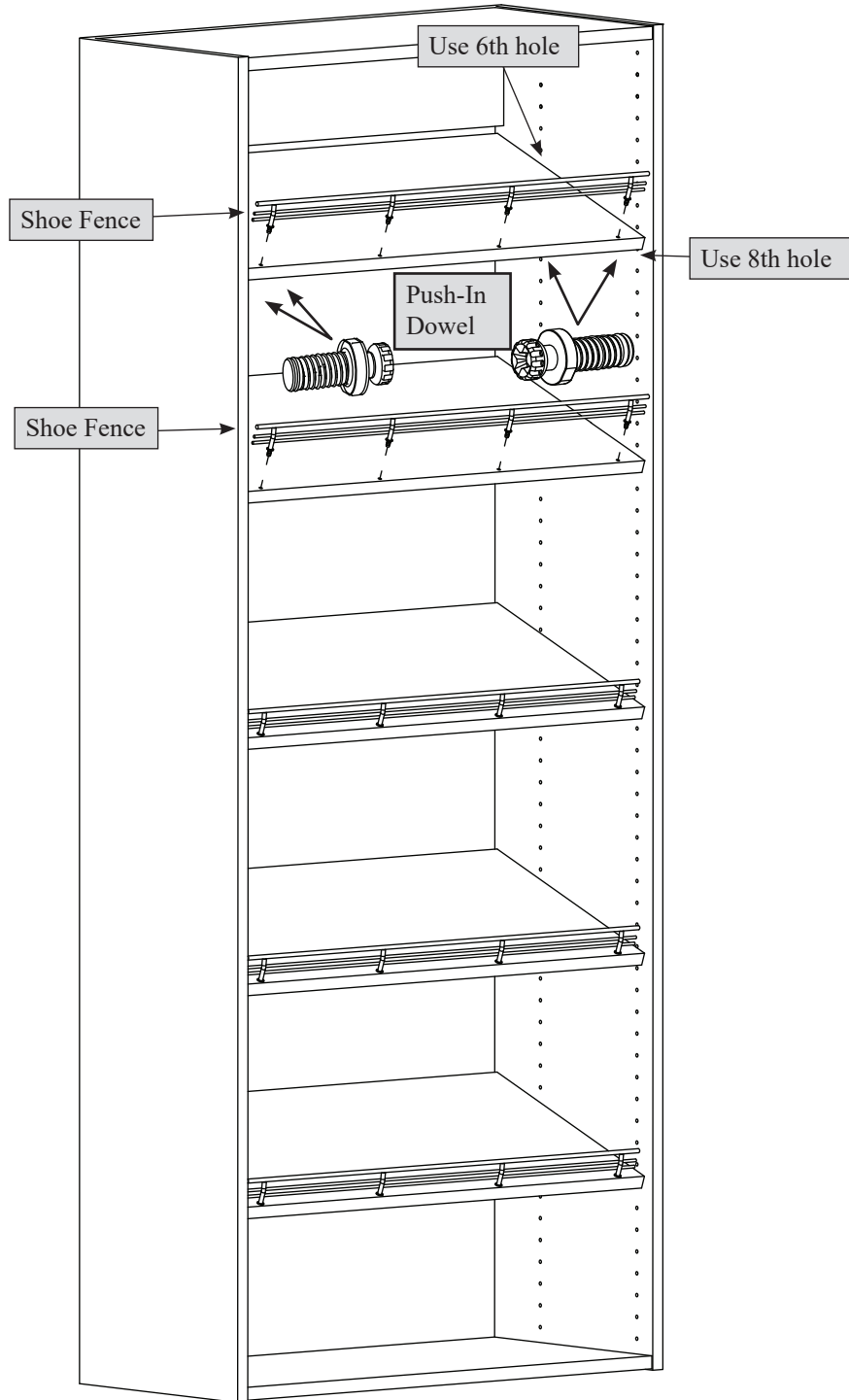

When locating a Shoe shelf in a Floor Cabinet, insert two Push-In Dowels into the 6th Upright holes below the top Fixed Shelf along the back edge.
Tighten the rear Connectors in the Shoe Shelf.

Next, insert two Push-In Dowels into the 8th Upright holes below the top Fixed Shelf along the front edge. The Shoe Shelf will rest on the front Push-In Dowels.

Then, insert the Shoe Fence into the holes along the front edge of the Shoe Shelf.

NOTE: For Shoe Shelf cabinets that hang side by side, a Double Dowel will be used to support the Shoe Shelves.

Rod Installation

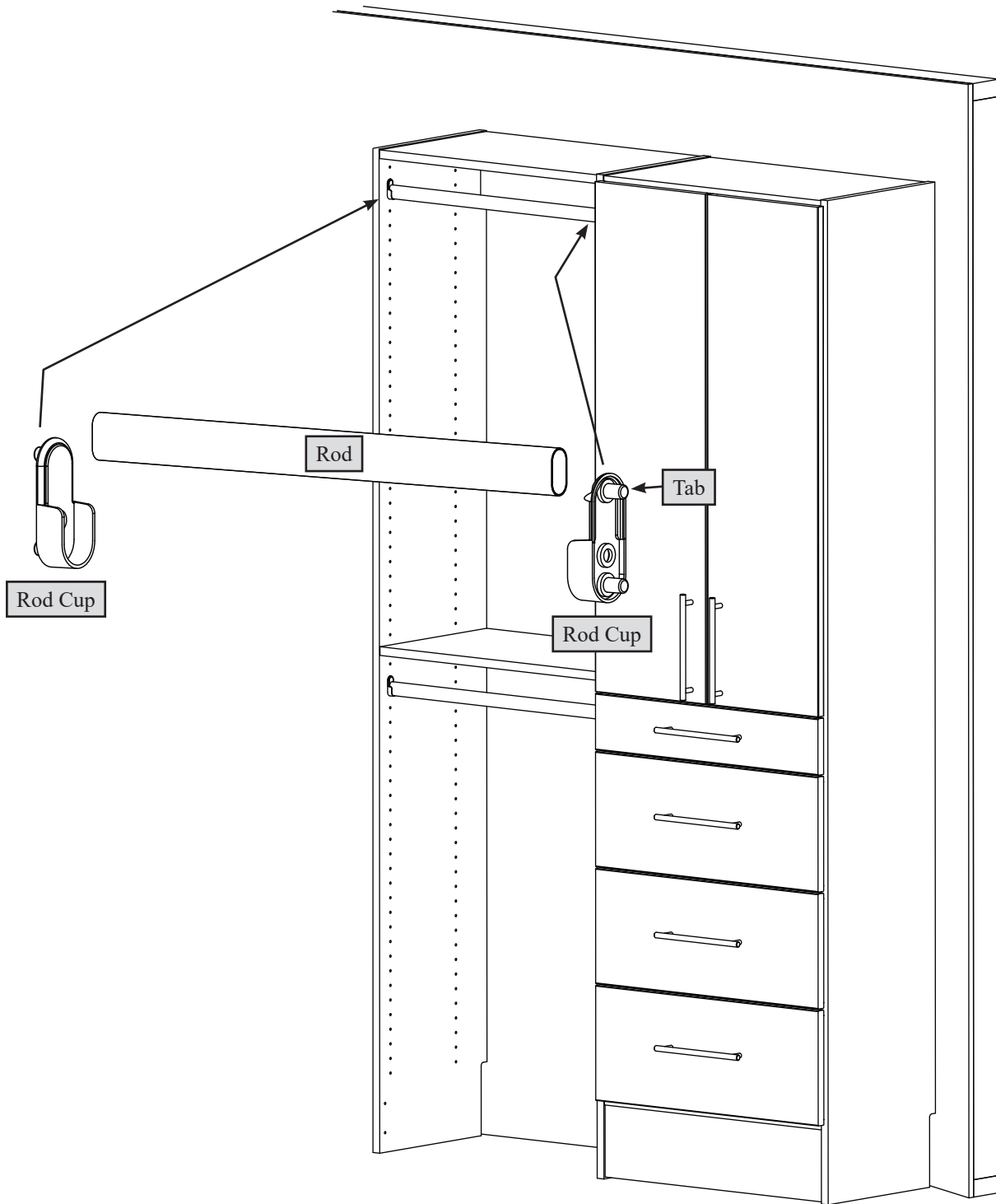

Insert the tabs of the Rod Cups into the exact holes shown.

NOTE: There should be one hole exposed above the Rod Cups.

Cut a Rod to length and place it in the Rod Cups.

Adjustable Shelf Installation

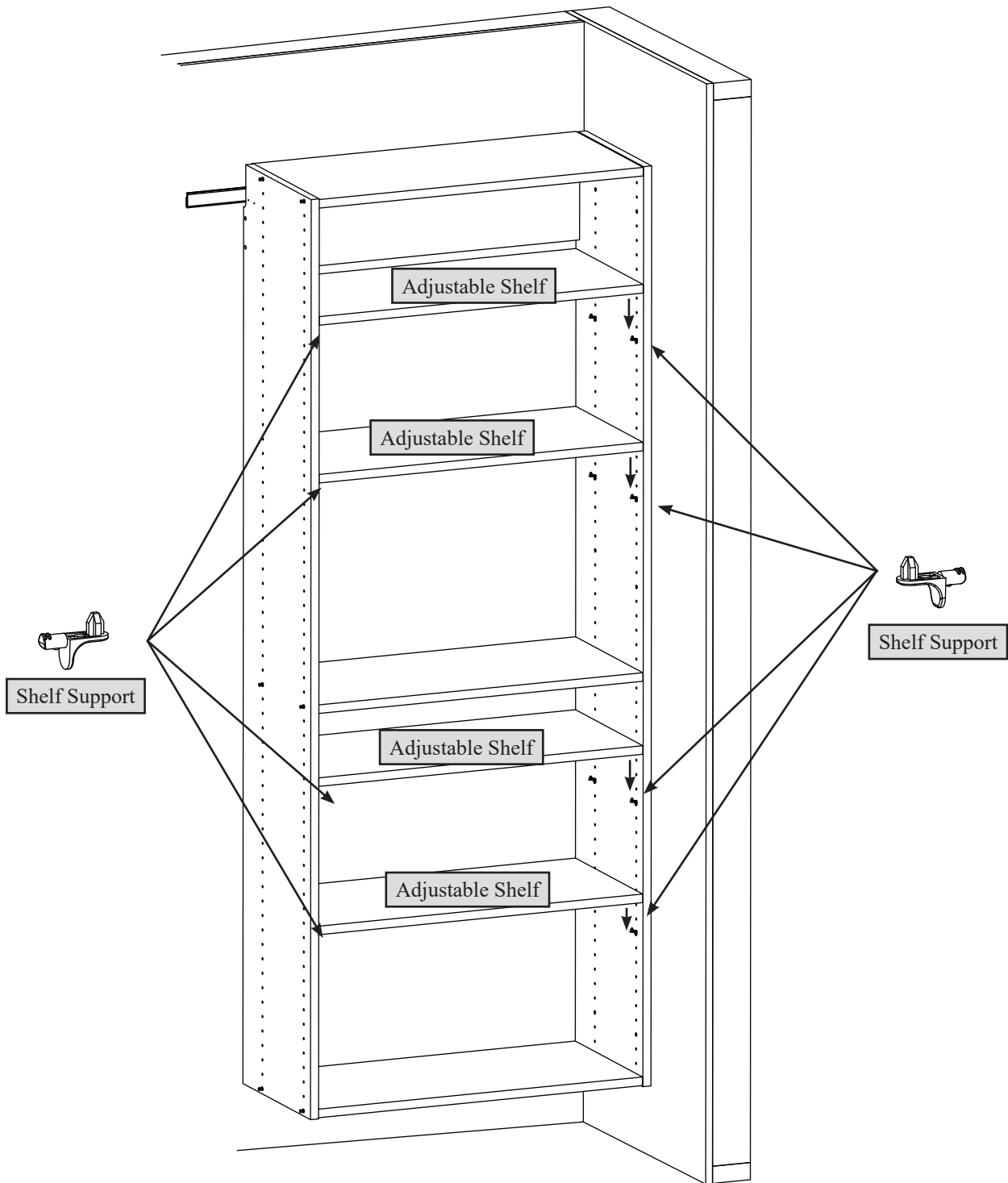

Insert the Shelf Supports into the hole locations of your choice.

Place the Adjustable Shelves onto the Shelf Supports.

H-Joint Channel Installation

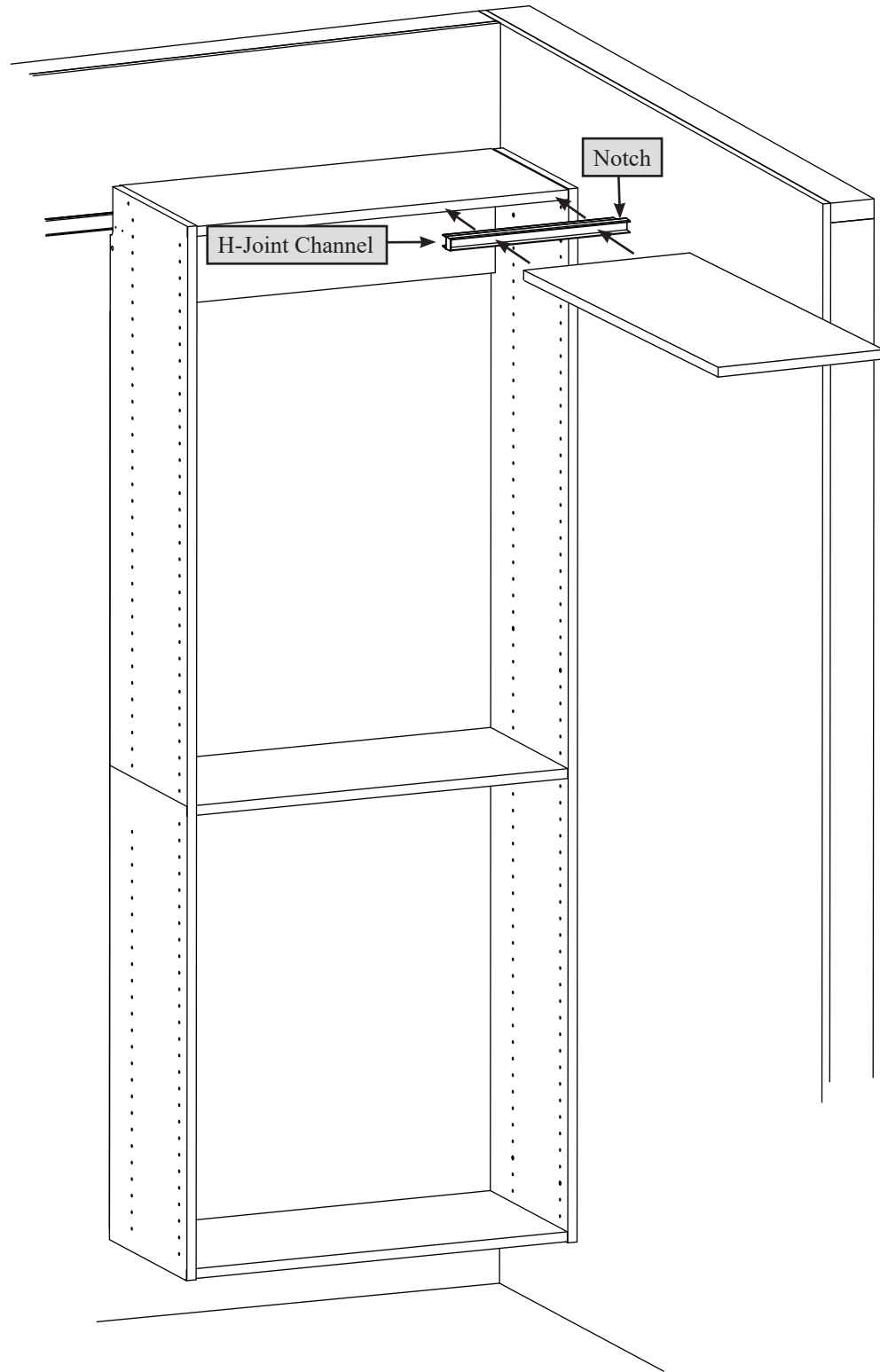

In some designs, you may have two Fixed Shelves that butt up to each other. For support between Fixed Shelves use the Corner Shelf H-Joint Channel as shown.

Cleat Dowel Boring Jig Installation

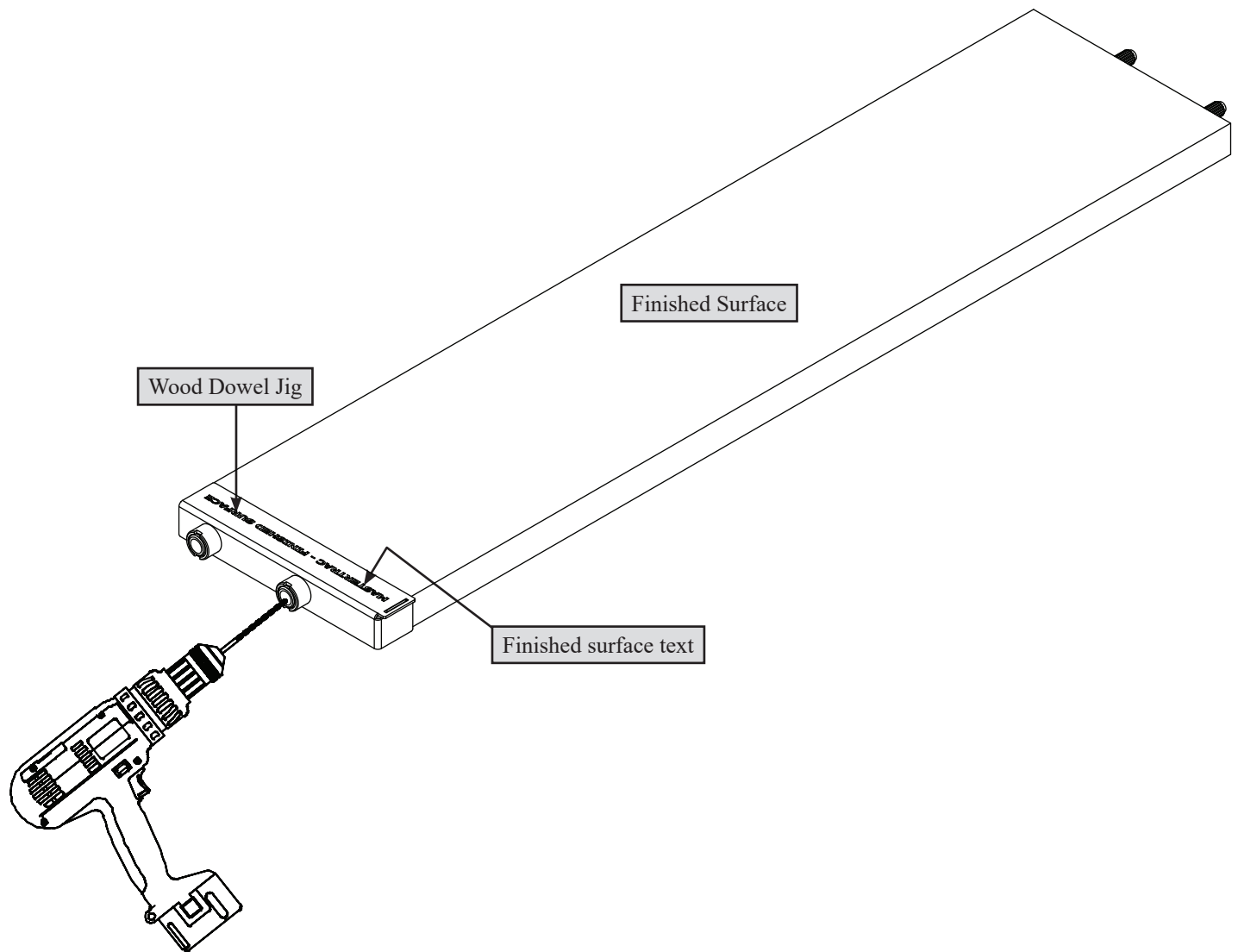

In some Designs, you may need to cut a Cleat to length and rebores holes to replace the Wood Dowels in a Cleat. Follow the diagram and steps below for instructions.

1. Cut a Cleat to length.
2. Place the template on the corner as shown with the finished surface text in the template on the finished surface of the Cleat.
3. Drill two 5/16" diameter holes 1-1/16" deep through the template holes.
4. Push two Wood Dowels into the holes.

Hole Boring and Jig Installation

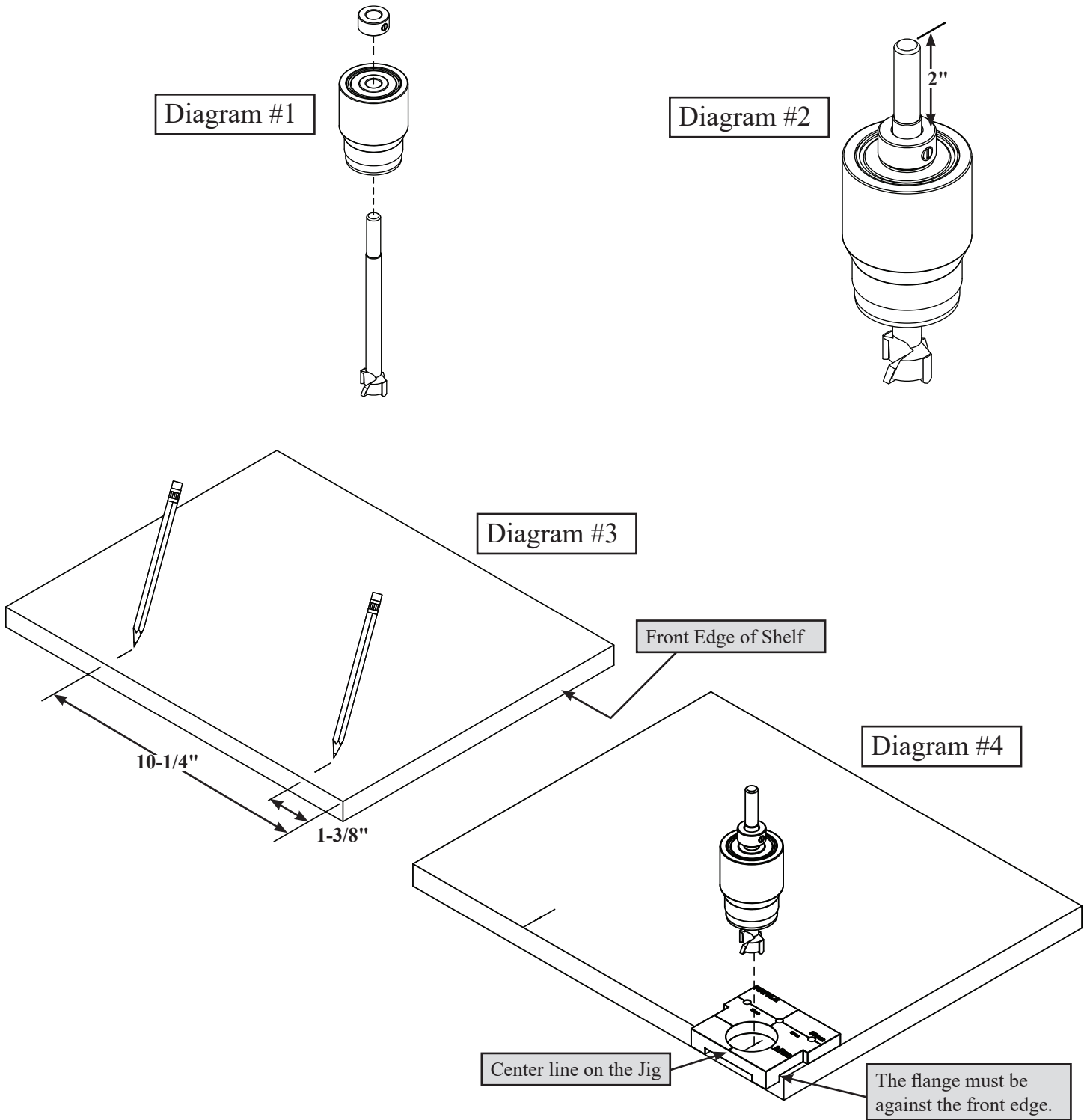

In some Designs, you may need to cut a Fixed Shelf to length and rebores holes to replace the connector holes in the Fixed Shelf. Follow the diagrams and steps below for instructions.

1. Insert the shaft of the bit through the plastic sleeve as shown in Diagram #1.
2. Place the stop over the shaft of the bit 2" from the end and tighten the set screw as shown in Diagram #2
3. Cut the Fixed Shelf to length.
4. Mark lines on the shelf as shown in Diagram #3.
5. Line up the center line on the jig with the line on the Fixed Shelf as shown in Diagram #4.
6. Drill the holes in your shelf as shown in Diagram #4.

Cam and Toe Kick Kit

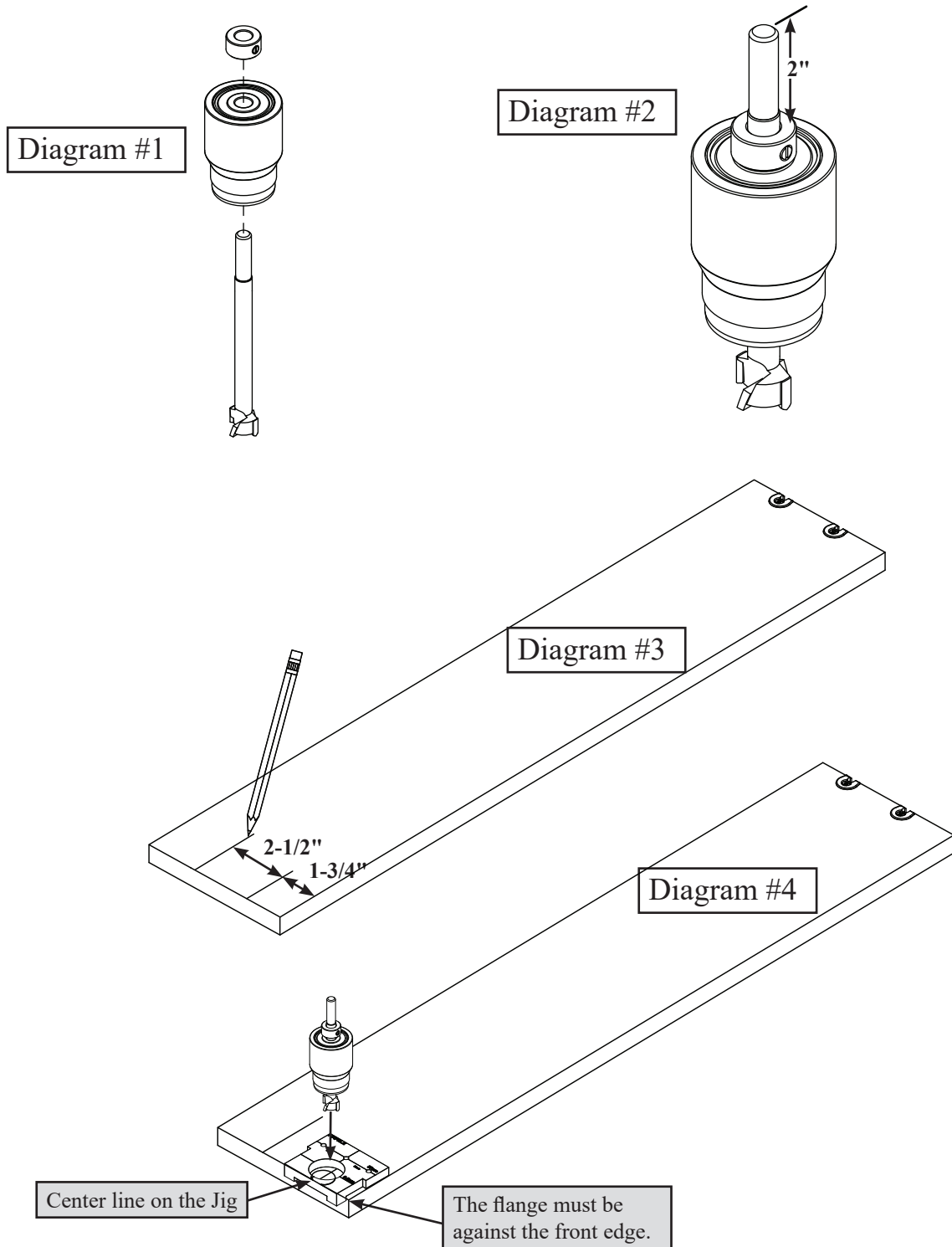

In some Designs, you may need to cut a Fixed Shelf to length and rebores holes to replace the connectors in the Shelf. Follow the diagrams and steps below for instructions.

1. Insert the shaft of the bit through the plastic sleeve as shown in Diagram #1.
2. Place the stop over the shaft of the bit 2" from the end and tighten the set screw as shown in Diagram #2
3. Cut the Toe Kick to length.
4. Mark lines on the Toe Kick as shown in Diagram #3.
5. Line up the center line on the jig with the line on your Toe Kick.
6. Drill the holes in your shelf as shown in Diagram #4.

Toe Kick Installation

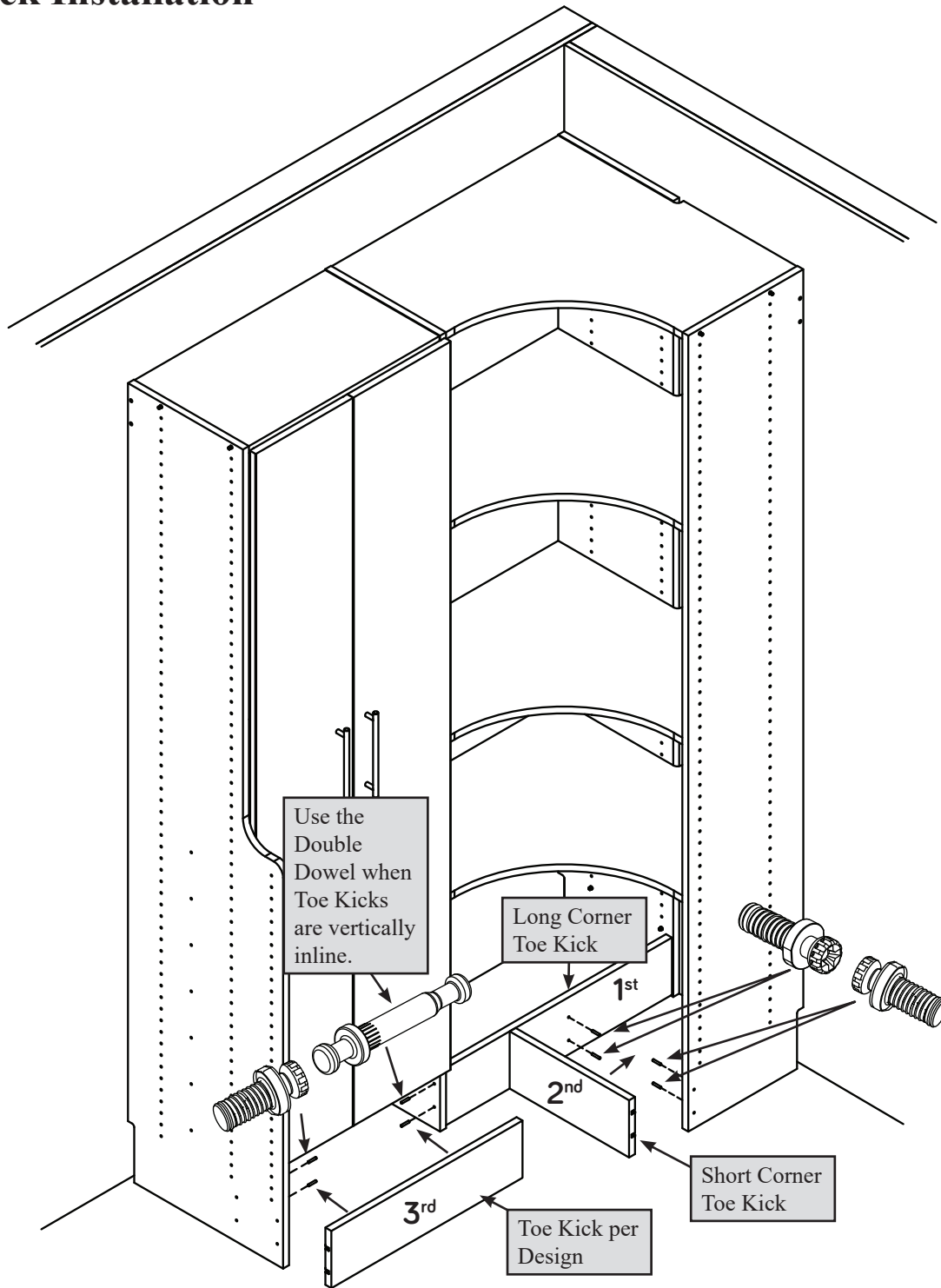

1st - Corner Floor Cabinets will require a Long Corner Toe Kick and Short Corner Toe Kick. Insert four Push-In Dowels into the right corner Upright against the wall and the left corner upright. Push the connectors in the Long Corner Toe Kick completely onto the upper Push-In Dowels. Next, rotate the Toe Kick on the upper Push-In Dowels until the connectors are exposed. Tighten two upper connectors. Rotate the Toe Kick down completely onto the lower Push-in Dowels.

NOTE: Toe Kicks that are vertically in line will use the Double Dowels in the place of the Push-In Dowels.

2nd - Insert four Push-In Dowels into the Long Corner Toe Kick and the right corner Upright. Push the upper connectors in the Short Corner Toe Kick onto the upper Push-In Dowels. Next, rotate the Toe Kick on the upper Dowels until the connectors are exposed. Tighten two upper connectors. Rotate the Toe Kick down completely onto the lower Push-in Dowels

3rd - For all other Toe Kicks, insert four Push-In Dowels or Double Dowels into the Uprights and follow the same fastening process used in steps 1 and 2.

Weight limits

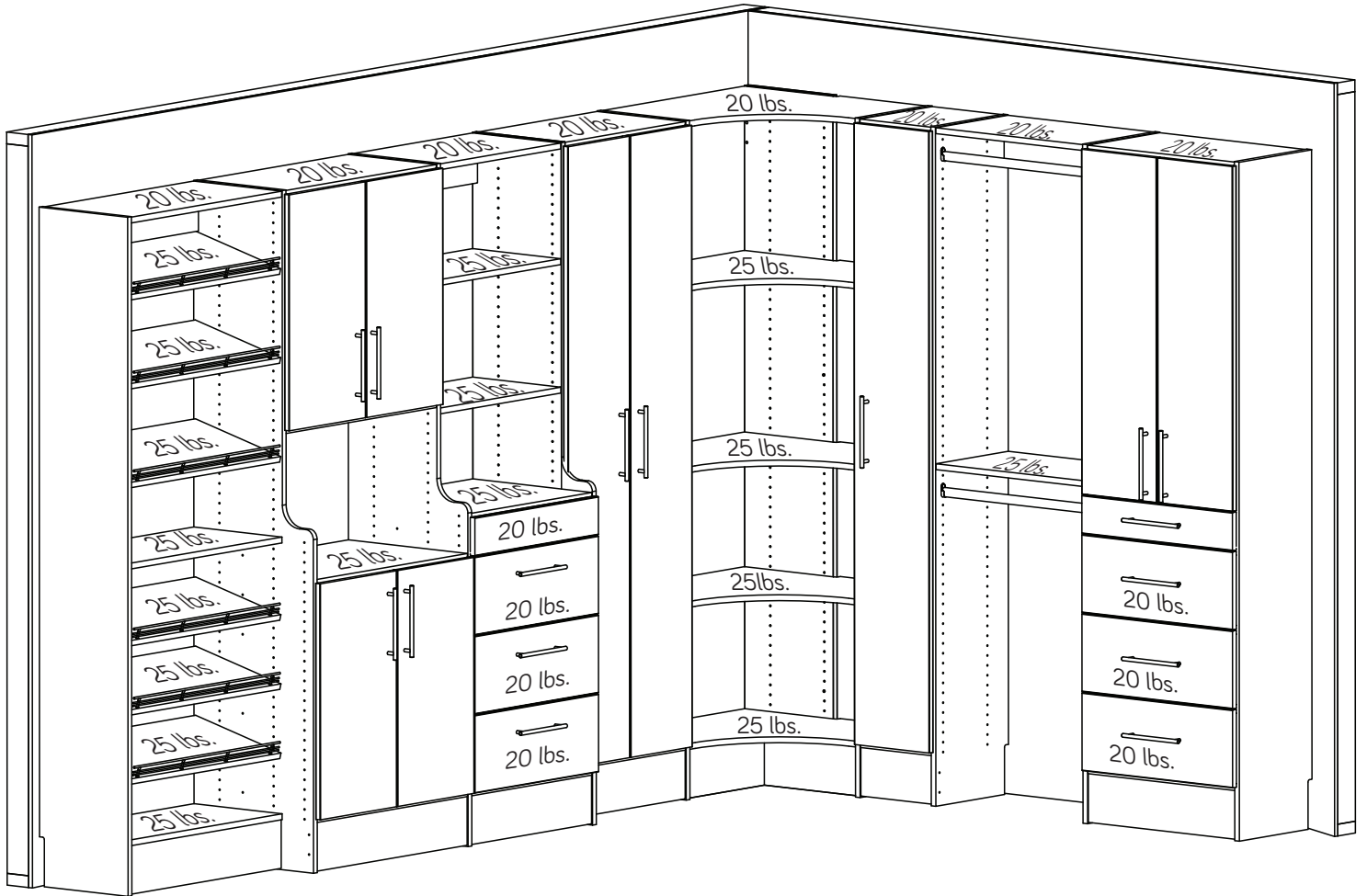

⚠ WARNING

Please use your furniture correctly and safely. Improper use can cause safety hazards, or damage to your furniture or household items. *Carefully read the following chart.*

Look out for:	What can happen:	How to avoid the problem:
<ul style="list-style-type: none"> • Loose or unstable closet components. • Tall closet component structures. • Closet component structures that are over five feet tall and placed in an open area or a walk-in closet. 	<ul style="list-style-type: none"> • Risk of injury • Closet components that are not properly connected can easily slide against each other and cause the structure to be unstable and tip over. • A tall closet structure can tip unless it is properly secured. 	<ul style="list-style-type: none"> • Closet components must be securely attached to each other from side to side, and top to bottom. • Secure the closet structure to a wall stud whenever possible. If you cannot use a wall stud, use the supplied wall anchors into your drywall. <p>(If attaching the product to a wall made of concrete, plaster, or other material, purchase and use the appropriate mounting hardware. The attachment hardware must be rated to provide a minimum of 100 pounds of pull strength.)</p>
<ul style="list-style-type: none"> • Overloaded drawers and shelves. 	<ul style="list-style-type: none"> • Risk of injury. • Top-heavy furniture can tip over. • Overloaded drawers or shelves can break. 	<ul style="list-style-type: none"> • Never exceed the weight limits shown in the instructions. • Work from bottom to top when loading shelves and drawers. Place the heavier items on the lower shelves or in lower drawers.
<ul style="list-style-type: none"> • Improper use of furniture to support TVs. • Setting TVs on furniture items not intended to support them is hazardous. 	<ul style="list-style-type: none"> • Risk of injury. • TVs can be very heavy. Plus the weight and location of the picture tube tends to make TVs unbalanced and prone to tipping forward. 	<ul style="list-style-type: none"> • This product is not designed to support a television.
<ul style="list-style-type: none"> • Children climbing or hanging on the shelves or clothing bars. 	<ul style="list-style-type: none"> • Risk of injury or death. 	<ul style="list-style-type: none"> • Do not allow children to climb or hang on the shelves or clothing bars. Avoid placing items like toys or candy on shelves.

WOODTRAC® CLOSET PRODUCTS LIMITED WARRANTY

WoodTrac® by Sauder provides limited lifetime warranty coverage on WoodTrac® Closet Products (the "Products") to the original first use retail consumer ("Consumer") as set forth in this limited warranty statement. This limited warranty gives you specific legal rights, and you may also have other rights which vary from state to state.

Limited Lifetime Warranty Coverage: WoodTrac® warrants that the Products will be free from defects in material and workmanship under conditions of normal, residential use, for the lifetime of the Products. This limited warranty extends only to the original, first-use retail Consumer, and is not transferable.

Limitations on Warranty Coverage: WoodTrac's® Limited Lifetime Warranty (described above) is the only warranty coverage provided by WoodTrac® for the Products, and is in lieu of all other warranties. Under the laws of certain states, there may be no implied warranties from WoodTrac®, and ALL IMPLIED WARRANTIES, INCLUDING ANY IMPLIED WARRANTY OF MERCHANTABILITY OR FITNESS FOR A PARTICULAR PURPOSE ARE DISCLAIMED AND EXCLUDED TO THE FULLEST EXTENT ALLOWED BY LAW.

Exclusions from Coverage: This limited warranty does not cover defects arising from (1) the improper installation or use of the Products; (2) abuse or neglect; (3) any commercial, rental or non-residential use of the Products (including the installation and use of the Products in a commercial or rental structure); or (4) normal wear and tear.

Exclusive Remedy: WoodTrac® will (at its option) repair or replace any defective Products (or components) at no charge, subject to confirmation of the defect and proof of purchase, as the sole and exclusive remedy under this limited warranty. This limited warranty does not cover costs for installation, returning any defective Products to WoodTrac®, for removal or other labor costs in connection with the repair or replacement of the Products, all of which shall be the responsibility of the Consumer. WoodTrac's® liability under this limited warranty shall not exceed the purchase price of the Products. WoodTrac® shall have NO LIABILITY FOR ANY INCIDENTAL OR CONSEQUENTIAL DAMAGES OF ANY KIND, and all such claims and damages are DISCLAIMED AND EXCLUDED FROM THIS LIMITED WARRANTY. You must notify WoodTrac®, in writing, within 90 days after discovering any defect in order to receive limited warranty coverage.

Some states do not allow limitations on how long an implied warranty lasts, or the exclusion or limitation of incidental or consequential damages, so the above limitations may not apply to you.

To Obtain Warranty Service or Information: For warranty inquiries or claims, contact WoodTrac® at 1-855-854-7465, 502 Middle Street, Archbold, OH (USA) 43502, woodtrac@sauder.com. Return of any defective Product may be required by WoodTrac®, or we may elect to examine the product at its location. If we ask you to ship any Products to us, we will issue you a return authorization number and provide return instructions. For returned Products to qualify for limited warranty coverage, they must be returned in the original or equivalent packaging, in accordance with the shipping instructions you receive from us, and must prominently display the return authorization number on the return package.

Stay Connected
with **WOODTRAC**
by sauder



WOODTRAC
closets by sauder

Trust Sauder

Sauder has been making wood products since 1934. Today we offer a wide range of products, mostly made right here in Archbold, Ohio, and supported by our award-winning customer service.

WoodTrac® Closets by Sauder are supported by our Limited Lifetime Warranty and offers the same made-in-the-USA advantages as the rest of our product line.

Certificate of Conformity

1. This certificate applies to the Sauder Woodworking Product identified by this Instruction Book.
2. This certificate applies to compliance of this product with the CPSC Ban on Lead-Containing Paint (16 CFR 1303).
3. This product is manufactured by:
Sauder Woodworking Company
502 Middle Street
Archbold, Ohio 43502
(419) 446-2711
4. Date of Manufacture: _____



**register your new
product online**

For immediate service, our website is available 24 hours a day, 7 days a week to order replacement parts, register your product, and view Woodtrac products. **www.woodtrac.com**

Consumer Services in United States and Canada
Mon.-Fri. – 9am-5:30pm ET(except holidays)
1-855-854-7465