

Cleat and Shelf Installation

422452 - 422617 - 422618 96" Back Cleat

422619 - 422620 - 422621 12" Side Cleat

422635 - 422636 - 422637 15-1/2" Side Cleat

418849 - 418851 - 419691 12" X 96" Shelf

419353 - 419354 - 419692 15-1/2" X 96" Shelf

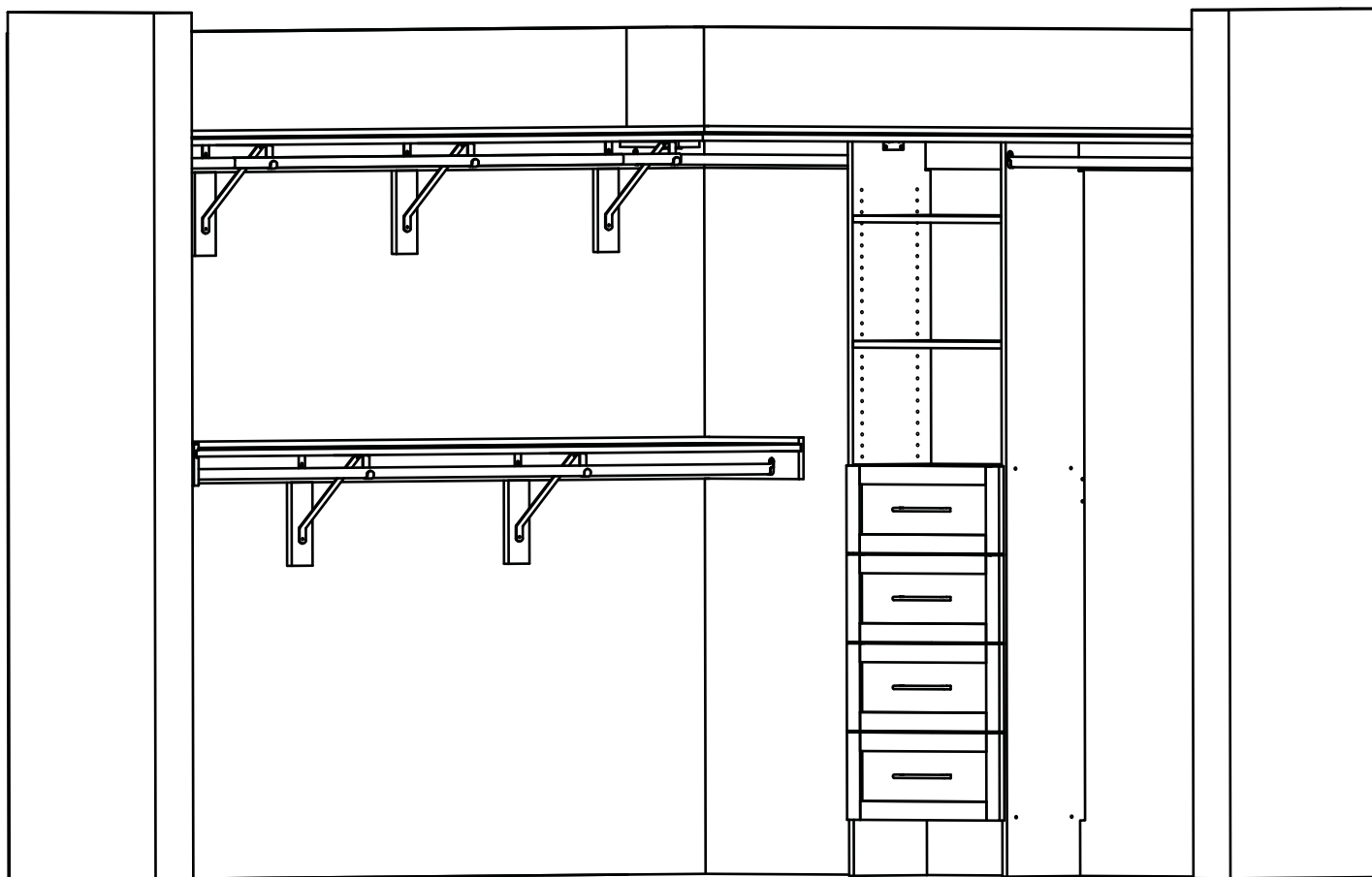

Call us at **1-855-854-7465**

or visit us at

www.woodtrac.com

NOTE: THIS INSTRUCTION BOOKLET CONTAINS **IMPORTANT** SAFETY INFORMATION.

PLEASE READ AND KEEP FOR FUTURE REFERENCE.



Made in USA

with U.S. and imported materials

Lot #: 506433

01 / 19 / 18

Purchased: _____

Closet Shelving Components Overview

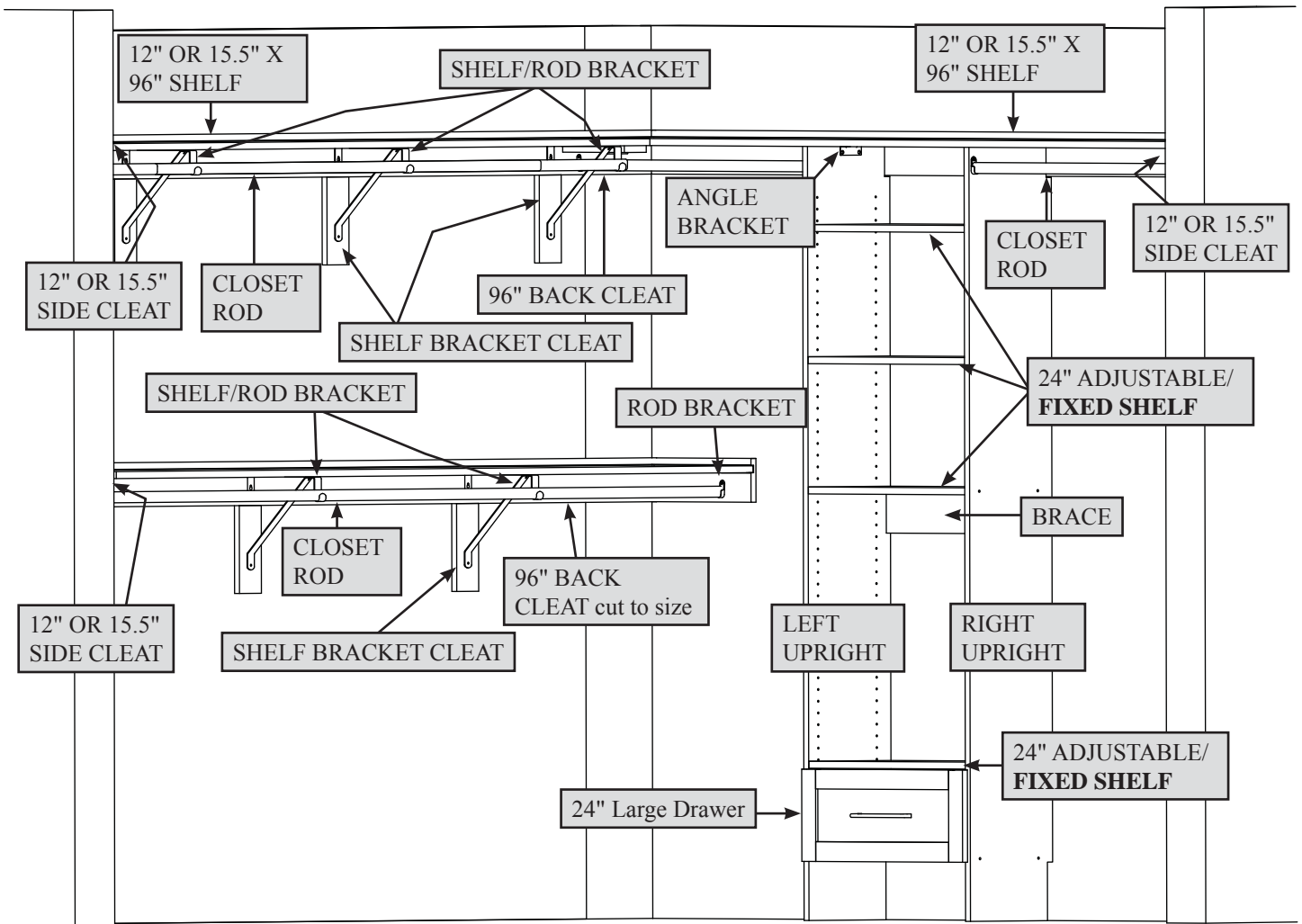

DRYWALL ANCHOR

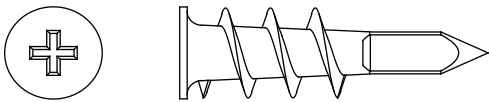

ANGLE BRACKET

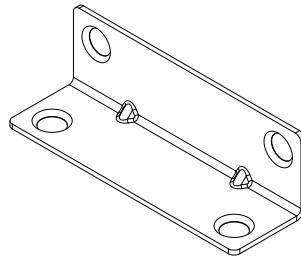

APPLIQUE CARD

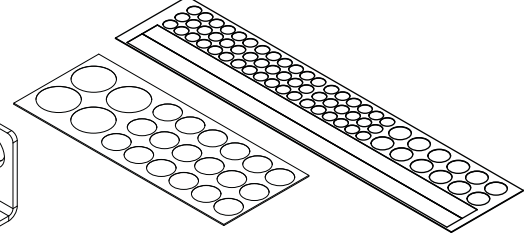

ROD BRACKET



METAL PIN

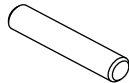

BLACK 2-3/4" FLAT HEAD SCREW (BACK CLEAT to wall)

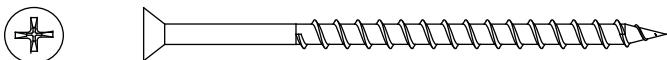

BLACK 1-15/16" FLAT HEAD SCREW (UPRIGHTS to BRACE and SHELVES)

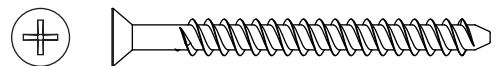

SILVER 3/4" SELF DRILLING (ROD to ROD BRACKET)



SILVER 3/4" FLAT HEAD SCREW (ROD BRACKET to UPRIGHT and CLEATS)



BLACK 9/16" LARGE HEAD SCREW (ANGLE BRACKET to an UPRIGHT, SHELF and SIDE CLEAT)

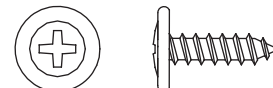

Screws are shown actual size. You may receive extra hardware with your unit.

Step
1

DRYWALL ANCHOR

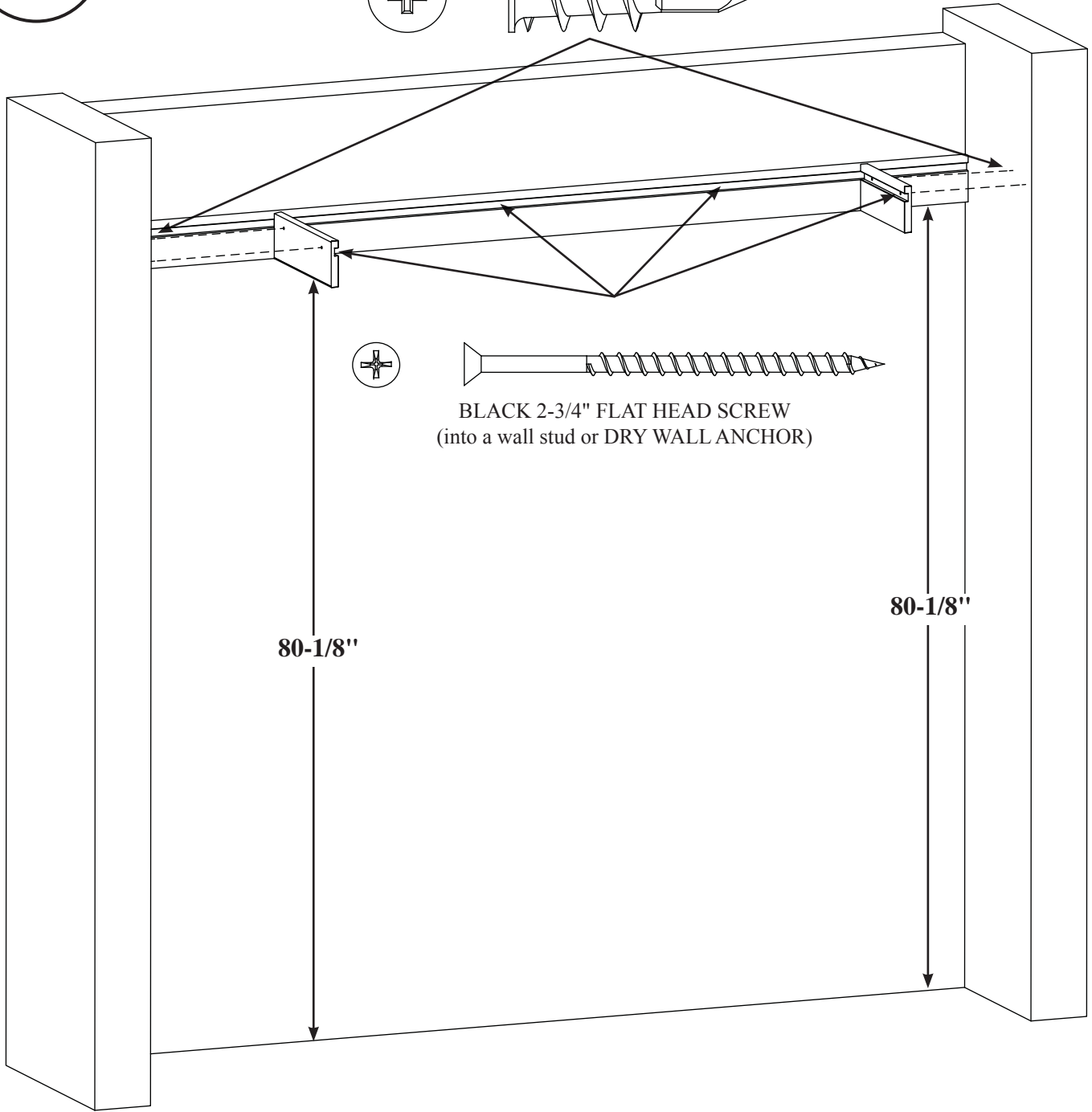
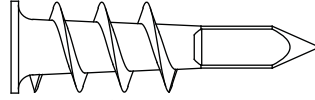

BLACK 2-3/4" FLAT HEAD SCREW
(into a wall stud or DRY WALL ANCHOR)

Cut to size a 96" BACK CLEAT and fasten it to the back wall 80-1/8" from the floor using a BLACK 2-3/4" FLAT HEAD SCREW through the groove of the BACK CLEAT and into all wall studs or a DRY WALL ANCHOR.

NOTE: Screws into wall studs must be 16" apart. If using DRY WALL ANCHORS only, they must be 12" apart.

Use DRY WALL ANCHORS and BLACK 2-3/4" FLAT HEAD SCREWS to fasten SIDE CLEATS to the wall.

Step
2

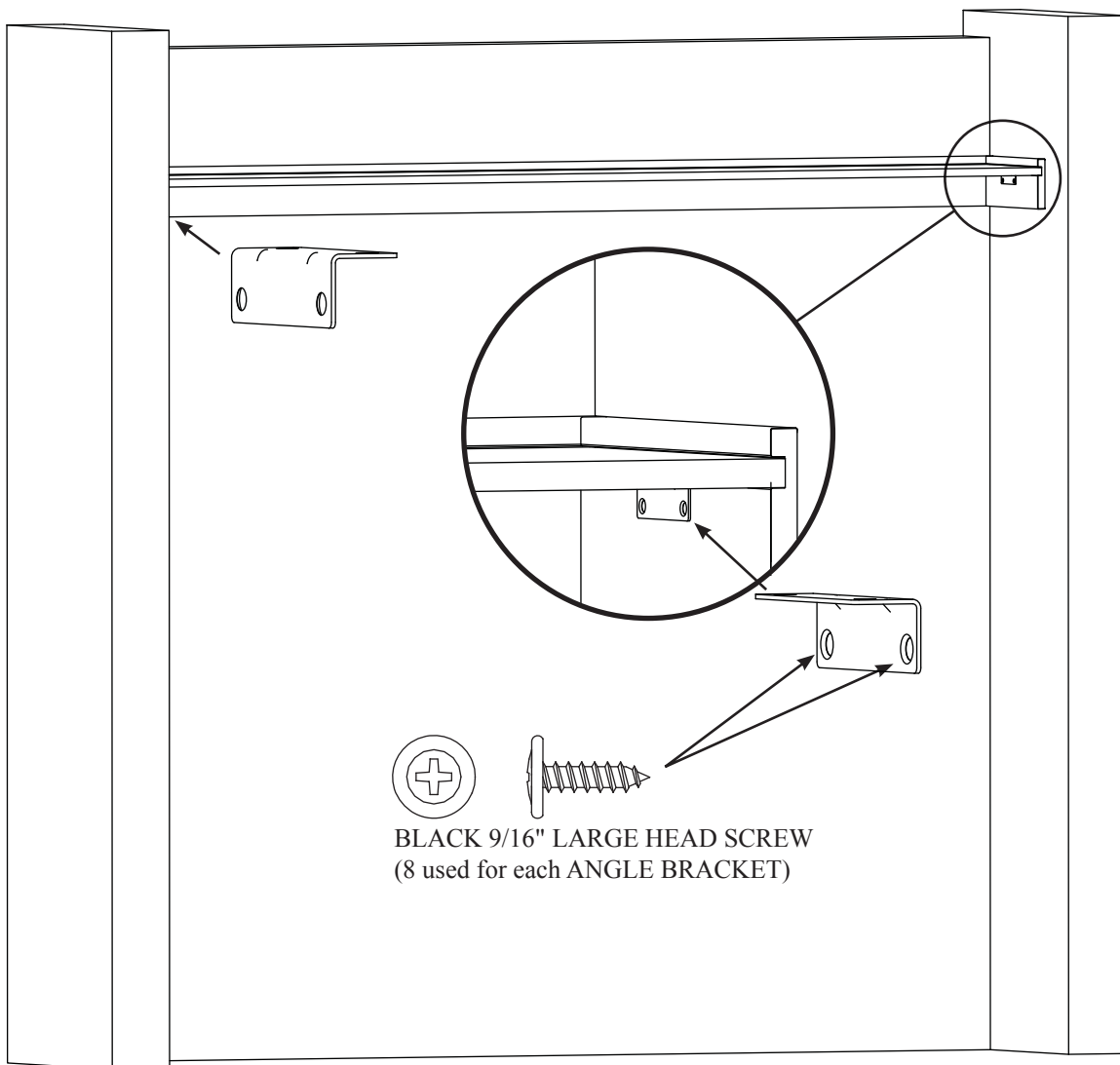
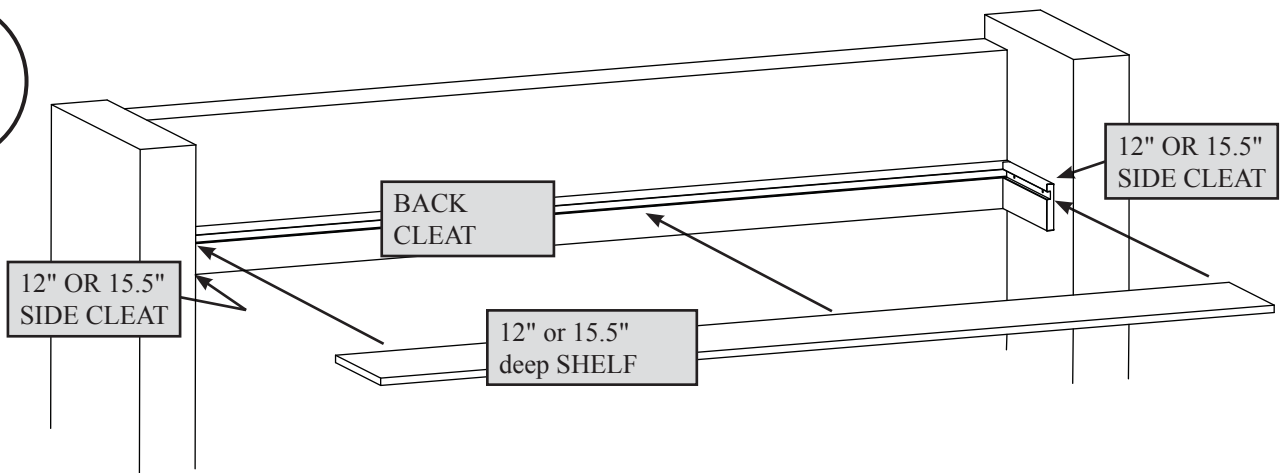

Cut to size a 96" SHELF and slide it into the grooves of the SIDE CLEATS and BACK CLEAT as shown in the upper diagram.

Fasten the SHELF to the SIDE CLEATS with two ANGLE BRACKETS and eight BLACK 9/16" LARGE HEAD SCREWS.

NOTE: If you are installing a closet rod, install Rod Support Brackets using the Rod Support Side Bracket Template, before installing ANGLE BRACKETS.

NOTE: If you purchased the Upright Pack and Adjustable Shelf/Brace Pack and/or the 24" Large Drawer Kit, see those Instruction booklets on how to install those components.

Step 3

RECOMMENDED MAXIMUM LOAD:

Installation into wall studs offers a recommended maximum weight capacity of 625 lbs or 78.125 lbs per foot.

Installation into drywall anchors offers a recommended maximum weight capacity of 625 lbs or 78.125 lbs per foot.

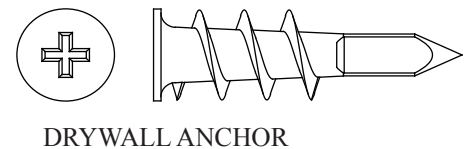
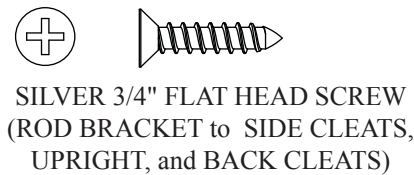
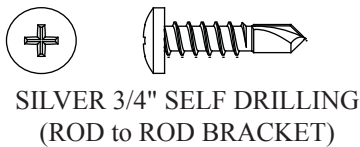
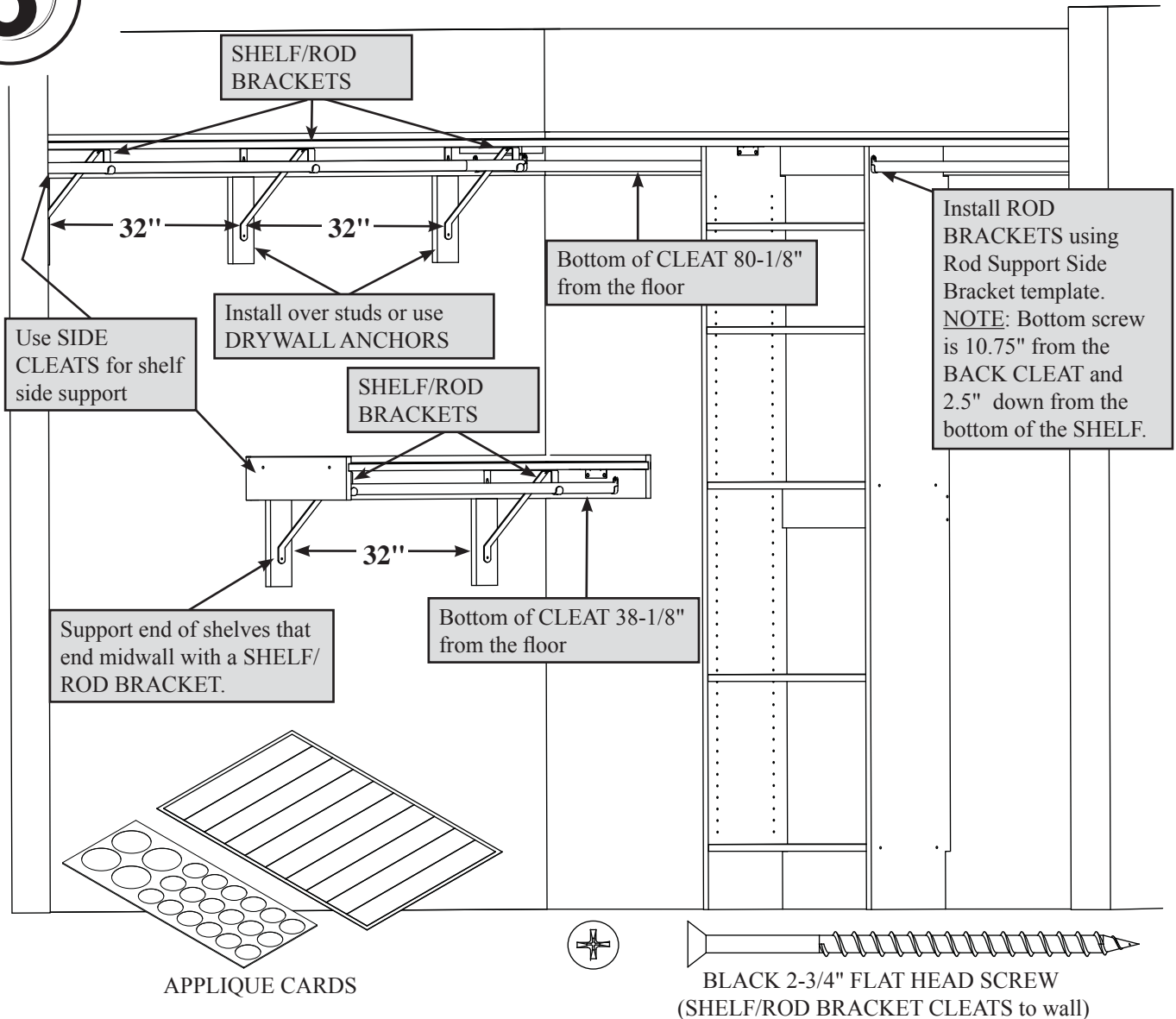

Fasten SHELF/ROD BRACKET CLEATS over the wall studs using a BLACK 2-3/4" FLAT HEAD SCREW and a DRYWALL ANCHOR if necessary.

Fasten SHELF/ROD BRACKETS with the SILVER 3/4" FLAT HEAD SCREWS ensuring that the SHELF is level.

Fasten ROD BRACKETS on SIDE CLEATS, UPRIGHTS or BACK CLEATS using the SILVER 3/4" FLAT HEAD SCREWS.

Fasten CLOSET RODS securing them with SILVER 3/4" SELF DRILLING SCREWS through SHELF/ROD BRACKETS.

Peel appliques from the APPLIQUE CARDS to cover screws and edges of SIDE CLEATS.

NOTE: Please read the back pages of the instruction booklet for important safety information.

This completes assembly. Clean with your favorite furniture polish or a damp cloth. Wipe dry.

WARNING

Please use your furniture correctly and safely. Improper use can cause safety hazards, or damage to your furniture or household items. *Carefully read the following chart.*

Look out for:	What can happen:	How to avoid the problem:
<ul style="list-style-type: none"> • Loose or unstable closet components. • Tall closet component structures. • Closet component structures that are over five feet tall and placed in an open area or a walk-in closet. 	<ul style="list-style-type: none"> • Risk of injury • Closet components that are not properly connected can easily slide against each other and cause the structure to be unstable and tip over. • A tall closet structure can tip unless it is properly secured. 	<ul style="list-style-type: none"> • Closet components must be securely attached to each other from side to side, and top to bottom. • Secure the closet structure to a wall stud whenever possible. If you cannot use a wall stud, use the supplied wall anchors into your drywall. <p>(If attaching the product to a wall made of concrete, plaster, or other material, purchase and use the appropriate mounting hardware. The attachment hardware must be rated to provide a minimum of 50 pounds of pull strength.)</p>
<ul style="list-style-type: none"> • Overloaded drawers and shelves. 	<ul style="list-style-type: none"> • Risk of injury. • Top-heavy furniture can tip over. • Overloaded drawers or shelves can break. 	<ul style="list-style-type: none"> • Never exceed the weight limits shown in the instructions. • Work from bottom to top when loading shelves and drawers. Place the heavier items on the lower shelves or in lower drawers.
<ul style="list-style-type: none"> • Improper use of furniture to support TVs. • Setting TVs on furniture items not intended to support them is hazardous. 	<ul style="list-style-type: none"> • Risk of injury. • TVs can be very heavy. Plus the weight and location of the picture tube tends to make TVs unbalanced and prone to tipping forward. 	<ul style="list-style-type: none"> • This product is not designed to support a television.

WOODTRAC® CLOSET PRODUCTS LIMITED WARRANTY

WoodTrac® by Sauder provides limited lifetime warranty coverage on WoodTrac® Closet Products (the "Products") to the original first use retail consumer ("Consumer") as set forth in this limited warranty statement. This limited warranty gives you specific legal rights, and you may also have other rights which vary from state to state.

Limited Lifetime Warranty Coverage: WoodTrac® warrants that the Products will be free from defects in material and workmanship under conditions of normal, residential use, for the lifetime of the Products. This limited warranty extends only to the original, first-use retail Consumer, and is not transferable.

Limitations on Warranty Coverage: WoodTrac's® Limited Lifetime Warranty (described above) is the only warranty coverage provided by WoodTrac® for the Products, and is in lieu of all other warranties. Under the laws of certain states, there may be no implied warranties from WoodTrac®, and ALL IMPLIED WARRANTIES, INCLUDING ANY IMPLIED WARRANTY OF MERCHANTABILITY OR FITNESS FOR A PARTICULAR PURPOSE ARE DISCLAIMED AND EXCLUDED TO THE FULLEST EXTENT ALLOWED BY LAW.

Exclusions from Coverage: This limited warranty does not cover defects arising from (1) the improper installation or use of the Products; (2) abuse or neglect; (3) any commercial, rental or non-residential use of the Products (including the installation and use of the Products in a commercial or rental structure); or (4) normal wear and tear.

Exclusive Remedy: WoodTrac® will (at its option) repair or replace any defective Products (or components) at no charge, subject to confirmation of the defect and proof of purchase, as the sole and exclusive remedy under this limited warranty. This limited warranty does not cover costs for installation, returning any defective Products to WoodTrac®, for removal or other labor costs in connection with the repair or replacement of the Products, all of which shall be the responsibility of the Consumer. WoodTrac's® liability under this limited warranty shall not exceed the purchase price of the Products. WoodTrac® shall have NO LIABILITY FOR ANY INCIDENTAL OR CONSEQUENTIAL DAMAGES OF ANY KIND, and all such claims and damages are DISCLAIMED AND EXCLUDED FROM THIS LIMITED WARRANTY. You must notify WoodTrac®, in writing, within 90 days after discovering any defect in order to receive limited warranty coverage.

Some states do not allow limitations on how long an implied warranty lasts, or the exclusion or limitation of incidental or consequential damages, so the above limitations may not apply to you.

To Obtain Warranty Service or Information: For warranty inquiries or claims, contact WoodTrac® at 1-855-854-7465, 502 Middle Street, Archbold, OH (USA) 43502, woodtrac@sauder.com. Return of any defective Product may be required by WoodTrac®, or we may elect to examine the product at its location. If we ask you to ship any Products to us, we will issue you a return authorization number and provide return instructions. For returned Products to qualify for limited warranty coverage, they must be returned in the original or equivalent packaging, in accordance with the shipping instructions you receive from us, and must prominently display the return authorization number on the return package.

Stay Connected
with **WOODTRAC**
by sauder



WOODTRAC
closets by sauder

Trust Sauder

Sauder has been making wood products since 1934. Today we offer a wide range of products, mostly made right here in Archbold, Ohio, and supported by our award-winning customer service.

WoodTrac® Closets by Sauder are supported by our Limited Lifetime Warranty and offers the same made-in-the-USA advantages as the rest of our product line.

Certificate of Conformity

1. This certificate applies to the Sauder Woodworking Product identified by this Instruction Book.
2. This certificate applies to compliance of this product with the CPSC Ban on Lead-Containing Paint (16 CFR 1303).
3. This product is manufactured by:
Sauder Woodworking Company
502 Middle Street
Archbold, Ohio 43502
(419) 446-2711
4. Date of Manufacture: _____



**register your new
product online**

For immediate service, our website is available 24 hours a day, 7 days a week to order replacement parts, register your product, and view Woodtrac products. **www.woodtrac.com**

Consumer Services in United States and Canada
Mon.-Fri. – 9am-5:30pm ET(except holidays)
1-855-854-7465