



SolidTrac  
WOOD CLOSET SYSTEM

SPEC BOOK  
566327



# PRODUCT FINISHES

## PRODUCT FINISHES

Choose from 3 popular finishes. Each finish costs the same, so you don't have to pay extra for your favorite!



### **ESPRESSO**

Our darkest finish gives your closet a contemporary look



### **WHITE**

A bright, clean look. Always a classic



### **SALT OAK**

Gray tones and reclaimed wood look are on trend

## HARDWARE FINISHES

Rods, shelf/rod brackets are only available in chrome. Shelf brackets available in Chrome, Black and White.

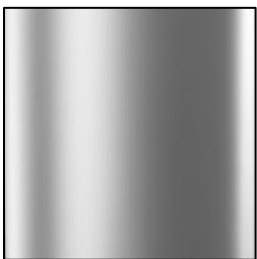

### **CHROME**

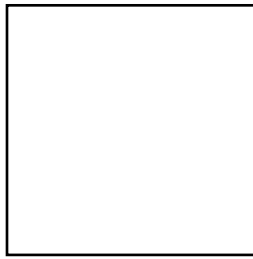

### **WHITE** Shelf Brackets only



### **BLACK** Shelf Brackets only

SYSTEM OVERVIEW

*SolidTrac is a cut-to-size fixed shelf and rod closet shelving system.*



-  High-end look with chrome rods and brackets
-  Available in multiple depths
-  Pre-finished engineered wood shelves
-  Cut-to-size means no surprises in the field
-  Grooved cleat system hides out of square drywall
-  Rated to hold 600 pounds per 8 foot section
-  Hanging design for installation before or after flooring

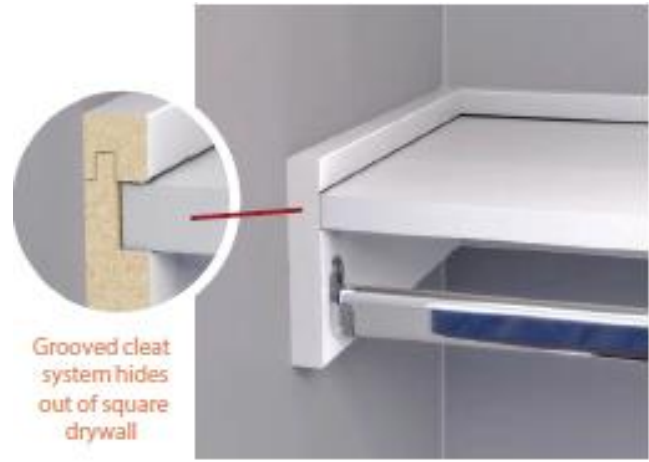

Grooved cleat system hides out of square drywall

EXPAND WITH OPTIONS

**Shelf Tower**  
(12" or 15½" depth)



**Add Drawers**  
(12" or 15½" depth)



**Corner Tower**  
(12" depth)



**MULTIPLE DEPTHS**

- 12" deep (most common)
- 15.5" deep
- 20" deep for use in pantries or linen closets
- All shelving and parts ¾" thick

# 96" L SHELVES

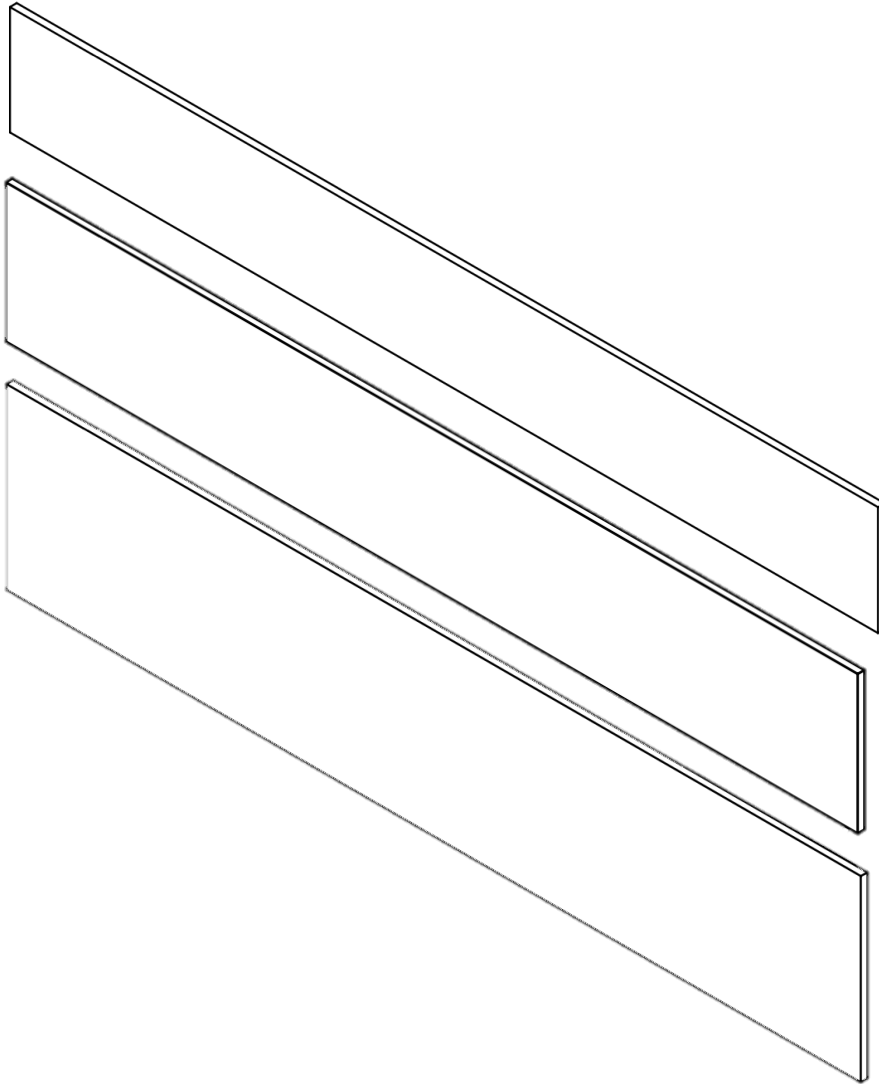

Description	Dimensions	Pack Qty	White Item #	Espresso Item #	Salt Oak Item #
<b>Shelving</b>					
12 x 96" Shelf	96" x 12" x .75"	1	428375	418851	418849
15.5 x 96" Shelf	96" x 15.5" x .75"	1	428381	419354	419353
20 x 96" Shelf	96" x 20" x .75"	1	428386	419925	419924

CLEATS

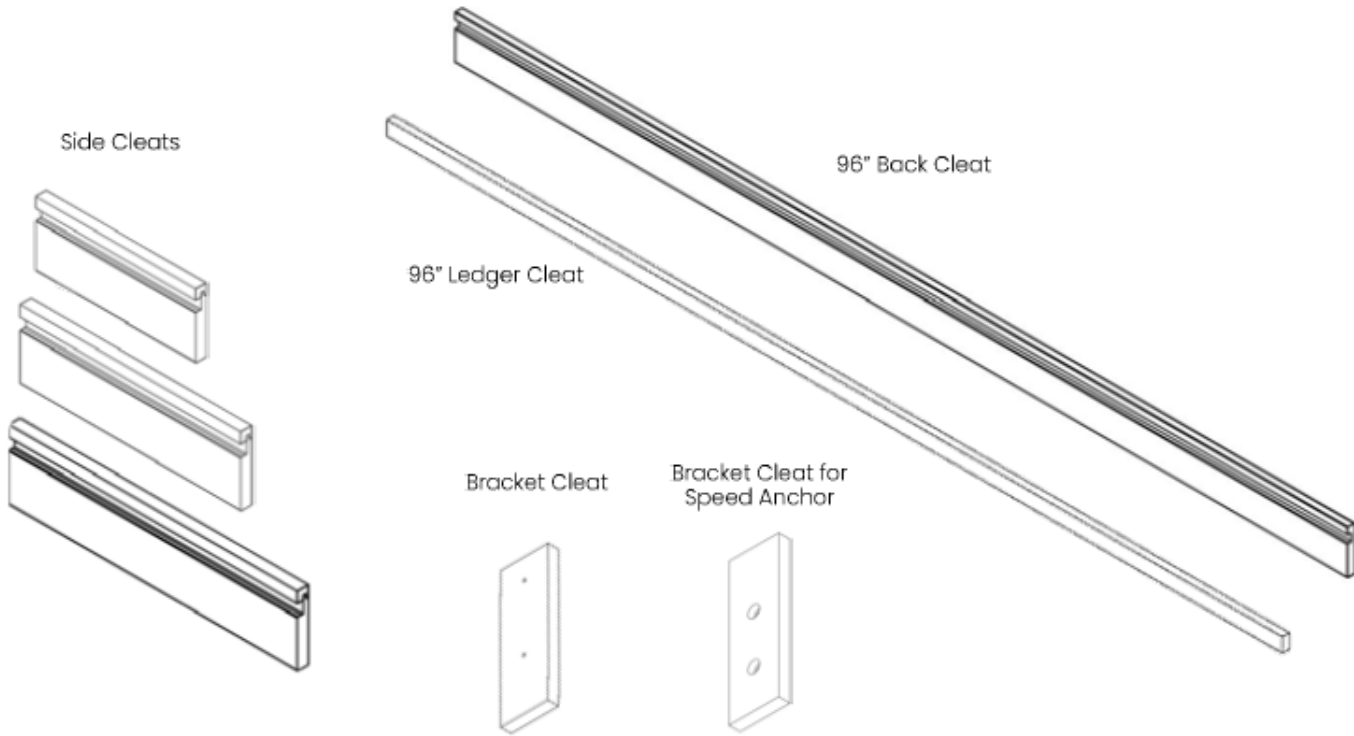

Description	Dimensions	Pack Qty	White Item #	Espresso Item #	Salt Oak Item #
<b>Cleats</b>					
96" Back Cleat	96" x 4.7" x .75"	1	428390	422452	422618
96" Ledger Cleat	96" x 1.5" x .75"	1	429317	429316	429315
12" Side Cleat	11.7" x 4.7" x .75"	1	428481	424904	424913
15.5" Side Cleat	15.2" x 4.7" x .75"	1	428482	424905	424918
20" Side Cleat	19.7" x 4.7" x .75"	1	428485	424906	424920
Bracket Cleat	9.45" x 3.3" x .75"	1	419695	419367	419366
Bracket Cleat for Metal Speed Anchor	9.45" x 3.3" x .75"	1	428154	428153	428152

# APPLIQUES (stickers)

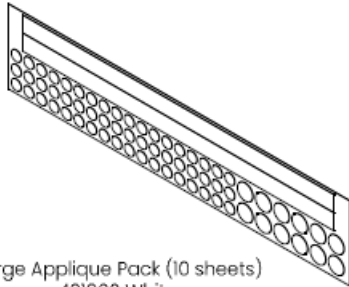

Large Applique Pack (10 sheets)  
 421962 White  
 421960 Espresso  
 421961 Salt Oak

Used to cover screws/holes or finish raw ends

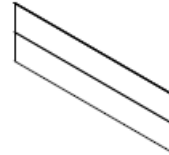

Side Cleat Appliques (40 stickers per pack)  
 428488 White  
 426470 Espresso  
 426471 Salt Oak

Used to cap side cleat raw ends

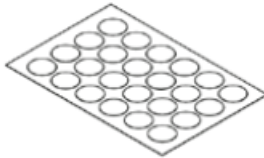

Speed Anchor Hole Appliques- 26MM circles  
 (120 stickers per pack)  
 428265 White  
 428263 Espresso  
 428264 Salt Oak

Used to cover holes in bracket cleat & elsewhere

27' Edge Banding Roll Self Adhesive  
 (19mm width)  
 429614 White  
 429615 Espresso  
 429613 Salt Oak

Touch Up Markers  
 421945 Espresso/Salt Oak  
 421944 White

Description	Pack Qty	White Item #	Espresso Item #	Salt Oak Item #
Large Applique Pack (10 sheets)	10	428487	421960	421961
Side Cleat Applique (40 stickers)	40	428488	426470	426471
Speed Anchor Hole Applique (120 stickers)	1	428265	428263	428264
Touch up Markers Pack (10 markers)	10		421945	421945
Touch up Marker Large (1 per pack)	1	421944		
27' Edge Banding Roll Self Adhesive	1	429614	429615	429613

HARDWARE

Shelf/Rod Support Bracket  
422421 Chrome



Rod Support Side Bracket



419914 Chrome

430448 Chrome  
(for ledger)

Shelf/Cleat Angle Bracket  
422641 Black  
422642 White  
422643 Gray/Zinc



Secures Shelf to Side Cleat.  
Secures Uprights to Top Shelf

Rod End Cap  
425296 Chrome



Shelf Bracket  
422319 Black  
419787 White  
419788 Gray/Zinc



Heavy Duty Shelf Bracket  
422554 Black  
422555 White



Heavy Duty Shelf Bracket  
423311 Chrome



Rod Coupler  
425724 Chrome

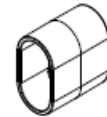

For Closet Rods splices

Closet Rod  
419786 Chrome



Description	Pack Qty	Chrome Item #	Black Item #	White Item #	Zinc Item #
<b>Brackets</b>					
Shelf/Rod Support Bracket (10 pack)	10	422421			
Shelf Bracket (no rod support)	20		422319	419787	419788
Heavy Duty Shelf Bracket (no rod support)	10		422554	422555	
Heavy Duty Shelf Bracket (no rod support)	10	423311			
Shelf/Cleat Angle Bracket (40/pack)	40		422641	422642	422643
<b>Rods &amp; Rod Hardware</b>					
96" Closet Rod (10 pack)	10	419786			
Rod support side bracket (20 pack)	20	419914			
Rod Cup for use with Ledger (20 pack)	20	430448			
Rod End Cap (10 pack)	10	425296			
Rod Splice Coupler (10 pack)	10	425724			

Hardware finish to wood finish match

- Black for Espresso
- Zinc for Salt Oak
- Chrome compatible with all finishes

# HARDWARE- SCREWS

1 7/8" Screws  
424600 Black



Use with Back Cleats, Side Cleats, Bracket Cleats where studs are available

1" Screws (auger)  
422780 Black



Use to attach Side Cleats to Uprights

3/4" Screws #8  
419926 Chrome



Use with Rod Support Side Bracket and Shelf/Rod Support Bracket

3/4" Screws #10 Self Tap  
419927 Chrome



Secures Shelf/Rod Support Bracket to Closet Rod

3/4" Wafer Head Screw  
423466 Black  
423469 White  
423468 Zinc



Use with Heavy Duty Shelf Bracket

5/8" Wafer Head Screw  
422644 Black  
422645 White  
422646 Zinc



Use with Shelf Cleat Angle Bracket

Wall Anchor  
419791 White



Use with Back Cleats, Side Cleats, Bracket Cleats where studs are not available

Description	Chrome Item #	Black Item #	White Item #	Zinc Item #
1 7/8" Screws (Back Cleats, Side Cleats, Bracket Cleats)		424600		
1" Screws (Auger) Connect Side Cleats to Uprights		422780		
3/4" Screws #8 (Chrome Bracket)	419926			
3/4" Screws #10 (Self Tap for Rod)	419927			
3/4" Wafer Head Screw for HD Shelf Bracket		423466	423469	423468
Wafer Head Screw (250/Box) for Shelf/Cleat Angle Bracket		422644	422645	422646
Wall Anchor			419791	

Hardware finish to wood finish match

- Black for Espresso
- Zinc for Salt Oak
- Chrome compatible with all finishes



# SHELF TOWERS & CORNER UNITS

Right Upright- 12" Deep  
Right Upright- 15.5" Deep

Left Upright- 12" Deep  
Left Upright- 15.5" Deep

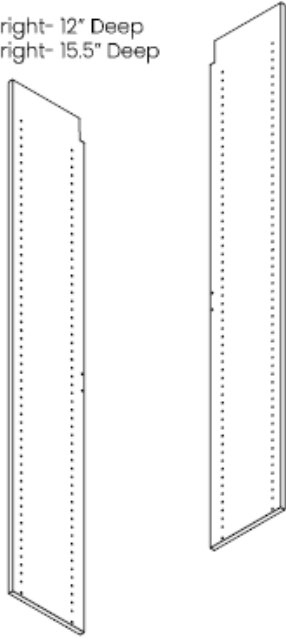

24" W Shelf Pack- 12" Deep  
24" W Shelf Pack- 15.5" Deep

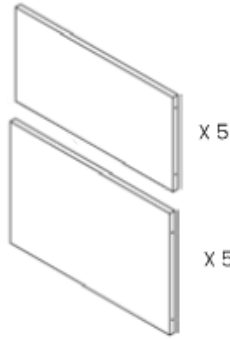

Includes hardware & cleat to create shelf tower

24" W Drawer 10" H- 12" Deep  
24" W Drawer 10" H- 15.5" Deep

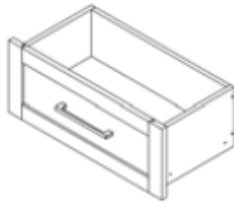

24" W Shelf Tower =  
Left Upright + Right  
Upright + 24" W Shelf  
Pack

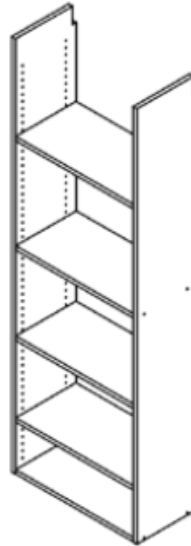

Installs directly under  
top shelf. Shelf Tower  
hangs on wall above  
baseboard.

Corner Unit =  
Left Upright + Right  
Upright + Corner Unit  
Shelf Pack

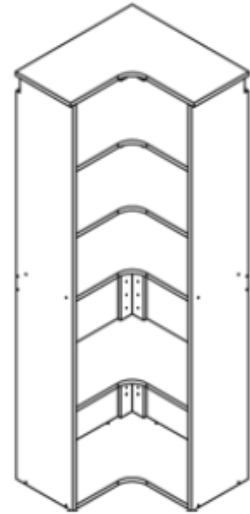

Requires 2 Shelf  
Connectors to tie into  
top shelf.

Corner Unit hangs on  
wall above baseboard.

Description	Dimensions	Pack Qty	White Item #	Espresso Item #	Salt Oak Item #	Pack List	Each List
<b>Uprights</b>							
Left Upright bored one side- 12" depth	78" x 12.4" x .75"	1	428489	424427	424431	\$ 40.69	\$ 40.69
Right Upright bored one side- 12" depth	78" x 12.4" x .75"	1	428490	424428	424432	\$ 40.69	\$ 40.69
Left Upright bored one side- 15.5" depth	78" x 15.86" x .75"	1	425889	423243	425887	\$ 62.48	\$ 62.48
Right Upright bored one side- 15.5" depth	78" x 15.86" x .75"	1	425890	423244	425888	\$ 62.48	\$ 62.48
<b>Shelf Packs</b>							
24" W Shelf Tower Pack- 12" depth- 5 shelves	24" x 12.4" x .75"	1	428491	424907	424910	\$ 87.15	\$ 87.15
24" W Shelf Tower Pack- 15.5" depth- 5 shelves	24" x 15.86" x .75"	1	425886	424424	425885	\$ 97.91	\$ 97.91
Corner Unit Shelf pack- 12" depth- 5 shelves	26" x 26" x .75	1	428492	424948	424582	\$ 270.90	\$ 270.90
<b>Drawers</b>							
24" Large 10" H Drawer- 12" depth	24" x 10" x 11.7"	1	428493	422422	422424	\$ 84.00	\$ 84.00
24" Large 10" H Drawer- 15.5" depth (soft close)	24" x 10" x 15.2"	1	425697	425676	425688	\$ 124.69	\$ 124.69
<b>Accessories</b>							
Valet Rod (Chrome)	12"	1	429221	429221	429221	\$ 32.70	\$ 32.70

# SHELF CONNECTORS

Shelf Connector

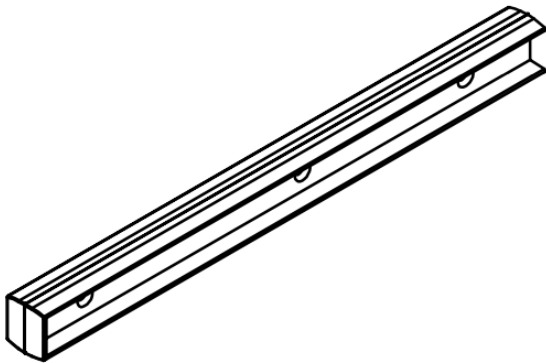

Conceals Shelf Splice

Corner Shelf Connector

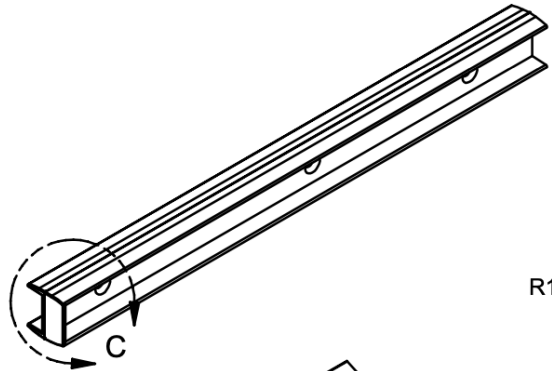

R1

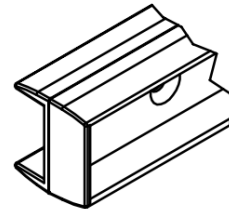

DETAIL C

Conceals Shelf Splice in corners

Description	Dimensions	Pack Qty	White Item #	Espresso Item #	Salt Oak Item #	Pack List	Each List
<b>Shelf Connectors</b>							
12" Shelf Connector	11.65" x 1" x .86"	10	422848	422844	422852	\$ 37.54	\$ 3.75
12" Corner Shelf Connector	11.65" x 1" x .86"	10	422849	422845	422853	\$ 37.54	\$ 3.75
15.5" Shelf Connector	15.15" x 1" x .86"	10	422850	422846	422854	\$ 44.10	\$ 4.41
15.5" Corner Shelf Connector	15.15" x 1" x .86"	10	422851	422847	422855	\$ 44.10	\$ 4.41

# INSTALLATION HEIGHT STANDARDS

AFF- Above Finished Floor.

- Install bottom of cleats 3 7/8" below desired AFF height to have top of shelf line up with AFF
- Shelf must be supported by bracket or side cleat at most every 32"
- Shelves not ending on a side cleat must be supported by a bracket no more than 10" from the shelf edge.

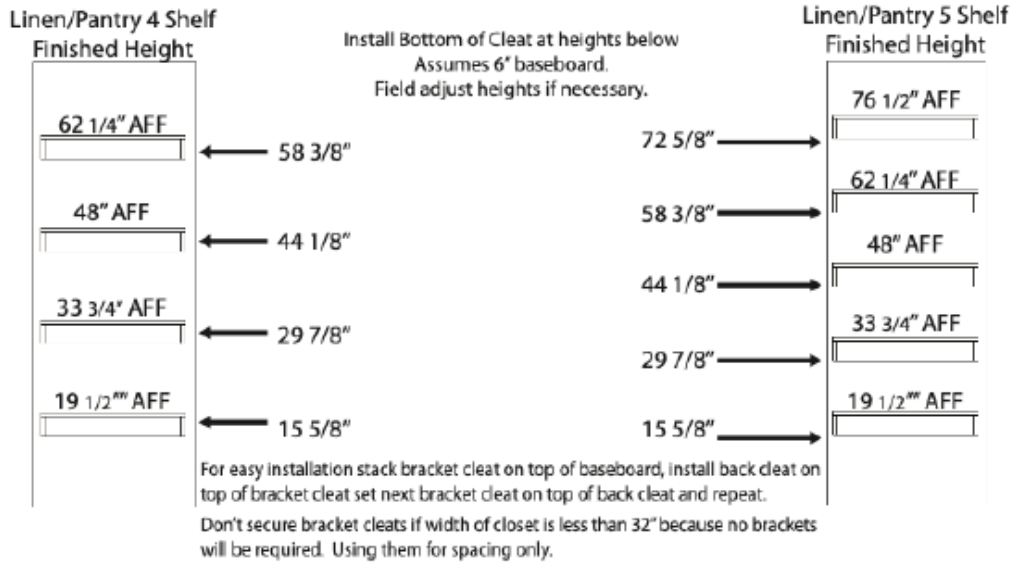
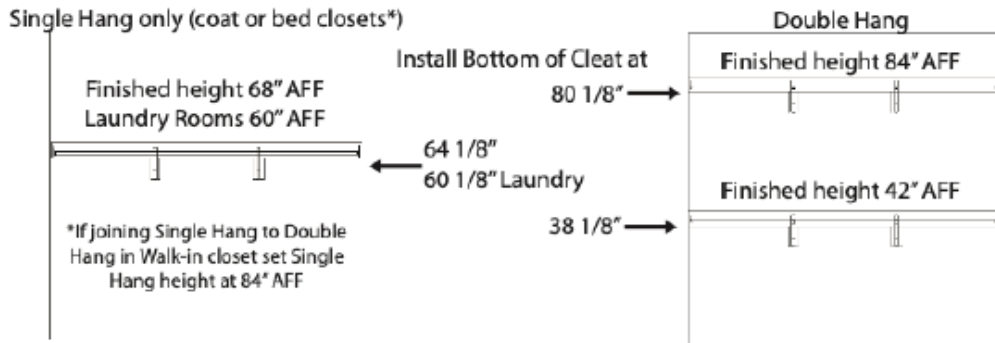

INSTALLATION

*Hanging Back and Side Cleats*

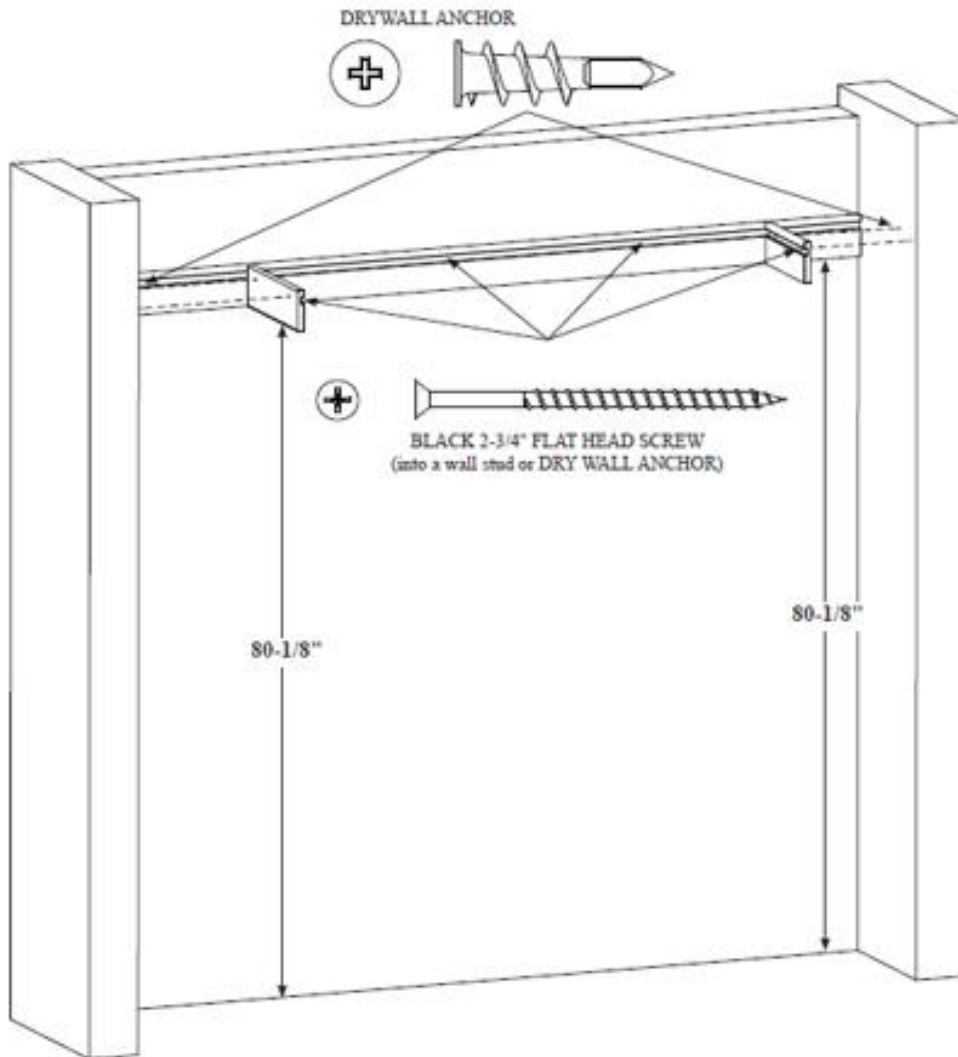

Cut to size a 96" BACK CLEAT and fasten it to the back wall 80-1/8" from the floor using a BLACK 2-3/4" FLAT HEAD SCREW through the groove of the BACK CLEAT and into all wall studs or a DRYWALL ANCHOR.

**NOTE:** Screws into wall studs must be 16" apart. If using DRYWALL ANCHORS only, they must be 12" apart.

Use DRYWALL ANCHORS and BLACK 2-3/4" FLAT HEAD SCREWS to fasten SIDE CLEATS to the wall.

# INSTALLATION

## Shelf Installation

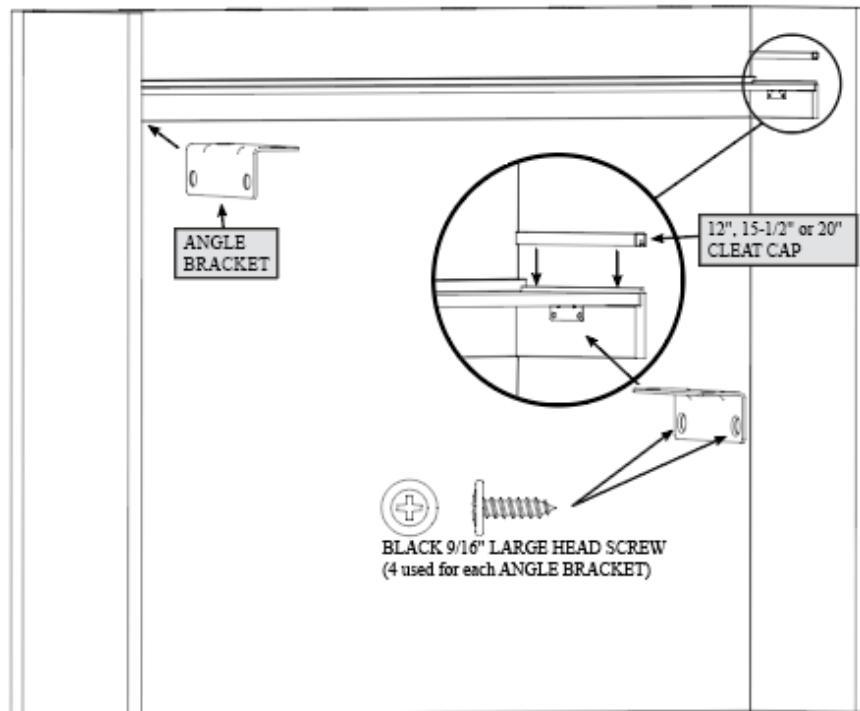
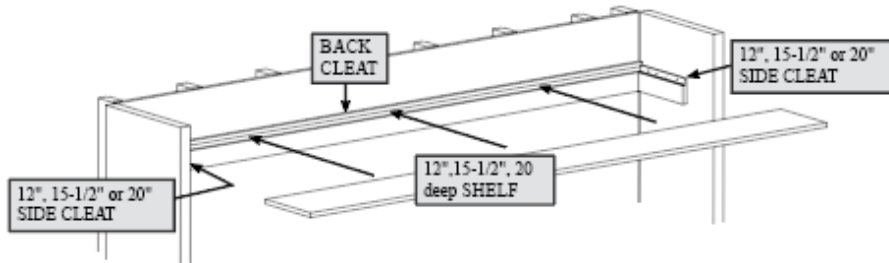

Cut to size a 96" SHELF and slide it into the grooves of the SIDE CLEATS and BACK CLEAT as shown in the upper diagram.

Fasten the SHELF to the SIDE CLEATS with two ANGLE BRACKETS and eight BLACK 9/16" LARGE HEAD SCREWS. It is recommended that you glue the CLEAT CAP to the SIDE CLEAT.

**NOTE:** If you are installing a closet rod, install ROD SUPPORT BRACKETS using the Rod Support Side Bracket Template, before installing ANGLE BRACKETS.

**NOTE:** If you purchased the Upright Pack, Adjustable Shelf/Brace Pack, L-Shape Corner Unit, and/or the 24" Large Drawer Kit, see those instruction booklets on how to install those components.

# INSTALLATION- SHELF TOWER

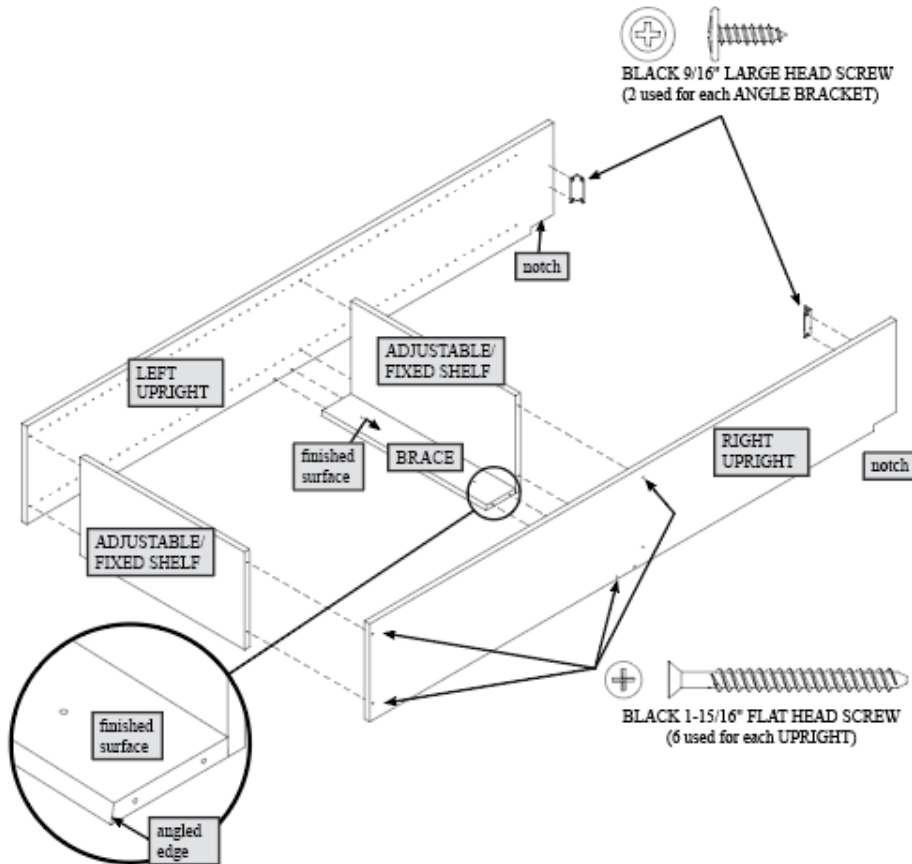

Before proceeding, see the CLEAT and SHELF Installation booklet to install the BACK and SIDE CLEATS. Then return to this book.

Fasten an ANGLE BRACKET to the center of each UPRIGHT. Use four BLACK 9/16" LARGE HEAD SCREW for the ANGLE BRACKETS.

NOTE: There are no predrilled holes in the UPRIGHTS.

Fasten the UPRIGHTS to the ADJUSTABLE/FIXED SHELVES and BRACE. Use twelve BLACK 1-15/16" FLAT HEAD SCREWS.

# INSTALLATION- SHELF TOWER

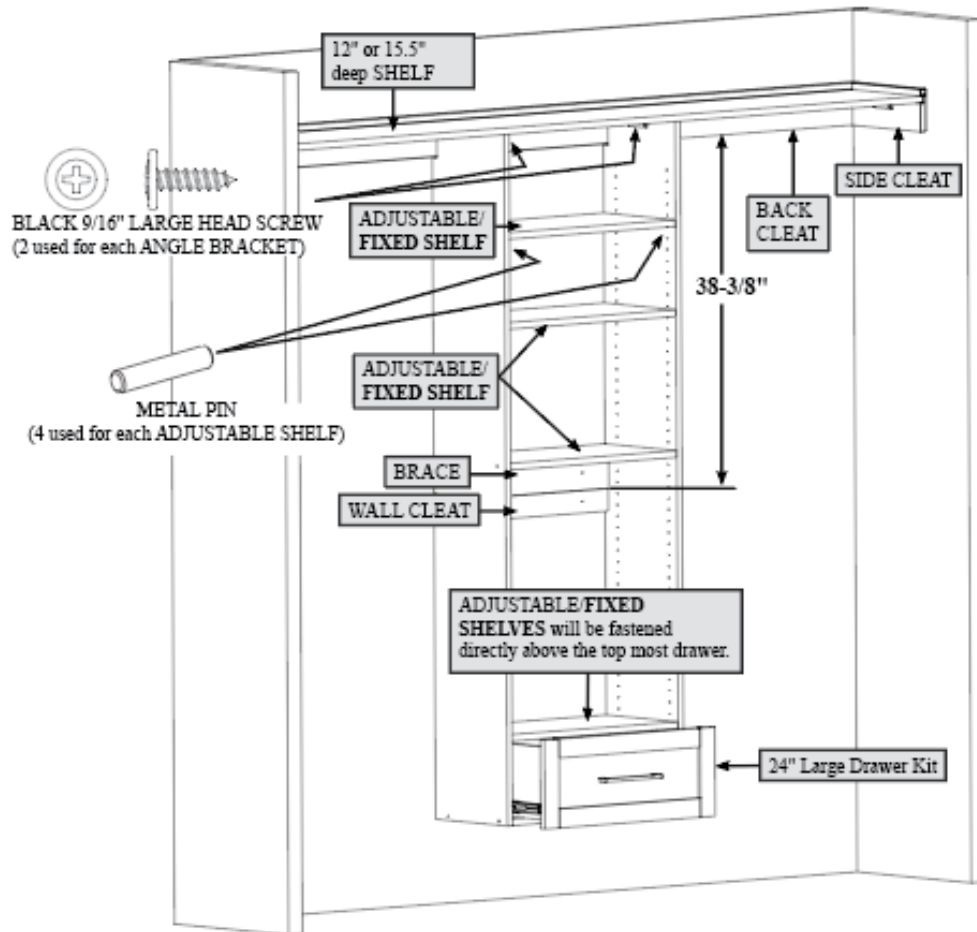

Fasten the WALL CLEAT to the WALL with a BLACK 2-3/4" FLAT HEAD SCREW and a DRYWALL ANCHOR if necessary.  
 NOTE: The top edge of the WALL CLEAT must be 38-3/8" from the bottom edge of the BACK CLEAT.

Hang your UPRIGHT unit onto the WALL CLEAT.

Fasten the BRACE to the WALL with a BLACK 2-3/4" FLAT HEAD SCREW and a DRYWALL ANCHOR if necessary.

Fasten the UPRIGHTS to the SHELF. Use four BLACK 9/16" LARGE HEAD SCREWS through the ANGLE BRACKETS and into the SHELF.

If you purchased the 24" Drawer Kit, assemble that now and then return to this booklet.

Insert METAL PINS into the hole locations of your choice in the UPRIGHTS. Set the additional ADJUSTABLE SHELVES/FIXED SHELVES onto the METAL PINS.

# INSTALLATION- DRAWER

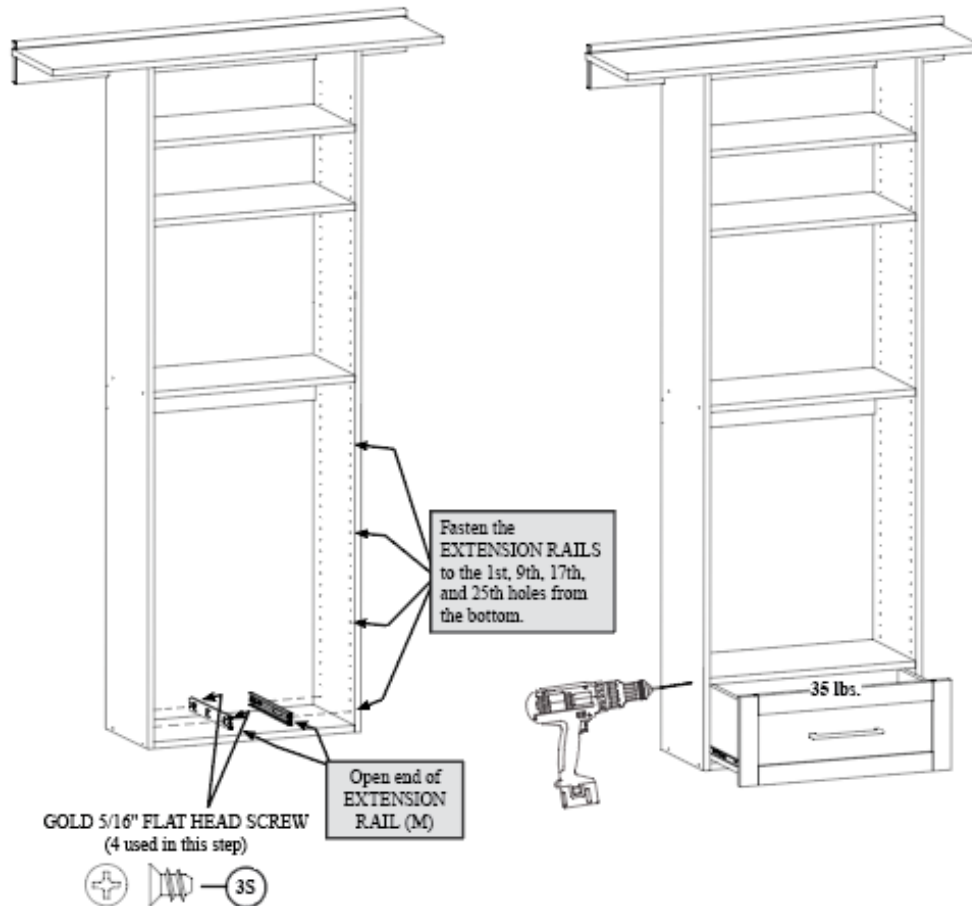

Fasten the EXTENSION RAILS (M) to the UPRIGHTS at the desired height. Use four GOLD 5/16" FLAT HEAD SCREWS (3S).

**NOTE:** For each EXTENSION RAIL, turn a SCREW into the rear holes. Then, slide the inner cartridge of the EXTENSION RAIL in to find the other hole that lines up with the hole in the END. Turn a SCREW into this hole.

To insert the drawer into your unit, line up the EXTENSION SLIDES on the drawer with the EXTENSION RAILS on the unit and push the drawer into the unit until the drawer is fully inserted. The drawer will push in hard until it is all the way in, then it will slide in and out easier.

With a drill and 3/16" drill bit, finish drilling out holes needed to fasten an ADJUSTABLE/FIXED SHELF directly above the upper most drawer as shown. Fasten the ADJUSTABLE/FIXED SHELF to the UPRIGHTS. Use four BLACK 1-15/16" FLAT HEAD SCREWS.



*INSTALLATION- CORNER UNIT*

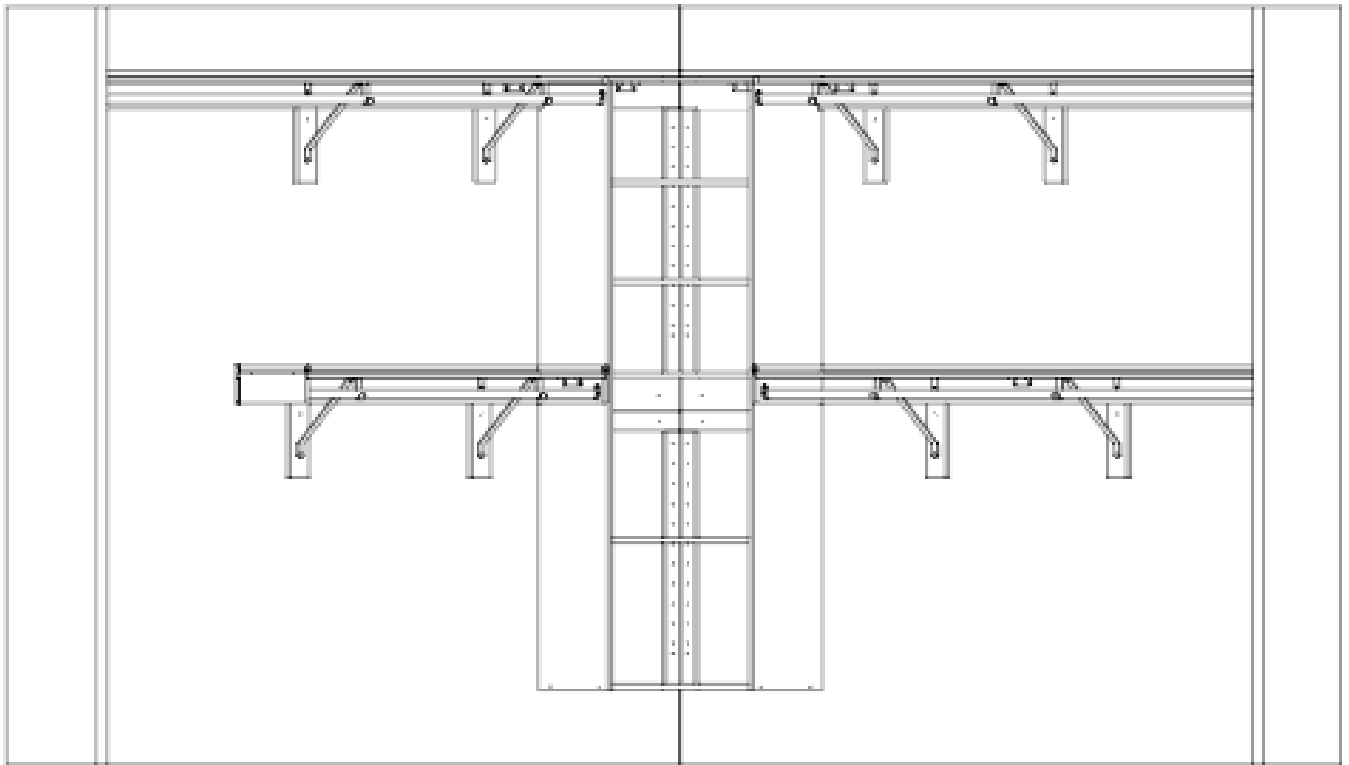

INSTALLATION- CORNER UNIT

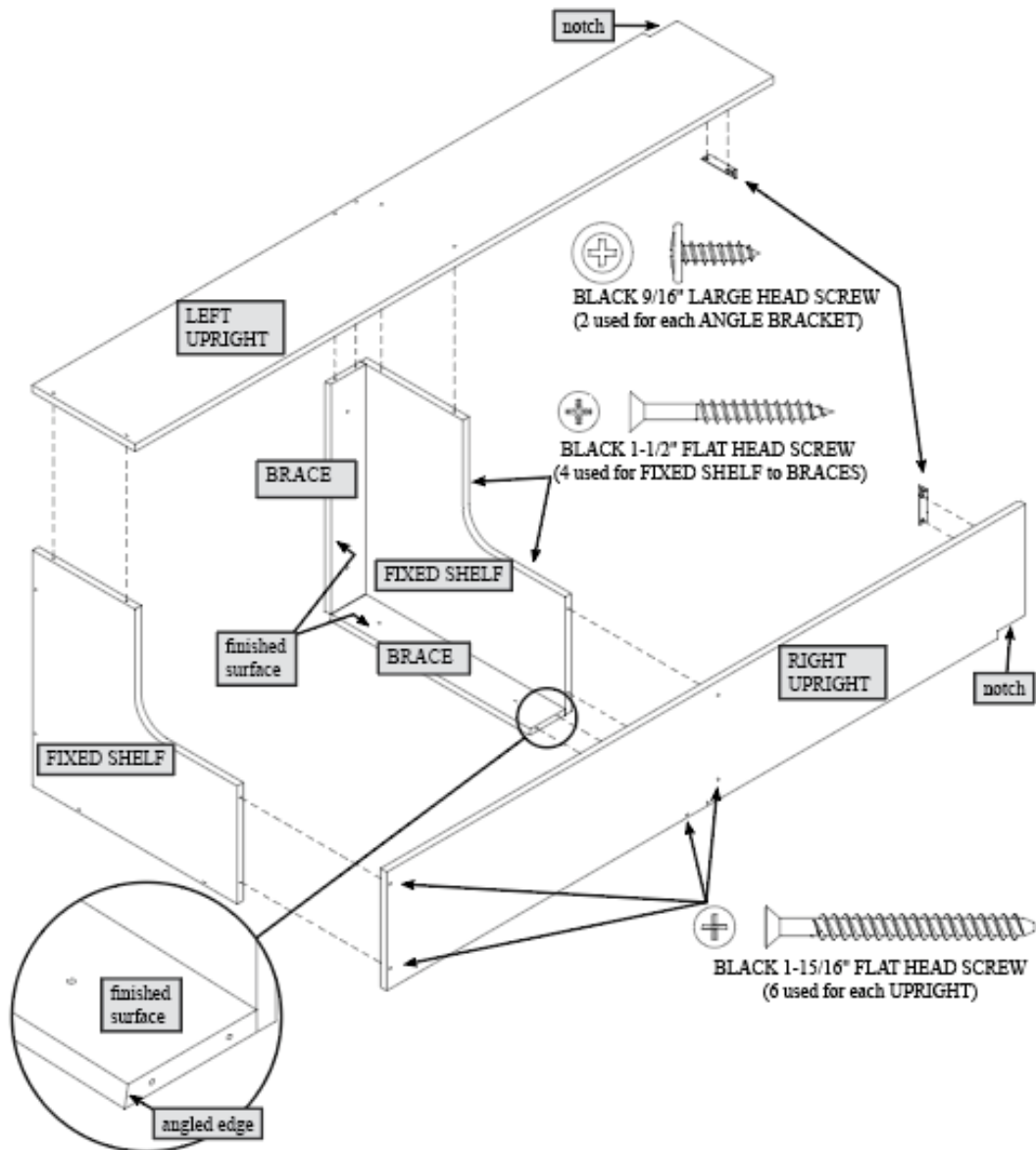

Fasten an ANGLE BRACKET to the center of each UPRIGHT. Use four BLACK 9/16" LARGE HEAD SCREW for the ANGLE BRACKETS.  
 NOTE: There are no predrilled holes in the UPRIGHTS.

Fasten two BRACES to a FIXED SHELF. Use four BLACK 1-1/2" FLAT HEAD SCREWS.  
 NOTE: There are no predrilled holes in the BRACES.

Fasten the UPRIGHTS to the FIXED SHELVES and BRACES. Use twelve BLACK 1-15/16" FLAT HEAD SCREWS.

# INSTALLATION- CORNER UNIT

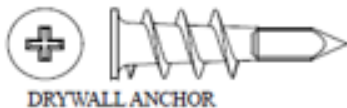
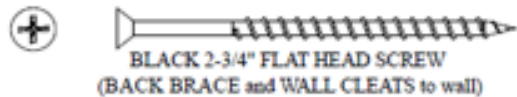
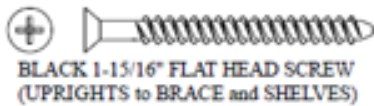
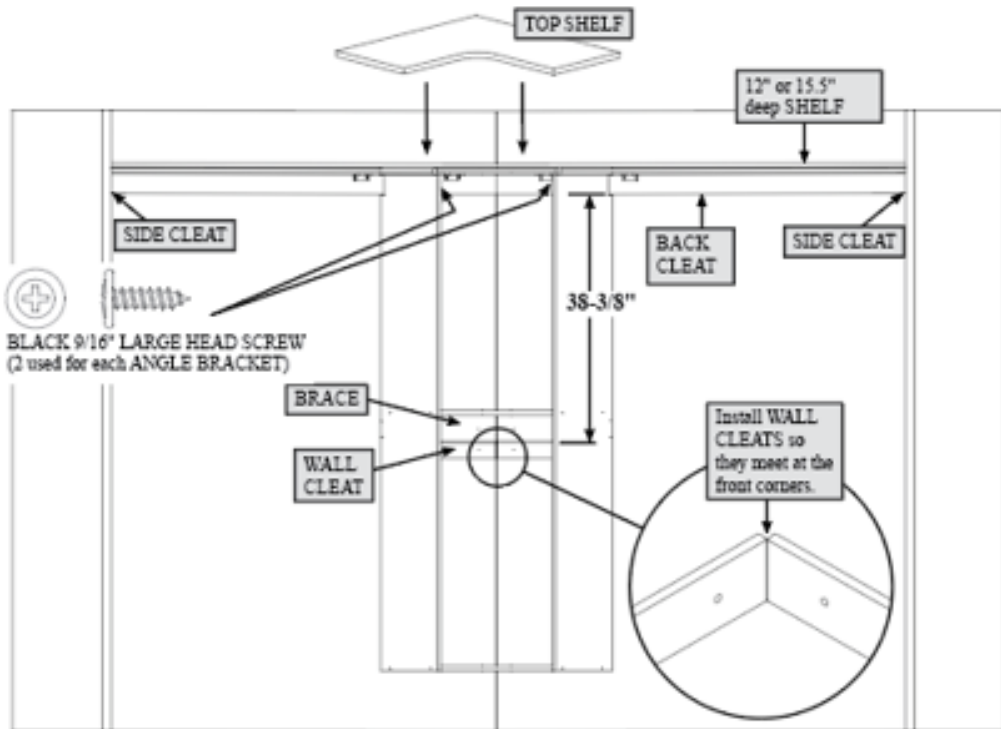

Fasten the WALL CLEAT to the WALL with a BLACK 2-3/4\" FLAT HEAD SCREW and a DRYWALL ANCHOR if necessary.

**NOTE:** The top edge of the WALL CLEAT must be 38-3/8\" from the bottom edge of the BACK CLEAT.

Hang your CORNER unit onto the WALL CLEAT.

Fasten the BRACE to the WALL with a BLACK 2-3/4\" FLAT HEAD SCREW and a DRYWALL ANCHOR if necessary.

Fasten the UPRIGHTS to the TOP SHELF. Use four BLACK 9/16\" LARGE HEAD SCREWS through the ANGLE BRACKETS and into the TOP SHELF.

## INSTALLATION- CORNER UNIT

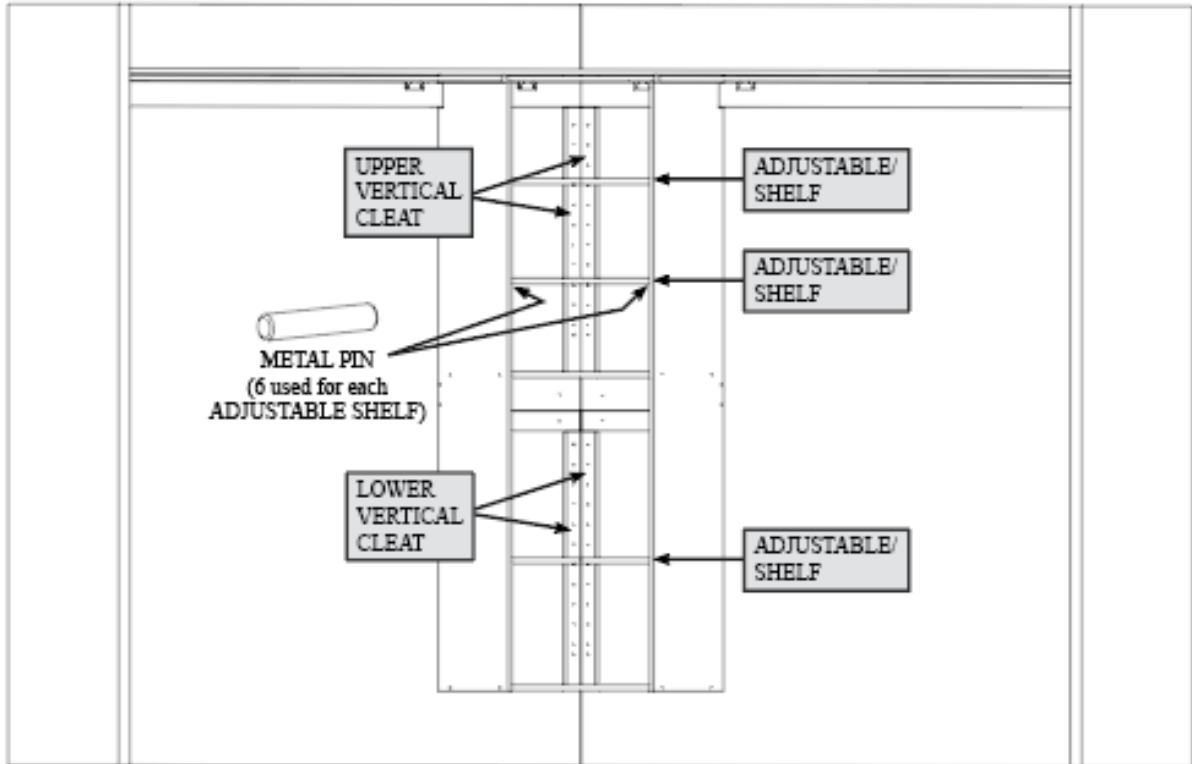

Fasten the VERTICAL CLEATS to corner studs in your wall. Use the BLACK 2-3/4" FLAT HEAD SCREWS.

Insert METAL PINS into the hole locations of your choice in the UPRIGHTS and VERTICAL CLEATS. Set the ADJUSTABLE SHELVES onto the METAL PINS.

# INSTALLATION

**RECOMMENDED MAXIMUM LOAD:**

Installation into wall studs offers a recommended maximum weight capacity of 625 lbs or 78.125 lbs per foot.

Installation into drywall anchors offers a recommended maximum weight capacity of 625 lbs or 78.125 lbs per foot.

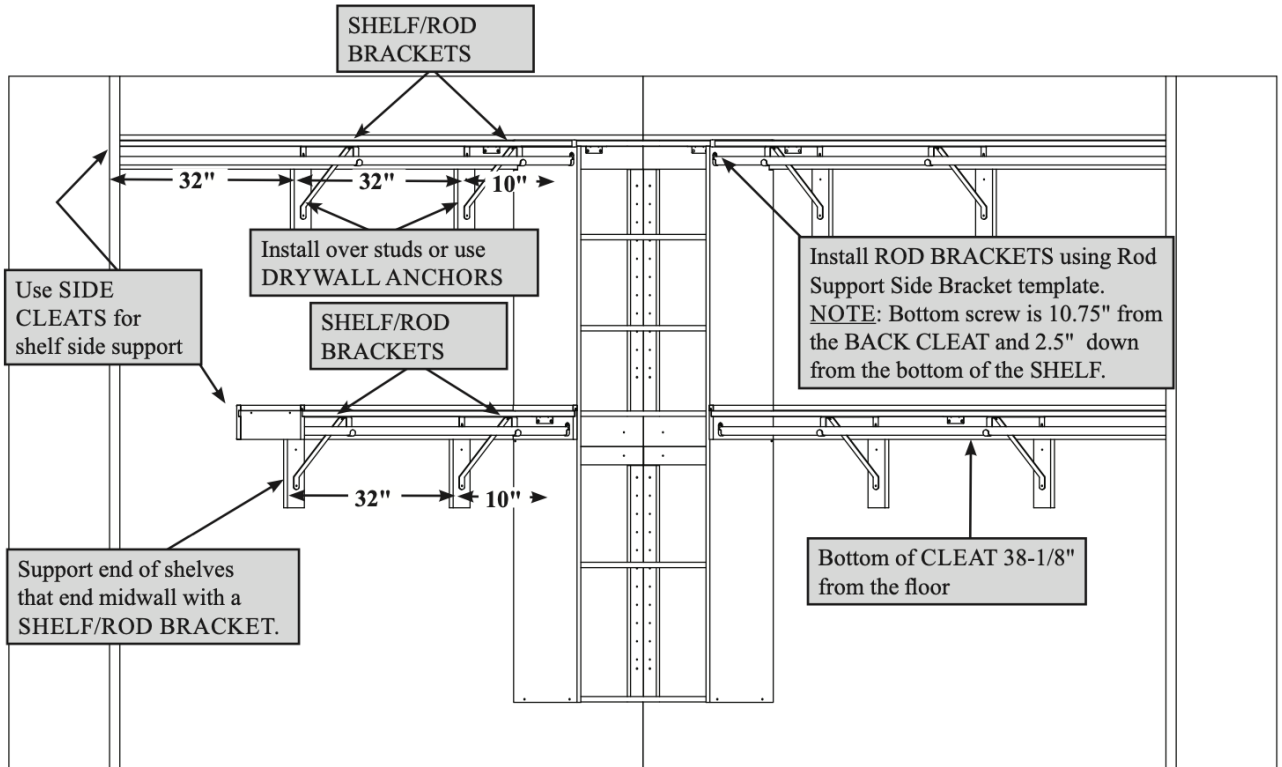

Fasten SHELF/ROD BRACKET CLEATS over the wall studs using a BLACK 2-3/4" FLAT HEAD SCREW and a DRYWALL ANCHOR if necessary

**NOTE:** Position the ROD BRACKET CLEATS with the upper hole 1-7/16" from the top edge.

Fasten SHELF/ROD BRACKETS with the SILVER 3/4" FLAT HEAD SCREWS ensuring that the SHELF is level.

Fasten ROD BRACKETS on SIDE CLEATS, UPRIGHTS or BACK CLEATS using the SILVER 3/4" FLAT HEAD SCREWS.

Fasten CLOSET RODS securing them with SILVER 3/4" SELF DRILLING SCREWS through the SHELF/ROD BRACKETS.

Peel appliques from the APPLIQUE CARDS to cover screws and edges of SIDE CLEATS.

# WARRANTY & WARNINGS

## WOODTRAC® CLOSET PRODUCTS LIMITED WARRANTY

WoodTrac® by Sauder provides limited lifetime warranty coverage on WoodTrac® Closet Products (the "Products") to the original first use retail consumer ("Consumer") as set forth in this limited warranty statement. This limited warranty gives you specific legal rights, and you may also have other rights which vary from state to state.

**Limited Lifetime Warranty Coverage:** WoodTrac® warrants that the Products will be free from defects in material and workmanship under conditions of normal, residential use, for the lifetime of the Products. This limited warranty extends only to the original, first-use retail Consumer, and is not transferable.

**Limitations on Warranty Coverage:** WoodTrac's® Limited Lifetime Warranty (described above) is the only warranty coverage provided by WoodTrac® for the Products, and is in lieu of all other warranties. Under the laws of certain states, there may be no implied warranties from WoodTrac®, and ALL IMPLIED WARRANTIES, INCLUDING ANY IMPLIED WARRANTY OF MERCHANTABILITY OR FITNESS FOR A PARTICULAR PURPOSE ARE DISCLAIMED AND EXCLUDED TO THE FULLEST EXTENT ALLOWED BY LAW.

**Exclusions from Coverage:** This limited warranty does not cover defects arising from (1) the improper installation or use of the Products; (2) abuse or neglect; (3) any commercial, rental or non-residential use of the Products (including the installation and use of the Products in a commercial or rental structure); or (4) normal wear and tear.

**Exclusive Remedy:** WoodTrac® will (at its option) repair or replace any defective Products (or components) at no charge, subject to confirmation of the defect and proof of purchase, as the sole and exclusive remedy under this limited warranty. This limited warranty does not cover costs for installation, returning any defective Products to WoodTrac®, for removal or other labor costs in connection with the repair or replacement of the Products, all of which shall be the responsibility of the Consumer. WoodTrac's® liability under this limited warranty shall not exceed the purchase price of the Products. WoodTrac® shall have NO LIABILITY FOR ANY INCIDENTAL OR CONSEQUENTIAL DAMAGES OF ANY KIND, and all such claims and damages are DISCLAIMED AND EXCLUDED FROM THIS LIMITED WARRANTY. You must notify WoodTrac®, in writing, within 90 days after discovering any defect in order to receive limited warranty coverage.

Some states do not allow limitations on how long an implied warranty lasts, or the exclusion or limitation of incidental or consequential damages, so the above limitations may not apply to you.

**To Obtain Warranty Service or Information:** For warranty inquiries or claims, contact WoodTrac® at 1-855-854-7465, 502 Middle Street, Archbold, OH (USA) 43502, woodtrac@sauder.com. Return of any defective Product may be required by WoodTrac®, or we may elect to examine the product at its location. If we ask you to ship any Products to us, we will issue you a return authorization number and provide return instructions. For returned Products to qualify for limited warranty coverage, they must be returned in the original or equivalent packaging, in accordance with the shipping instructions you receive from us, and must prominently display the return authorization number on the return package.

### WARNING

Please use your furniture correctly and safely. Improper use can cause safety hazards, or damage to your furniture or household items. *Carefully read the following chart.*

Look out for:	What can happen:	How to avoid the problem:
<ul style="list-style-type: none"> <li>Loose or unstable closet components.</li> <li>Tall closet component structures.</li> <li>Closet component structures that are over five feet tall and placed in an open area or a walk-in closet.</li> </ul>	<ul style="list-style-type: none"> <li>Risk of injury</li> <li>Closet components that are not properly connected can easily slide against each other and cause the structure to be unstable and tip over.</li> <li>A tall closet structure can tip unless it is properly secured.</li> </ul>	<ul style="list-style-type: none"> <li>Closet components must be securely attached to each other from side to side, and top to bottom.</li> <li>Secure the closet structure to a wall stud whenever possible. If you cannot use a wall stud, use the supplied wall anchors into your drywall.</li> </ul> <p>(If attaching the product to a wall made of concrete, plaster, or other material, purchase and use the appropriate mounting hardware. The attachment hardware must be rated to provide a minimum of 50 pounds of pull strength.)</p>
<ul style="list-style-type: none"> <li>Overloaded drawers and shelves.</li> </ul>	<ul style="list-style-type: none"> <li>Risk of injury.</li> <li>Top-heavy furniture can tip over.</li> <li>Overloaded drawers or shelves can break.</li> </ul>	<ul style="list-style-type: none"> <li>Never exceed the weight limits shown in the instructions.</li> <li>Work from bottom to top when loading shelves and drawers. Place the heavier items on the lower shelves or in lower drawers.</li> </ul>
<ul style="list-style-type: none"> <li>Improper use of furniture to support TVs.</li> <li>Setting TVs on furniture items not intended to support them is hazardous.</li> </ul>	<ul style="list-style-type: none"> <li>Risk of injury.</li> <li>TVs can be very heavy. Plus the weight and location of the picture tube tends to make TVs unbalanced and prone to tipping forward.</li> </ul>	<ul style="list-style-type: none"> <li>This product is not designed to support a television.</li> </ul>

## PRODUCT PERFORMANCE

### LOAD SPECIFICATIONS

Product	Anchoring Method	Recommended Load Limits
SolidTrac	Wooden studs	78 lbs per foot (32" Span between brackets)
SolidTrac	Drywall Anchors	78 lbs per foot (32" Span between brackets)

### SURFACE PERFORMANCE

WoodTrac Closets wood components are made with silicone coated high definition micropapers laminated over either MDF or Particleboard depending on the part. Performance results below.



Standard Plus/ Wrapping Plus Grade Paper-Engineering Specification

SSN – 1220 r.1

AESTHETICS		
Attribute	Test Method	Specification/Assessment
Color (Evaluated using the D65 Lighting)	Visual Compliance to the Color Standard – ASTM D-1729-96	Pass / Fail
Coating Smoothness	Visual Compliance to the Color Standard	Pass / Fail
Gloss	Gardner Micro Gloss - @ 60° (MD) – ASTM D-523-99	±15% of standard
Fidelity/Registration	Visual Compliance to the Color Standard	Pass / Fail
PERFORMANCE		
Attribute	Test Method	Specification/Assessment
Wear Resistance	For paper, correlated to coating weight	=> 3 grams/m <sup>2</sup>
	For laminates, CPA WR-01-2009	>250 cycles
Scratch Resistance	For paper, correlated to coating weight	=> 3 grams/m <sup>2</sup>
	For laminates, Hoffman-Paint & Coating Testing Methods p.557 ASTM - D 5178 (Breaking Point)	=> 100 grams
MEK Resistance	ASTM - D 4752	=> 50 Dble Rubs
Boiling Water Resistance	Fed. Spec. AA-11-001895B	No Effect after 1 hour
Color Stability at Elevated Temperature	For paper, Sauder LP074; Color Stability Standard Method	Delta <.5 or Visual Compliance to Color Standard
Water Resistance	ANSI / NEMA LD 3-2005 - High Pressure Decorative Laminates Section 3.4 Distilled Water	No Effect after 4 hours
Stain Resistance	ANSI / NEMA LD 3-2005 - High Pressure Decorative Laminates Section 3.4; cooking oil, coffee, tea, mustard, catsup	No Effect after 4 hours
Tape Resistance	ASTM – D 3330 or correlated method	100% Tape Adhesion Failure (Based on 10day tape pull)
Coating / Ink Adhesion	ASTM – D 3359	0% Failure
Coefficient of Friction	ASTM – D 1894	.125 Kinetic (min)

## PRODUCT COMPOSITION & CARE

### PRODUCT COMPOSITION

Our SolidTrac wood parts are a combination of 3/4" furniture-grade particleboard and MDF (Medium Density Fiberboard) with a high-definition micro paper laminate. The high heat and pressure used in manufacturing result in a very strong, environmentally-friendly product.

Our product is made of over 80% recycled products. All wood panels used at our production facility are "Environmentally Preferred Product" (EPP) by the Composite Panel Association.

### PRODUCT CARE

While laminate products are durable, like any wood product they are not water resistant. We recommend quickly wiping any spilled liquid to prevent damage.

To clean we recommend light dusting or wiping the surface with a wax-based polish (Pledge or Endust, for example) and a dry cloth. Spray should be applied to cloth and not directly to furniture. Never use any type of abrasive cleaner or soap detergent on laminate surfaces.





