

dura **STRONG**™
RUBBER PAVING TILES



sofSURFACES
RUBBER TILE SOLUTIONS

**INSTALLATION
PROCEDURES**

INSTALLATION GUIDE

INTRODUCTION

duraSTRONG™ rubber paving tiles are suitable for use as an architectural paver on patios and terraces. Other products and installation manuals are available for other applications.

duraSTRONG tiles are suitable for use as an overlayment for most conventional roofing systems, including built-up and single ply membrane products.

The locking feature, coupled with resiliency and color diversity, are the unique benefits that have positioned duraSTRONG as the preferred product for rooftop ballast and architectural paver applications.

The duraSTRONG system has been designed to be installed using specific installation methods developed to ensure the long-term performance of the surface. Each step in the installation process is critical to ensure a successful installation. This manual has been designed utilizing the best installation techniques taken from various professional duraSTRONG installation crews across North America. The manual was designed to ensure that the duraSTRONG surface has been installed according to specification and has also incorporated the most efficient methods of installation.

TOOLS & CONSUMABLES

Like any job, your duraSTRONG installation will go much smoother with the proper tools. The following list of tools and consumables are recommended for your upcoming project:

- Broom
- Leaf blower
- Aluminum straightedge 30" minimum – black lettering
- 24" square and speed square – yellow or white lettering
- Measuring tape – Imperial measurement units (Tiles are made to Imperial measurements)
- Felt-tip marker/paint marker to mark tiles for cutting (Sharpie™ – metallic silver or equal)
- Chalk line & refill bottle (black is permanent)
- String line
- Heavy-duty auto-lock cutter utility knife (Olfa LA-X™ or equal) & replacement blades (LBB UltraMax™ or equal)
- Jigsaw (Bosch or equal – minimum 5.5 amp or greater recommended)
- Jigsaw blades; 10 teeth per inch minimum – Should be not any longer than 1/4" shorter than the thickness of tile (in saw and when extended)

- Templates – for marking postholes for cutting
- Polyurethane expansion foam
- Duct or masking tape to protect adjacent items during adhesive application
- Disposable rags and/or paper towels (adhesive clean up)
- Goof Off® (red can), made by Valspar
- Cordless 18V Albion deluxe adhesive dispenser for 20 oz. sausage tube for tile-to-tile adhesive – part No. 1007-1E(SOF)
 - sofSURFACES custom nozzle for adhesive injection
 - Recommend an additional dispenser
- Single barrel manual caulking gun for 20 oz. (by volume) tubes to dispense adhesive (Albion™ DL-45-T18 with Hytrel plastic piston)
 - Cone nozzles
- V-notched trowel with 1/8" square notch or 3/16" v-notch – plastic or metal trowel – for tile to base adhesive spreading
- 8 lb. sledgehammer
- Pipe Fittings (3/8"), for glue gun

Personal protective equipment

- Disposable protective gloves (latex, nitrile or other) – for adhesive application
- Gloves (general work gloves)
- Safety glasses
- Hard hat
- Knee pads

Optional equipment

- Vacuum cleaner
- Hot box – for heating of adhesive
- Flex curve carpenter

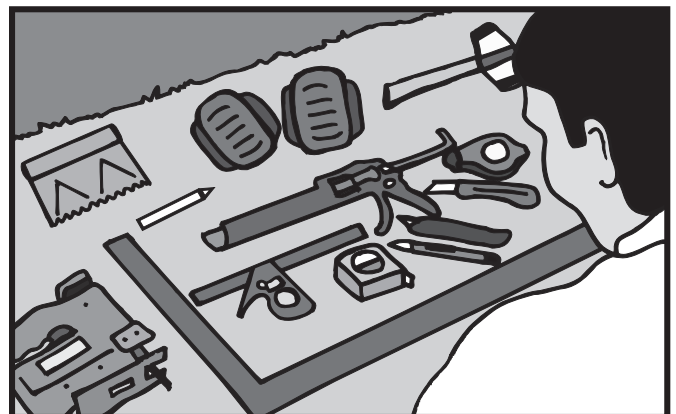

SITE SURVEY

DRAINAGE IS REQUIRED

Note: Insufficient drainage will result in the duraSTRONG surface being subjected to standing water for long periods of time. Standing water will damage the duraSTRONG surface and void the limited lifetime warranty.

Note: A properly designed and installed water collection system is often overlooked during duraSTRONG site planning stages. Although the tiles are impervious, water will pass through the corners and seams of the duraSTRONG system. It is critical that a proper subsurface drainage system be installed.

Note: The installation techniques outlined in the following sections are mandatory to ensure the surface has been installed to specification and to validate the lifetime warranty.

In some instances additional surface water drainage is required and tiles may require holes drilled through them. Drill holes between the pedestals approximately a 1/2" in diameter. Holes do allow for dirt access. Tiles with drilled holes in them are not covered by the replacement lifetime warranty.

A – Locate the Center Line of the Area

Locate, measure and chalk line the vertical and horizontal center lines in the area. Center lines should be shifted based on the best visual effect on the perimeter cuts.

THE LAYOUT

When preparing the initial site layout there are important factors to take into consideration:

- Each duraSTRONG tile is manufactured to a nominal dimension of 24.25" (+/- 1/8") x 24.25" (+/- 1/8") from the factory
- The duraSTRONG installation process requires that each tile be installed under compression to a finished dimension of 24"
- A site typically requires fixed edges. This may take the form of buildings, sidewalks, plant boxes, glued-down sofRAMPS®, etc. (See Fig. 12a, b, c on page 11).
- It is unlikely that the site is perfectly square or exactly as shown in the drawings
- The glueless duraSTRONG installation method requires that all perimeter tiles be cut in at the beginning of the installation.

To ensure a visually proportionate site, lay the surface out with similar dimension cuts on all four sides of the area. **When possible, perimeter cut tiles should be a minimum of 10 inch in width. Check the prepared site tile layout drawing.**

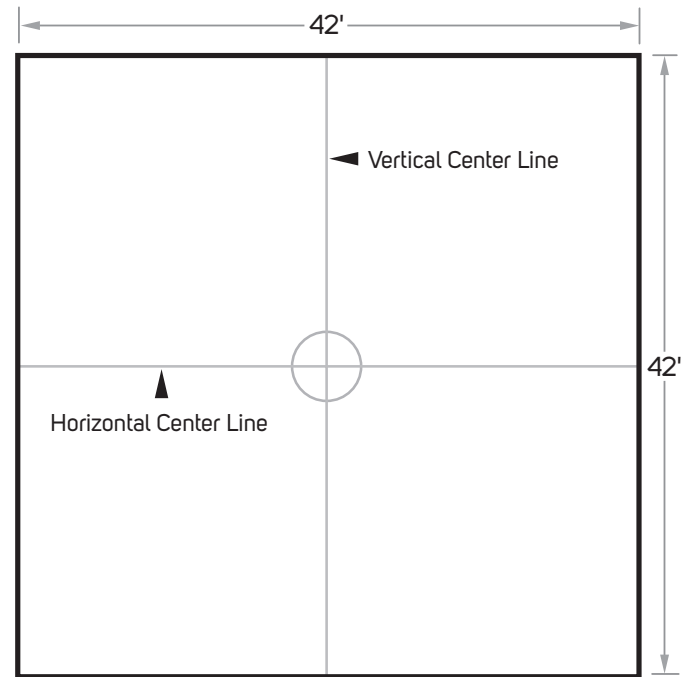

Fig. 1

INSTALLATION METHOD ONE –

Partial Glue Down Method

(Applications Larger Than 2,000 sq.ft.)

Each duraSTRONG tile measures approximately 24.25" (+/- 1/8") x 24.25" (+/- 1/8") from the factory.

Once installed under compression, tiles **must measure 24" X 24"** meaning each tile must be compressed by a minimum of 1/4".

Since each individual duraSTRONG tile must be compressed by 1/4", the cumulative compression over a large area can best be achieved by breaking the total area into smaller more workable grid sections.

The following guidelines have been prepared to ensure that your large installation is properly compressed using a minimal amount of effort. This advanced installation technique will introduce new terminology and concepts involving the use of keystone tiles, strategic rows of tiles and compression rows.

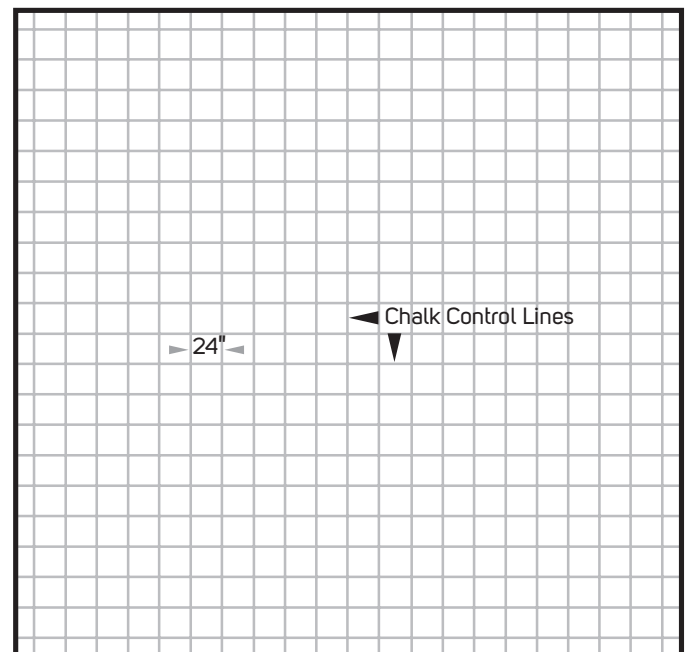

Fig. 2

B – Striking Lines

From the center point in the area, strike chalk lines in 24" increments across the area in both directions so that a grid pattern has been created across the entire area (**Fig. 2**).

C – Install Keystone Tiles

Tiles that are permanently fastened to the subsurface in strategic locations throughout the installation are referred to as keystone tiles. Keystone tiles are fastened to the sub-surface using tile-to-base adhesive supplied with the order. See **adhesive section** at the back of the book for detailed instructions. The purpose of keystone tiles is to provide a fixed point of compression for the strategic tile rows.

Using the tile-to-base adhesive methods on **page 9**, adhere keystone tiles in each of the four corners of the installation. Since perimeter cuts can be placed last, each keystone tile should represent a full tile (**Fig. 3**).

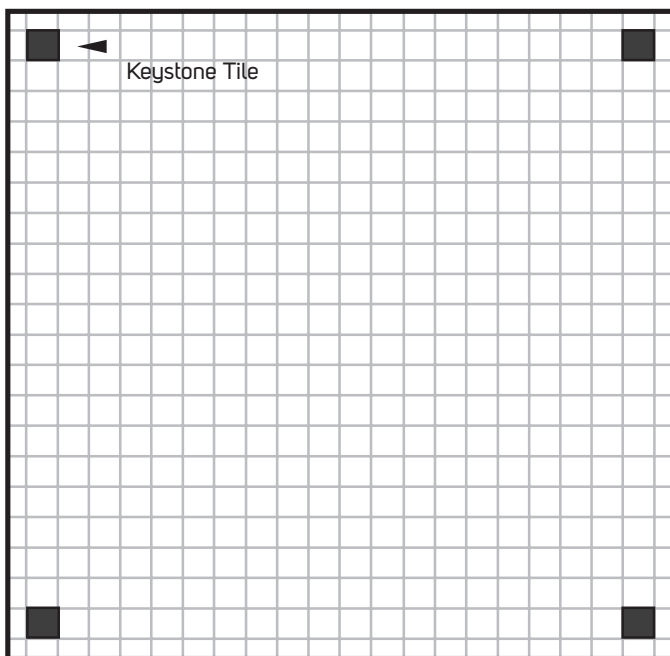

Fig. 3

Continue to place and secure keystone tiles every 7th tile throughout the installation (6 tile spaces between keystone tiles) (**Fig. 4**).

Note: Keystone tile tile-to-base adhesive must cure enough to prohibit movement before strategic tiles rows are placed. Average set time is 4 hours based on temperature and humidity.

D – Install Strategic Tile Rows

Strategic rows of tiles are compressed between the keystone tiles. Installation of strategic rows assists in breaking large sites into smaller areas that are much easier to compress into place.

- Begin by trowelling the factory supplied tile-to-base adhesive in a 12" x 12" square centered where each tile will be placed. See adhesive instructions beginning on **page 9**.
- Install strategic rows of tiles beginning at opposite ends of the keystone tiles working inwards towards the center (**Fig. 5**).

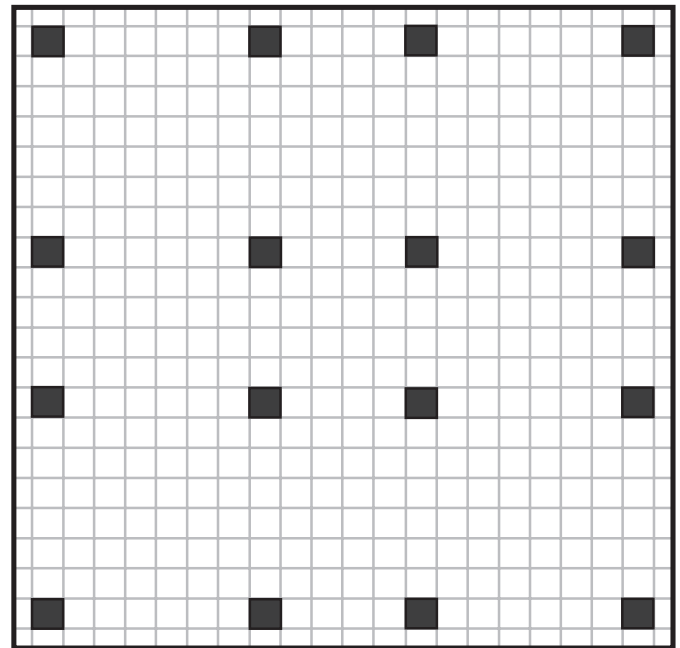

Fig. 4

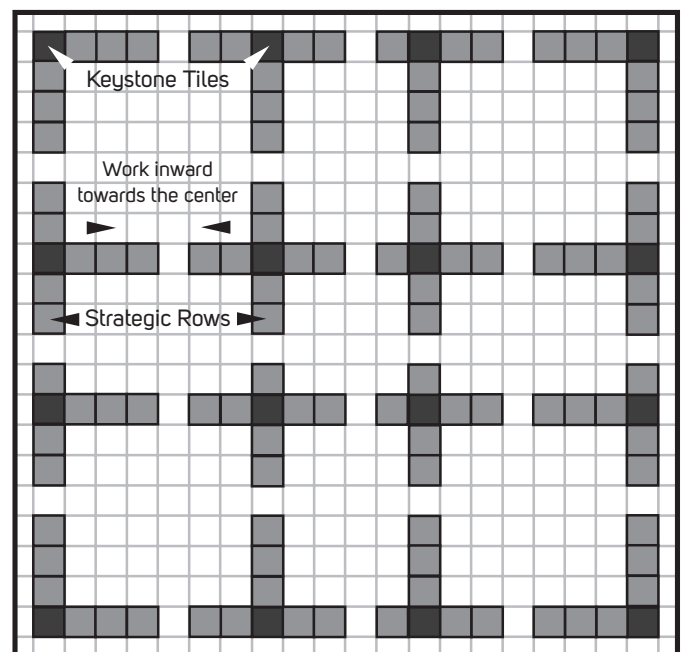
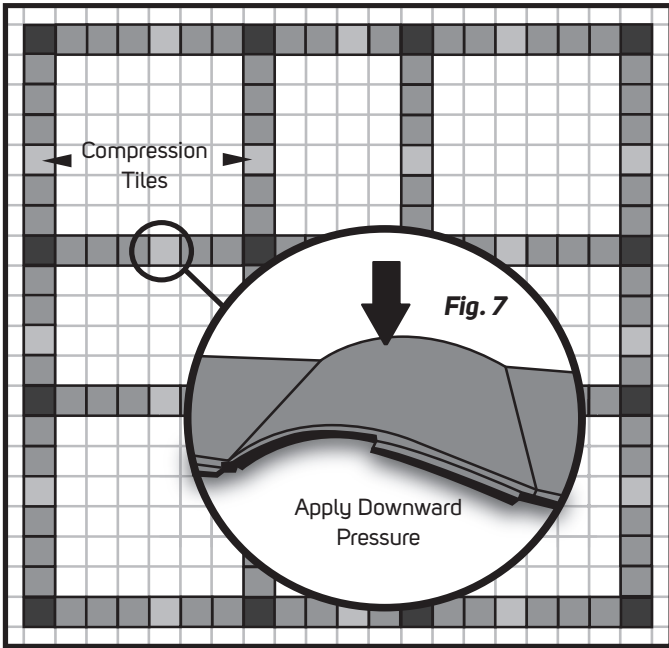

Fig. 5

- The final tile located in the middle of the strategic row is the compression tile and must be compressed into a space smaller than the tile. The process of compressing the tile into this space will force the other tiles to compress in each direction (**Fig. 6**).
- The locking mechanism on each edge of the tile should be engaged with the adjacent tile forcing the tile to buckle upwards. Once the locks are engaged, force the tile flat by applying downward pressure onto the tile (**Fig. 7**).
- The tile must be compressed into each strategic row within the tile-to-base adhesive working time to ensure the tiles are able to move before the tile-to-base adhesive cures.



E – Install Compression Rows

Fig. 6

Compression rows are defined as the rows of tiles installed in the center of the strategic rows forming a cross hair in the center of each grid. Compression rows are installed before the remaining field tiles are installed. Compression rows of tiles are not adhered to the floor. Compression rows must be installed after the strategic row tile-to-base adhesive has cured (**Fig. 8**).

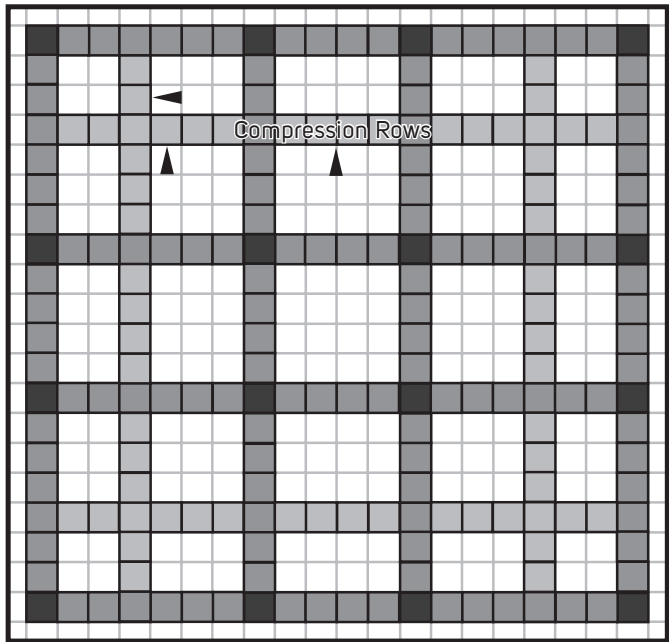

Fig. 8

F – Installing Field Tiles

The remaining tiles to be installed are referred to as the field tiles. Install field tiles according to the diagram shown in **Fig. 9**

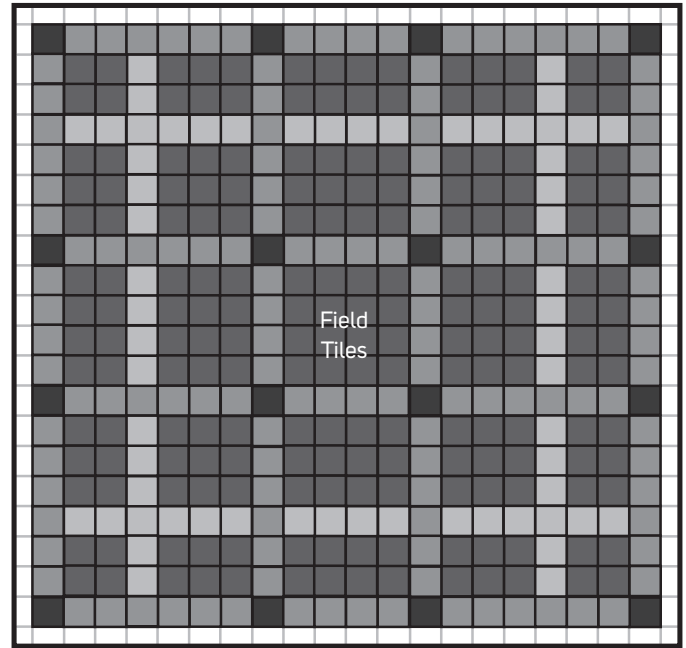

Fig. 9

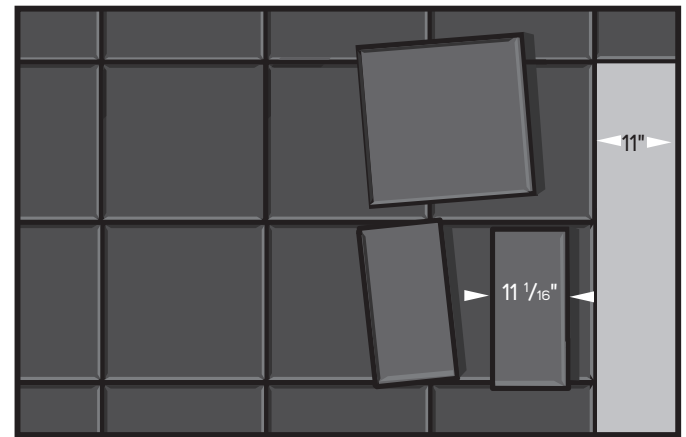

Fig. 10

G – Cutting in the Perimeter

(See **page 11** for additional edge details)

At each seam location along the chalk line around the perimeter of the area, measure the distance from the perimeter tile edge to the wall and add $\frac{1}{16}$ " to this measurement. Transfer these measurements onto the tile (**Fig. 10**).

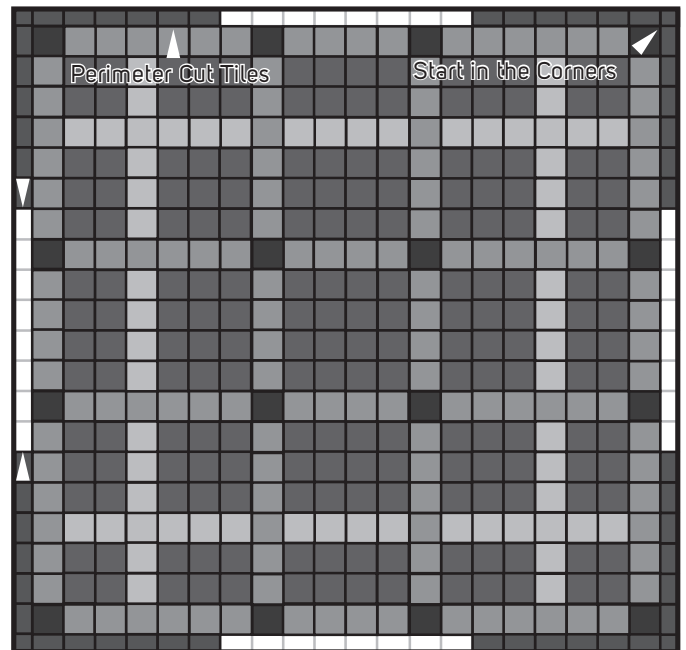

Fig. 11

Cut tiles with a razor blade knife and metal straight edge on the line but with a back-cut or under-cut of approximately 5 degrees. Install the cut tiles all the way around the perimeter. Start at the corners and work around (**Fig. 11**).

H – Transitional Ramp Installation (See Fig. 12a on page 11). If transitional ramps are being utilized on one or more sides they must be permanently secured to the sub-surface using the following adhesive application method.

ADHESIVE INSTRUCTIONS

Depending on the size and scope of your project different adhesives may be supplied with the order:

- Seam adhesive is supplied for installations that require less than 2 gallons of adhesive. Seam adhesive is supplied in 600 ml sausage tube format and will need to be dispensed using the adhesive gun supplied with the order.
- Tile-to-base adhesive is supplied on installations that require more than 2 gallons of adhesive. Tile-to-base is supplied in 4 gallon pails.

The glueless method was developed for installations where you are unable to glue to the sub-surface. Please check with the manufacturer or supplier of the roofing membrane for approval to install tiles with or without a protective layer.

Each duaSTRONG tile measures approximately 24.25" (+/- 1/8") x 24.25" (+/- 1/8") from the factory.

After they are installed under compression **must measure 24" X 24"** meaning each tile must be compressed by a minimum of 1/4".

Transitional Ramp Adhesion

Prior to beginning the adhesive application process, measurements should be verified to ensure that the transitional edge pieces are placed in the exact position required based on the compression table and floor layout.

Adhere transition pieces by placing the manufacturer supplied tile-to-base adhesive between the transition edge and sub-floor. If using seam adhesive, begin by dispensing several large beads of seam adhesive from the tube onto the subsurface.

Finish the adhesive application using a 1/8" square notched trowel to obtain 100% coverage.

Once the transition ramp has been placed over the adhesive, it should be allowed to fully cure before any compressive force is placed on it.

Recommended Trowels for Maximum Performance

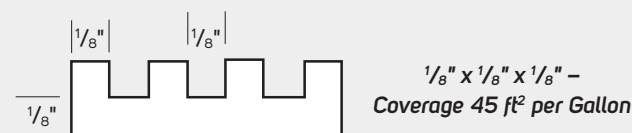

- Trowel size is suggested to maximize coverage of adhesive. Periodically check coverage of adhesive during installation. Uneven surfaces may require the use of either a leveling/patching material, or a larger notched trowel for proper coverage of adhesive.

Keystone and Strategic Tile Row Adhesion

Prior to adhering any tiles, check the drawing to ensure that the installed tiles represent the intended design.

Ensure that the control lines have been properly marked based on the attached compression chart.

Trowel the factory supplied tile-to-base adhesive in a 12" square, centered within the gridline location that will receive the tile. Only the 12" square in the center of the tile areas are to receive tile-to-base adhesive as shown in (**Fig. 12**).

Apply tile-to-base adhesive using a 1/8" square notched trowel. Apply adhesive in increments covering only the areas that will receive tiles within 15 minutes of adhesive application.

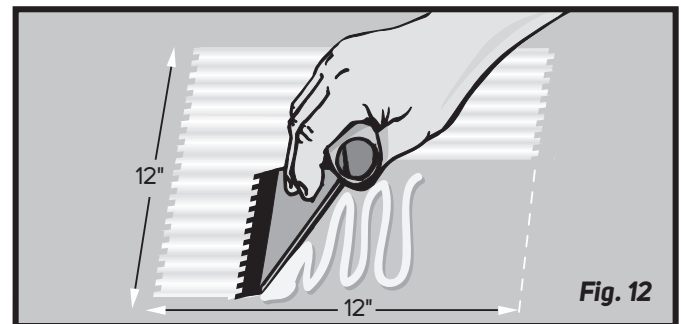

Note: The tile-to-base adhesive placed under keystone and strategic tiles must cure before compressive forces are applied.

INSTALLATION METHOD TWO – Glueless Method

A – Locate the Center Line of the Area

Locate, measure and chalk line the vertical and horizontal center lines in the area. Center lines should be shifted based on the best visual effect on the perimeter cuts. When possible perimeter cuts should be a minimum of 10" in width (**Fig. 1**).

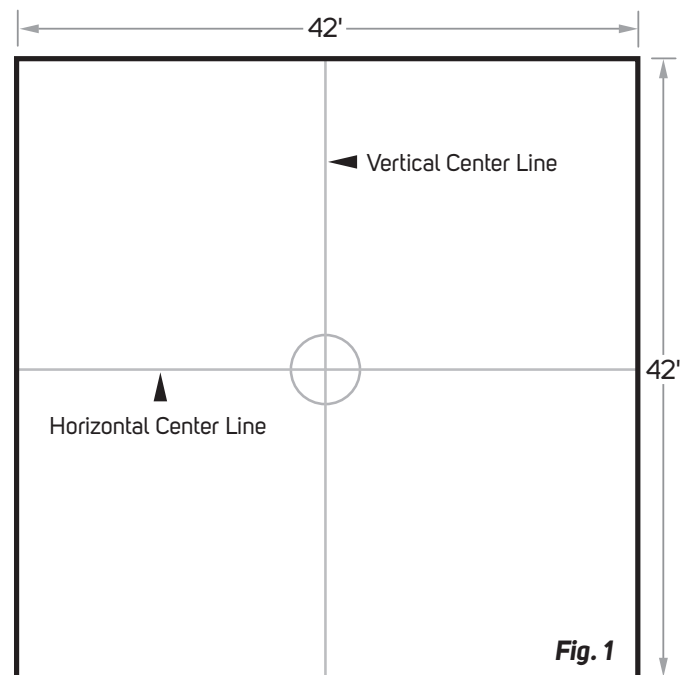

B – Striking Lines

From the center point of the area strike chalk lines in 24" increments across the area in both directions so that a grid pattern has been created across the entire area (**Fig. 2**).

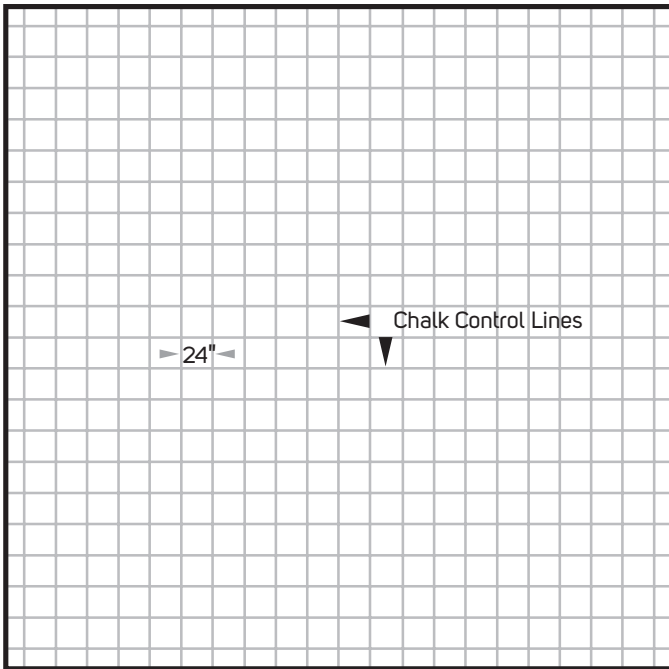

Fig. 2

C – Cutting in the Perimeter

In order to properly compress all of the field tiles, the perimeter of the area must be cut in and placed first.

At each seam location along the chalk line around the perimeter of the area, measure the distance from the line to the wall and add $\frac{1}{16}$ " to this measurement and write that dimension on the floor.

Continue this process at every seam around the perimeter of the area (every 24").

Transfer these measurement onto the tile.

Cut tiles with a razor blade knife and metal straight edge on the line but with a back-cut or under cut of approximately 5 degrees. Install the cut tiles all the way around the perimeter. Start at the corners and work around the area.

Perimeter tiles should be installed in 6 tile increments leaving a one tile space between each 6 tile row. This is done to make compression easier by balancing the compressive forces throughout the floor (**Fig. 3**).

Compress the final perimeter tiles into the remaining voids (*see 'G – Installing Field Tiles in the Opposite Direction' for further details*).

D – Transitional Ramp Installation

If transitional ramps are being used on one or more sides they must be permanently secured to the floor in order to provide a fixed point of compression for the field tiles. Prior to the installation of field tiles, locate the final position of the transitional ramps based on the attached **Compression**

Chart and fix them in place with the tile-to-base adhesive supplied with the order. Adhesive must be fully cured before compression can be applied to the transitional edge (*see adhesive instructions for additional information*).

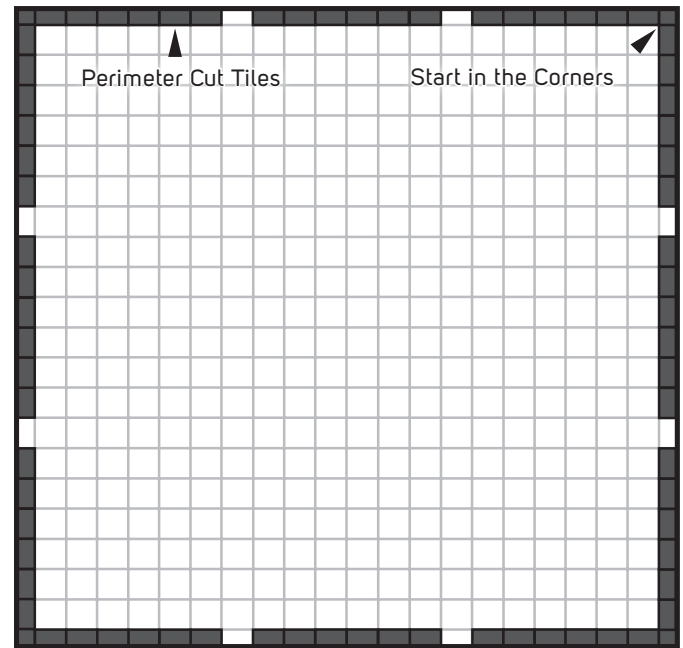

Fig. 3

E – Installing Field Tiles

Install the field tiles running in one direction only across the area.

Install every other row of tiles only beginning at the perimeter cuts at each end of the area.

Tile rows should be installed in approx. 6 tile increments leaving a one tile space between each 6 tile row. The number of tiles between spaces may need to be adjusted based on the area dimensions. (**Fig. 4**).

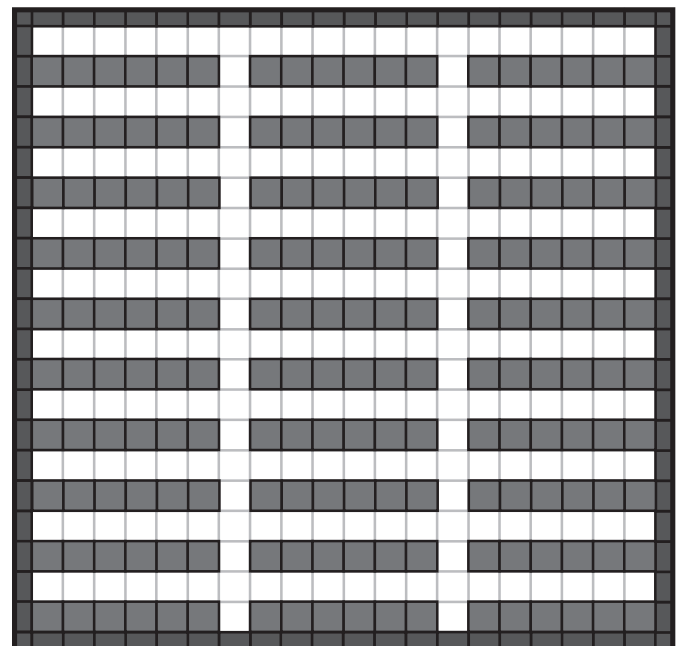
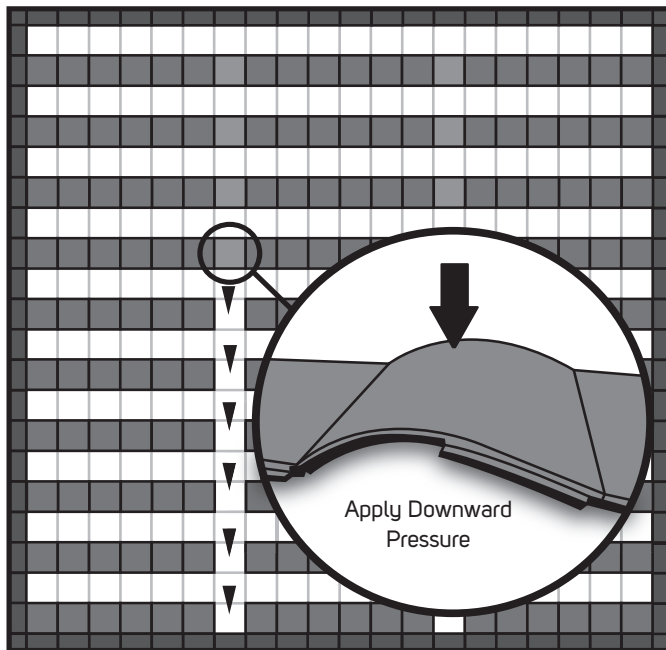

Fig. 4

F – Installing Compression Tiles

Begin installing the tiles in the empty space located between the 6 tile increments. These tiles represent the compression tiles and will need to be compressed into a space smaller than the tile (**Fig. 5**).

The locking mechanism on each edge of the tile should be engaged with the adjacent tile forcing the tile to buckle upwards. Once the locks are engaged, force the tile flat by applying downward pressure onto the tile. This is normally done using a kicking motion or a sledge hammer.



INSTALL COMPRESSION TILES

Fig. 5

Note: The process of compressing a tile between rows will force the other tiles to compress and shift in opposite directions. In order to create equal compression across the floor and to minimize shifting during installation, certain tiles must be temporarily weighted down prior to the compression process. Place 5 or 6 tiles on top of each 6 tile row close to the center point (**Fig. 6**). Once the compression tiles have been installed, the tiles used as weight tiles can be shifted to the next row of tiles.

Alternately, if the size of the installation crew permits, standing at the center point of the 6 tile rows during compression will achieve the same effect.

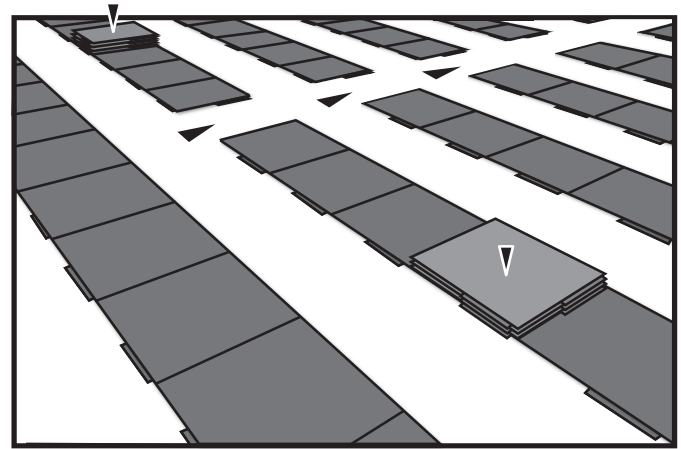
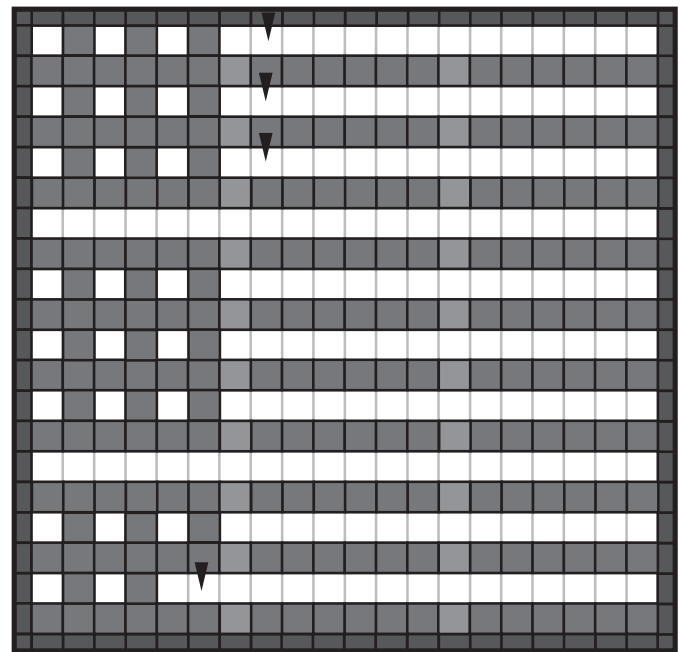

Fig. 6



INSTALL FIELD TILES IN OPPOSITE DIRECTION Fig. 7

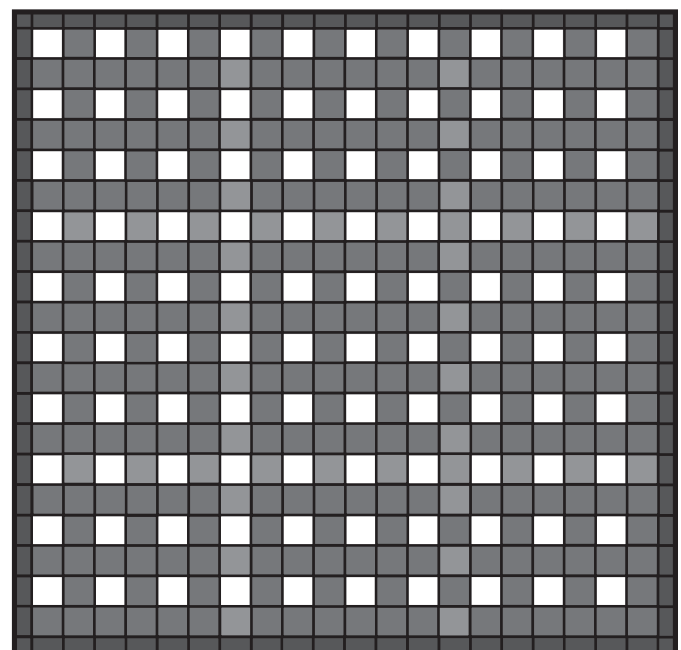

Fig. 8

G – Installing Field Tiles in the Opposite Direction

Once every other row of tile has been installed and compressed into place, begin installing every other row of tile in the opposite direction (**Fig. 7**), using the same process as described in **Section 'F'**.

H – Install Compression Tiles

Install the compression tiles in between the 6 tiles increments in the same manner described in **Section 'F'**. Minimize shifting by applying weight to tiles as described in **Section F**.

I – Placing Final Compression

At this point in the installation your tile layout should look like the drawing shown in **Fig. 8**.

The remaining spaces in the floor are smaller than the tiles that will be placed and therefore each tile must be forced into place. The process of forcing each remaining tile into place will compress all of the remaining tiles in opposite directions.

STEP ONE

Begin by engaging the locks in each of the four corners with the tiles adjacent. This process will create significant pressure and will cause the compression tile to balloon (**Fig. 9**).

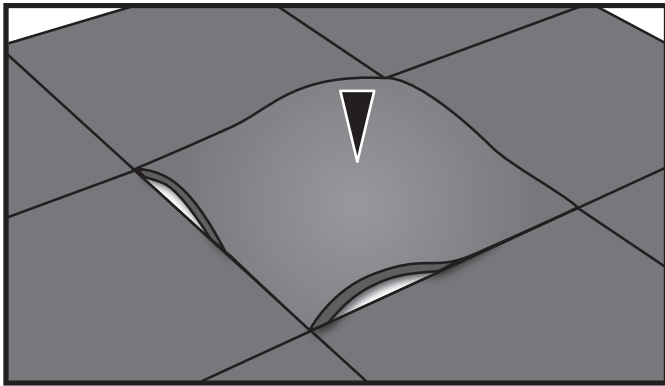

Fig. 9

Starting on the outer perimeter rows, continue to engage the four corners of each compression tile without attempting to compress the tiles (**Fig. 10**).

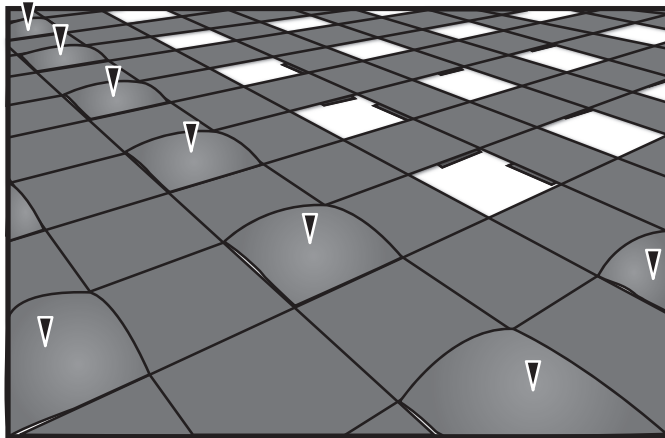

Fig. 10

STEP TWO

Once all of the tiles around the perimeter have been partially installed by engaging the corners, begin compressing the tiles into place. Compressing the tiles can be labor intensive and is best accomplished by applying considerable downward force through a kicking action and the use of a sledge hammer.

Continue this process throughout the area using the two step method above. Install final compression tiles in large groups at a time, beginning with the one or two rows around the perimeter and then working throughout the surface area (**Fig. 11**).

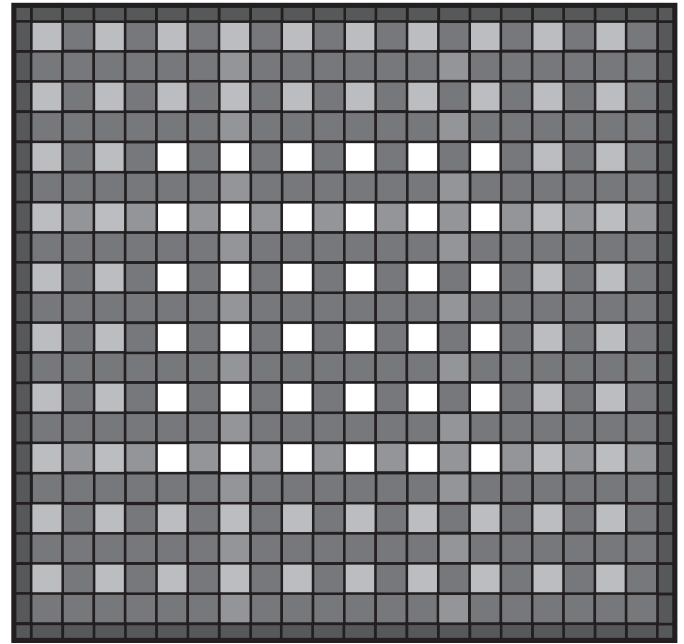

Fig. 11

Compress tiles throughout the remainder of the area based on how the tiles are shifting during installation.

CUTTING TILES

Most straight cuts can be made with a utility knife. When using a utility knife place the tile on a level surface and score the area to be cut with an initial pass of the knife. Once the score has been made, apply pressure to the tile to open the score. Placing the tile over a 2x4 or allowing the edge of the tile to hang over a table top will assist in opening the score. Opening the score of the tile reduces friction between the tile and the knife making the cut much easier. Continue making passes with the knife working your way through the tile.

A jigsaw can also be used to make straight and irregular cuts. When using a jigsaw, always score the tile with a utility knife or circular saw first.

All cutting should be done in a 15-20 degree back angle. Always use a jigsaw blade that is 1/4" shorter than the thickness of the tile.

It is easiest to cut tiles when the tile is laying flat on a stable surface.

Adhering Tiles

duraSTRONG's unique locking design provides a mechanical means of securing the system. The locking system, however, was engineered to be effective only when installed with the proper quantity and placement of seam adhesive.

Key points

- Proper application of seam adhesive to the KROSLOCK joint is critical to the overall performance of the duraSTRONG system and is mandatory for all outdoor applications.
- Using too little seam adhesive, or applying the seam adhesive in the incorrect location will result in failure of the locking system, and will void the lifetime warranty.

- Only use seam adhesive provided by or recommended by the manufacturer.
- Only use the application equipment provided by the manufacturer.
- Sealing the entire length of the seam will prevent damage caused by the migration of sand and other loose particles into the seams of the product.
- Surface temperatures above 40° F and rising are recommended. Avoid temperatures below 40° F and above 105° F.
- Surfaces must be clean and **completely free of moisture, morning dew, or frost.**
- Seam adhesive heated to 75-80°F.

1. Checklist prior to application

Prior to beginning the seam adhesive application process, the following checklist should be verified. Any corrections that need to be made will be much easier prior to the application of seam adhesive.

- Check your layout and the drawings to ensure that your installation represents the intended design, check that all of your rows are straight, and that all of the seams are properly aligned.
- Ensure that the surface has been compressed to the correct dimension.
- Make sure your perimeter and post cuts are tight and neat.
- Verify that the tiles are clean and dry.

2. Seam adhesive placement locations

Seam adhesive application methods vary slightly depending on the type of installation and the substrate that the system will be placed on. Regardless of the substrate used however, all duraSTRONG systems have minimum adhesive application requirements.

3. Tile-to-tile adhesion

Seam adhesive must be properly placed on the vertical wall of the interlocking joint and **NOT** in the bottom of the u-shaped locking system (**Fig. 10a**).

Placing the correct amount of seam adhesive onto the proper location of the product will ensure the long term success of the installation.

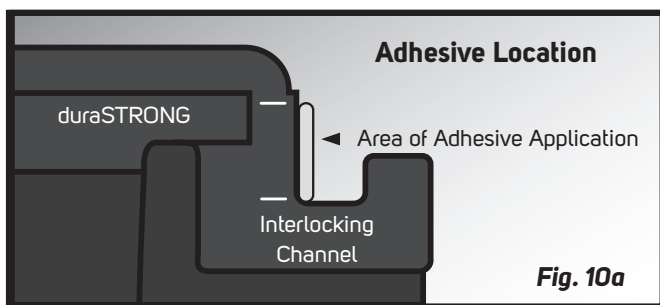

Fig. 10a

4. Preparing the equipment

In order to minimize any potential mess during seam adhesive application, a small set up area should be created using a piece of cardboard or other disposable covering material. Prior to beginning the seam adhesive

application process, make sure you have rubber gloves, rags, a knife and appropriate cleaning solutions for clean up purposes (**see page 1**).

- Open the dispensing unit by unscrewing the tip and cap.
- Pull the notched dispensing arm out to accommodate the seam adhesive tube.
- When inserting the seam adhesive tube, leave 3"-4" exposed.
- Using scissors or a knife cut the entire tip off the tube, and discard the end.
- Hold the dispensing unit upright to allow the tube to slide entirely into the unit.
- Assemble the tips and cap ensuring that they are tightly screwed into each other and the dispensing unit.

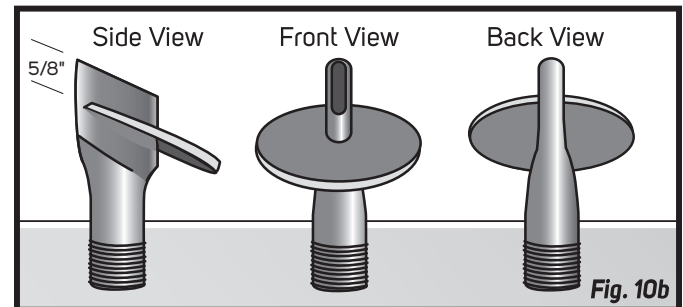

Fig. 10b

5. Application nozzles

You will notice that the seam adhesive application tip has been custom designed for use with the KROSLOCK system (**Fig. 10b**). The tip has been designed to control both the depth and placement of the seam adhesive. Although the tip has been designed to minimize seepage, careful attention must be paid to ensure that the correct amount of seam adhesive is being applied. Too little seam adhesive will affect the performance of the locking system. The correct amount of seam adhesive will rise to flush with the seam lines.

6. Seam adhesive application techniques

- Seam adhesive is to be heated to 75-80°F prior to use.
- Insert the custom applicator tip into the seam of the tiles until the depth guide (washer) comes in contact with the top of the tiles (**Fig. 10c**).
- Do NOT move tip until seam adhesive begins dispensing.
- Begin applying the seam adhesive between the tiles ensuring that the appropriate amount of seam adhesive is being applied to each tile. If seam adhesive begins to seep from the seams of the product adjustments will need to be made to your pressure and speed.
- The ideal quantity of seam adhesive will provide sufficient contact to both sides of the tile and will rise flush with the top of the seamline.
- As a general guideline select the 2.5 to 3.0 setting on the power dispenser and start with a travel speed of one tile length every 5 seconds.
- **Seam adhesive coverage must always be verified by measuring against the recommended coverage of 40 lineal feet per tube.**
- Since seam adhesive flow rates can be affected by temperature, adjustments to travel speed may be needed based on the actual seam adhesive coverage achieved.

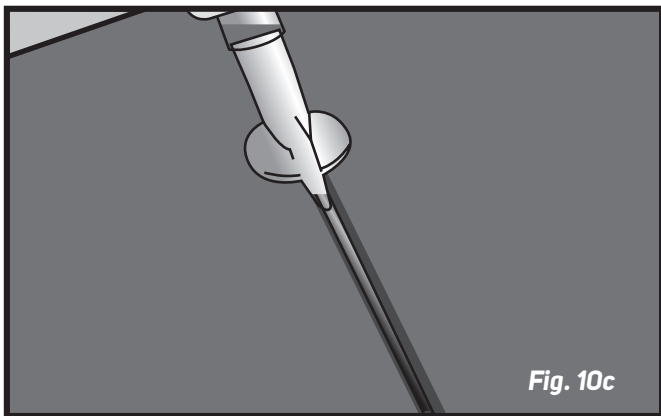

Fig. 10c

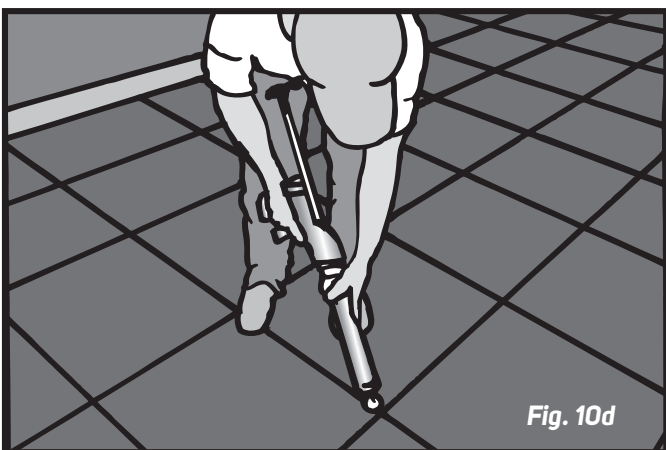

Fig. 10d

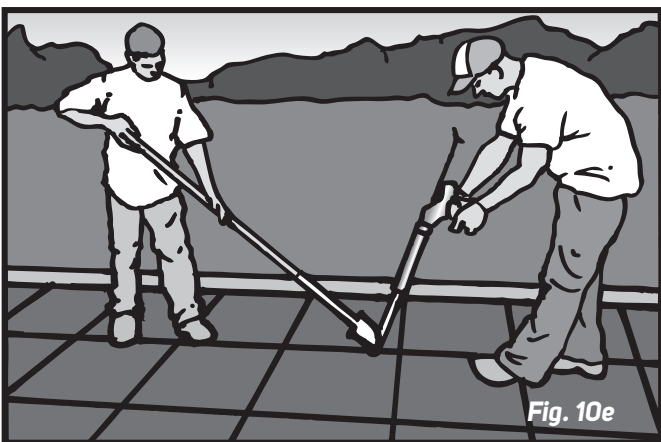

Fig. 10e

- Any excess seam adhesive should be left to fully cure prior to removal the following day. The excess seam adhesive can be quickly and neatly removed using a sharp razor knife.

Key Points

- When removing the tip from the seam be sure to have a rag available. Twist and wipe tip while removing.
- Apply seam adhesive to an entire row at a time, keeping track of the rows you have completed (chalk mark, etc.).
- **Always mark the last location where seam adhesive was placed prior to refilling seam adhesive gun.**

- To prevent blockage from cured seam adhesive, the application should take place in both directions representing the length and width of the site within a short time period of each other.
- Under no circumstances should a duraSTRONG system be installed outdoors without the use of seam adhesive.
- All seam adhesive supplied with the order should be completely consumed.

7. Transitional edging adhesion

When a sofRAMP transitional edge piece is used, seam adhesive must be placed both between the tile and sofRAMP, and between each sofRAMP edge using the applicator tip. Seam adhesive will also be placed between the sofRAMP and sub-surface using the manufacturer supplied subsurface tile-to-base adhesive and a notched trowel (**Fig. 11b**).

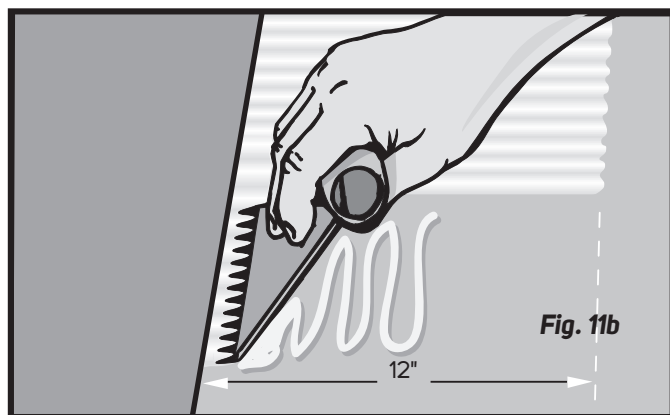

Fig. 11b

sofRAMP perimeter edging is adhered to the subsurface using the tile-to-base adhesive supplied with the order.

Care must be taken to ensure that the adhesive does not seep outside of the coverage area which in some cases may require taping.

sofRAMP perimeter edging is adhered to the tile using the same procedure as tile-to-tile adhesion (**Fig. 11c**).

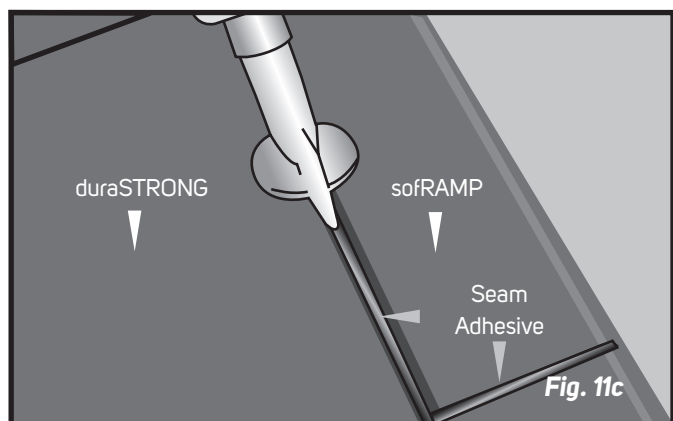

Fig. 11c

8. Post cuts

Seam adhesive must be applied to the initial straight cut leading into the circular cut (**Fig. 11d**).

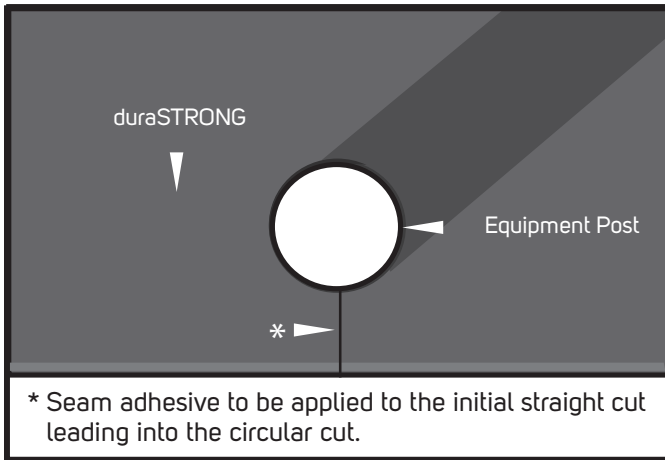
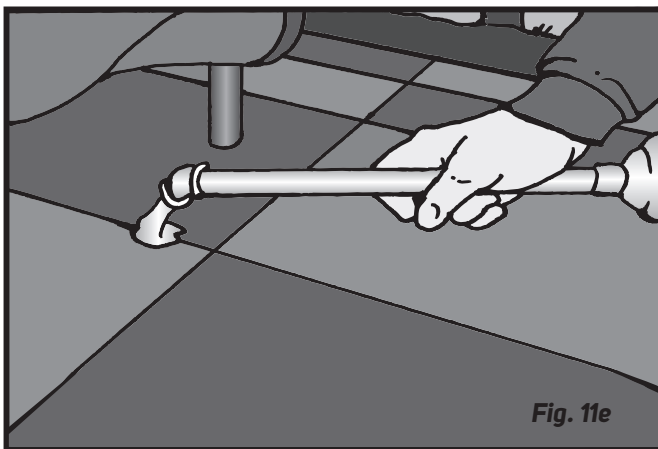

Fig. 11d

9. Adhesion under decks

Some areas of the site, such as under low elevation decks will be impossible to adhere using the applicator tip. In these instances, seam adhesive must be placed on the vertical wall of the locking joint prior to positioning the tile in place.



For most decks you can use a modified extension on the glue gun as shown in Fig. 11e.

10. Installation using a fixed edge

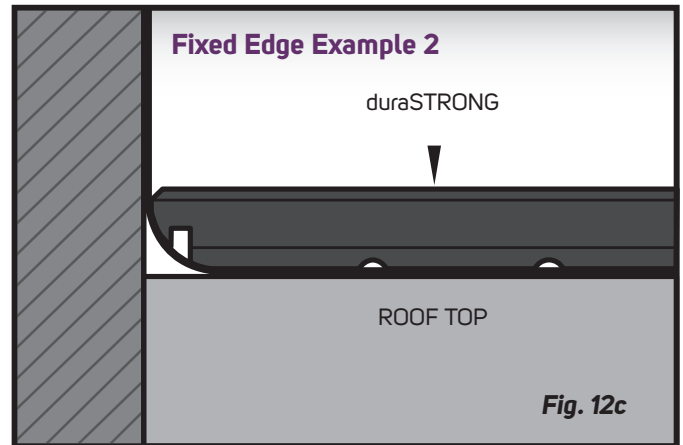
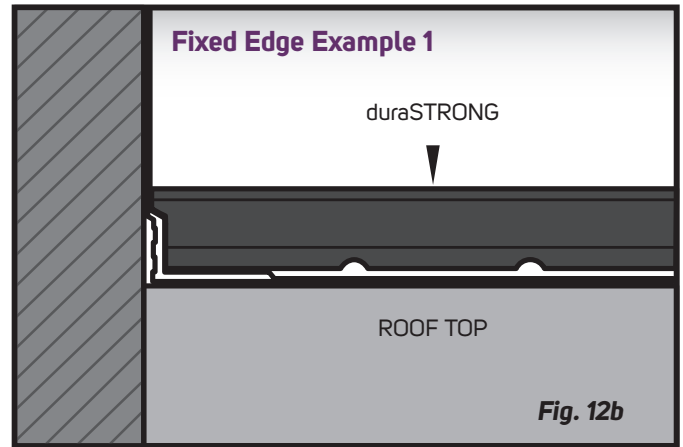
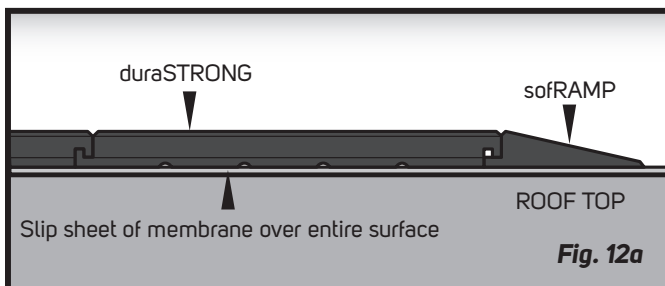

FINAL INSTALLATION DETAILS

1. Remove any adhesive spills

a) "Smearred" adhesive spill

If a small amount of adhesive is spilled onto the surface during installation, this can be removed immediately by wiping the spot with a rag containing a small amount of WD40, GoofOff (red can), or other suitable solvent. Use proper handling procedures. Try to "lift" the adhesive if possible from the surface.

b) "Bead-shaped" adhesive spill

If any seam adhesive inadvertently drips out of the end of the caulking tube onto the duraSTRONG surface, and this seam adhesive lies on the tile in a convex shaped bead, with extreme caution it can be lifted immediately (do not smear) with a cloth or knife. If unable to lift, it should be removed only after it has partially cured. The area will need to be protected so the area is not walked on. After curing you will need to use a knife to "scrape" the bead off of the tile.

2. Initial appearance and maintenance

Solid duraSTRONG colors will behave like new carpets when initially installed. The solid, brilliant colors will make the initial dust created by foot traffic very apparent. However, with time, the visible dust tracking will diminish.



INSTALLATION CERTIFICATE OF COMPLETION

Please send copy to sofSURFACES at 519.882.2697

Installation Completed By (check one):

sofSURFACES Dealer/Representative

Project Name: _____ Installation Dates: _____

Company Name: _____ Site Address: _____

Customer Name: _____

Customer Address: _____ Date of Completion: _____

Installation Company: _____

City: _____ State/Prov.: _____ Name of Crew Leader: _____
(please print)

Country: _____

Telephone: _____ Ext: _____ Signature: _____

I, the undersigned, hereby confirm that the work carried out by the aforementioned installer is complete and satisfactory.

Customer Signature: _____ Installation Manager: _____

Date of Customer Acceptance: _____

Comments: _____

- ▶ Include list of all installation team members on site
- ▶ Include photos of before, during, and after installation
- ▶ Record any site issues and how they were resolved

INSTALLATION AGREEMENT

I, _____ / _____
Signature Print Name

with _____
Company Name

have read the installation instructions and have installed the duraSTRONG tiles under compression as explained in the instructions and compression table. I understand that after the job is completed a measurement will be taken on-site to verify that proper compression was achieved. I further understand that if this floor is not installed correctly by my installers under the specified compression that it will void the customer's Limited Lifetime Warranty, and I or the company I represent shall be liable for any expenses associated with repairing the installation.

This form must be completed and signed by all parties and submitted WITH Installation Warranty form in order to activate the Limited Lifetime Warranty.



3. Initial odor

The polyurethane used to bind the rubber granules is 100% inert and odorless after it has fully cured. Full curing can take up to several days depending on atmospheric temperature and moisture. The odor may take longer to dissipate on indoor applications because of the confined area. The rubber may also have an odor.

4. Sealant

It is sofSURFACES' recommendation not to apply sealants to any duraSTRONG surface. However should you have any questions about sealing or coating the surface of the duraSTRONG product please contact our office.

ROUTINE MAINTENANCE

1. Routine maintenance extends life and enhances appearance

Like any surface, a good routine maintenance program will enhance the longevity and appearance of the duraSTRONG surface.

2. Regular cleaning

Sweeping or blowing the surface off with a leaf blower should be done regularly to ensure that abrasive materials, such as sand, are removed from the duraSTRONG surface.

3. Vacuum

Periodic vacuuming is recommended in areas where sand is frequently tracked onto the surface.

4. Cleaning agents

duraSTRONG can accommodate moderate use of most household or commercial cleaners that contain both odor suppressants and disinfectants. Dilute this cleaning agent as recommended by the manufacturer. Apply to the surface using a mop or scrubbing device. This will remove most light stains. Use only pH neutral based cleaning agents that do not contain bleach, or citrus.

ADVANCED MAINTENANCE

Depending on frequency of use, duraSTRONG will occasionally need a "deep clean" to remove built up dirt and stains.

1. Steam vacuum

A steam vacuum with or without cleaning agents is ideal for advanced cleaning and maintenance. Follow instructions.

2. Power washing

In areas that can accommodate power washing, use a power washer with a wand tip. Wand tip should be kept a minimum of 8" from the surface to prevent damage.

SUMMARY

- Proper application and quantity of seam adhesive to the KROSLOCK joint is critical to the overall performance of the surfacing system.
- Only use adhesive provided by or recommended by the manufacturer.
- Protective gloves should be worn to prevent skin contact.
- Take caution to ensure that adhesive is not spilled on adjacent surfaces.
- All adhesive supplied with the order should be completely consumed at the end of the installation.

Closing Statement

The entire sofSURFACES' team wishes to thank you for your careful consideration and decision to purchase a duraSTRONG system. Your investment in a duraSTRONG system is a wise one.

We work hard to produce the highest quality products and our dedication to customer service does not end with the sale of our surfacing. As industry leaders we are committed to the long-term success of your project.

**WE ARE AVAILABLE BY PHONE
AT: 1-800-263-2363 E.S.T.
FROM 8:00 AM TO 5:00 PM
MONDAY THROUGH FRIDAY.**

dura **STRONG**™
RUBBER PAVING TILES



Head Office

4393 Discovery Line
P.O. Box 239
Petrolia ON NON 1R0

1.800.263.2363
sofSURFACES.com

European Office

Kennemerstraatweg 464
1851 NG HEILOO
The Netherlands

+31 (6) 23730787
sofSURFACES.eu

