



Index

A

Abraham Knife 25-3
 Adenoid Curettes 23-46 - 23-48
 Adenotomes 23-48
 Andrew Tongue Depressor 24-9
 Antrum Punch Forceps 23-17 - 23-19
 Antrum Rasps 23-33
 Asch Septum Forcep 23-44
 Aufricht Glabella Rasp 23-33
 Aufricht Nasal Retractor 23-40, 23-42
 Awis 24-19

B

Ballenger Septal Knife 23-21
 Ballenger Septum Gouge 23-27
 Barbara Ear Needle 22-10, 22-11
 Barnhill Adenoid Curette 23-47
 Baron (Schuknecht) Suction Tube 22-17
 Barth Ear Spoon 22-33
 Beckmann Adenoid Curette 23-46
 Beckmann Nasal Speculum 23-3, 23-6
 Belluci Micro Ear Scissor 22-5
 Beyer Ear Punch 22-31
 Billeau Ear Loop 22-34
 Bishop Tongue Depressor 24-8
 Blohmke Tonsil Seizing Forcep 25-7
 Boies Rhinoplastic Instrument 23-16
 Bone Files 23-33
 Boucheron Ear Speculum 22-19
 Broncho-Esophagoscopy Forceps 25-11
 Bruenings Cutting Forcep Tip 25-13
 Bruenings Septal Knife 23-21
 Bruenings Septum Compression Forcep 23-10
 Bruenings Tongue Depressor 24-11
 Bruenings Tonsil Snare 25-8
 Bruenings Universal Handle 25-12
 Buchwald Tongue Depressor 24-11
 Buck Ear Curette 22-32, 22-33
 Buck Foreign Body Lever 22-29
 Buck Paracentesis Needle 22-36
 Buckingham Foot Plate Instrument 22-13

C

Canfield Knife 25-3
 Caplan Septum Scissor 23-15
 Carpenter Tonsil Knife 25-4
 Cawfood Retractor 24-12
 Cheek-Lip Retractors 24-7 - 24-9
 Chevalier-Jackson Broncho-Esophagoscopy Forcep 25-11
 Chin Retractors and Channelled Retractors 24-16
 Chisel Maxillo-Facial Surgery 24-18
 Chisels 23-29, 23-31
 Cinelli Chisel 23-29
 Citelli Ear Punch 22-31
 Cleft Plate Needles 25-2
 Coakley Curette 23-45
 Collin Tongue Holding Forcep 24-13
 Colver Tonsil Seizing Forcep 25-7
 Converse Chisel 23-31
 Converse Mucosa Hooklet 23-40
 Converse Nasal Rasp 23-35

Converse Rhinoplastic and Nasal Knife 23-20
 Cordes Cutting Forcep Tip 25-13
 Corwin Tonsil Hemostats 25-10
 Cottle (Collumella) Skin Grasping Forcep 23-43
 Cottle Cartilage Crusher 23-32
 Cottle Guide Support for Osteotomes 23-32
 Cottle Handle 23-32
 Cottle Mucosa Hooklet 23-40, 23-41
 Cottle Nasal Rasp 23-33
 Cottle Nasal Retractor 23-42
 Cottle Nasal Speculum 23-4, 23-5
 Cottle Osteotome 23-28
 Cottle Rhinoplastcic and Nasal Knife 23-20
 Cottle Septum and Periosteal Elevator 23-24, 23-25
 Cottle Skin Grasping Forcep 23-43
 Cottle-Neivert Alar Hooklet 23-41
 Cottle-TC Nasal Rasp 23-39
 Cottle-Walsham Septum Forcep 23-44
 Crura and Malleus Nipper 22-7
 Curettes-Ear 22-12 - 22-38
 Curettes-Rhinology 23-45
 Cutting and Grasping Forceps Tips 25-13

D

Davis-Boyle Mouth Gag 24-4
 Day Ear Hook 22-35
 Denhart Mouth Gag 24-2
 Dingmann Mouth Gag 24-5
 Disimpaction Forceps 24-20
 Dissectors 25-4, 25-6
 Dissectors-Ear 22-12
 Douglas Knife 25-3
 Duplay Nasal Speculum 23-2
 Dupuy Weiss Tonsil Needle 25-2

E

Ear Dressing Forceps 22-28
 Ear Polypus Forcep 22-29, 22-30
 Ear Polypus Snares 22-27
 Ear Punches 22-31
 Ear Specula 22-18 - 22-20
 Ear Specula Holder 22-20
 Ear Syringe 22-40
 Eicken Killian Irrigation Cannula 23-49
 Elevators-Ear 22-12, 38, 39
 Endolaryngeal Micro Surgery Forcep 25-14
 Enucleators 25-4
 Epiglottis Retractors 25-18
 Eustachian Catheters 22-27
 Eves Tonsil Snare 25-8

F

Farrior Ear Speculum 22-19
 Faulkner Curette 23-45
 Ferris Smith Kerrison Antrum Punch Forcep 23-19
 Ferris-Smith-Kerrison (Cloward Harper) Antrum Punch Forcep 23-18
 Fisch Elevator 22-12
 Fisher Tonsil Knife 25-3
 Fomon Alar Hooklet 23-41
 Fomon Chisel 23-29
 Fomon Mucosa Hooklet 23-40



Fomon Nasal Rasp	23-34	Heymann Septum Compression Forcep	23-9
Fomon Rhinoplastic and Nasal Knife	23-20	Heymann-Knight Nasal Polypus Forcep	23-8
Fomon-TC Nasal Rasp	23-38	Hofer Tonsil Retractor	25-6
Foot Plate Hand Instruments	22-13	Hooklets-Ear	22-15, 22-35
Foot Plate Instruments acc to Heermann	22-14	Hooks-Ear	22-34
Forceps for Laryngo Bronchoscopy	25-15	House Dissector	22-12
Foreign Body Instruments	22-34	House Foot Plate Instrument	22-13
Foreign Body Levers	22-29	House Suction Tube	22-17
Fraenkel Grasping Forcep Tip	25-13	House-Dieter Crura and Malleus Nipper	22-7
Fraenkel Laryngeal Polypus Forcep	25-19	Huber Universal Handle	25-12
Freer Mucosa Hooklet	23-40	Hurd Cleft Plate Needle	25-2
Freer Rhinoplastic and Nasal Knife	23-22	Hurd Tonsil Dissector	25-4
Freer Septal Knife	23-21	J	
Freer Septum Chisel	23-26	Jansen Ear Dressing Forcep	22-28
Freer Septum Elevator	23-23	Jansen Ear Spoon	22-33
Freer Septum Gouge	23-26	Jansen-Middleton Septum Compression Forcep	23-14
French Tuning Fork	22-21	Jennings Mouth Gag	24-6
Frenzel Tongue Depressor	24-11	Joseph Bone File	23-33
Fuller Crura and Malleus Nipper	22-7	Joseph Mucosa Hooklet	23-40, 23-41
G		Joseph Nasal Saw	23-30
Gallaher Antrum Rasp	23-33	Joseph Rhinoplastic and Nasal Knife	23-20, 23-22
Gerzog-Sexton Paracentesis Needle	22-36	Joseph Septum and Periosteal Elevator	23-25
Glabella Rasps	23-33	Joseph Septum Elevator	23-23
Goldmann Rhinoplastic Instrument	23-16	Joseph-Masing Septum and Periosteal Elevator	23-25
Goldsmith Nasal Speculum	23-2	Juers Wire Closure Forcep	22-6
Graig Septum Compression Forcep	23-10	Jurasz Laryngeal Polypus Forcep	25-18
Graig-Domnick Septum Compression Forcep	23-10	K	
Greven Wire Closure Forcep	22-6	Kelsey-Fry Awis	24-19
Gross Ear Hook	22-34	Kerrison Antrum Punch Forcep	23-19
Gruber Ear Speculum	22-18	Killian Nasal Polypus Forcep	23-9
Gruenwald (Jansen) Nasal Dressing Forcep	23-8	Killian Nasal Speculum	23-3
Gruenwald Nasal Cutting Forcep	23-13	Killian Septum and Periosteal Elevator	23-24
Guilen Irrigation Cannula	23-49	Killian Septum Gouge	23-26
H		Killian Septum Scissor	23-15
Hajek Nasal Cutting Forcep	23-13	Killian-Claus Septum Gouge	23-26
Hajek-Claus Antrum Punch Forcep	23-19	Kilner Mucosa Hooklet	23-40
Hajek-Koffler Antrum Punch Forcep	23-17	Kilner-Doughty Mouth Gag	24-3
Halle Septum Elevator	23-23	Knight Septum Compression Forcep	23-9
Handle for Laryngeal Mirrors	25-17	Koenig Tuning Fork	22-26
Hartmann Ear Hook	22-34	Krause Cutting Forcep Tip	25-13
Hartmann Ear Polypus Forcep	22-29, 22-30	Krause Nasal Snare	23-7
Hartmann Ear Speculum	22-18	Krause Polypus Snare	22-27
Hartmann Eustachian Catheter	22-27	Krause-Voss Nasal Snare	23-7
Hartmann Nasal Cutting Forcep	23-13	Krause-Voss Polypus Snare	22-27
Hartmann Nasal Polypus Forcep	23-8, 23-9	Kressner Rhinoplastic Instrument	23-16
Hartmann Nasal Speculum	23-6	Kroenig Tongue Depressor	24-10
Hartmann Tongue Depressor	24-9	L	
Hartmann Tonsil Punch Forcep	25-10	La Force Adenotome	23-48
Hartmann Tuning Fork	22-21 - 22-25	Lange Grasping Forcep Tip	25-13
Hartmann-Halle Nasal Speculum	23-2	Lange Laryngeal Polypus Forcep	25-19
Hartmann-Hoffmann Ear Polypus Forcep	22-30	Lange Mucosa Hooklet	23-40
Hartmann-Noyes Ear Polypus Forcep	22-30	Langenbeck Ear Curette	22-32
Hartmann-Weingartner Ear Polypus Forcep	22-30	Lange-Wilde Nasal Snare	23-7
Hartmann-Wullstein Ear Polypus Forcep	22-30	Larkin Foot Plate Instrument	22-13
Haslinger Tonsil Retractor	25-6	Laryngeal Mirrors	25-16, 25-17
Hass Tongue Depressor	24-11	Laryngeal Polypus Forceps	25-18, 25-19
Heister Mouth Gag	24-2	Lempert Curette	22-38
Henke Enucleators	25-4	Lempert Elevator	22-38, 22-39



Lempert Raspatory	22-38	Nasal Snares	23-7
Lewis Nasal Rasp	23-33	Nasal Specula	23-2 - 23-6
Lewis-TC Nasal Rasp	23-39	Needles-Ear	22-10 - 22-16
Ligature Carriers	25-3	Negus Chest Support for Mouth Gag	24-5
Littauer Ear Polypus Forcep	22-29	Neivert Nasal Retractor	23-42
Littauer Nasal Polypus Forcep	23-9	Neivert Osteotome	23-31
Loops-Ear	22-34, 22-35	O	
Lopez-Reinke Tonsil Dissector	25-6	Obwegeser Awis	24-19
Love Tonsil Retractor	25-6	Obwegeser Chin and Channelled Retractor	24-16
Lubet-Barbon Nasal Polypus Forcep	23-8	Obwegeser Chisel	24-18
Luc Septum Compression Forcep	23-10	Obwegeser Osteotome Maxillo-Facial Surgery	24-18
Lucae Ear Dressing Forcep	22-28	Obwegeser Periosteal Elevator	24-17, 24-18
Lucae Ear Hook	22-35	Obwegeser Ramus Retractor	24-15
Lucae Paracentesis Needle	22-36	Obwegeser Soft Tissue Retractor	24-14
Lucae Tuning Fork	22-24, 22-25	Ogura Skin Grasping Forcep	23-43
Luniatschek Tonsil Packer	25-5	Oringer Cheek-Lip Retractor	24-7
M		Osteotome Maxillo-Facial Surgery	24-18
Maltz Nasal Rasp	23-33	Osteotomes	23-28 - 23-31
Maltz Rhinoplastic and Nasal Knife	23-22	P	
Maltz-T/C Nasal Rasp	23-37	Paracentesis Knife	22-37
Marschik Tonsil Forcep	25-5	Paracentesis Needles	22-36, 22-37
Masing Chisel	23-31	Pennington Septum and Periosteal Elevator	23-24
Masing Nasal Rasp	23-35	Periosteal Elevator	24-17, 24-18
Masing Rhinoplastic and Nasal Knife	23-20	Picks and Hooks	22-10, 22-11
Masing Septum and Periosteal Elevator	23-25	Pierce Septum and Periosteal Elevator	23-24
Mayo Tongue Depressor	24-10	Plester Ear Instrument	22-12
Mc Ivor Mouth Gag	24-4	Plester Micro Ear Knife	22-9
McGee Picks and Hooks	22-11	Politzer Ear Speculum	22-18
McGee Wire Closure Forcep	22-6	Politzer Paracentesis Needle	22-36, 22-37
McKenty Septum and Periosteal Elevator	23-24	Probes-Rhinology	23-49
McKenty Septum Elevator	23-23	Q	
Michel Laryngeal Mirror	25-17	Quire Foreign Body Lever	22-29
Micro Ear Forceps	22-2 - 22-8	Quire Nasal Polypus Forcep	23-9
Micro Ear Knives	22-9	R	
Micro Ear Scissors	22-5	Ramus Retractors	24-15
Micro Sinuscopy Forcep	23-55	Raspatories	22-38
Miller-Colburn Nasal Rasp	23-36	Reichert Epiglottis Retractor	25-18
Mini Mc Gee Alligator Forcep	22-2	Rhinoplastic and Nasal Knives	23-20 - 23-22
Minnesota Retractor	24-12	Rhinoplastic Instruments	23-16 - 23-44
Mobilizers-Ear	22-12	Richnau Holmgren Ear Speculum	22-20
Mod. Martin Cheek-Lip Retractor	24-8	Ritter-Halle Probe	23-49
Mod.Wien Nasal Speculum	23-3	Roder Ligature Carrier	25-3
Modell Wurzburg Tongue Plate for Mouth Gag	24-5	Roger Septum and Perisoteal Elevator	23-25
Moldenhauer Foreign Body Instrument	22-34	Rosen Curette	22-12
Molt Mouth Gag	24-2	Rosen Ear Needle	22-10, 22-11
Moritz-Schmidt Tongue Depressor	24-10	Rosen Elevator	22-12
Mouth Gags	24-2 - 24-6	Rosen Micro Ear Knife	22-9
Mucosa Hooklets	23-40, 23-41	Rosen Mobilizer	22-12
Museux Tonsil Seizing Forcep	25-7	Rosenberg Grasping Forcep Tip	25-13
Myles Nasal Cutting Forcep	23-13	Rosen-Konig Mouth Gag	24-2
N		Rowe Disimpaction Forcep	24-20
Nager Tonsil Retractor	25-5	Rubin Osteotome	23-29
Nasal Cutting Forcep	23-11 - 23-13	Rubin Septum Forcep	23-15
Nasal Dressing Forceps	23-8	Rubin-TC Septum Forcep	23-15
Nasal Polypus Forcep	23-8 - 23-10	Rydel-Seiffer Tuning Fork	22-26
Nasal Rasps	23-34 - 23-39	S	
Nasal Retractors	23-40, 23-42	Scheinmann Grasping Forcep Tip	25-13
Nasal Saws	23-30	Schmeden Nasal Cutting Forcep	23-13



Schuknecht Ear Needle	22-16	Tonsil Seizing Forceps	25-7
Schuknecht Micro Ear Knife	22-9	Tonsil Snares	25-8
Schuknecht Wire Closure Forcep	22-6	Tonsillectomes	25-9
Schumacher Cutting Forcep Tip	25-13	Toynbee Ear Speculum	22-18
Seemann-Seiffert Mouth Gag	24-6	Troeltsch (Wilde) Ear Dressing Forcep	22-28
Seiffert Grasping Forcep Tip	25-13	Troeltsch Nasal Dressing Forcep	23-8
Septum and Periosteal Elevator	23-24, 23-25	Tuding Tonsil Snare	25-8
Septum Chisels	23-26, 23-27	Tuning Forks	22-21 - 22-26
Septum Compression Frocep	23-9, 23-14	U	
Septum Elevators	23-23	Univ.Minnesota Tongue Depressor	24-10
Septum Forceps	23-15, 23-44	Universal Handles and Interchangeable Tubes	25-12
Septum Gouges	23-26, 23-27	V	
Septum Knives	23-21	Vetter-Ulrich Tonsil Hemostats	25-10
Septum Scissors	23-15	Voltolini Nasal Speculum	23-2
Sexton Paracentesis Needle	22-36	W	
Shambaugh-Derlacki Elevator	22-39	Wagener Ear Hook	22-35
Shapleigh Ear Curette	22-32	Walsham Septum Forcep	23-44
Shea Foot Plate Instrument	22-13	Walter Chisel	23-29
Sheehan Osteotome	23-29	Walter Osteotome	23-29
Siebenmann Wash Catheter	23-49	Wash Cannulas-Rhinology	23-49
Silver Osteotome	23-30	Wash Catheters-Rhinology	23-49
Simplex Cheek-Lip Retractor	24-8	Watson-Williams Nasal Cutting Forcep	23-11
Sinuscopy Forceps	23-50 - 23-56	Weil Nasal Cutting Forcep	23-11
Skin Grasping Forceps	23-43	Weil-Blakesley Nasal Cutting Forcep	23-12
Sluder-Ballenger Tonsillectome	25-9	Weil-Blakesley Sinuscopy Forcep	23-50 - 23-52
Snellen Ear Loop	22-35	West Septum Chisel	23-27
Soft Tissue Retractors	24-14	West Septum Gouge	23-27
Sphenoid Punches	23-17 - 23-19	Westmacott Nasal Polypus Forcep	23-8
Spoons-Ear	22-33	White Tonsil Seizing Forcep	25-7
Sprague Paracentesis Needle	22-37	Whitehead Mouth gag	24-6
Sprauge Paracentesis Knife	22-37	Wieder Tongue Depressor	24-9
St.Clair-Thompson Adenoid Curette	23-47	Wiener Nasal Rasp	23-34
Stammberger Sinuscopy Forcep	23-56	Wire Closure Forceps	22-6
Standard Sinuscopy Forcep	23-54	Wullstein Elevator	22-39
Standard Tongue Depressor	24-10	Wullstein Micro Ear Forcep	22-8
Stanzen Punch Sinuscopy Forcep	23-53	Wullstein Micro Ear Knife	22-9
Stemberg Cheek-Lip Retractor	24-8	Wullstein Micro Ear Scissor	22-5
Struempel Ear Polypus Forcep	22-30	Wullstein Suction Tube	22-17
Struycken Nasal Cutting Forcep	23-12	Y	
Struycken Septum Compression Forcep	23-14	Young Tongue Holding Forcep	24-13
Struycken Sinuscopy Forcep	23-52	Z	
Suction Tubes-Ear	22-17	Zaufal Foreign Body Instrument	22-34
T		Zollner Ear Hooklet	22-15
Tabb Micro Ear Knife	22-9	Zollner Ear Needle	22-15
Takahashi Nasal Cutting Forcep	23-11	Zollner Ear Speculum	22-19
Takahashi Sinuscopy Forcep	23-52	Zollner Suction Tube	22-17
Thudicum Nasal Speculum	23-2		
Tieck-Halle Nasal Speculum	23-3		
Tobold Tongue Depressor	24-9		
Tongue Depressors	24-8 - 24-11		
Tongue Holding Forcep	24-13		
Tonsil Forceps	25-5		
Tonsil Hemostats	25-10		
Tonsil Knives	25-3, 25-4		
Tonsil Needles	25-2		
Tonsil Packers	25-5		
Tonsil Punch Forceps	25-10		
Tonsil Retractors	25-5, 25-6		



Otology - Otologie - Otologia
 Micro Ear Forceps
 Mikro-Ohrzangchen
 Micro-Pinzas auriculares

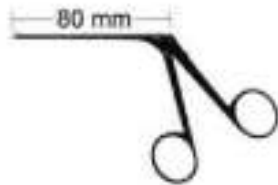

22-100-01 - 22-100-09

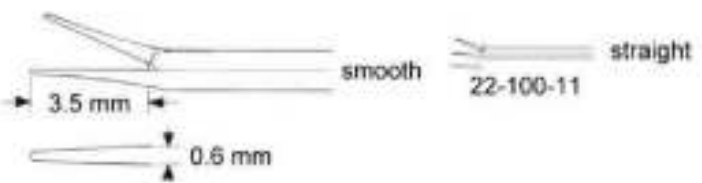
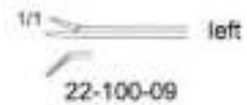
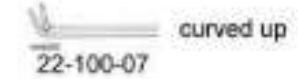
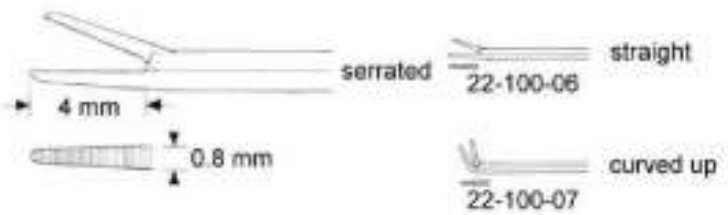
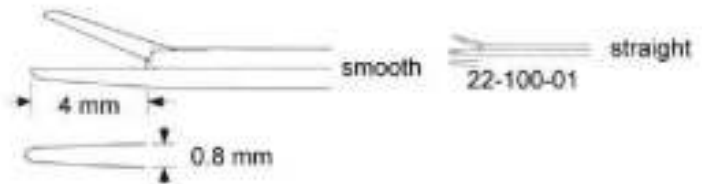

Mini McGee Alligator
 22-100-11 - 22-100-16

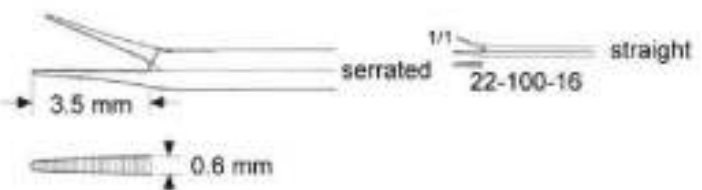



Otology - Otologie - Otologia
 Micro Ear Forceps
 Mikro-Ohrzangchen
 Micro-Pinzas auriculares

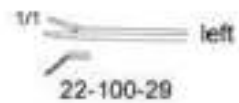
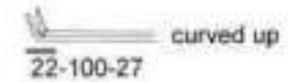
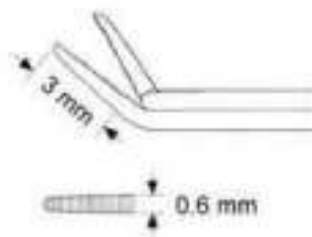
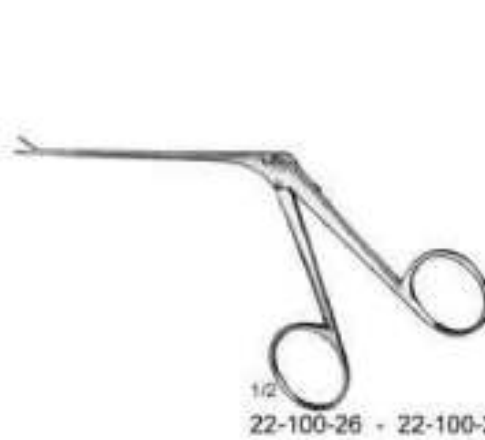
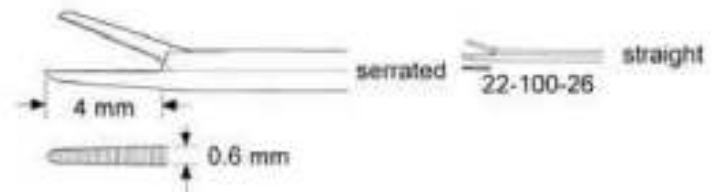
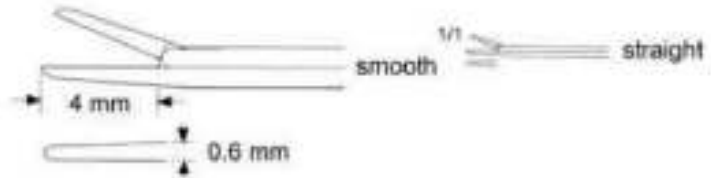
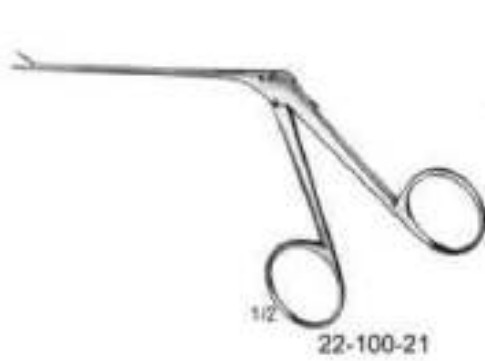
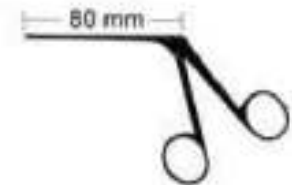



Otology - Otologie - Otologia
Micro Ear Forceps
Mikro-Ohrzangchen
Micro-Pinzas auriculares

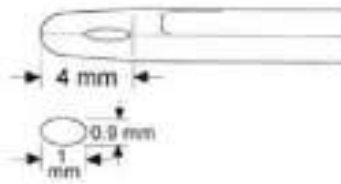
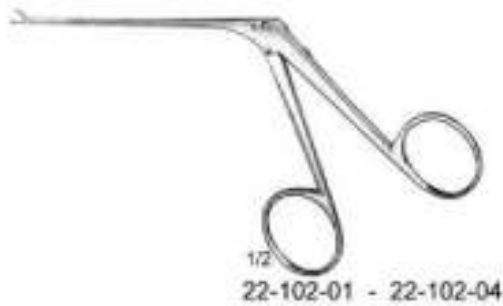

straight
22-102-01

curved up
22-102-02

right
22-102-03

left
22-102-04

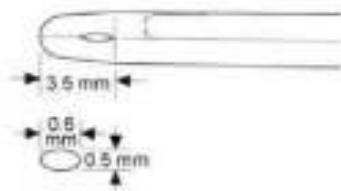

straight
22-102-11

curved up
22-102-12

right
22-102-13





left
22-102-14



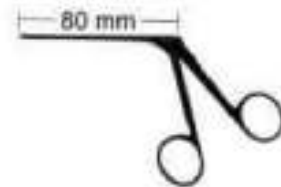
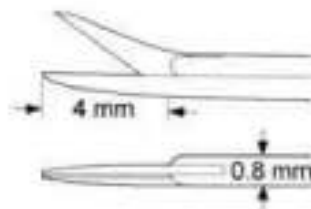
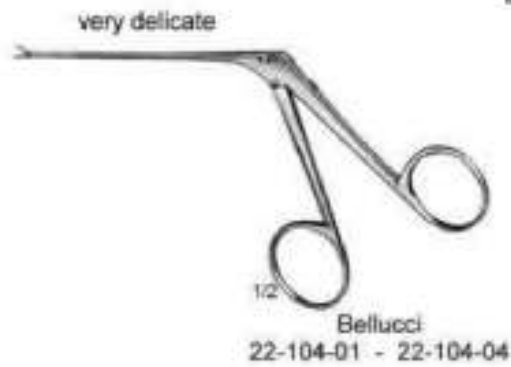





Otology - Otologie - Otologia
 Micro Ear Scissors
 Mikro-Ohrzangchen
 Micro-ciseaux auriculaires

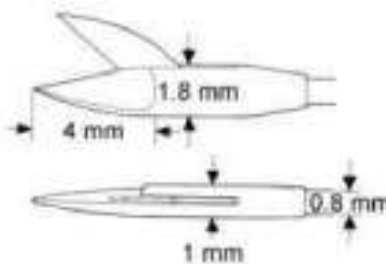
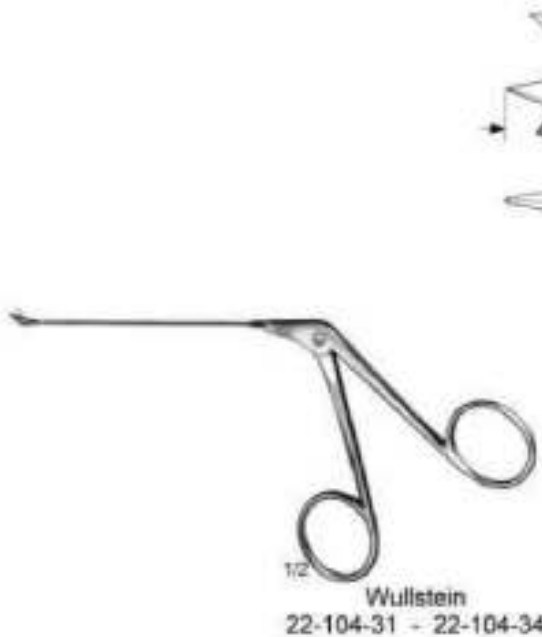

-  straight
22-104-01
-  curved up
22-104-02
-  right
22-104-03
-  left
22-104-04



-  straight
22-104-31
-  curved up
22-104-32
-  right
22-104-33
-  left
22-104-34



Otology - Otologie - Otologia
 Wire Closure Forceps
 Drahtbiegezugchen
 Pinzas para doblar alambre

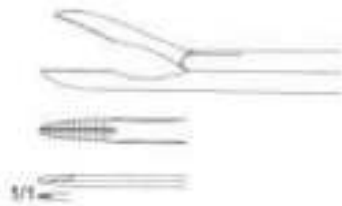
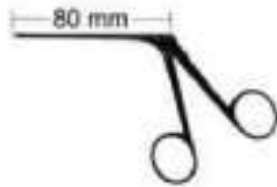

Greven
22-110-01



Schuknecht
22-110-08



22-110-11 0.8 x 3.5 mm

22-110-12 0.8 x 6.0 mm



McGee
22-110-11 - 22-110-12



22-110-16 left
22-110-17 right



Juers
22-110-16 - 22-110-17



Otology - Otologie - Otologia
Crura and Malleus Nippers
Crurotomie-und Hammerkopfzangchen
Pinzas para la cruroromia y la cadeza del martillo

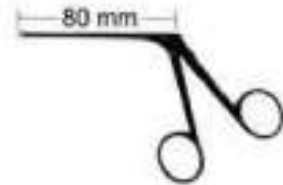

Scale
22-112-01 up
1/10 mm
22-112-02 down



House - Dieter
22-112-01 - 22-112-02

Scale
22-112-06 right
1/10 mm
22-112-07 left



House - Dieter
22-112-06 - 22-112-07



Fuller
22-114-01



Otology - Otologie - Otologia
Micro Ear Forceps
Mikro-Ohrzangchen
Micor-Pinzas auriculares



22-120-01



22-120-02



22-120-03



Wullstein

22-120-01 - 22-120-03

Otology - Otologie - Otologia
Knives
Messer
Cuchillos

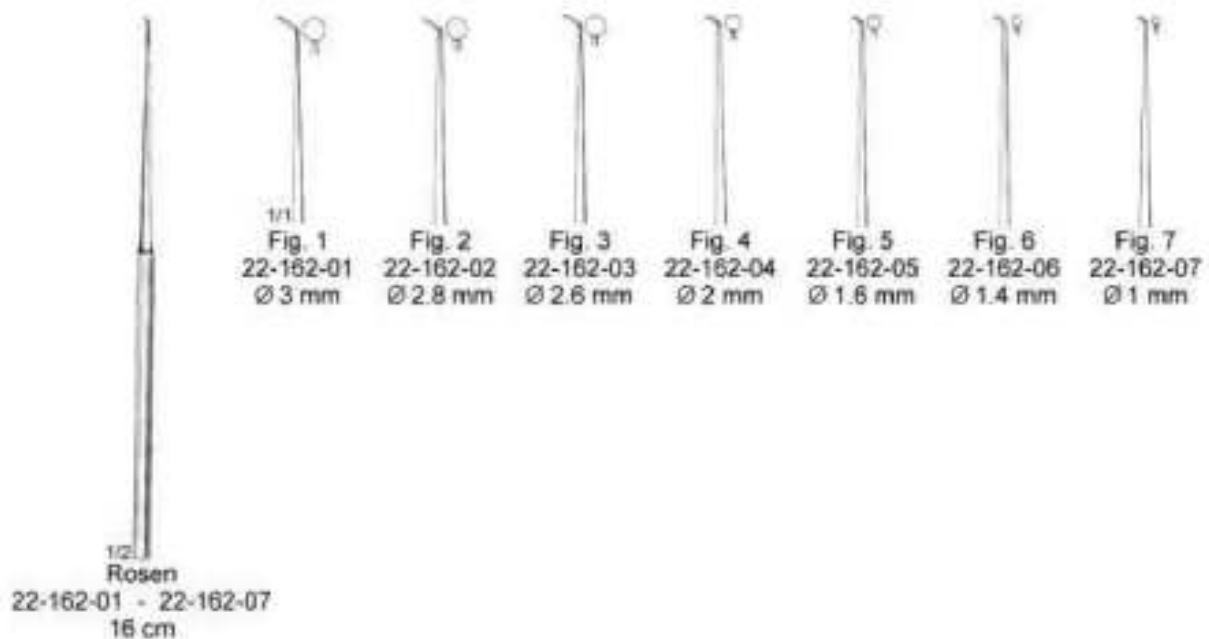
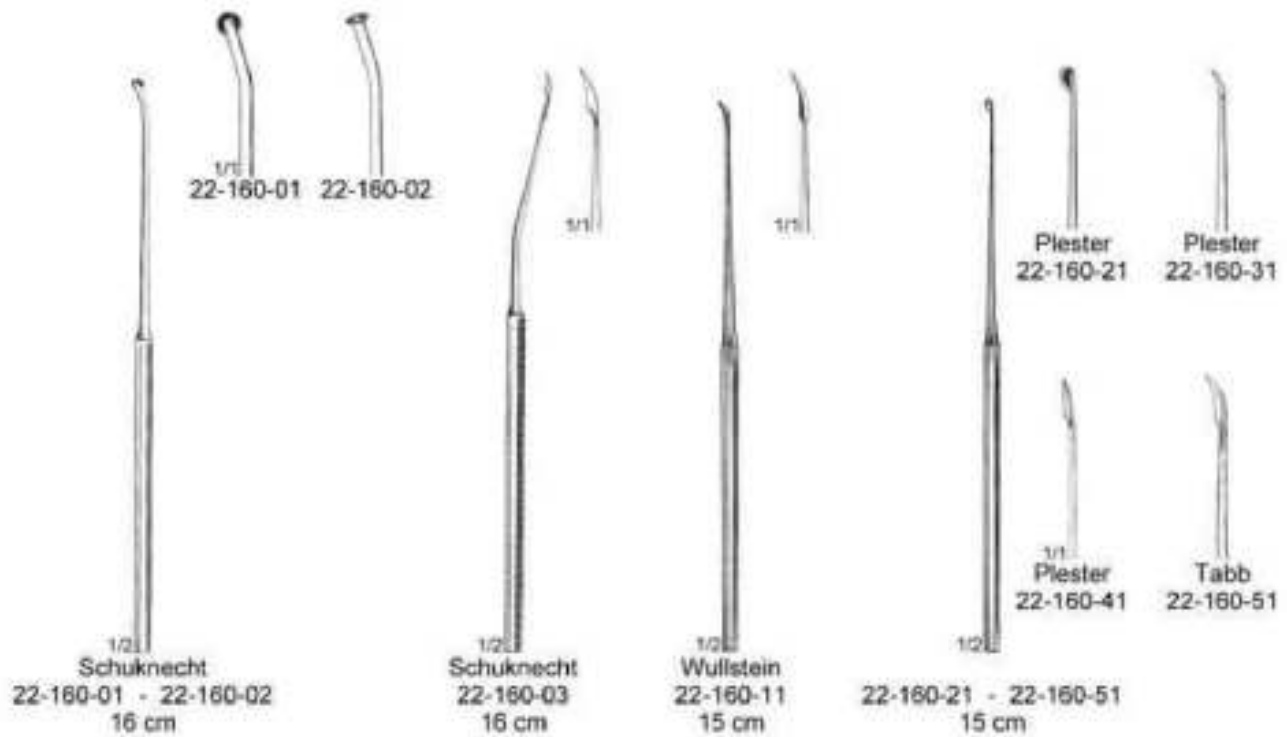



Otology - Otologie - Otologia
Needles, Picks and Hooks, straight shaft
Nadeln und Hakchen, mit geradem Schaft
Agujas y Ganchos con vastago recto

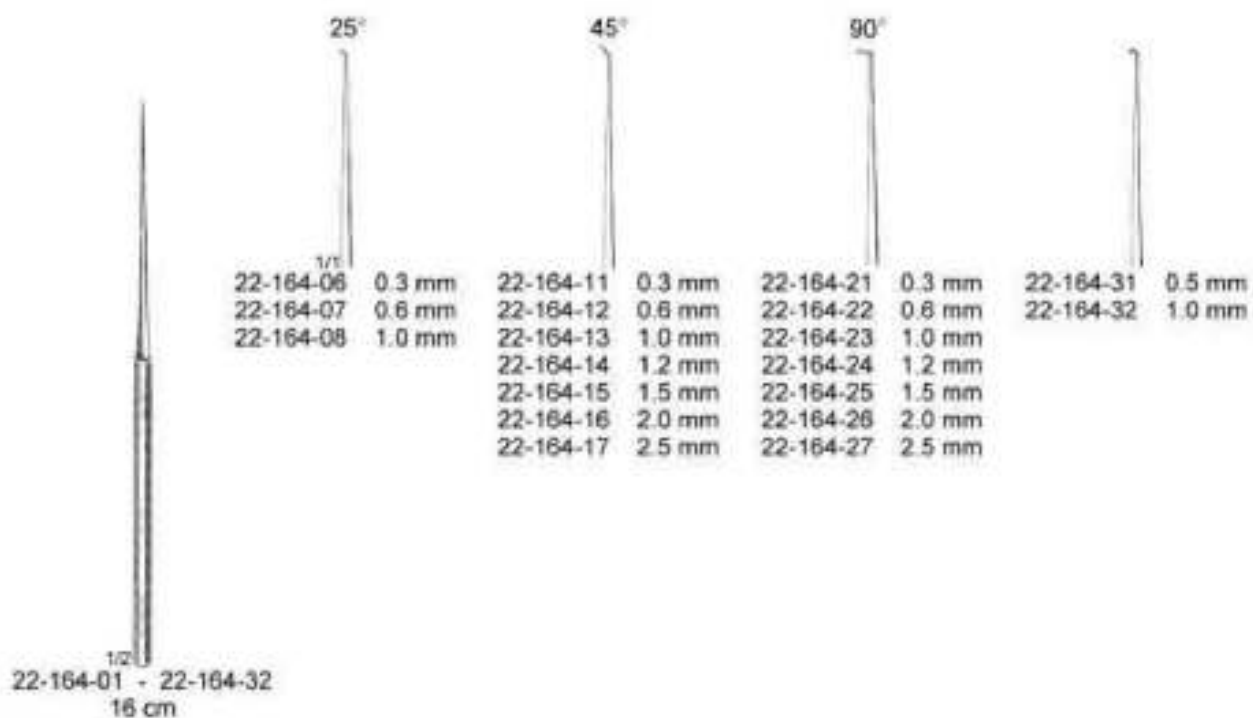
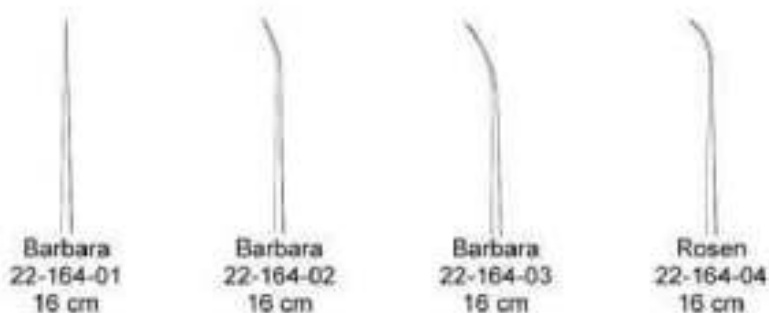



Otology - Otologie - Otologia
Needles, Picks and Hooks with angled shaft
Nadeln und Hakchen, mit abgewinkeltem Schaft
Agujas y Ganchitos con vastago acodado

25°

1/1	22-170-03	0.3 mm
	22-170-06	0.6 mm
	22-170-10	1.0 mm

45°

	22-172-03	0.3 mm
	22-172-06	0.6 mm
	22-172-10	1.0 mm

90°

	22-174-03	0.3 mm
	22-174-06	0.6 mm
	22-174-10	1.0 mm

1/1

	22-171-03	0.3 mm
	22-171-06	0.6 mm
	22-171-10	1.0 mm

	22-173-03	0.3 mm
	22-173-06	0.6 mm
	22-173-10	1.0 mm

	22-175-03	0.3 mm
	22-175-06	0.6 mm
	22-175-10	1.0 mm



1/1

	McGee	
	22-176-05	0.5 mm
	22-176-10	1.0 mm

	McGee	
	22-177-05	0.5 mm
	22-177-10	1.0 mm





Otology - Otologie - Otologia
Dissectors, Elevators, Curettes, Mobilizer etc.
Dissektoren, Raspatorien, Kuretten, Haken usw.
Disecador, Raspatoria, Cucharillas, Ganchitos etc.

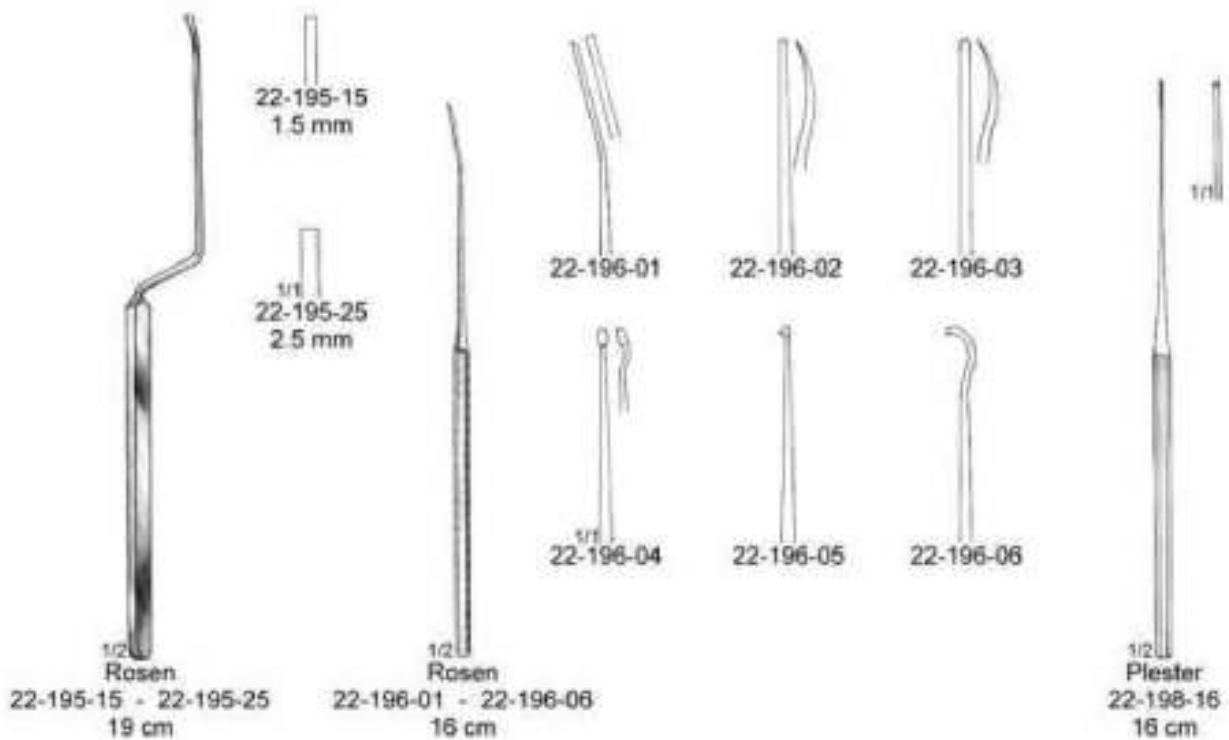
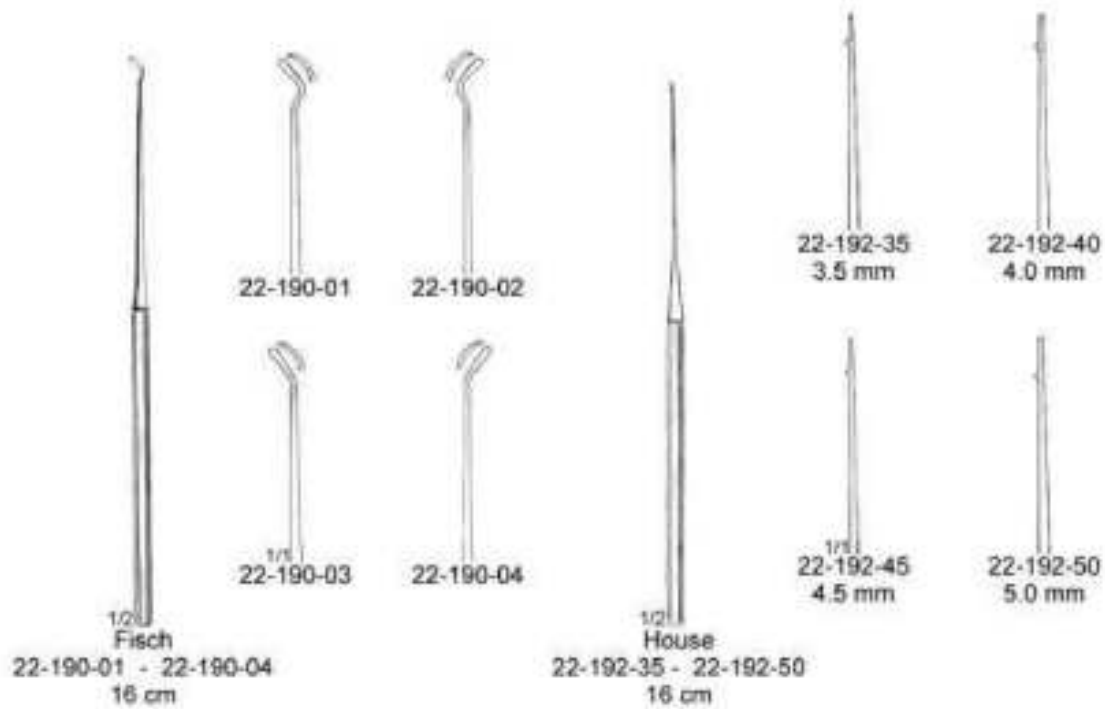

Otology - Otologie - Otologia
Footplate Hand Instruments
Instrumente für die Stapes-Fußplatte
Instrumentos para la platina estapediense

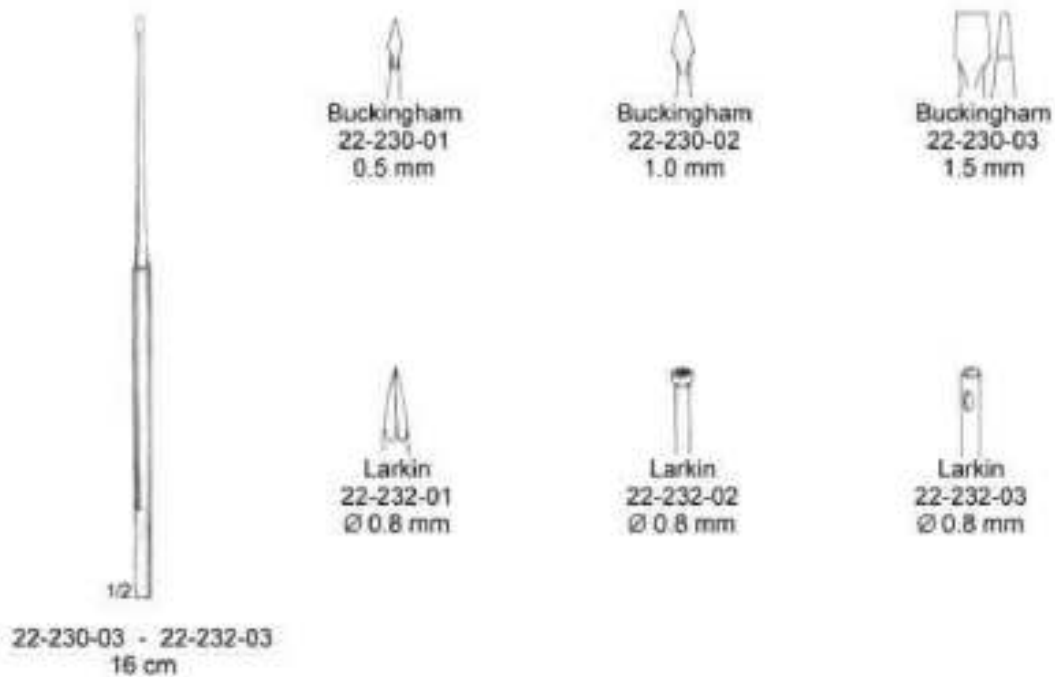
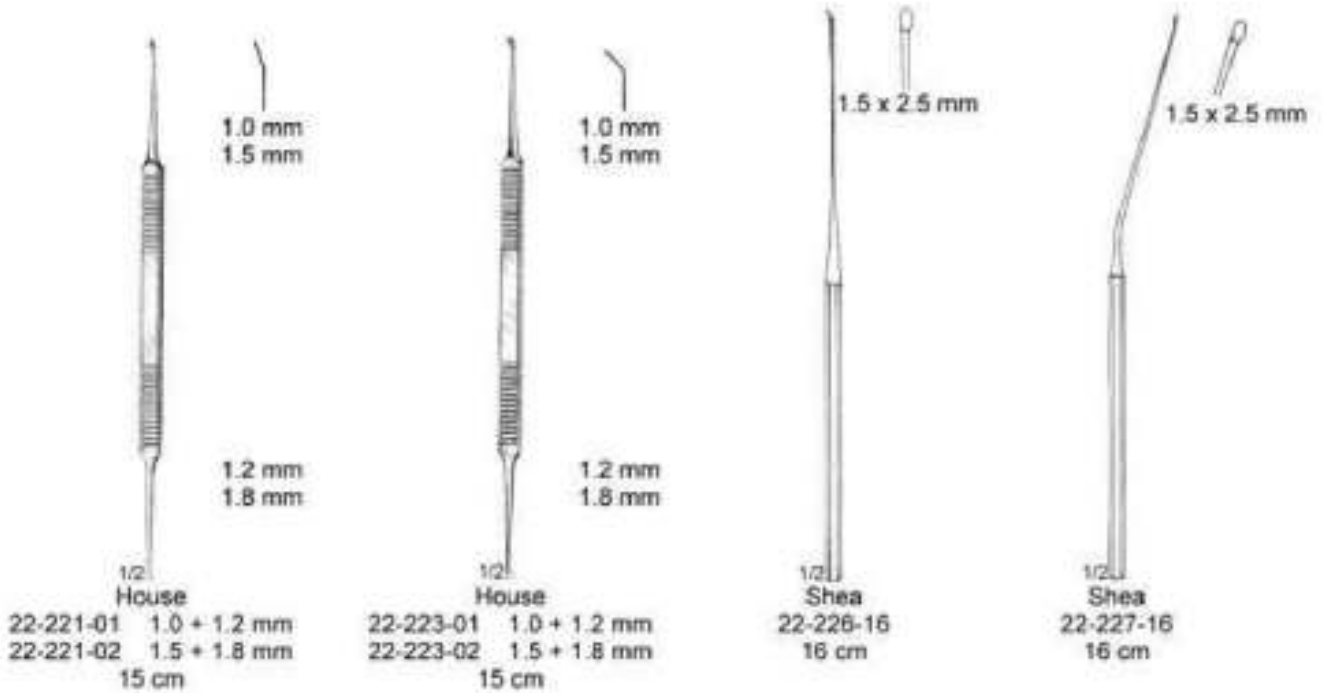

Otology - Otologie - Otologia
Footplate Instruments acc. To Heermann
Stapesplatten Instrumente n. Heermann
Instrumental estapediense de Heermann





Otology - Otologie - Otologia
Needles, Hooklets
Nadeln, Hakchen
Agujas, Ganchos



1/1
Zollner
22-256-01 - 22-256-17
13.5 cm

22-256-01













- ↓ 22-256-02 45°/0.5 mm
- ↓ 22-256-03 45°/1.0 mm
- ↑ 22-256-04 45°/0.5 mm
- ↑ 22-256-05 45°/1.0 mm
- ↑ 22-256-06 90°/0.5 mm
- ↓ 22-256-07 90°/0.5 mm
- ↑ 22-256-08 1.0 mm
- ↓ 22-256-09 1.0 mm

- ↑ 22-256-10 90°
- ↓ 22-256-11 90°
- ↑ 22-256-12
- ↓ 22-256-13
- 22-256-14
- ← 22-256-15
- 22-256-16
- ← 22-256-17

Otology - Otologie - Otologia
Needles
Nadeln
Agujas



1/16
Schuknecht
22-260-01 - 22-264-40
16.5 cm

			22-260-01				
			22-260-02				
							
45°		0.2 mm	22-262-02	22-262-12	22-262-22	22-262-32	
		0.4 mm	22-262-04	22-262-14	22-262-24	22-262-34	
		0.6 mm	22-262-06	22-262-16	22-262-26	22-262-36	
		0.8 mm	22-262-08	22-262-18	22-262-28	22-262-38	
		1.0 mm	22-262-10	22-262-20	22-262-30	22-262-40	
							
90°		0.2 mm	22-264-02	22-264-12	22-264-22	22-264-32	
		0.4 mm	22-264-04	22-264-14	22-264-24	22-264-34	
		0.6 mm	22-264-06	22-264-16	22-264-26	22-264-36	
		0.8 mm	22-264-08	22-264-18	22-264-28	22-264-38	
		1.0 mm	22-264-10	22-264-20	22-264-30	22-264-40	

Otology - Otologie - Otologia
Suction Tubes
Saugrohre
Tubos de aspiracion



House

22-300-09	0.9 + 0.7 mm
22-300-12	1.2 + 0.9 mm
22-300-15	1.5 + 1.2 mm
22-300-18	1.8 + 1.8 mm
22-300-25	2.5 + 2.0 mm
22-300-30	3.0 + 2.0 mm
22-300-45	4.5 + 2.0 mm



Baron (Schuknecht)

22-302-10	1.0 x 75 mm
22-302-15	1.5 x 75 mm
22-302-20	2.0 x 75 mm



Zollner
22-305-00



22-305-05	∅ 0.5 mm
22-305-07	∅ 0.7 mm



Wullstein
22-306-00



Wullstein
22-307-00



House



22-308-06	0.6 mm
22-308-08	0.8 mm
22-308-10	1.0 mm
22-308-12	1.2 mm
22-308-15	1.5 mm
22-308-18	1.8 mm
22-308-20	2.0 mm
22-308-22	2.2 mm
22-308-25	2.5 mm
22-308-30	3.0 mm

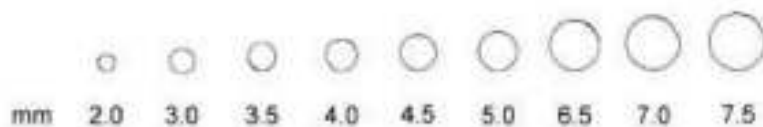

Otology - Otologie - Otologia
 Ear Specula
 Ohrspekula
 Especulos auriculares

∅ = inside diameter

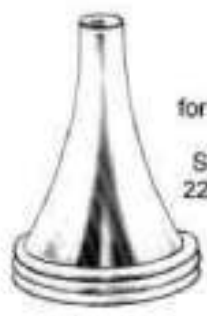

		Set 1 - 3 22-400-03		for children Set 0 - 2 22-404-03		for adults Set 2 - 4 22-408-03 Set 1 - 4 22-408-04
mm	Politzer		Hartmann		Hartmann	
2.0	22-401-01		22-405-00			
3.0	22-401-02					
3.5			22-405-01		22-409-01	
4.0	22-401-03					
5.0	22-401-04		22-405-02		22-409-02	
6.5					22-409-03	
7.5					22-409-04	

		black Set 0 - 3 22-410-03		Set 2 - 4 22-414-03 Set 1 - 4 22-414-04		
mm	Hartmann		Toynbee		Gruber	
3.0	22-411-00		22-415-01			
4.0	22-411-01		22-415-02			
4.5					22-419-01	
5.0	22-411-02		22-415-03			
5.5					22-419-02	
6.5			22-415-04		22-419-03	
7.0	22-411-03				22-419-04	

Otology - Otologie - Otologia
Ear Specula
Ohrspekula
Especulos auriculares

Aluminium black



Zollner
22-420-00

Set 1 - 6

- 22-421-01
5.5 x 6.5 mm
- 22-421-02
6.5 x 7.5 mm
- 22-421-03
7.5 x 8.5 mm
- 22-421-04
8.5 x 9.5 mm
- 22-421-05
9.5 x 10.5 mm
- 22-421-06
10.5 x 11.5 mm



Boucheron
22-424-00

Set 1 - 4

- 22-425-01
3.5 mm
- 22-425-02
4.5 mm
- 22-425-03
5.5 mm
- 22-425-04
6.5 mm

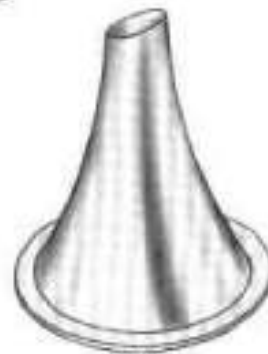

Farrior
22-430-33 - 22-435-75



- | | | | | | |
|--------|-----------|--------------|-----------|-----------|-----------|
| 3.3 mm | 22-430-33 | 3.0 x 4.0 mm | 22-432-30 | 22-433-30 | 22-435-30 |
| 4.3 mm | 22-430-43 | 4.0 x 5.0 mm | 22-432-40 | 22-433-40 | 22-435-40 |
| 4.8 mm | 22-430-48 | 4.5 x 5.5 mm | 22-432-45 | 22-433-45 | 22-435-45 |
| 5.3 mm | 22-430-53 | 5.0 x 6.0 mm | 22-432-50 | 22-433-50 | 22-435-50 |
| 5.8 mm | 22-430-58 | 5.5 x 6.5 mm | 22-432-55 | 22-433-55 | 22-435-55 |
| 6.3 mm | 22-430-63 | 6.0 x 7.0 mm | 22-432-60 | 22-433-60 | 22-435-60 |
| 6.7 mm | 22-430-67 | 6.5 x 7.5 mm | 22-432-65 | 22-433-65 | 22-435-65 |
| 7.2 mm | 22-430-72 | 7.0 x 8.0 mm | 22-432-70 | 22-433-70 | 22-435-70 |
| 7.7 mm | 22-430-77 | 7.5 x 8.5 mm | 22-432-75 | 22-433-75 | 22-435-75 |



Otology - Otologie - Otologia
Ear Specula
Ohrspekula
Especulos auriculares

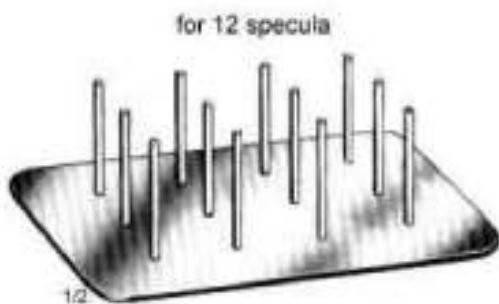

22-450-12



Richnau Holmgren
22-456-02 Ø 2 mm
22-456-04 Ø 4 mm
22-456-06 Ø 6 mm

Otology - Otologie - Otologia
Tuning Forks
Stimmgabeln
Diapasones

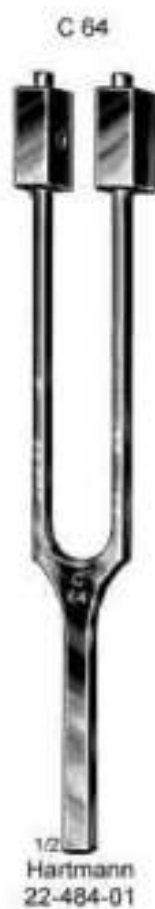



Otology - Otologie - Otologia
Tuning Forks
Stimmgabeln
Diapasones

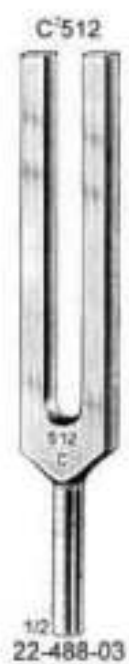
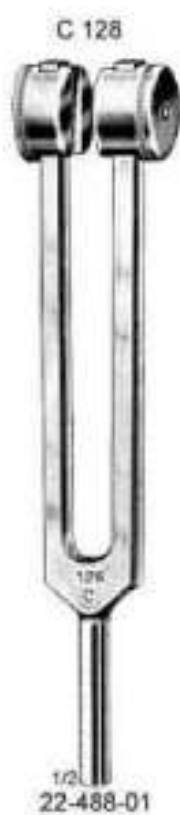



Otology - Otologie - Otologia
Tuning Forks
Stimmgabeln
Diapasones

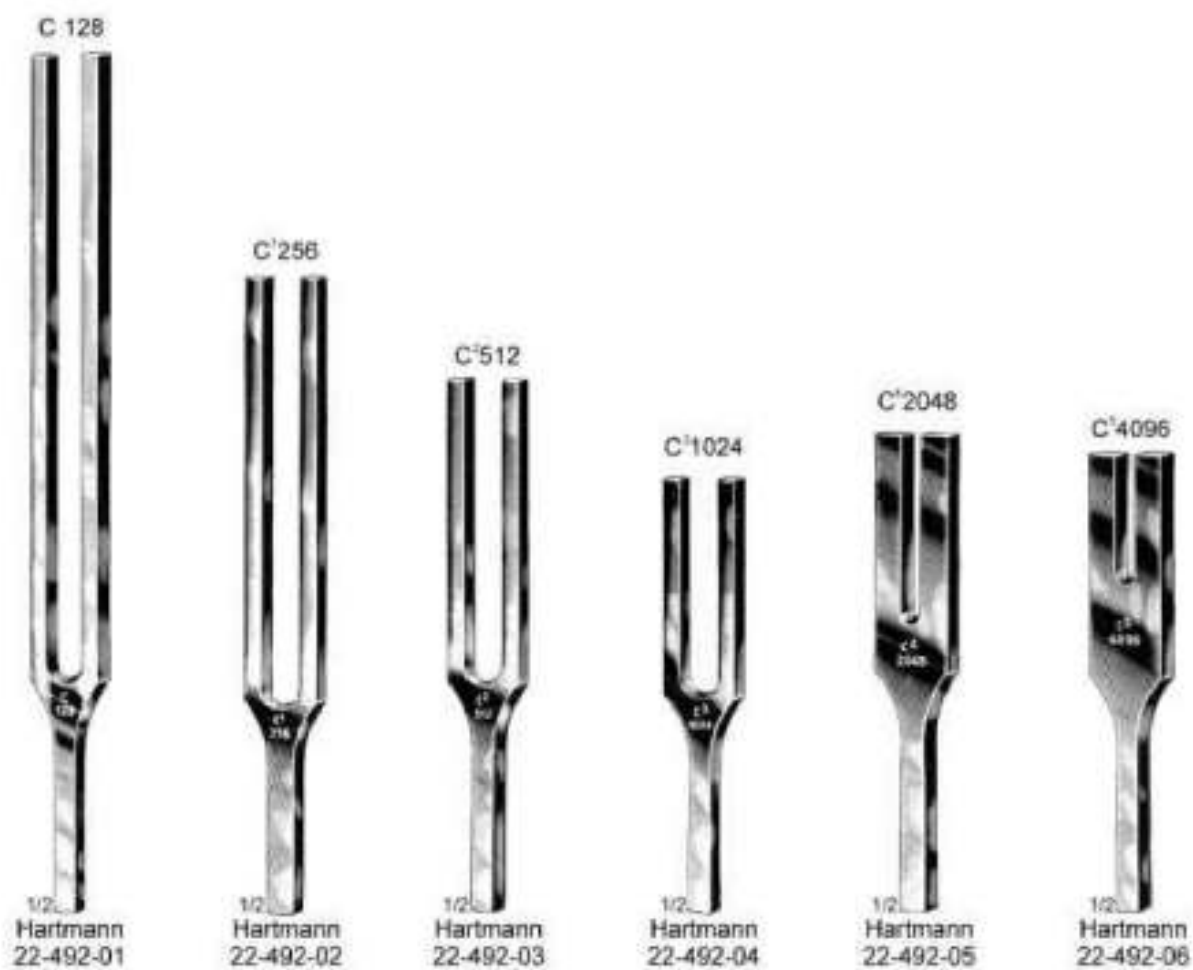



Otology - Otologie - Otologia
Tuning Forks
Stimmgabeln
Diapasones

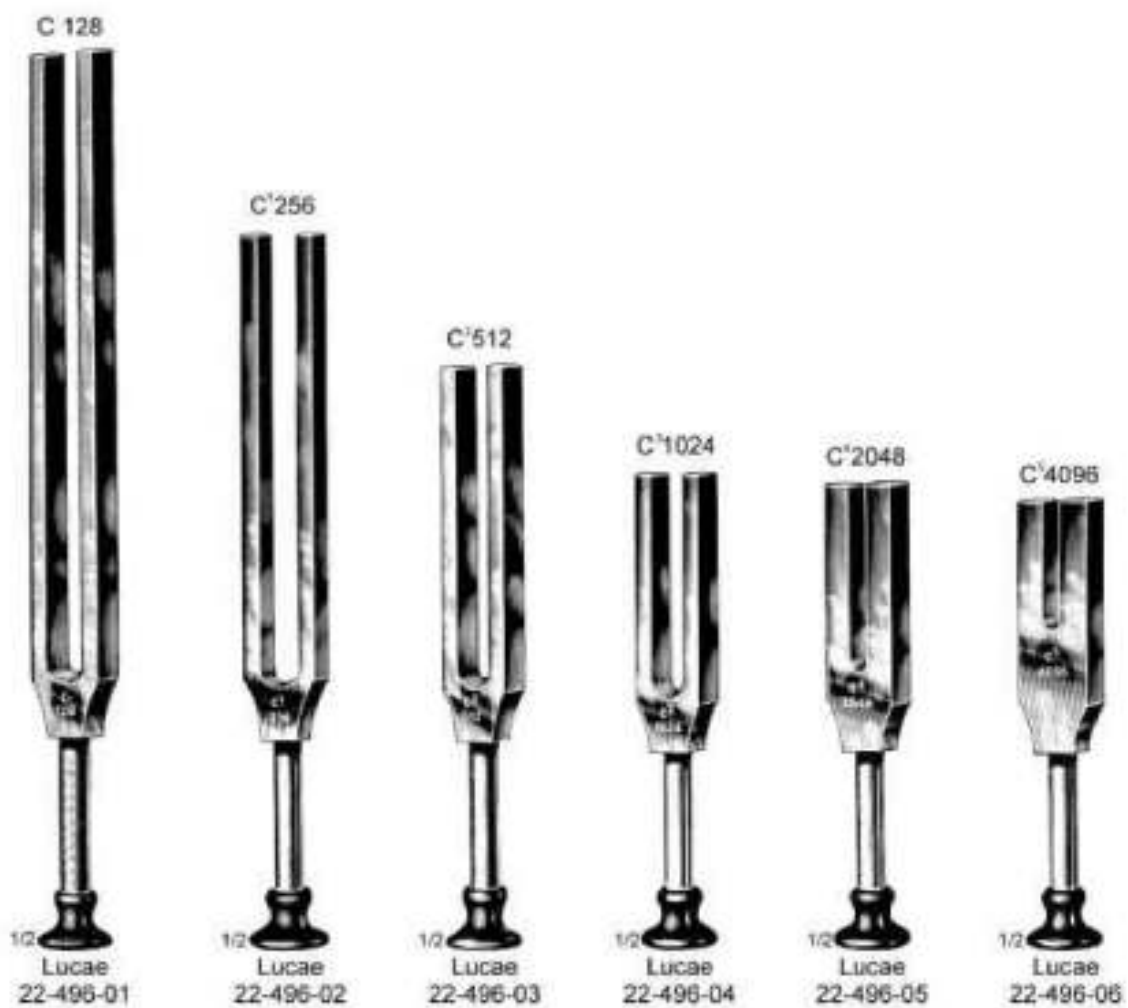



Otology - Otologie - Otologia
Tuning Forks
Stimmgabeln
Diapasones

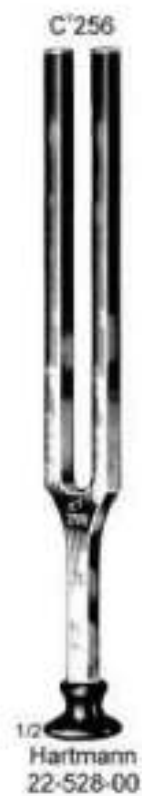
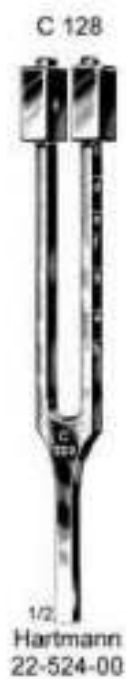



Otology - Otologie - Otologia
Tuning Forks
Stimmgabeln
Diapasones



1/2
Rydel - Seiffer
22-530-00



1/2
22-534-00



1/2
Koenig
22-538-00



1/2
22-542-00



Otology - Otologie - Otologia
Eustachian Catheters, Ear Polypus Snares
Ohrkatheter, Polypenschnurer
Sondas auriculares, Polipotomos

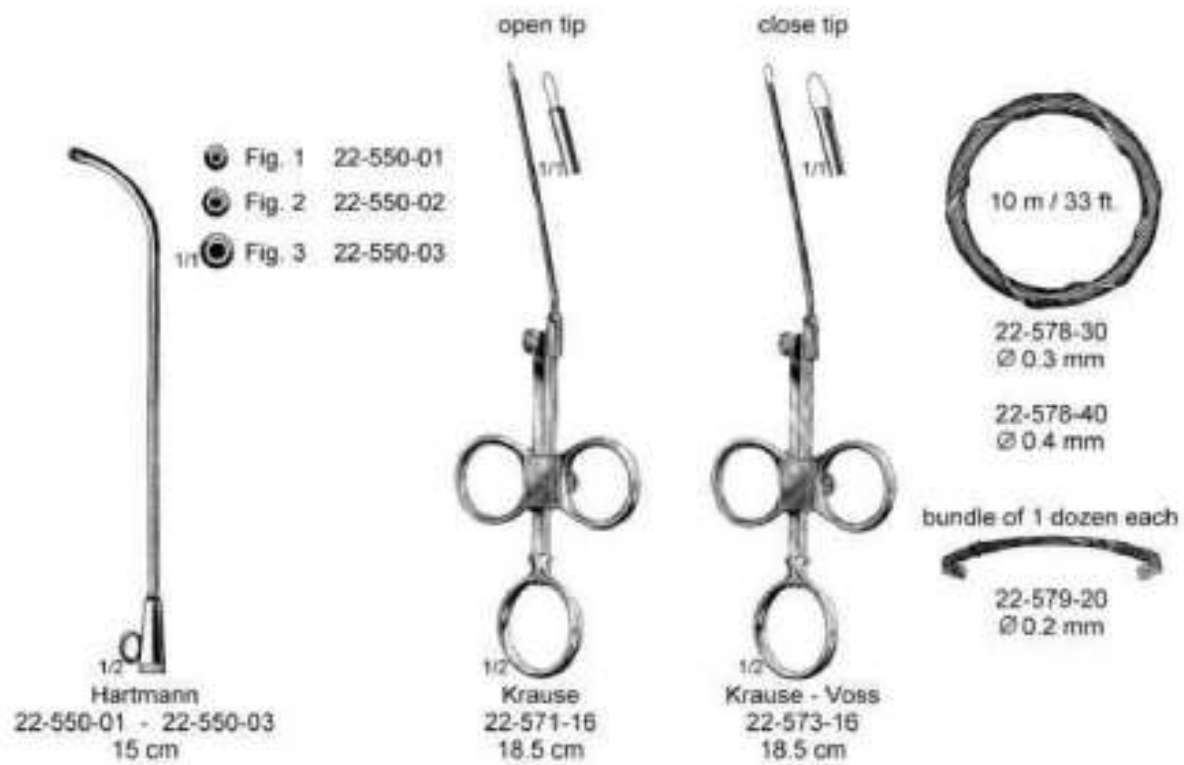



Otology - Otologie - Otologia
 Ear Dressing Forceps
 Ohrpinzetten
 Pinzas auriculares

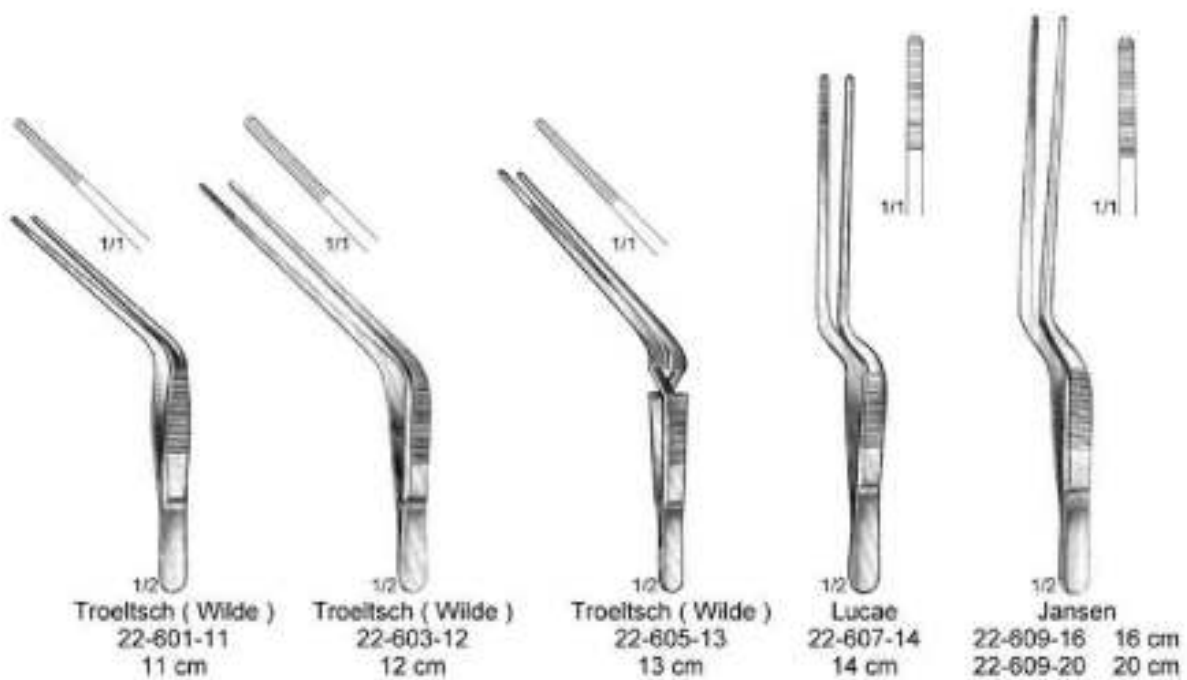

Otology - Otologie - Otologia
Ear Polypus Forceps, Foreign Body Levers
Polypenzangchen, Fremdkörperheber
Pinzas para polipos, Elevadores para cuerpos extraños

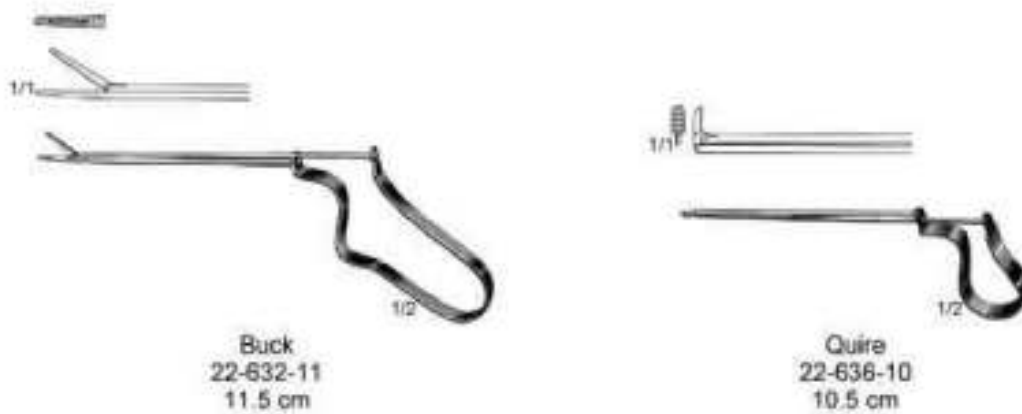
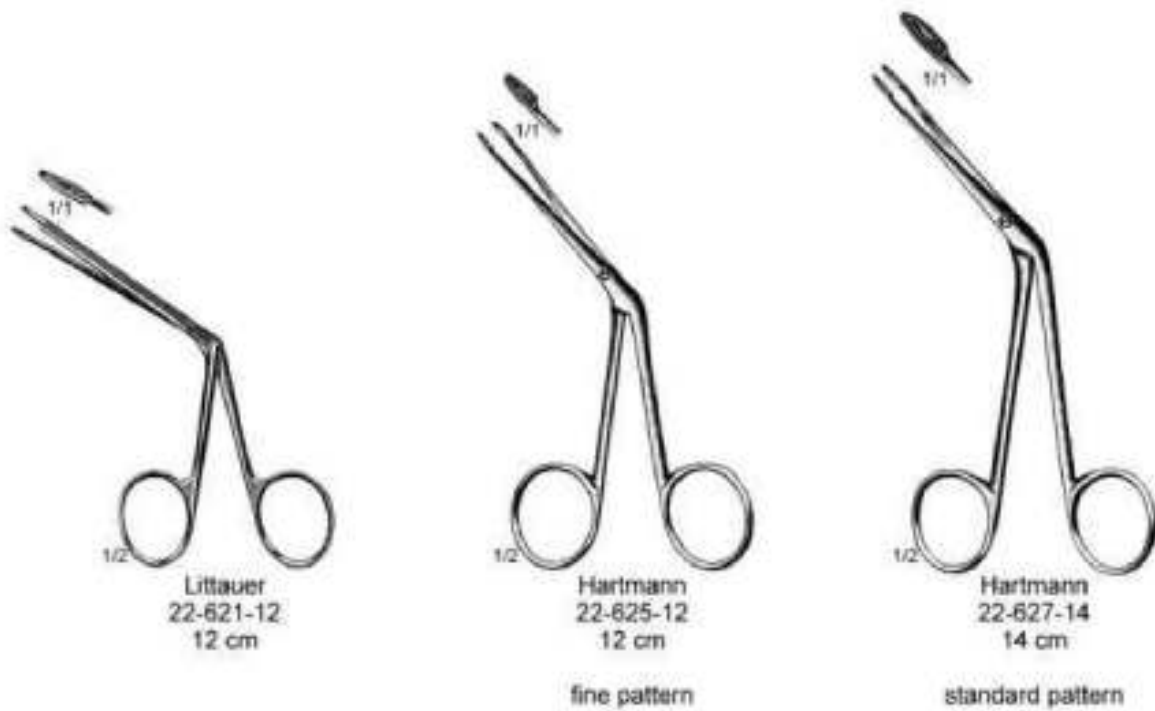



Otology - Otologie - Otologia
Ear Polypus Forceps
Ohr-Polypenzangen
Pinzas para polipos auriculares



- 2.0 mm
- 2.5 mm
- 3.0 mm





- 2.0 mm
- 2.5 mm
- 3.0 mm



22-650-08 - 22-672-08

Otology - Otologie - Otologia
Punches
Knochenstanzen
Pinzas-osteotomos

 22-690-17 1 mm
 22-692-17 2 mm
 22-694-17 3 mm



Citelli
22-690-17 - 22-694-17

 2 mm



Beyer
22-698-19

 1 mm



Beyer
22-702-14



Otology - Otologie - Otologia
Curettes
Kuretten
Curetas



1/2
Langenbeck
22-731-13
13 cm



1/2
Shapleigh
22-733-01 - 22-733-04
13 cm



1/2
Buck
22-736-01 - 22-737-14
16.5 cm

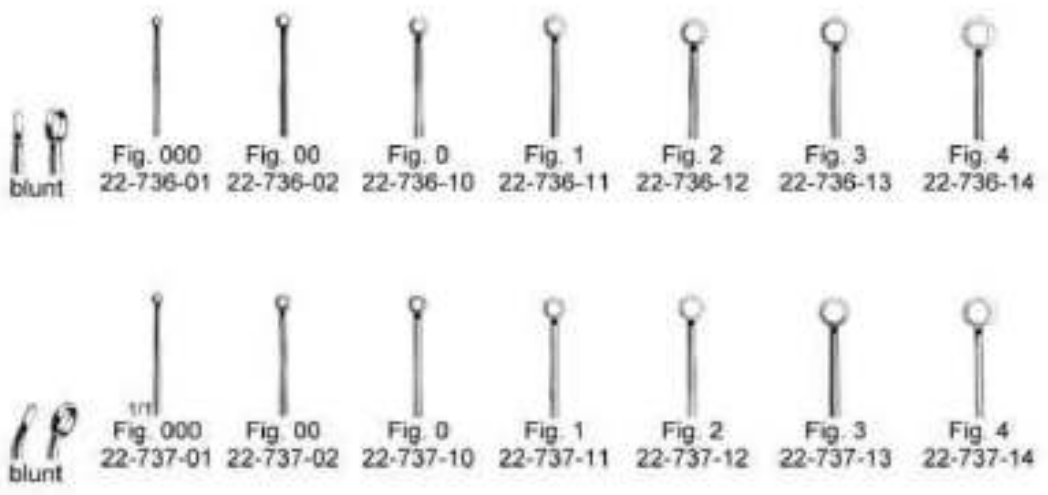

Otology - Otologie - Otologia
Curettes and Spoons
Kuretten, Löffel
Curetas y Cucharillas

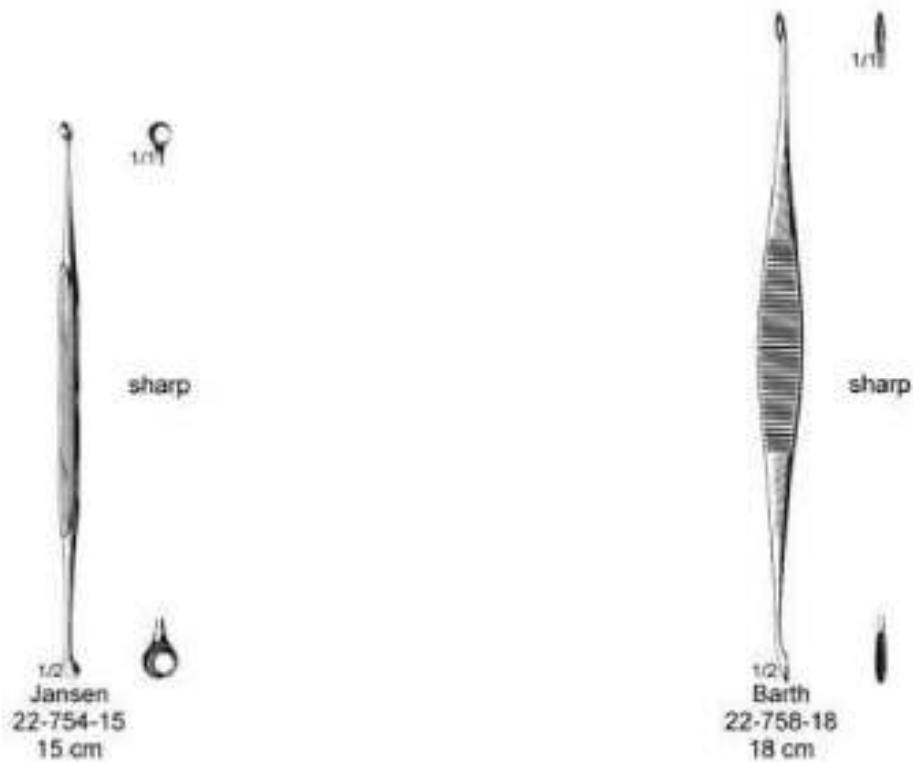
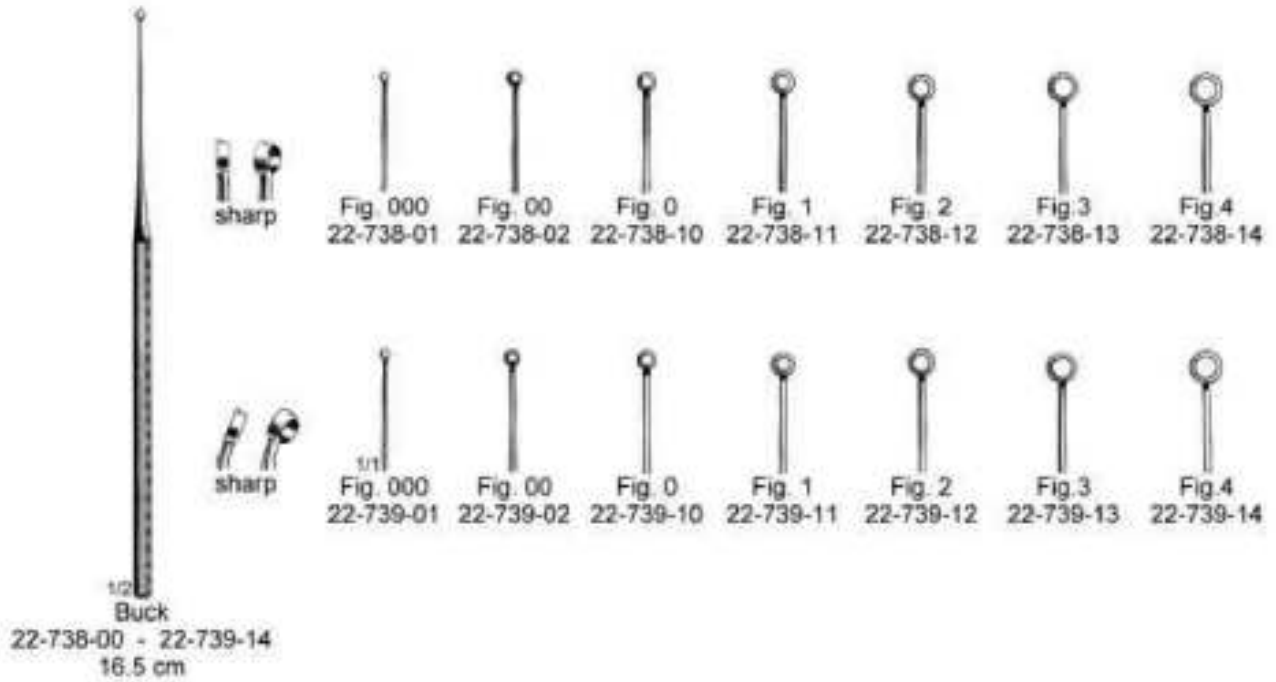

Otology - Otologie - Otologia
Loops, Foreign Body Instruments, Hooks
Schlingen, Fremdkörperinstrumente, Haken
Asas, Instrumentos para cuerpos extraños, Ganchos

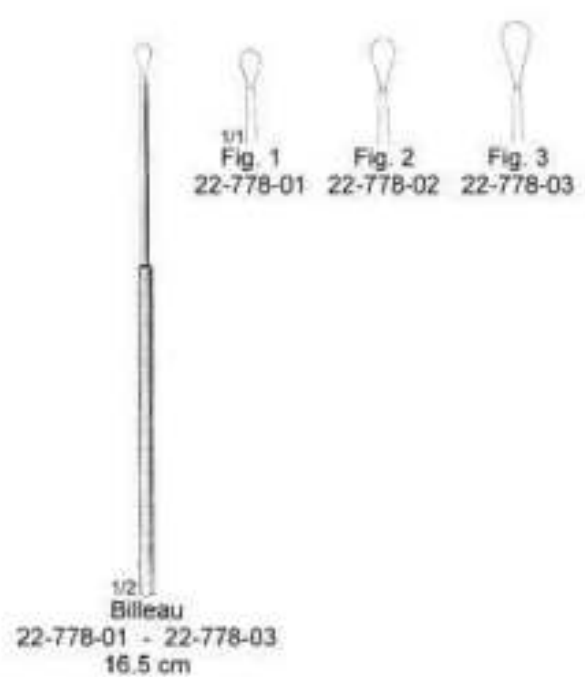
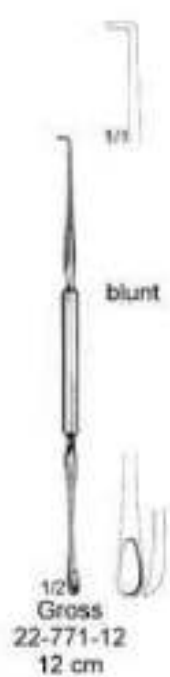



Otology - Otologie - Otologia
Loops, Hooklets
Schlingen, Hakchen
Asas, Ganchitos

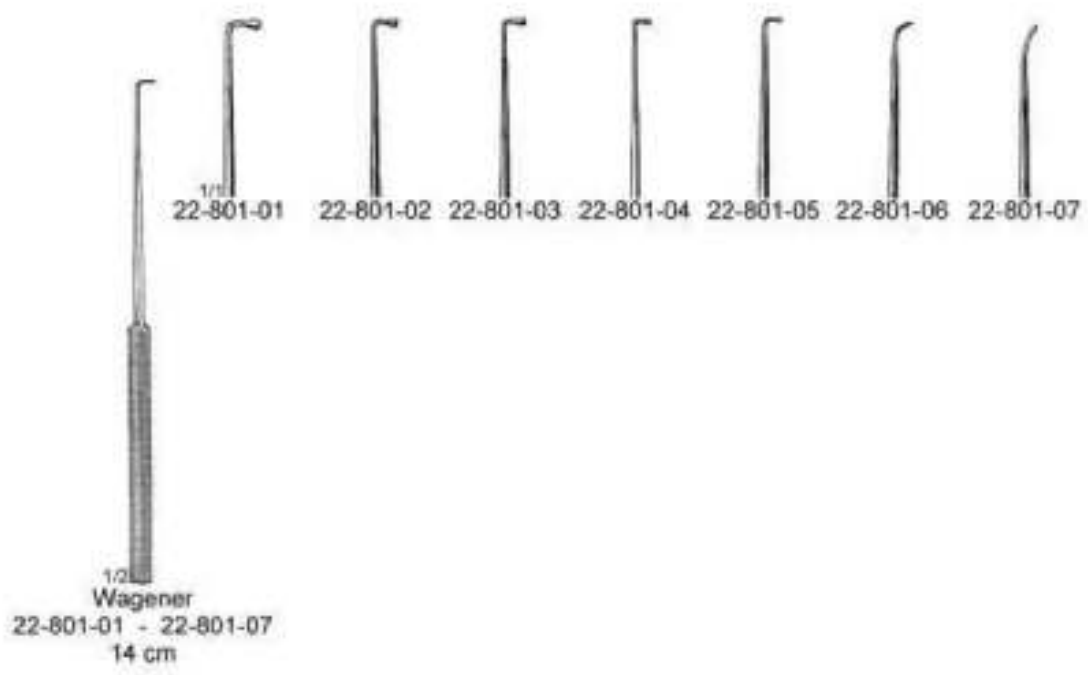
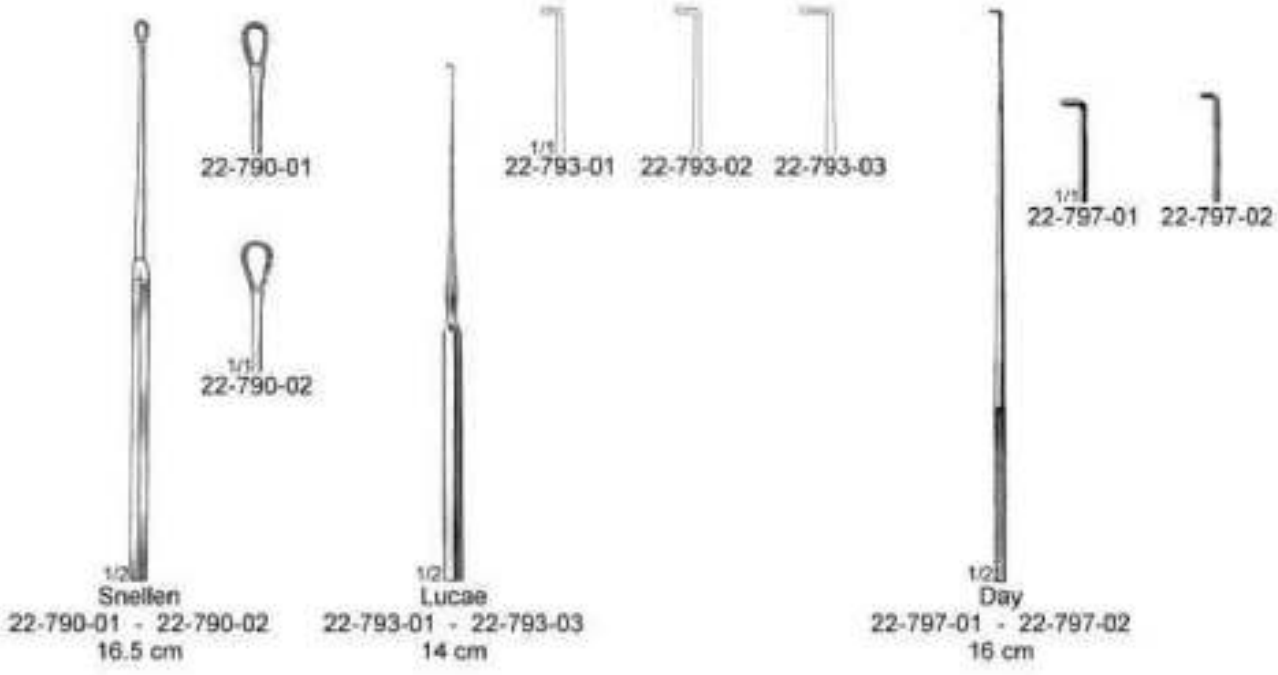

Otology - Otologie - Otologia
 Paracentesis Needles
 Parazentesenadeln
 Agujas para paracentesis

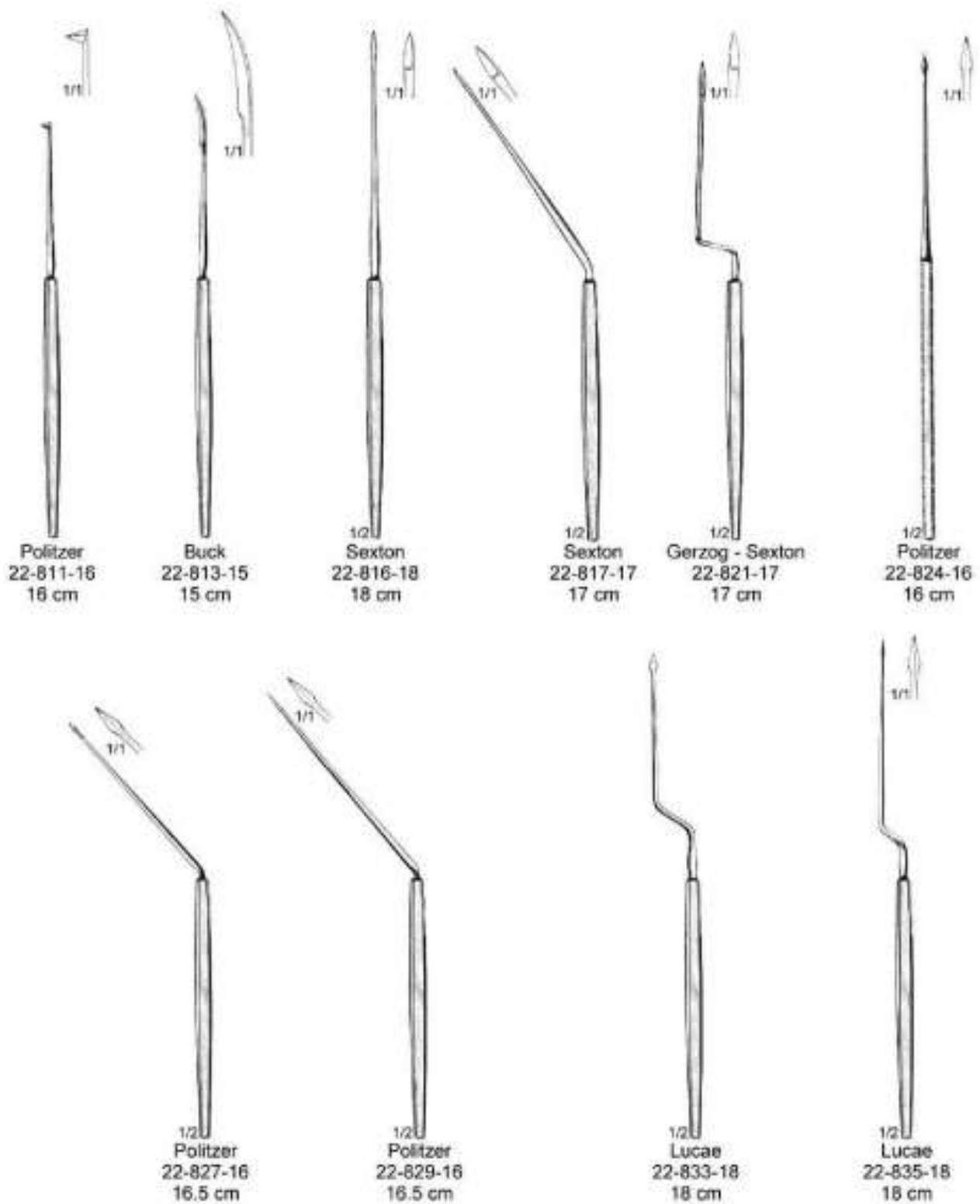



Otology - Otologie - Otologia
Paracentesis Needles, Knives
Parazentesenadeln, Messer
Agujas para paracentesis, Cuchillos



Ear Operating Set





Otology - Otologie - Otologia
Elevators, Raspatories, Curettes etc.
Elevatoren, Raspatorien, Löffel usw.
Elevadores, Periotomos, Curetas

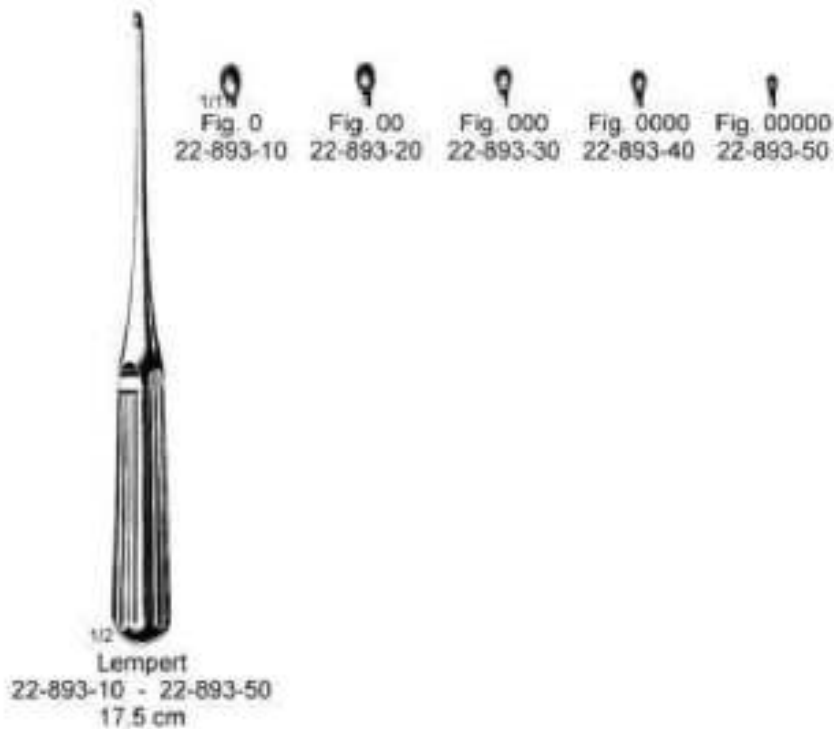
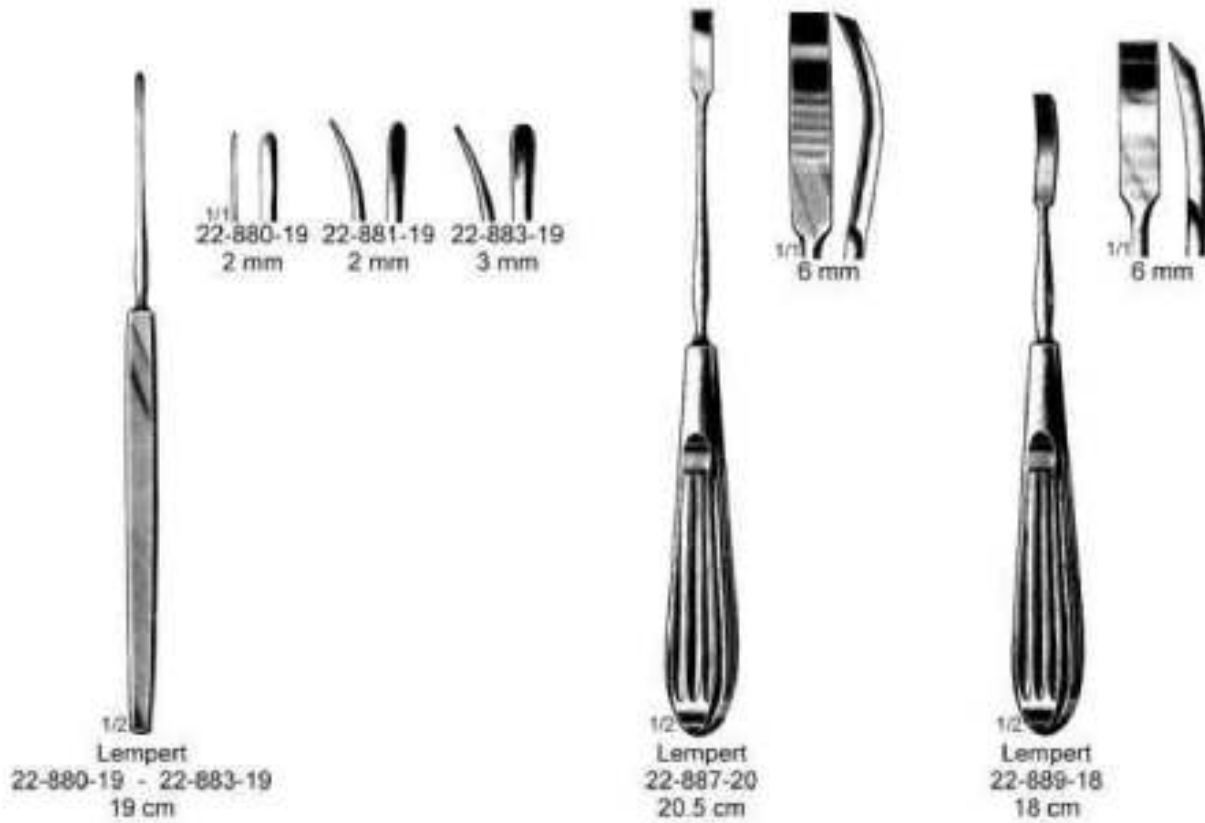

Otology - Otologie - Otologia
Elevators
Elevatorien
Elevadores

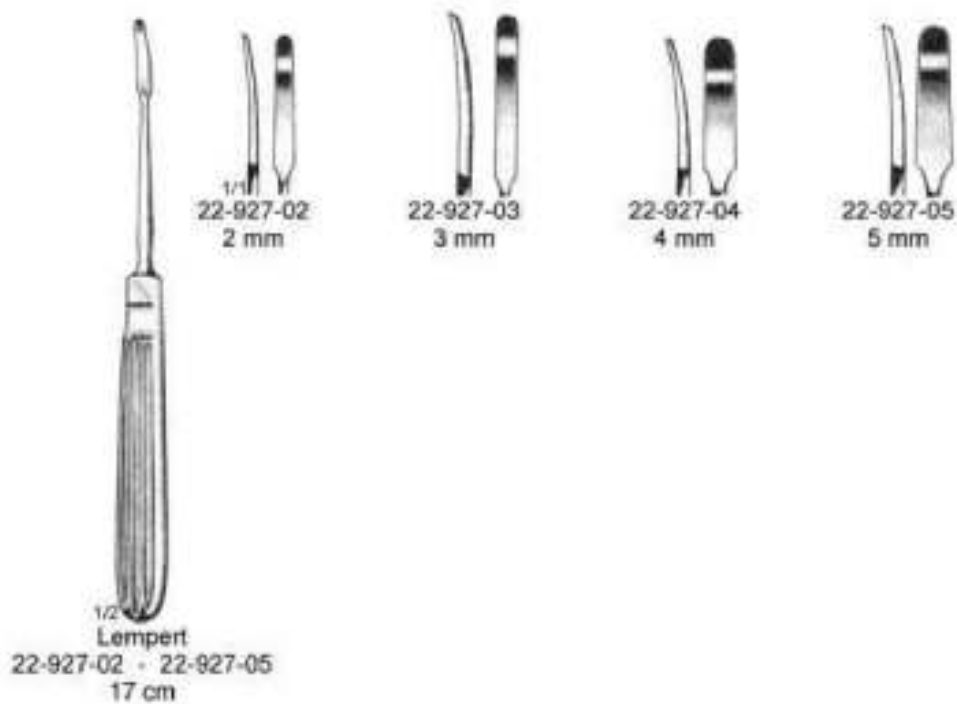
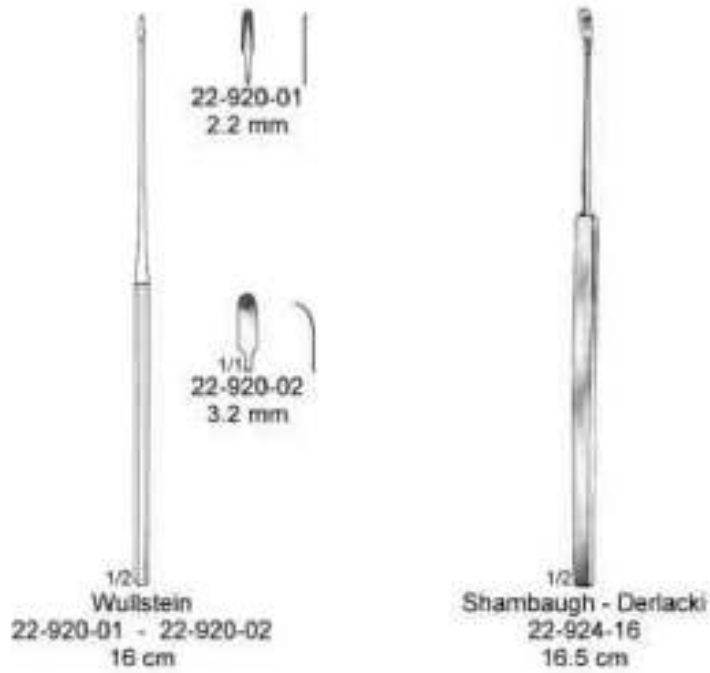



Otology - Otologie - Otologia
 Ear Syringes
 Ohrspritzen
 Jeringas para los oidos

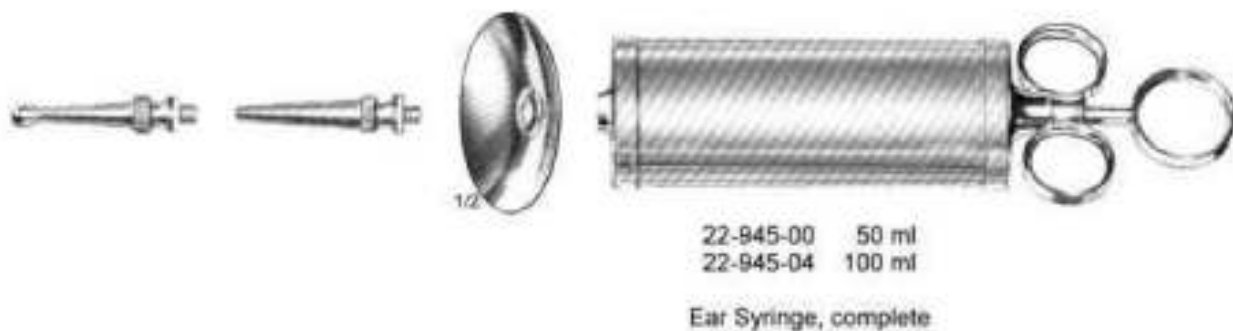
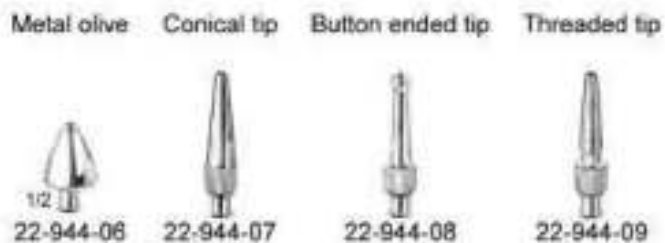

Rhinology - Rhinologie - Rinologia
Nasal Specula
Nasenspekula
Especulos nasales

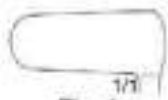

1/1
Fig. 1
 23-101-01
 21 x 9.5 mm



1/1
Fig. 2
 23-101-02
 21 x 10.5 mm



1/1
Fig. 3
 23-101-03
 21 x 11.5 mm



1/1
Fig. 1
 23-105-01



1/1
Fig. 2
 23-105-02



1/1
Fig. 3
 23-105-03



1/2
Thudicum (Goldsmith)
 23-101-01 - 23-101-03
 6.5 cm



1/2
Voltolini (Duplay)
 23-105-01 - 23-105-03



1/2
Hartmann - Halle
 23-109-01 - 23-109-03
 15 cm



1/1
Fig. 1
 23-109-01
 27 mm



1/1
Fig. 2
 23-109-02
 31 mm



1/1
Fig. 3
 23-109-03
 35 mm

Rhinology - Rhinologie - Rinologia
 Nasal Specula
 Nasenspekula
 Especulos nasales



Beckmann
 23-112-13
 13 cm



Beckmann
 23-113-13
 13 cm



Tieck - Halle
 23-116-01 - 23-116-02
 13.5 cm



Fig. 1
 23-116-01
 16 mm



Fig. 2
 23-116-02
 20 mm



Killian
 23-120-01 - 23-120-04
 13 cm

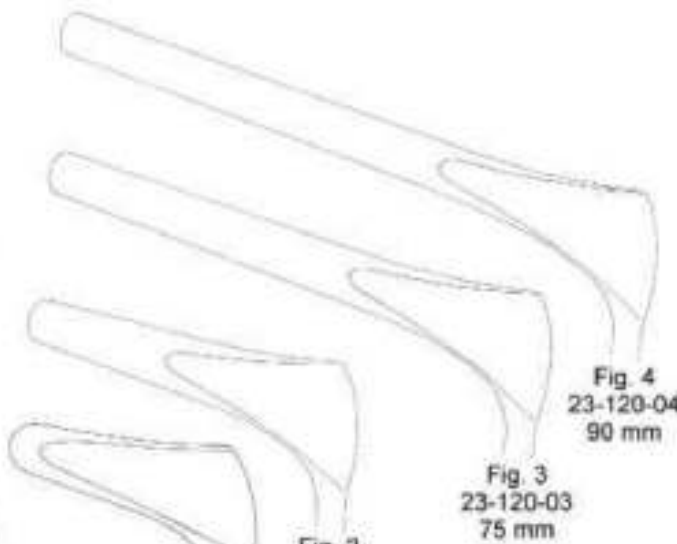

Mod. Wien
 23-122-14
 14.5 cm

Rhinology - Rhinologie - Rinologia
Nasal Specula
Nasenspekula
Especulos nasales

Dull black chromium plated



1/2
Cottle
23-125-01 - 23-125-02
14 cm

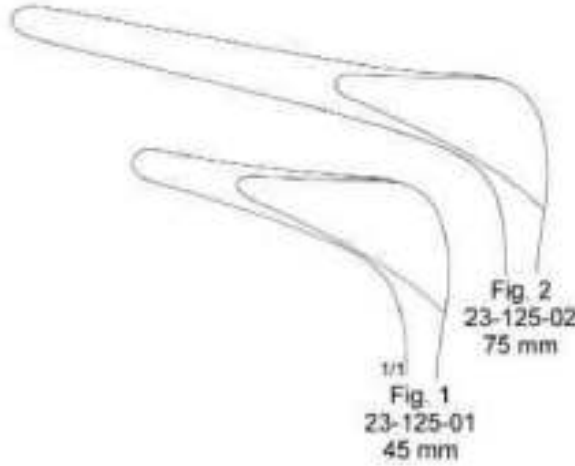

1/2
Cottle
23-127-01 - 23-127-04
15 cm

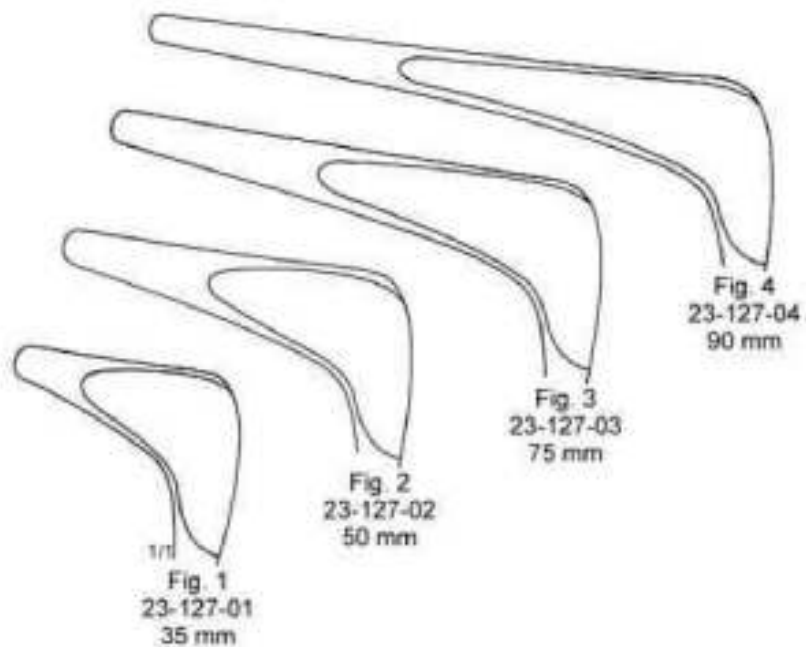



Rhinology - Rhinologie - Rinologia
Nasal Specula
Nasenspekula
Especulos nasales

with fixing screw



12
Cottle
23-131-01 - 23-131-04
15 cm

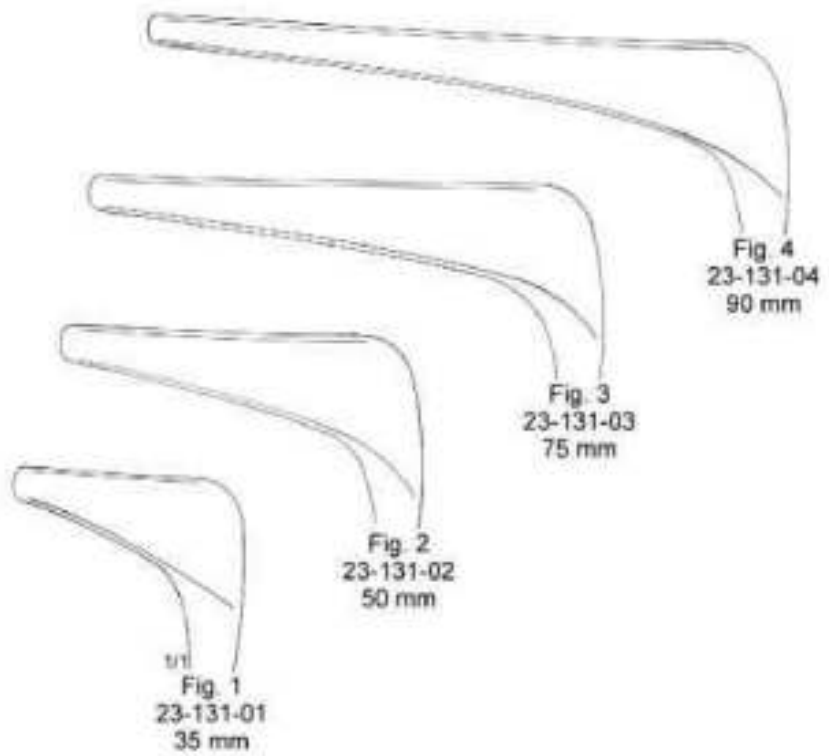

Rhinology - Rhinologie - Rinologia
Nasal Specula
Nasenspekula
Especulos nasales

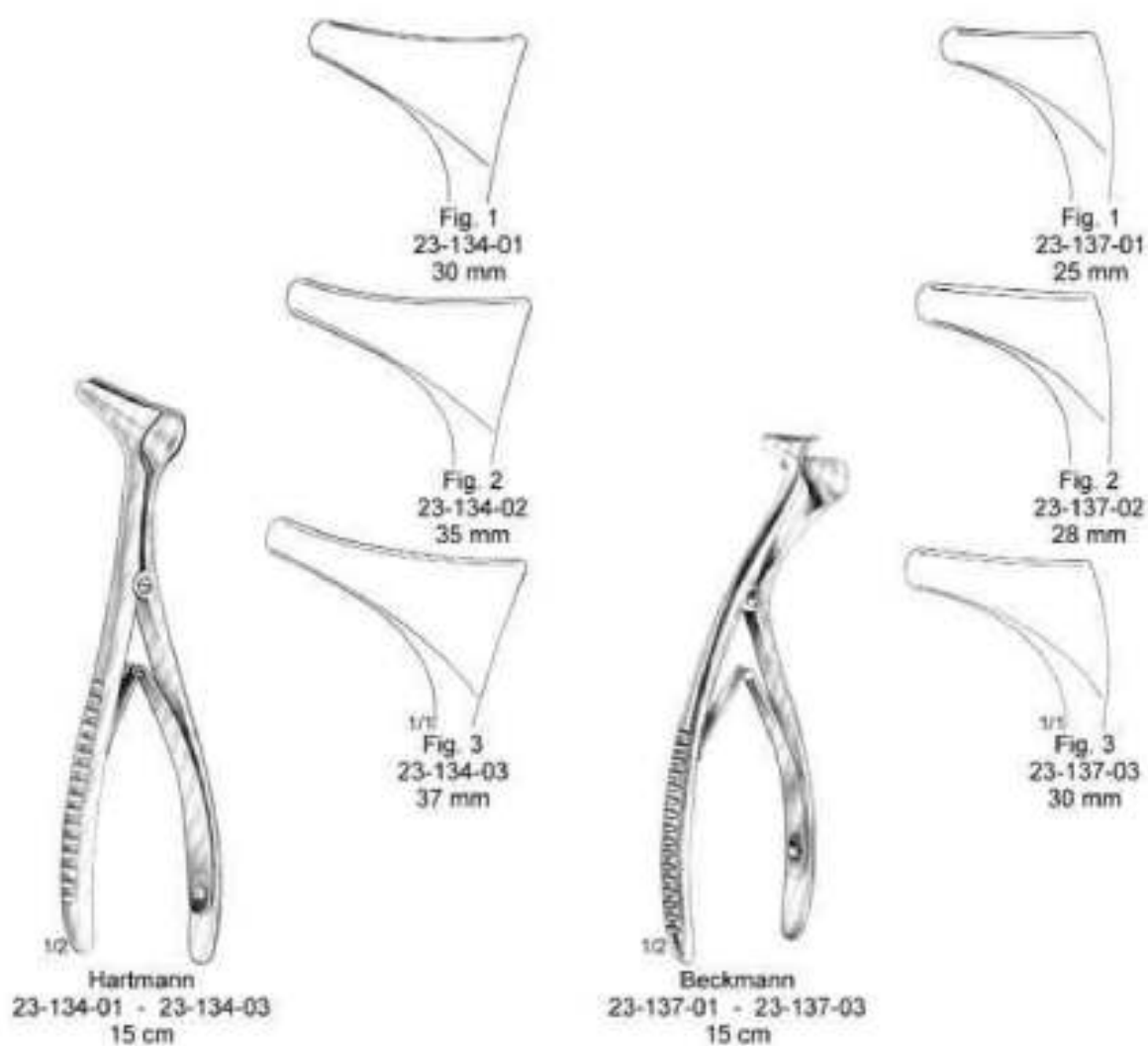



Rhinology - Rhinologie - Rinologia
Nasal Snares
Polypenschnurer
Polipotomos



1/2
Krause
23-161-26
26 cm



1/2
Krause - Voss
23-165-26
26 cm

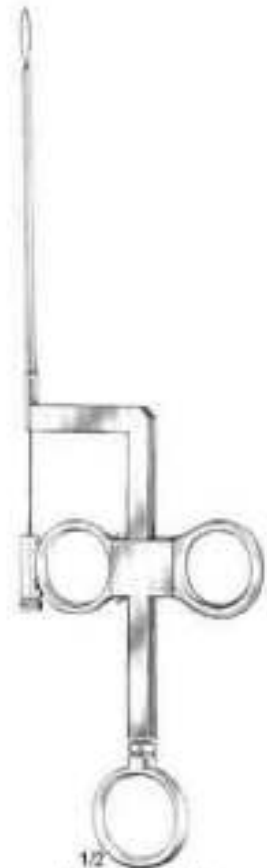

1/2
Lange - Wilde
23-169-24
24 cm



1/3
23-176-30 \varnothing 0.3 mm
23-176-40 \varnothing 0.4 mm

10 m / 33 ft

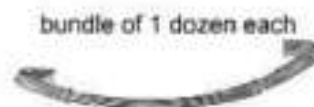

bundle of 1 dozen each
23-177-12
 \varnothing 0.3 mm

Rhinology - Rhinologie - Rinologia
Dressing and Tampon Forceps, Nasal Polypus Forceps
Tamponpinzetten und zangen, Polypen zangen
Pinzas para compresas y tamponamientos, Pinzas para polips

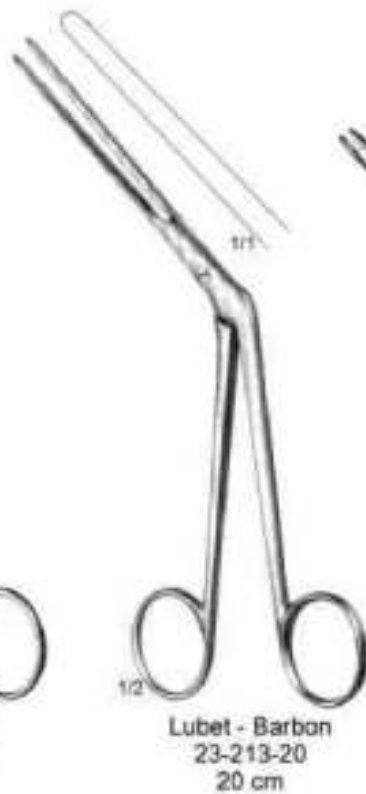
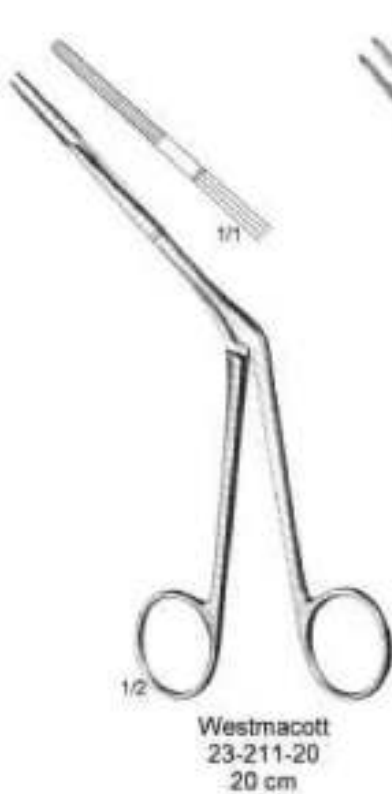

Rhinology - Rhinologie - Rinologia
Nasal Polypus and Septum Compression Forceps
Polypenzangen, Septumzangen
Pinzas para polipos, Pinzas para el tabique nasal



Hartmann
23-221-20
20 cm



Littauer
23-225-18
18 cm



Killian
23-229-17
17 cm



Heymann
23-235-01 - 23-235-03
18 cm



Knight
23-239-18
18 cm



Quire
23-231-12
12 cm



Rhinology - Rhinologie - Rinologia
Nasal Polypus and Septum Compression Forceps
Polypenzangen, Septumzangen
Pinzas para polipos, Pinzas para el tabique nasal



Graig
23-243-18
18 cm



Graig - Domnick
23-247-01 - 23-247-02
18 cm

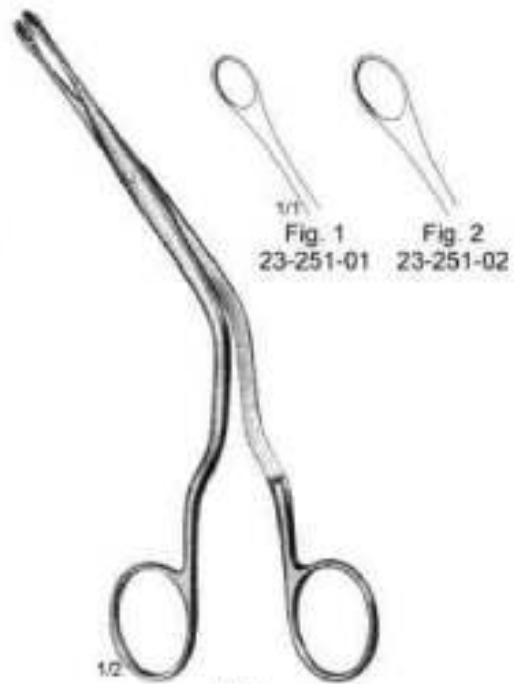

Luc
23-251-01 - 23-251-02
20 cm

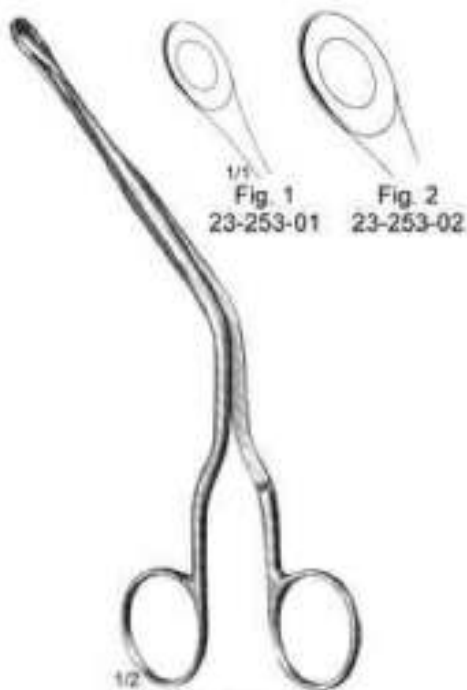

Luc
23-253-01 - 23-253-02
20 cm

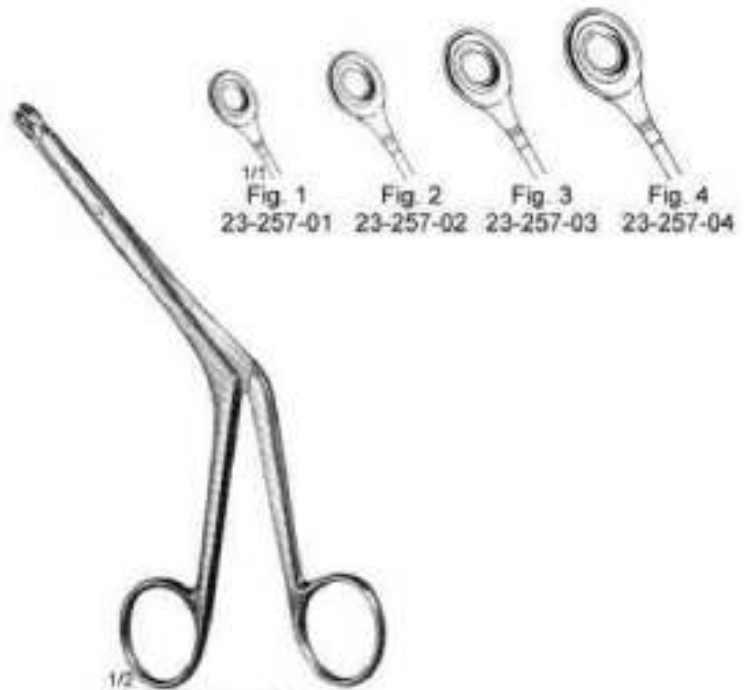

Bruenings
23-257-01 - 23-257-04
19 cm





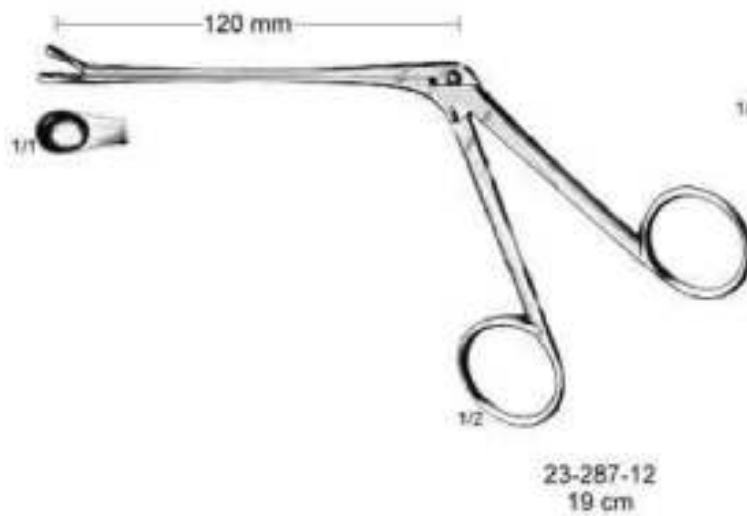
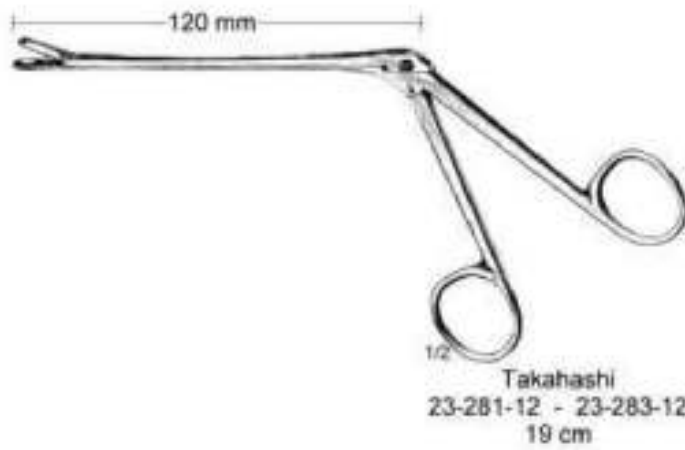



Rhinology - Rhinologie - Rinologia
Nasal Cutting Forceps
Scharfe Nasenzangen
Pinzas portantes para la nariz



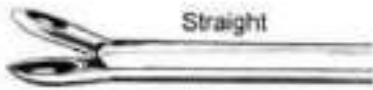

Rhinology - Rhinologie - Rinologia
Nasal Cutting Forceps
Scharfe Nasenzangen
Pinzas portantes para la nariz

					
	1/1 Fig. 1 3.0 mm	Fig. 2 3.5 mm	Fig. 3 4.5 mm	Fig. 4 5.0 mm	Fig. 5 5.5 mm
	23-301-01	23-301-02	23-301-03	23-301-04	23-301-05
	23-303-01	23-303-02	23-303-03	23-303-04	23-303-05
	23-305-01	23-305-02	23-305-03	23-305-04	23-305-05

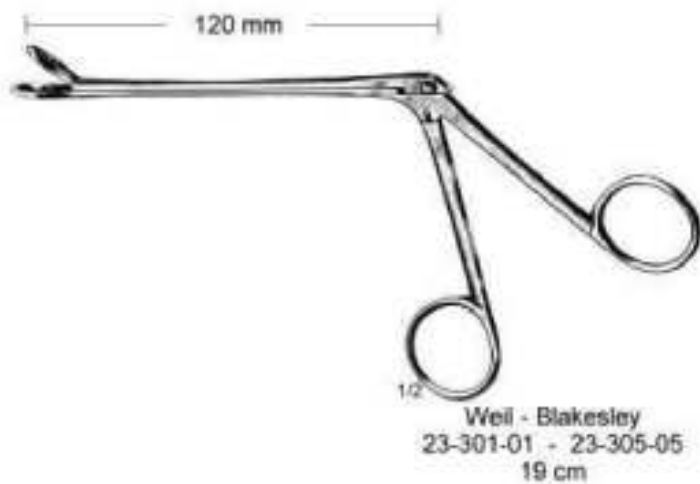

Rhinology - Rhinologie - Rinologia
Nasal Cutting Forceps
Scharfe Nasenzangen
Pinzas portantes para la nariz

-  23-311-05 5 mm
-  23-311-07 7 mm
-  23-311-09 9 mm
-  23-311-11 11 mm

-  23-315-01 5 x 2 mm
-  23-315-02 6 x 4 mm
-  23-315-03 8 x 4 mm

-  7 x 4 mm





Hartmann
23-311-05 - 23-311-11
19 cm



Gruenwald
23-315-01 - 23-315-03
19 cm



Gruenwald
23-317-01
19 cm

-  23-321-01 7 mm
-  23-321-02 9 mm
-  23-321-03 10 mm







Schmeden
23-321-01 - 23-321-03
19 cm

-  9 x 2 mm



Hajek
23-325-12
19 cm

-  23-329-01 9 x 2 mm
-  23-329-02 11 x 3 mm
-  23-329-03 12 x 4 mm
-  23-329-04 12 x 6 mm



Myles
23-329-01 - 23-329-04
19 cm

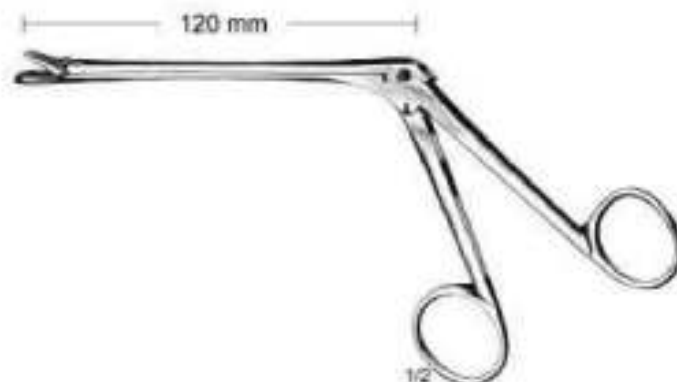

Rhinology - Rhinologie - Rinologia
Septum Compression Forceps
Septumzangen
Pinzas para el tubique nasal

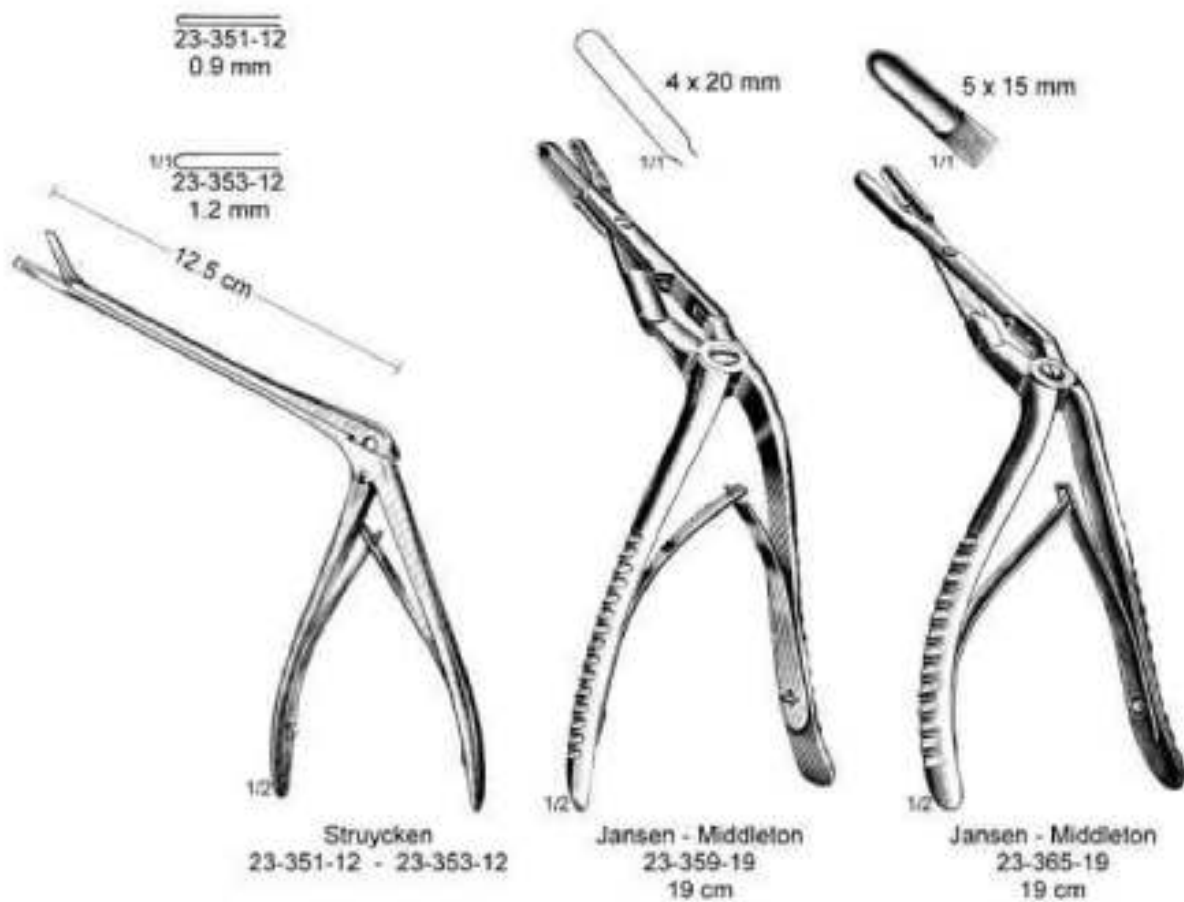

Rhinology - Rhinologie - Rinologia
Septum Scissors and Septum Forceps
Septumscheren und Septumzangen
Tijeras y pinzas de septum

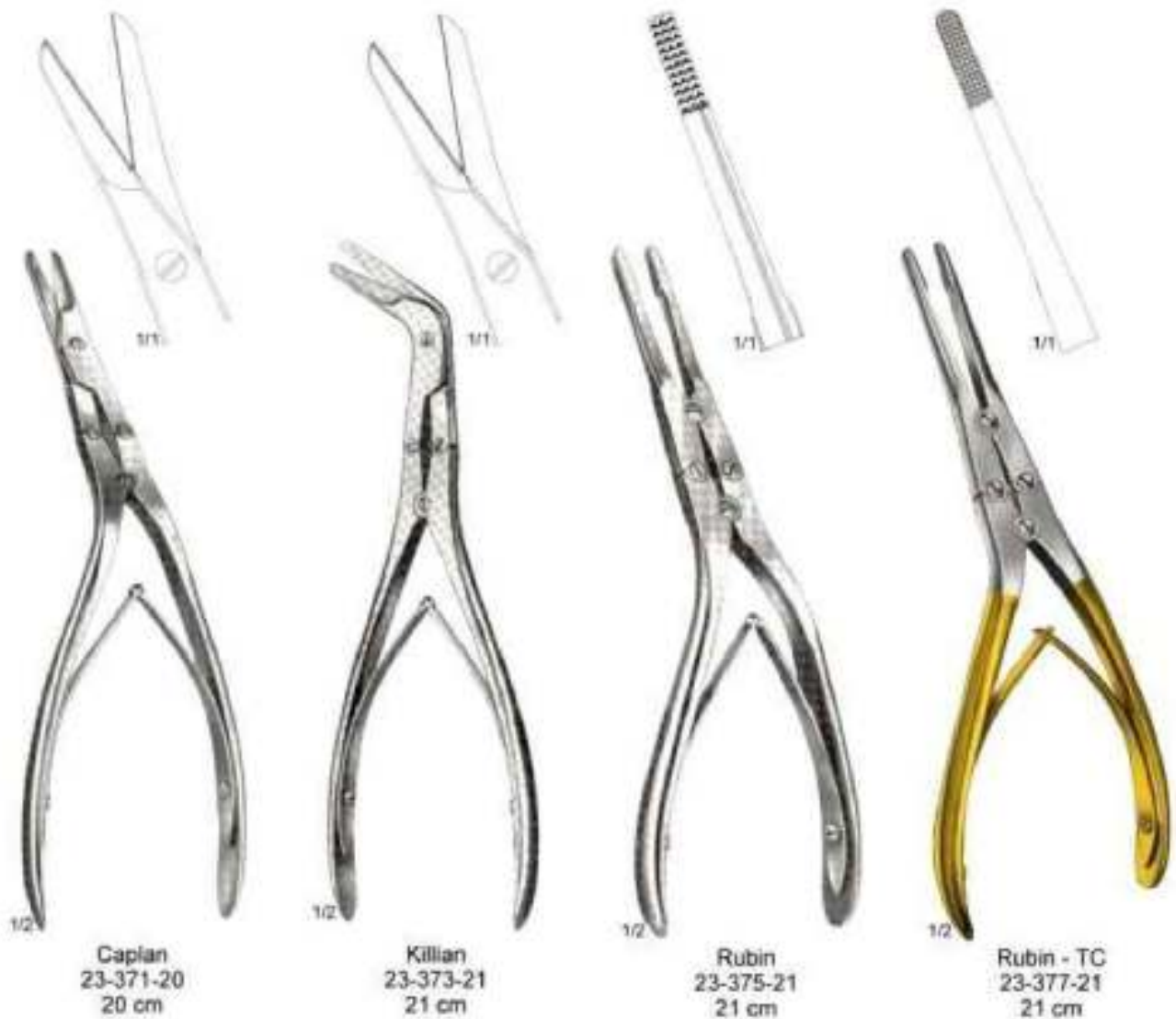

Rhinology - Rhinologie - Rinologia
Rhinoplastic Instruments
Instrumente zur Nasenplastik
Instrumentos para plastica nasal

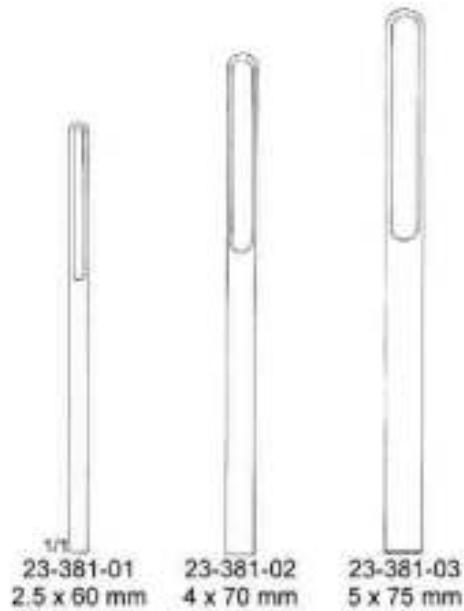

Rhinology - Rhinologie - Rinologia
Sphenoid Punches, Antrum Punch Forceps
Keilbeinstanzen, Kieferhohlenstanzen
Pinzas cortantes para seno esfenoidal y maxilar

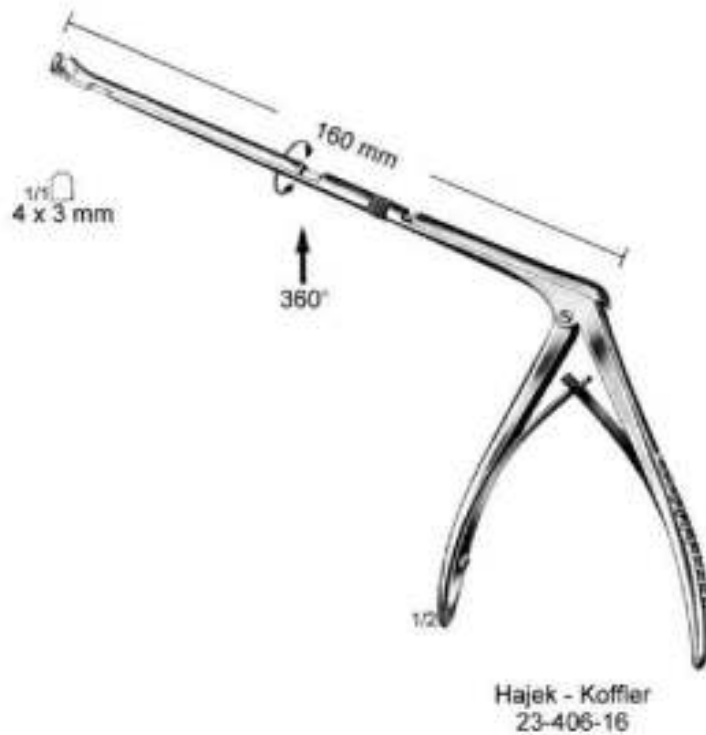
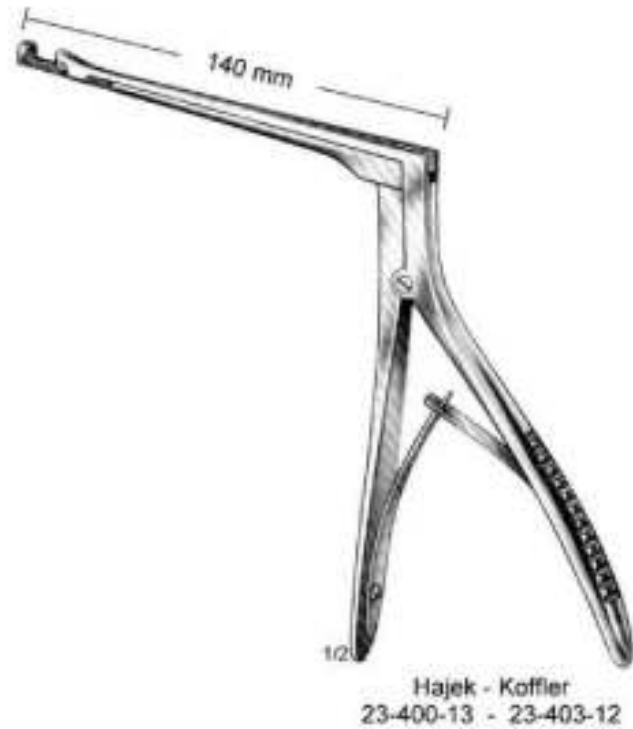
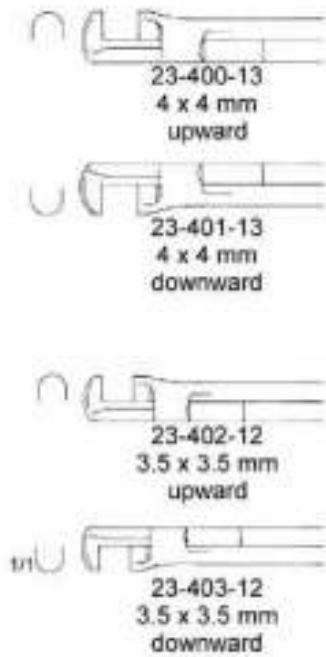

Rhinology - Rhinologie - Rinologia
Sphenoid Punches, Antrum Punch Forceps
Keilbeinstanzen, Kieferhohlenstanzen
Pinzas cortantes para seno esfenoidal y maxilar

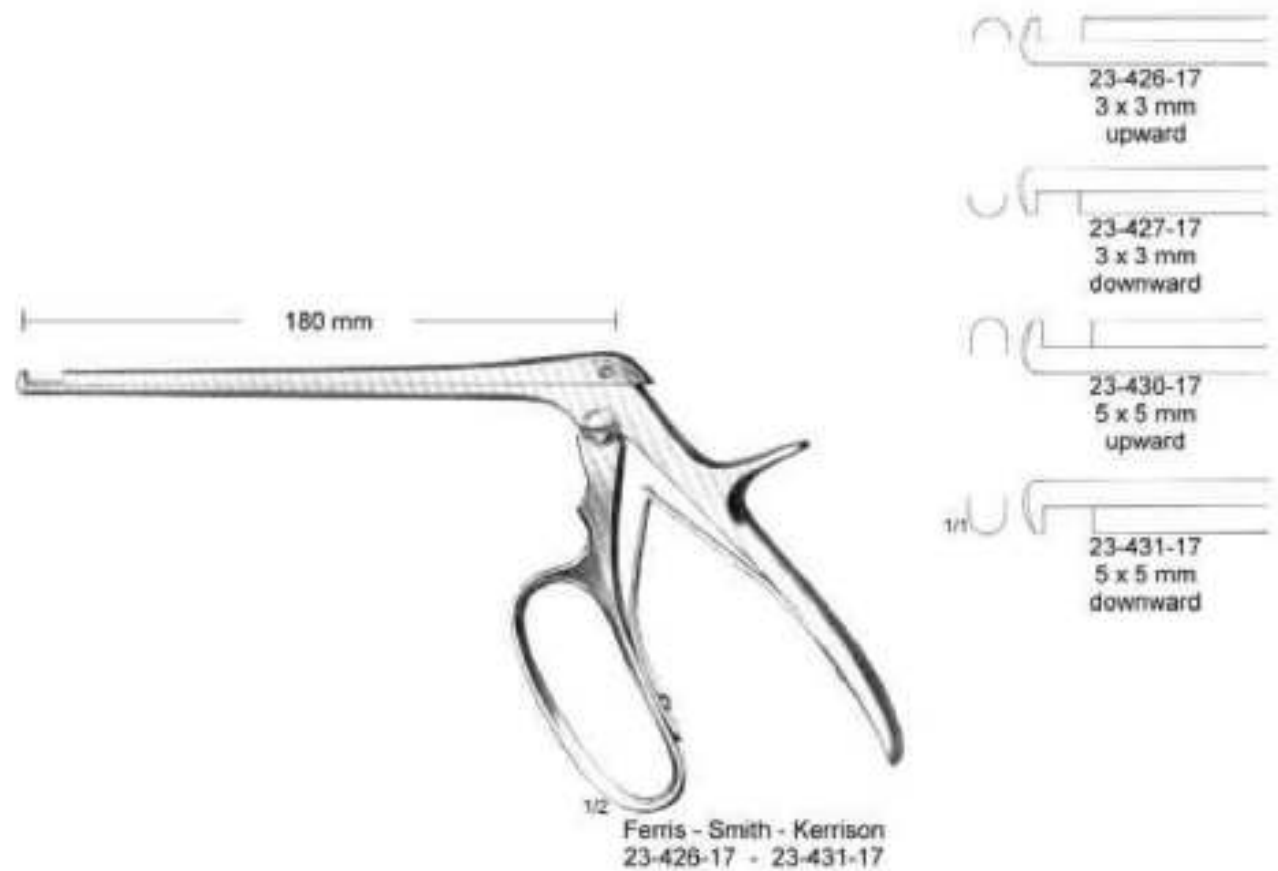
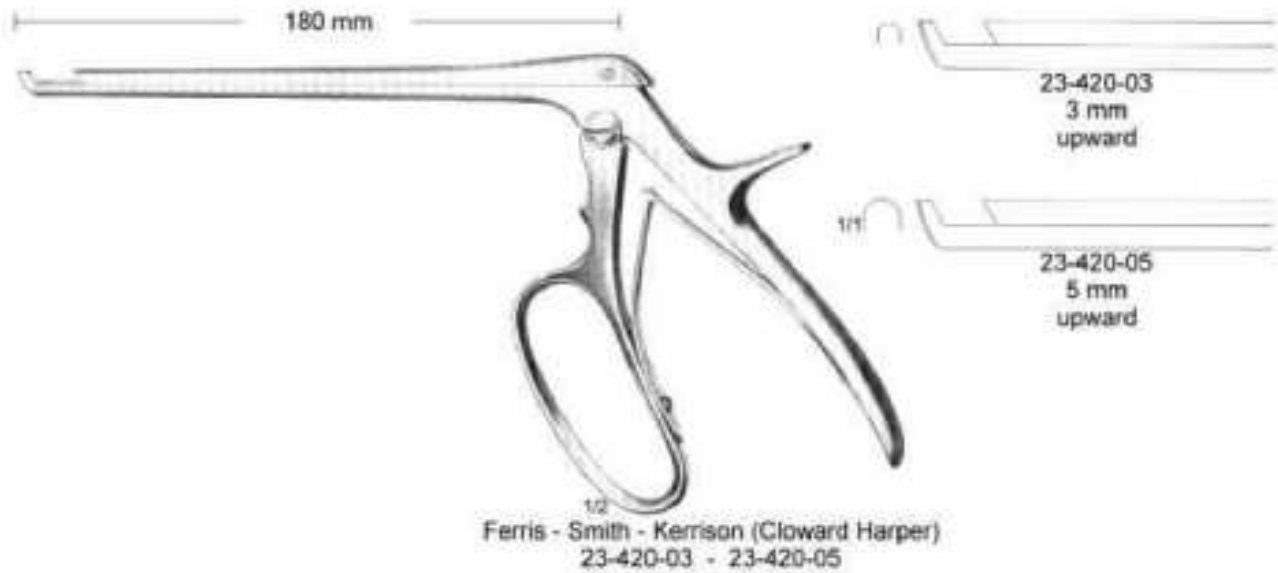



Rhinology - Rhinologie - Rinologia
Sphenoid Punches, Antrum Punch Forceps
Keilbeinstanzen, Kieferhohlenstanzen
Pinzas cortantes para seno esfenoidal y maxilar

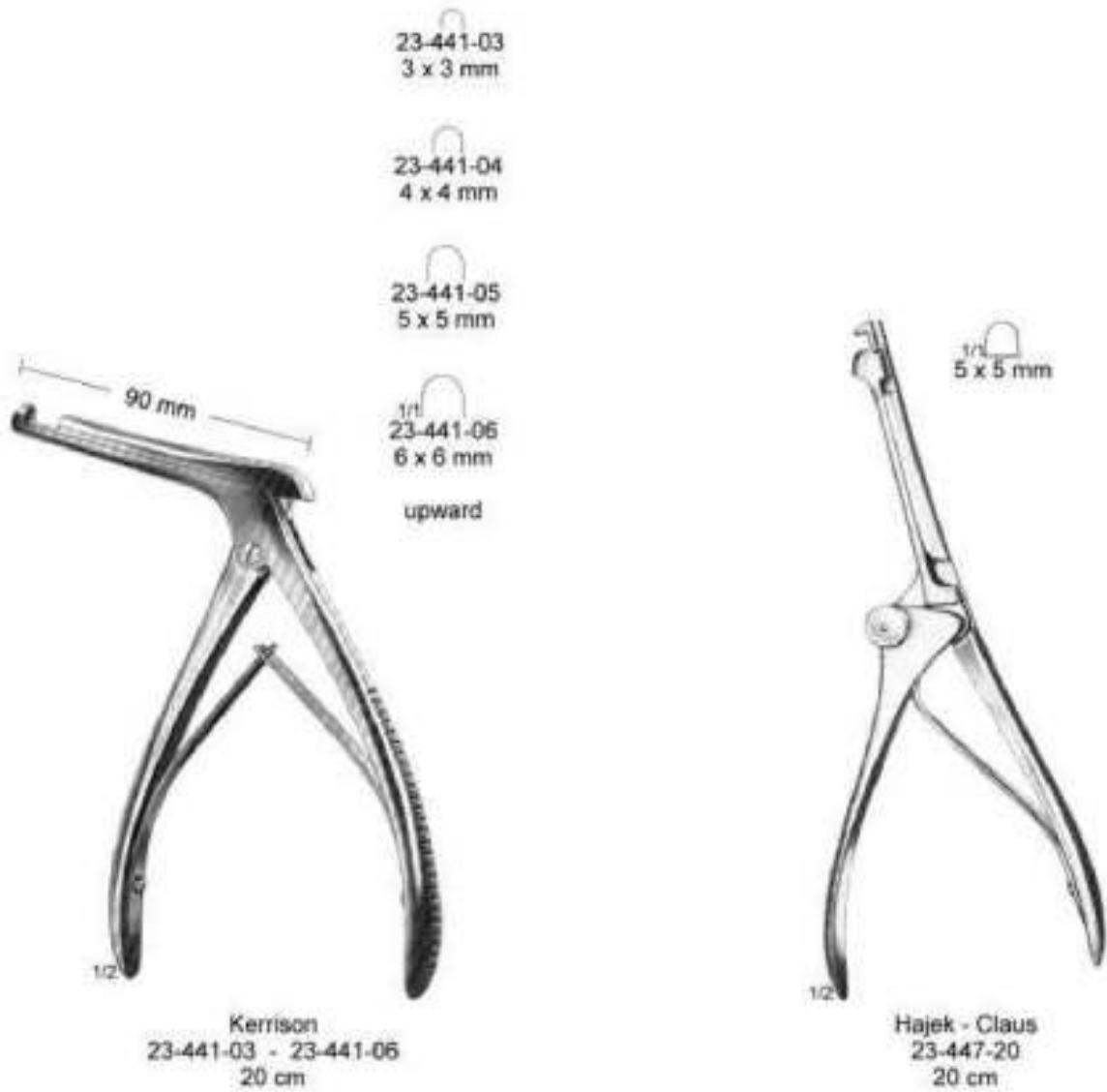

Rhinology - Rhinologie - Rinologia
Rhinoplastic and Nasal Knives
Nasenplastik-und Operationsmesser
Bisturies para operaciones de la nariz

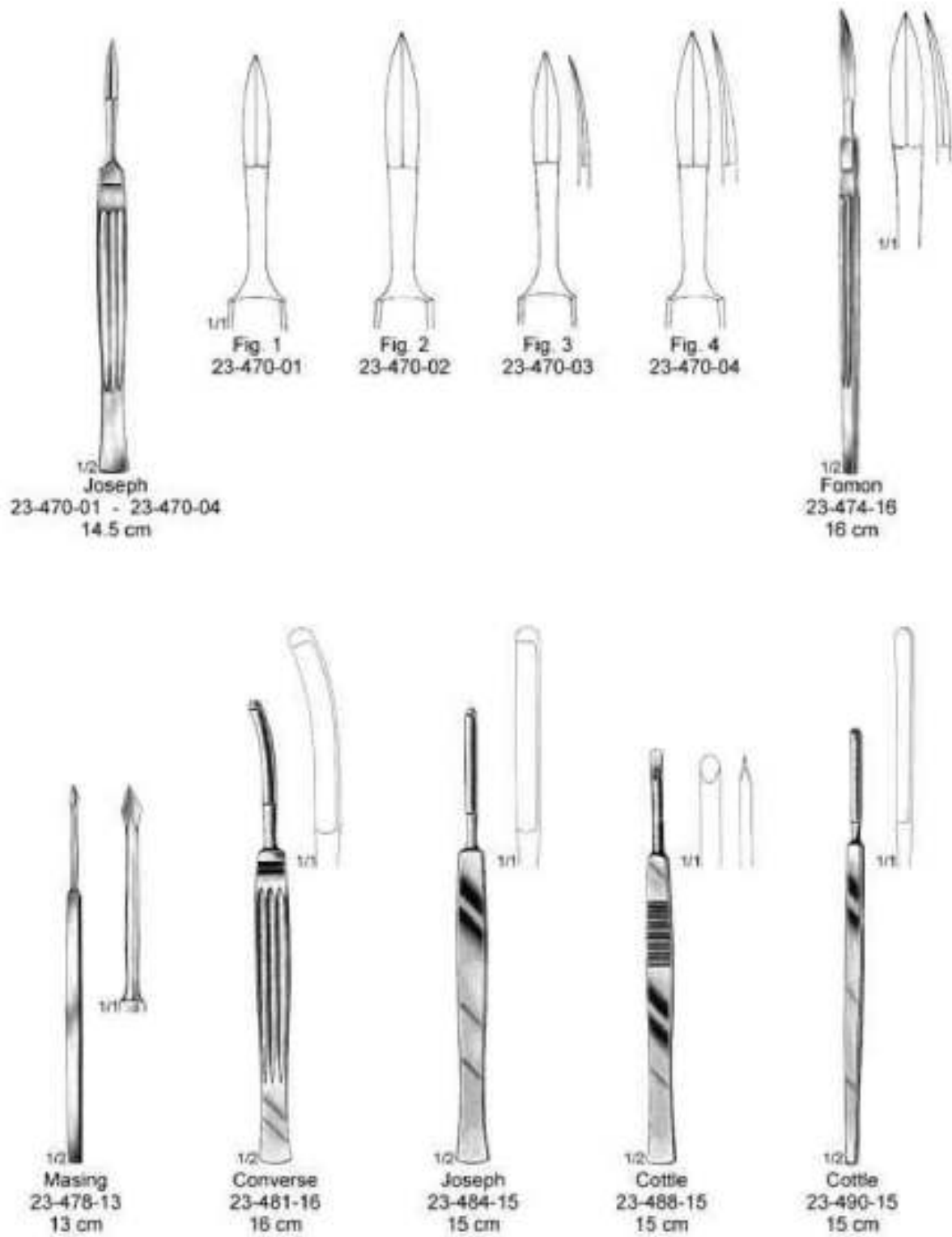

Rhinology - Rhinologie - Rinologia
 Septum Knives
 Septummesser
 Bisturios para el tabique nasal

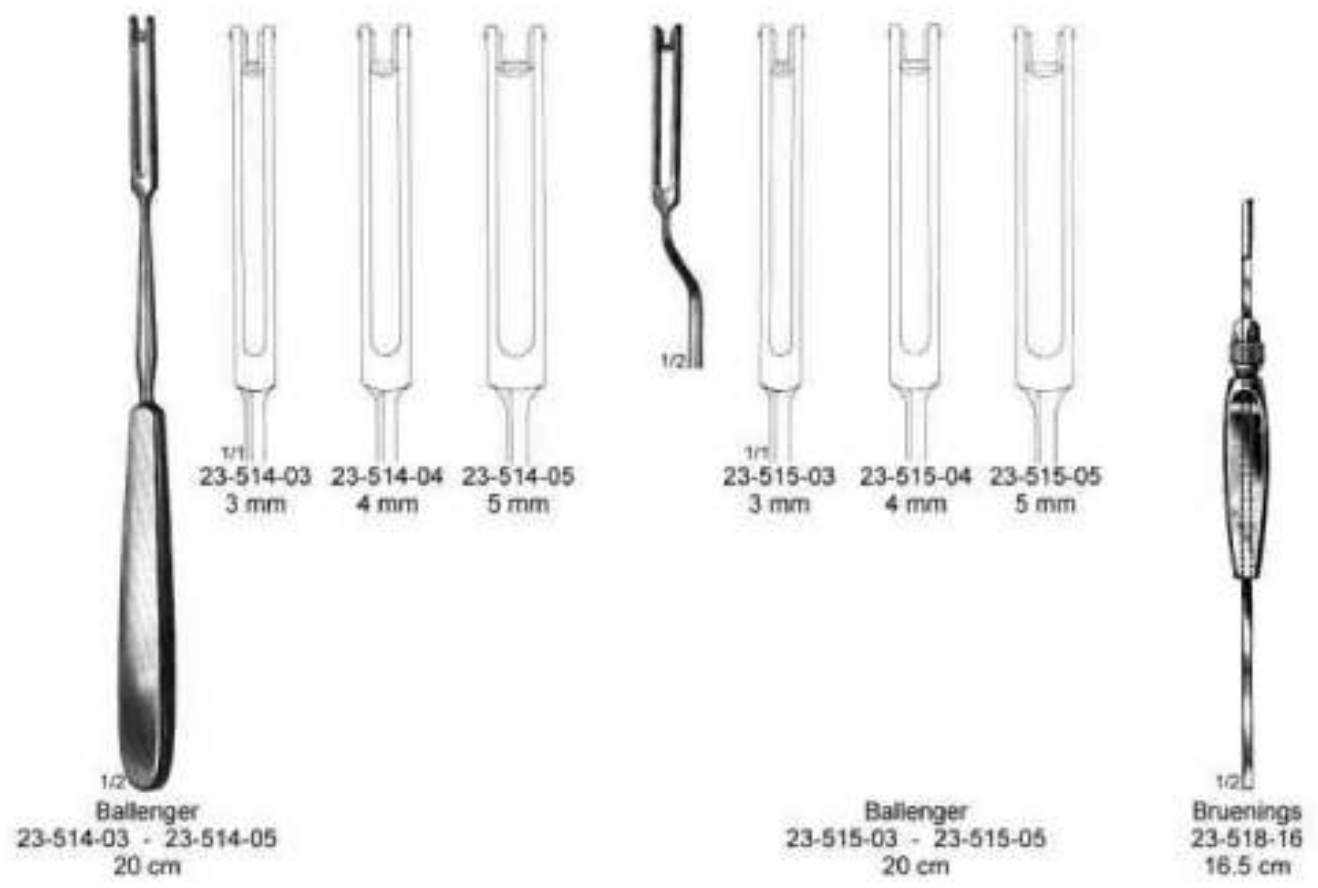



Rhinology - Rhinologie - Rinologia
Rhinoplastic and Nasal Knives
Nasenplastik-und Operationsmesser
Bisturies para operaciones de la nariz

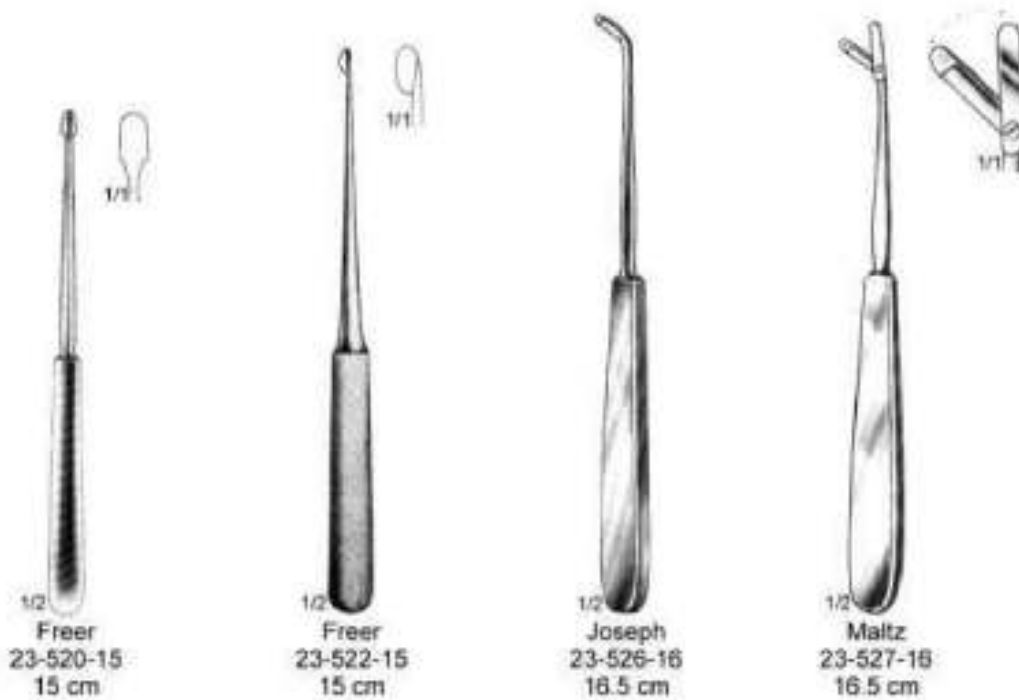

Rhinology - Rhinologie - Rinologia
Septum Elevators
Septum - Elevatorien
Elevadores y Espatulas para el tabique nasal

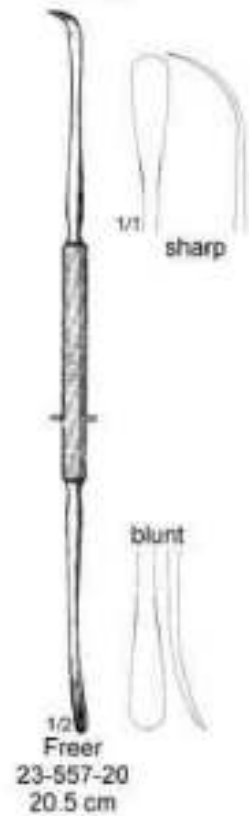

Rhinology - Rhinologie - Rinologia
Septum and Periosteal Elevators
Septum-und Periost - Elevatorien
Elevadores para el tabique nasal y para el periostio

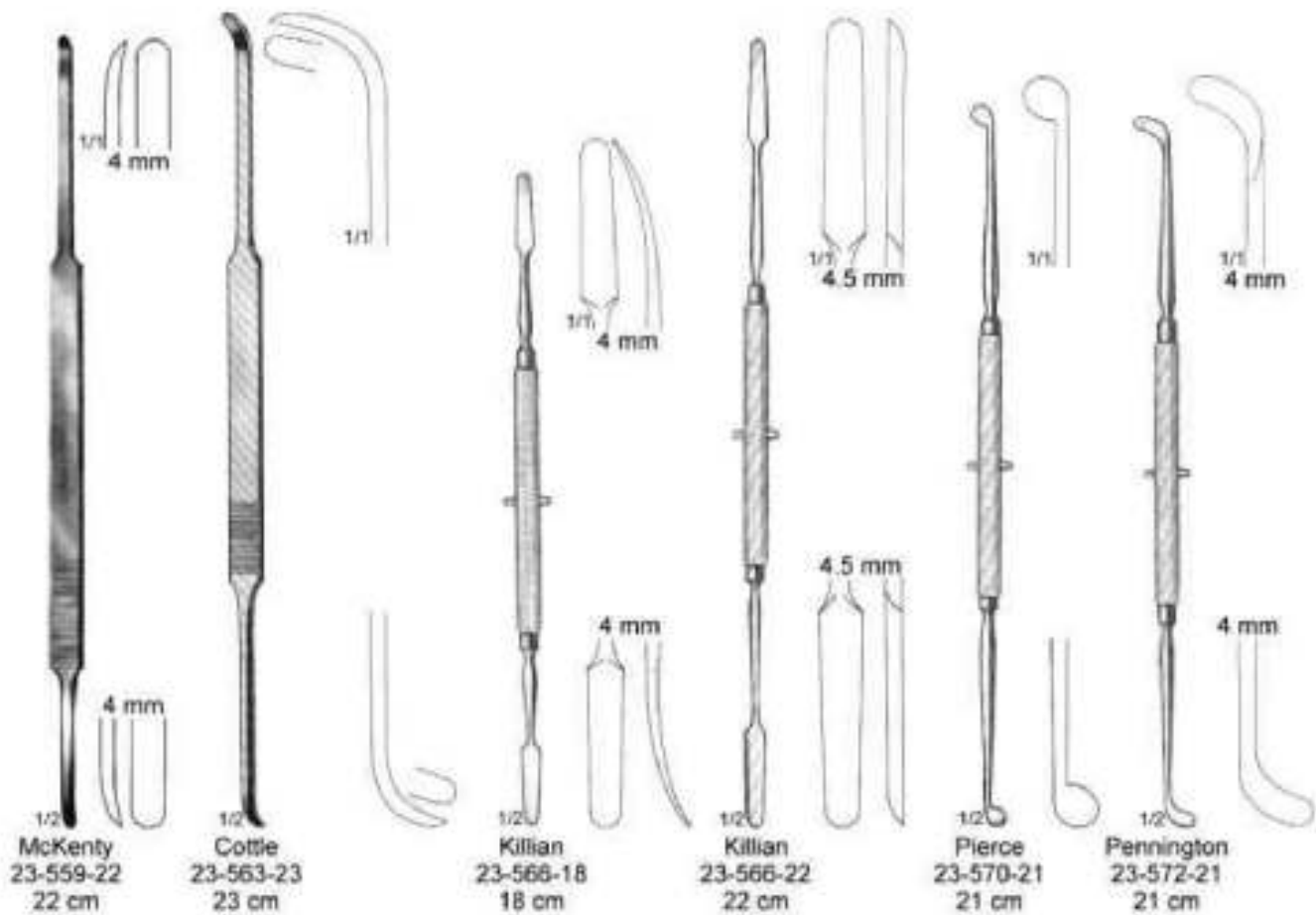

Rhinology - Rhinologie - Rinologia
Septum and Periosteal Elevators
Septum-und Periost - Elevatorien
Elevadores para el tabique nasal y para el periostio

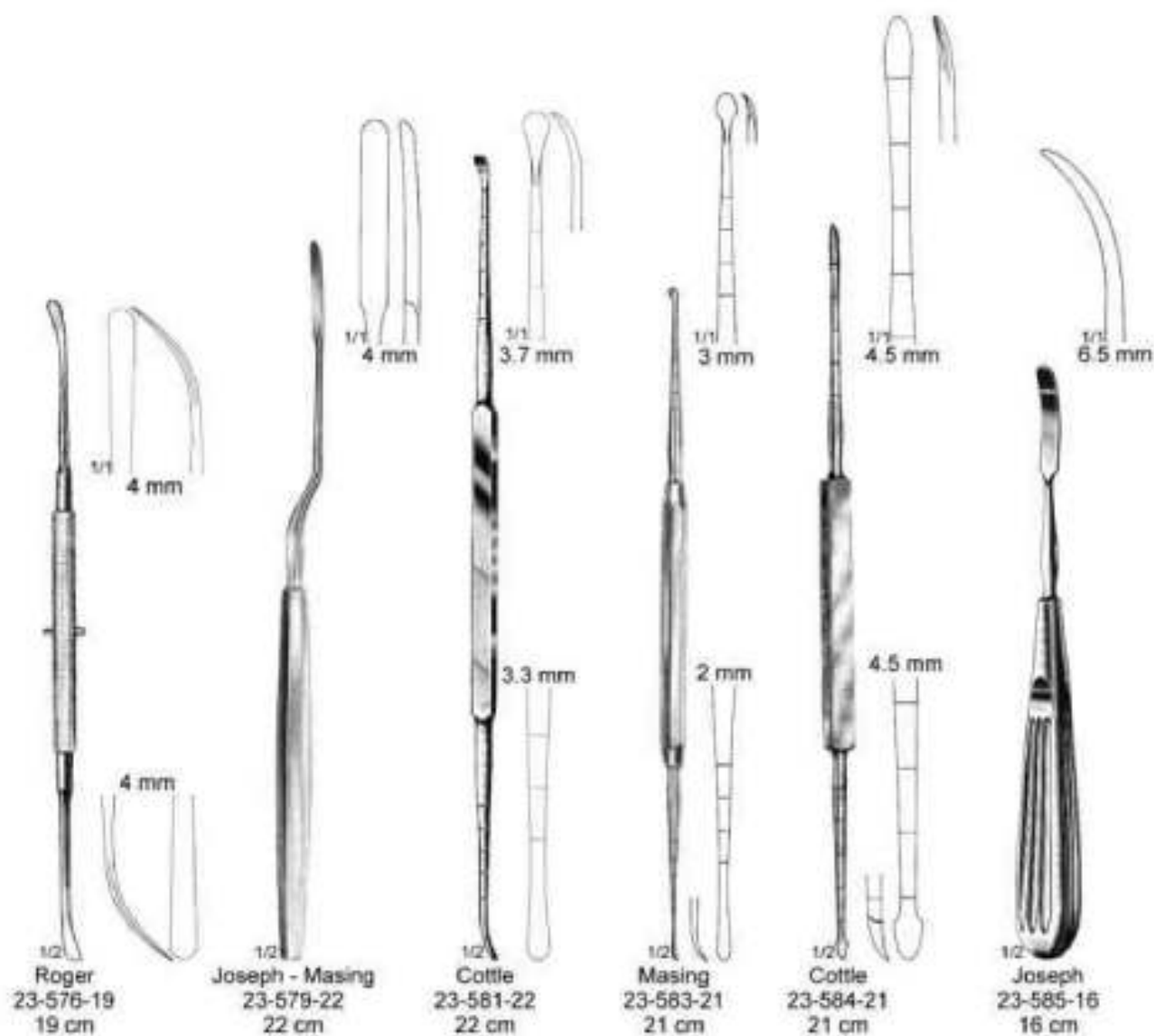



Rhinology - Rhinologie - Rinologia
Rhinoplastic Instruments etc.
Instrumente zur Nasenplastik usw.
Instrumentos para la plastica nasal etc.





Rhinology - Rhinologie - Rinologia
Chisels and Gouges
Flach-und Hohlmeißel
Cinceles y Gubias



Rhinology - Rhinologie - Rinologia
Osteotomes and Chisels
Osteotome und Flachmeißel
Osteotomos y Cinceles

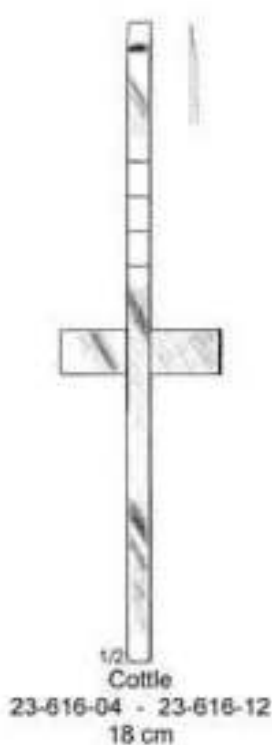
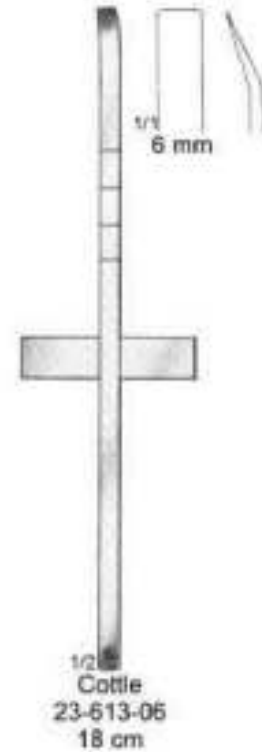
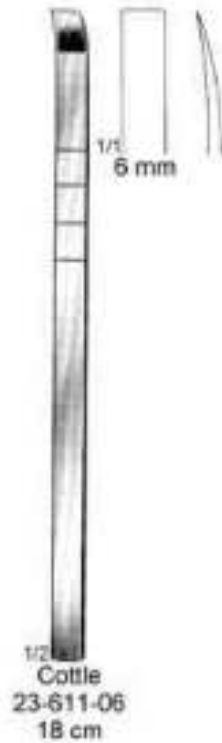
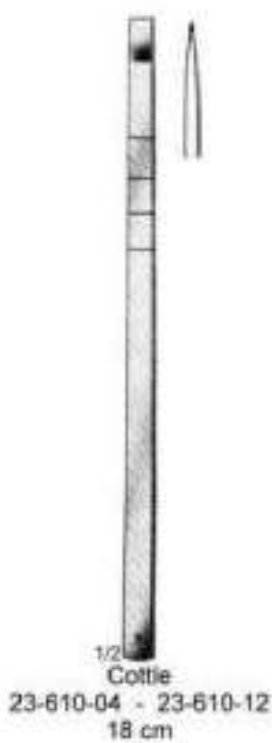

Rhinology - Rhinologie - Rinologia
Osteotomes and Chisels
Osteotome und Flachmeißel
Osteotomos y Cinceles

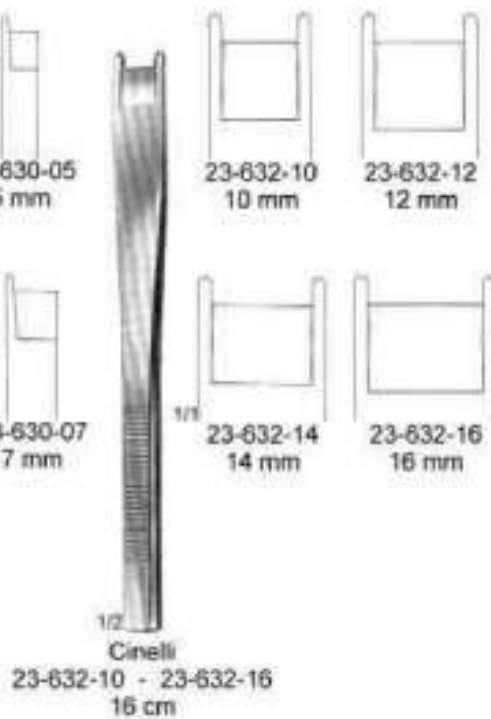
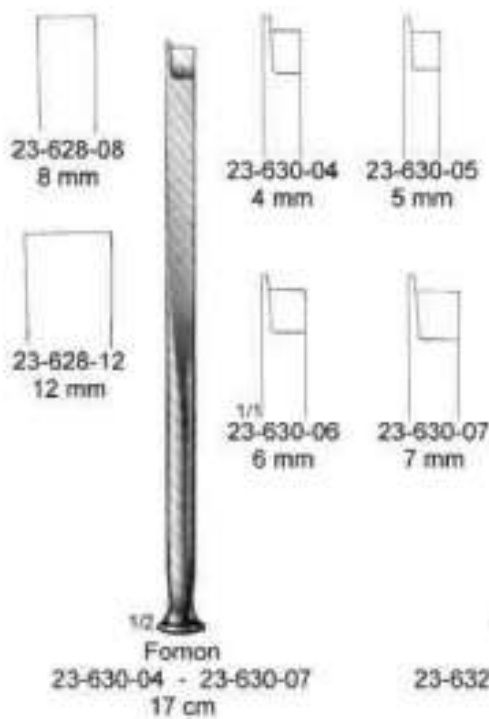
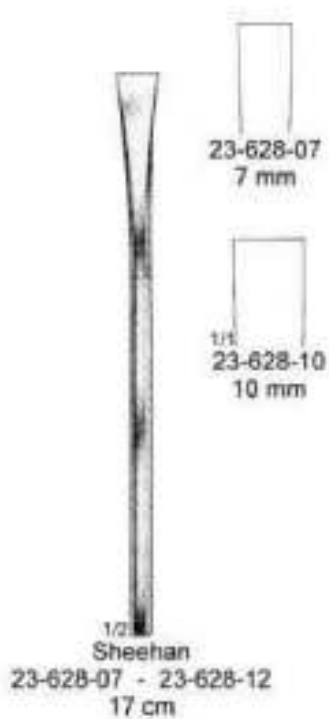
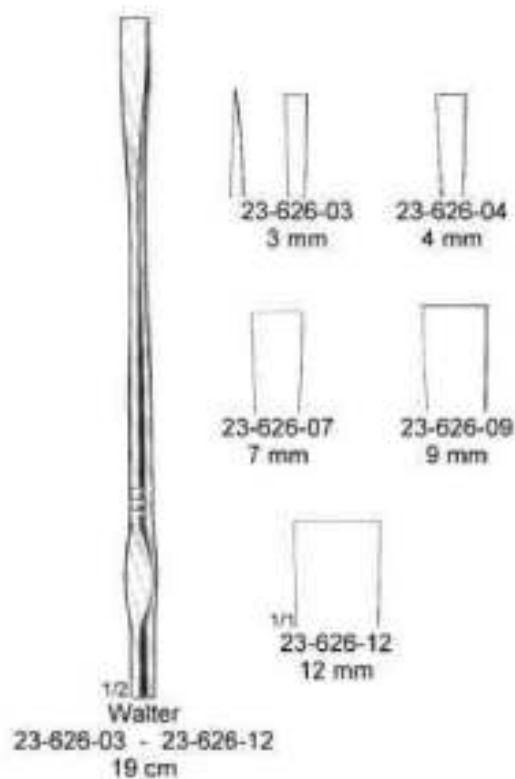
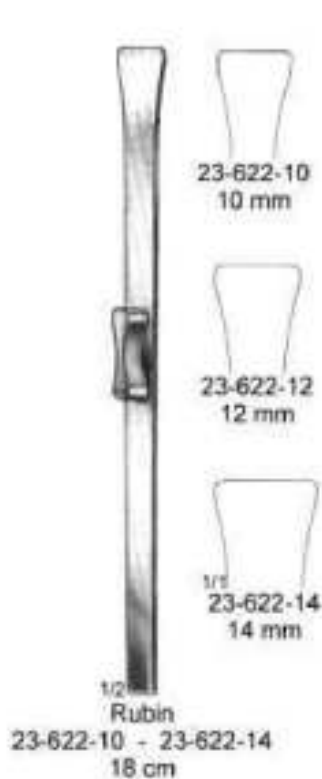

Rhinology - Rhinologie - Rinologia
Rhinoplastic Instruments etc.
Instrumente zur Nasenplastik usw.
Instrumentos para la plastica nasal etc.

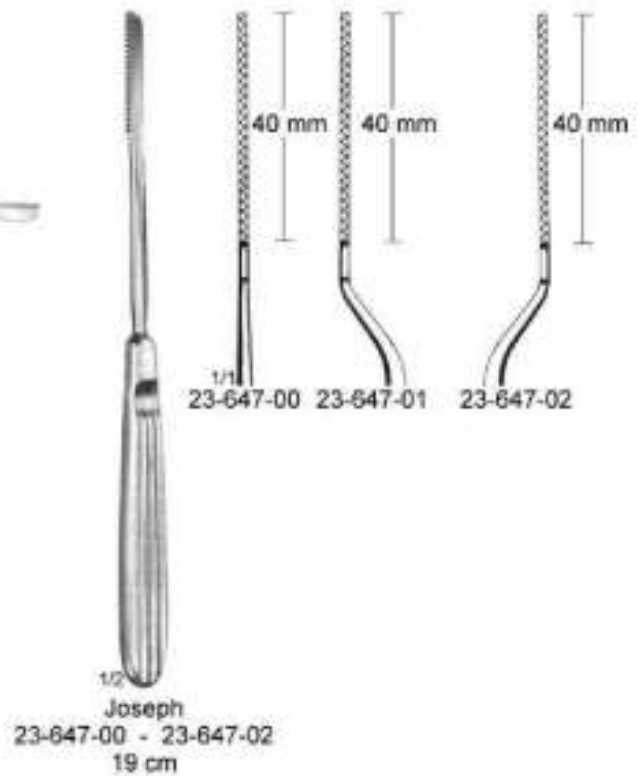
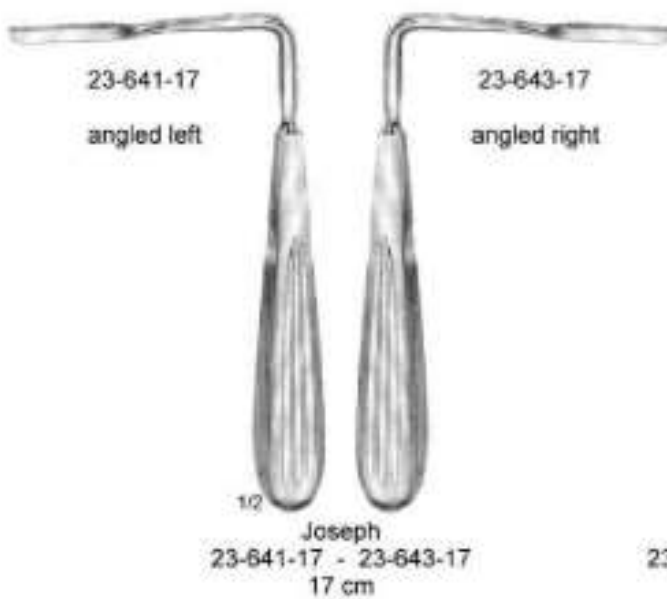
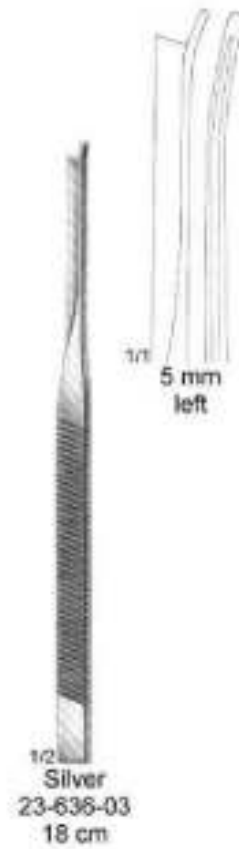
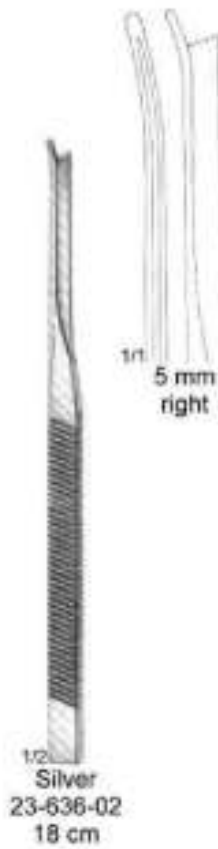
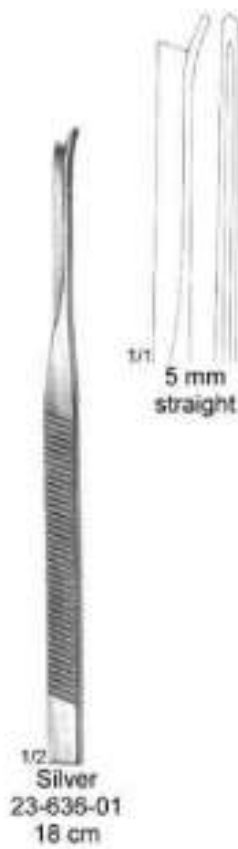

Rhinology - Rhinologie - Rinologia
Osteotomes and Chisels
Osteotome und Flachmeißel
Osteotomos y Cinceles

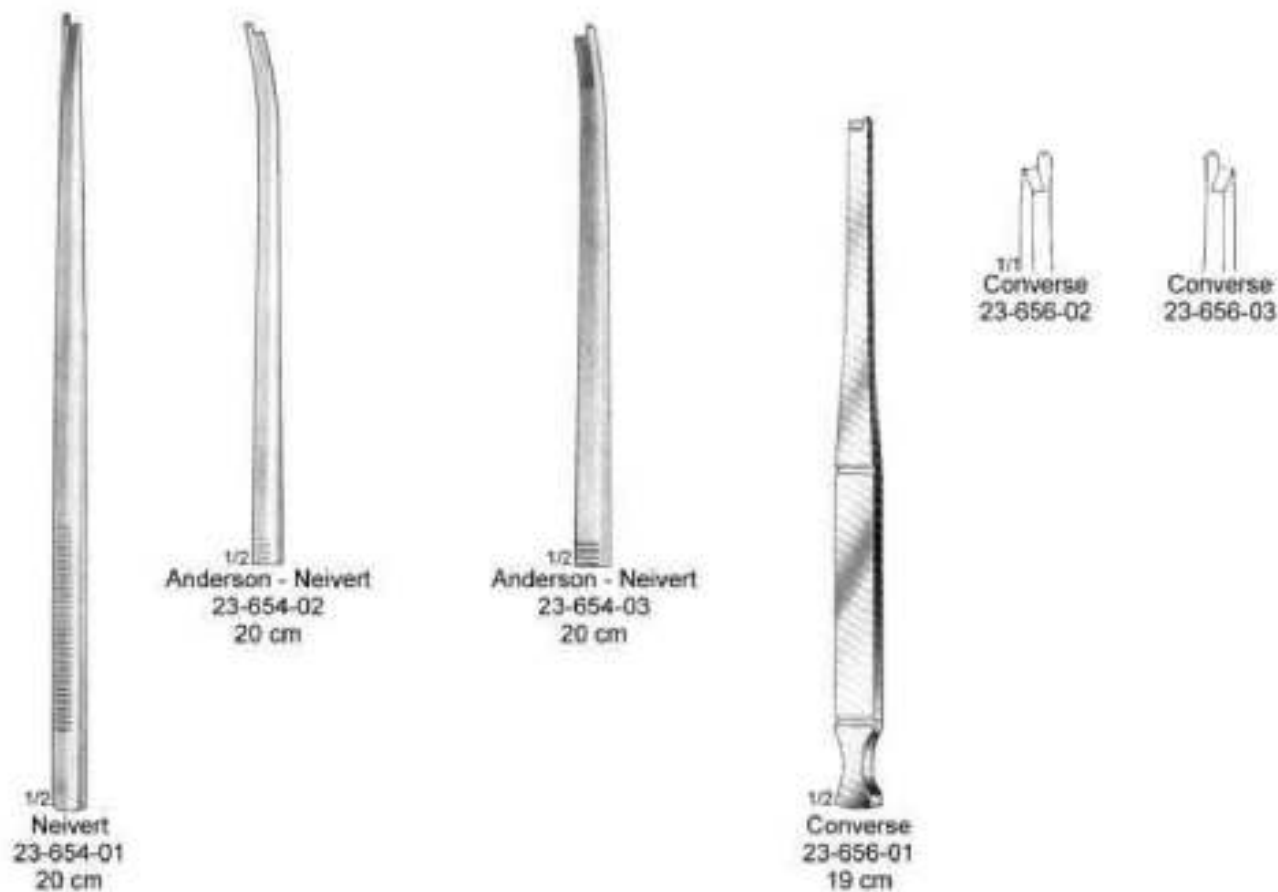
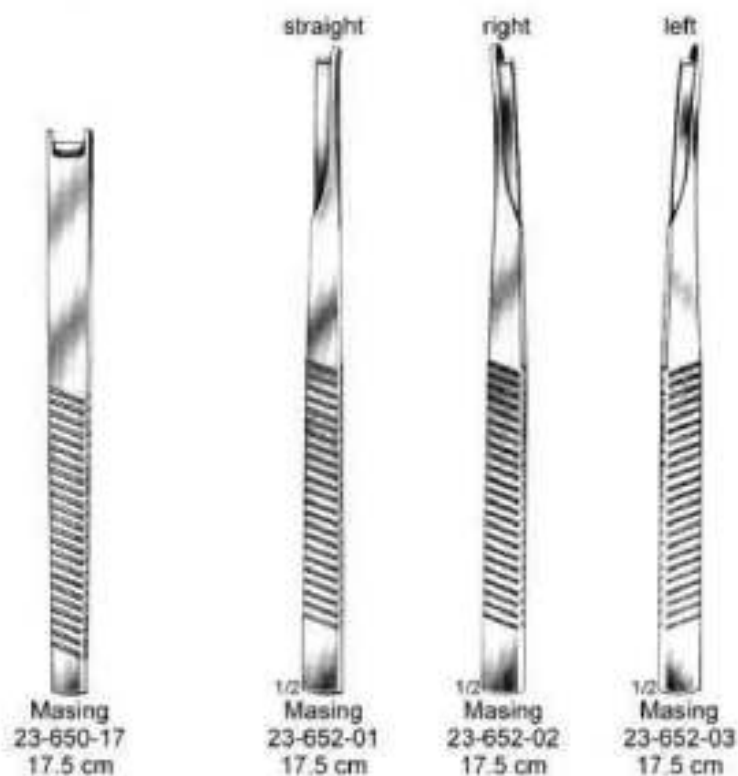



Rhinology - Rhinologie - Rinologia
Rhinoplastic Instruments etc.
Instrumente zur Nasenplastik usw.
Instrumentos para la plastica nasal etc.

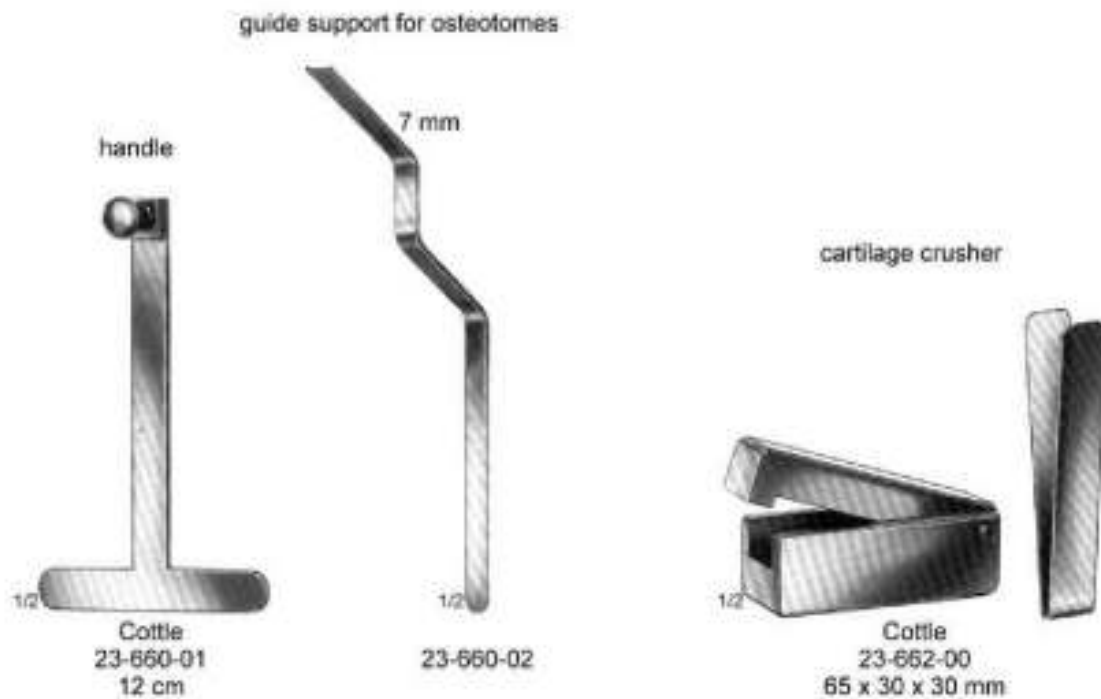

Rhinology - Rhinologie - Rinologia
Rhinoplastic Instruments etc.
Instrumente zur Nasenplastik usw.
Instrumentos para la plastica nasal etc.

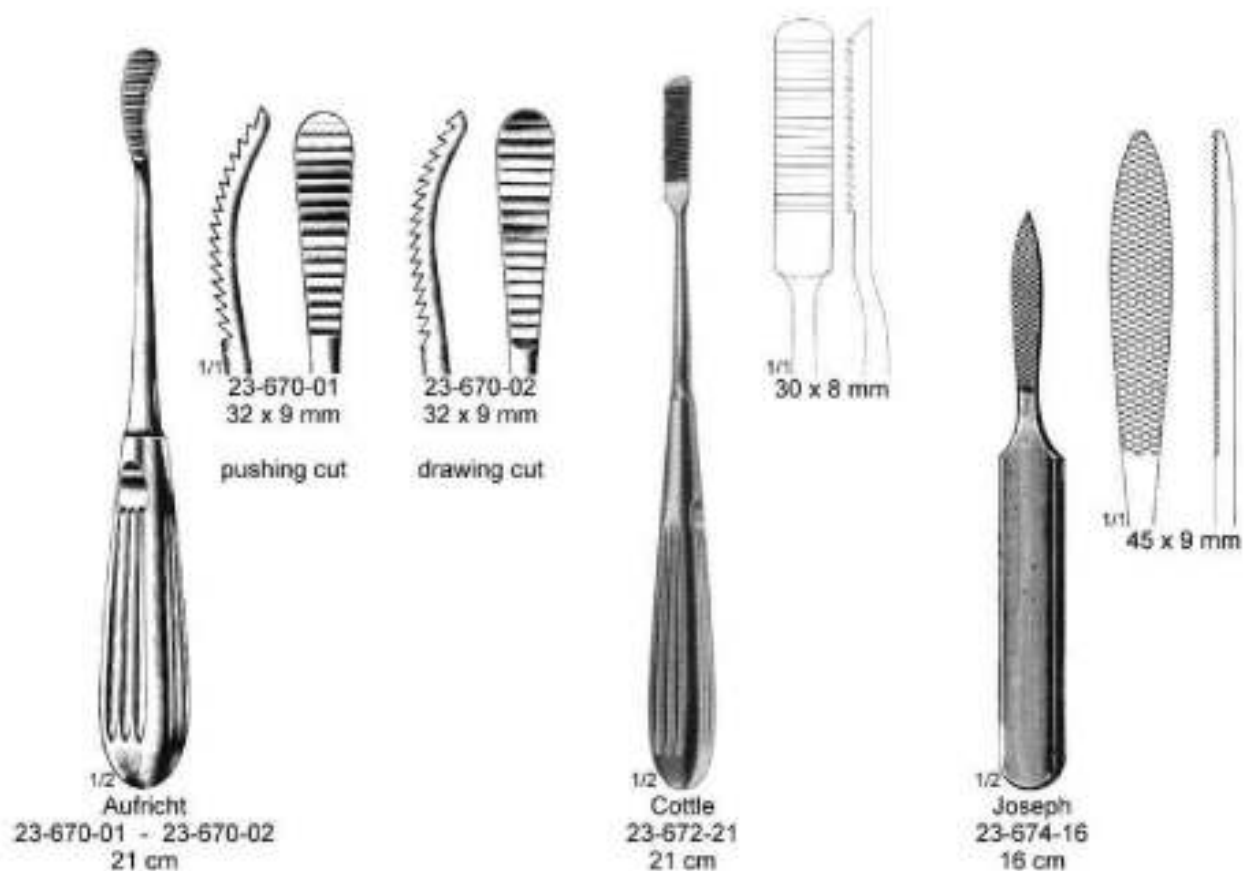
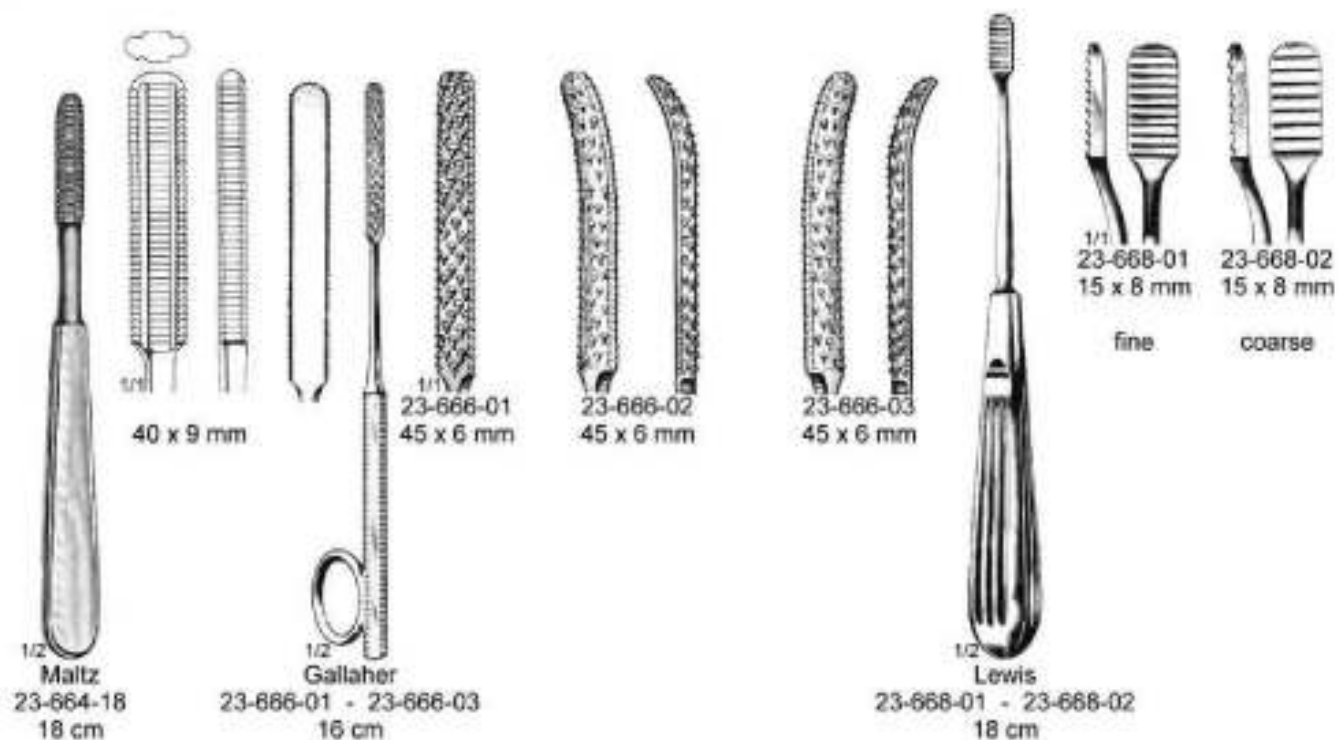



Rhinology - Rhinologie - Rinologia
Rhinoplastic Instruments etc.
Instrumente zur Nasenplastik usw.
Instrumentos para la plastica nasal etc.





Rhinology - Rhinologie - Rinologia
Nasal Rasps
Naserraspein
Escofinas nasal

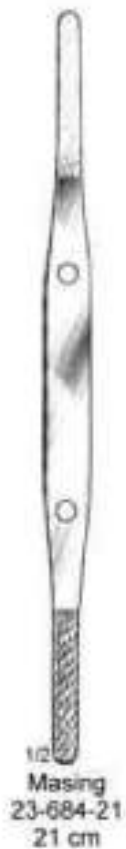



Rhinology - Rhinologie - Rinologia
Nasal Rasps
Nasenraspeln
Escofinas nasal



1/2
Miller - Colburn
23-688-01 - 23-688-05
19 cm



Fig. 1
23-688-01



Fig. 2
23-688-02



Fig. 3
23-688-03



Fig. 4
23-688-04



Fig. 5
23-688-05



1/2
Miller - Colburn
23-690-01 - 23-690-05
19 cm



Fig. 1
23-690-01



Fig. 2
23-690-02



Fig. 3
23-690-03



Fig. 4
23-690-04

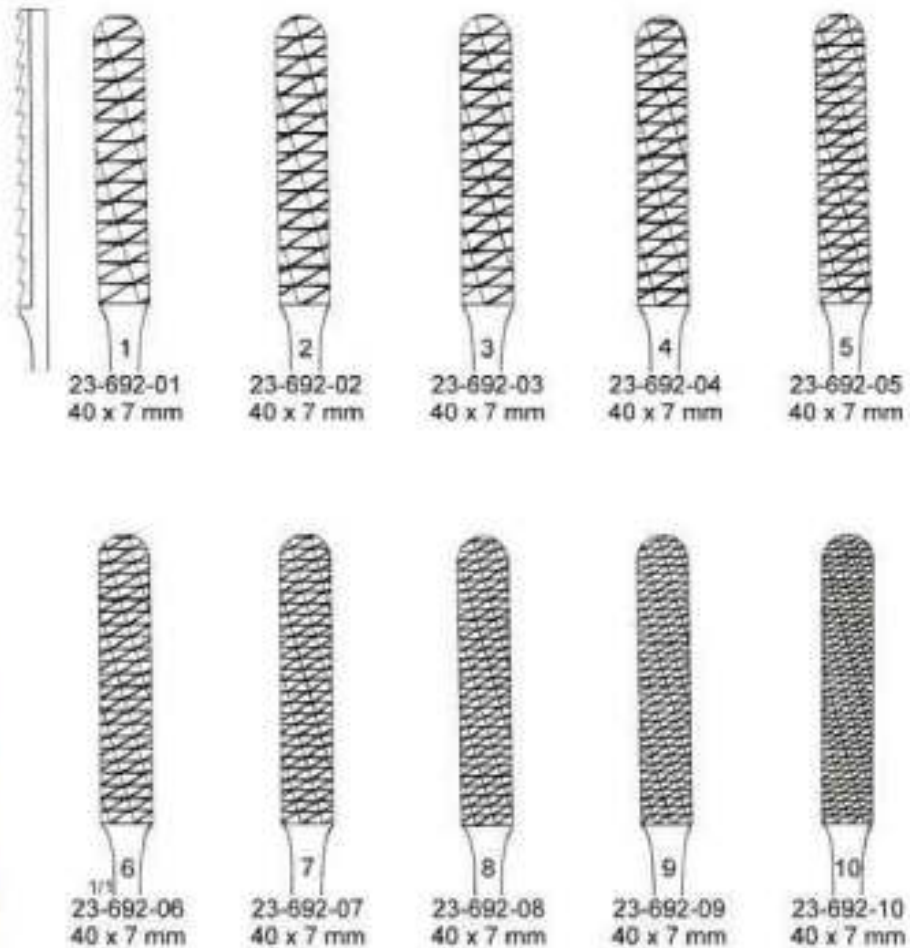

Fig. 5
23-690-05





Rhinology - Rhinologie - Rinologia
Rhinoplastic Instruments etc.
Instrumente zur Nasenplastik usw.
Instrumentos para la plastica nasal etc.



1/2
Maltz - TC
23-692-01 - 23-692-10
19.5 cm



Rhinology - Rhinologie - Rinologia
Rhinoplastic Instruments etc.
Instrumente zur Nasenplastik usw.
Instrumentos para la plastica nasal etc.

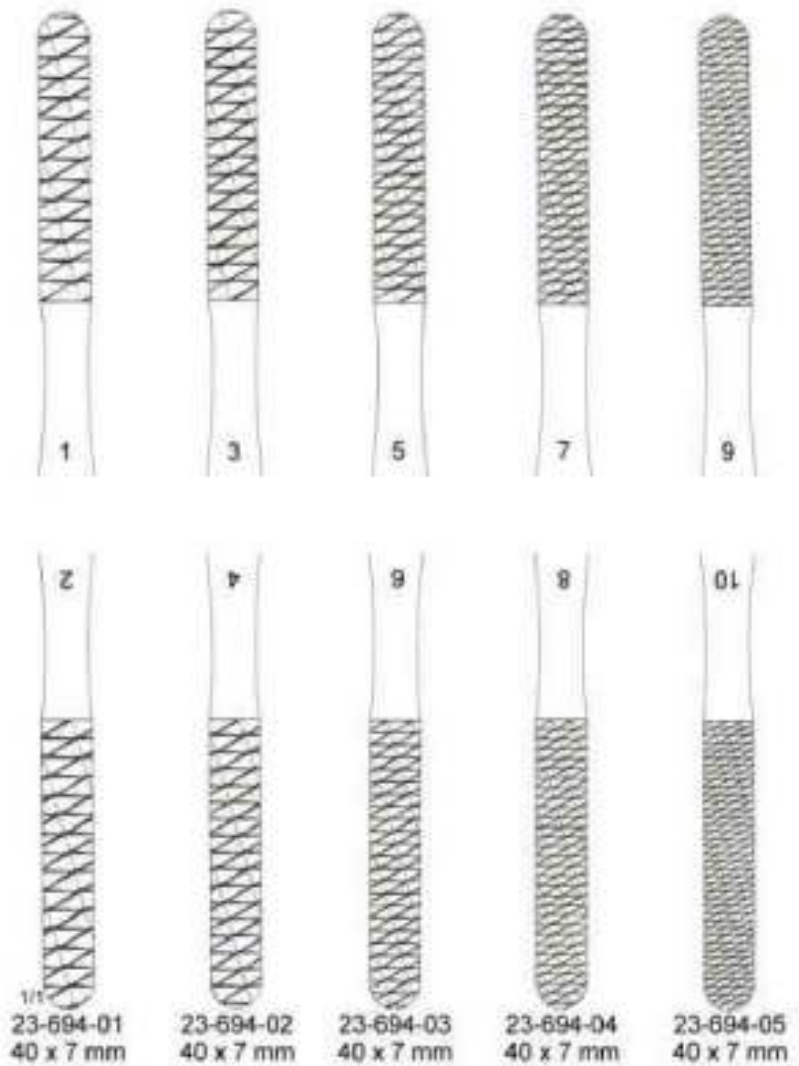



Rhinology - Rhinologie - Rinologia
Rhinoplastic Instruments etc.
Instrumente zur Nasenplastik usw.
Instrumentos para la plastica nasal etc.

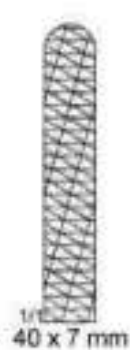

Rhinology - Rhinologie - Rinologia
Rhinoplastic Instruments etc.
Instrumente zur Nasenplastik usw.
Instrumentos para la plastica nasal etc.

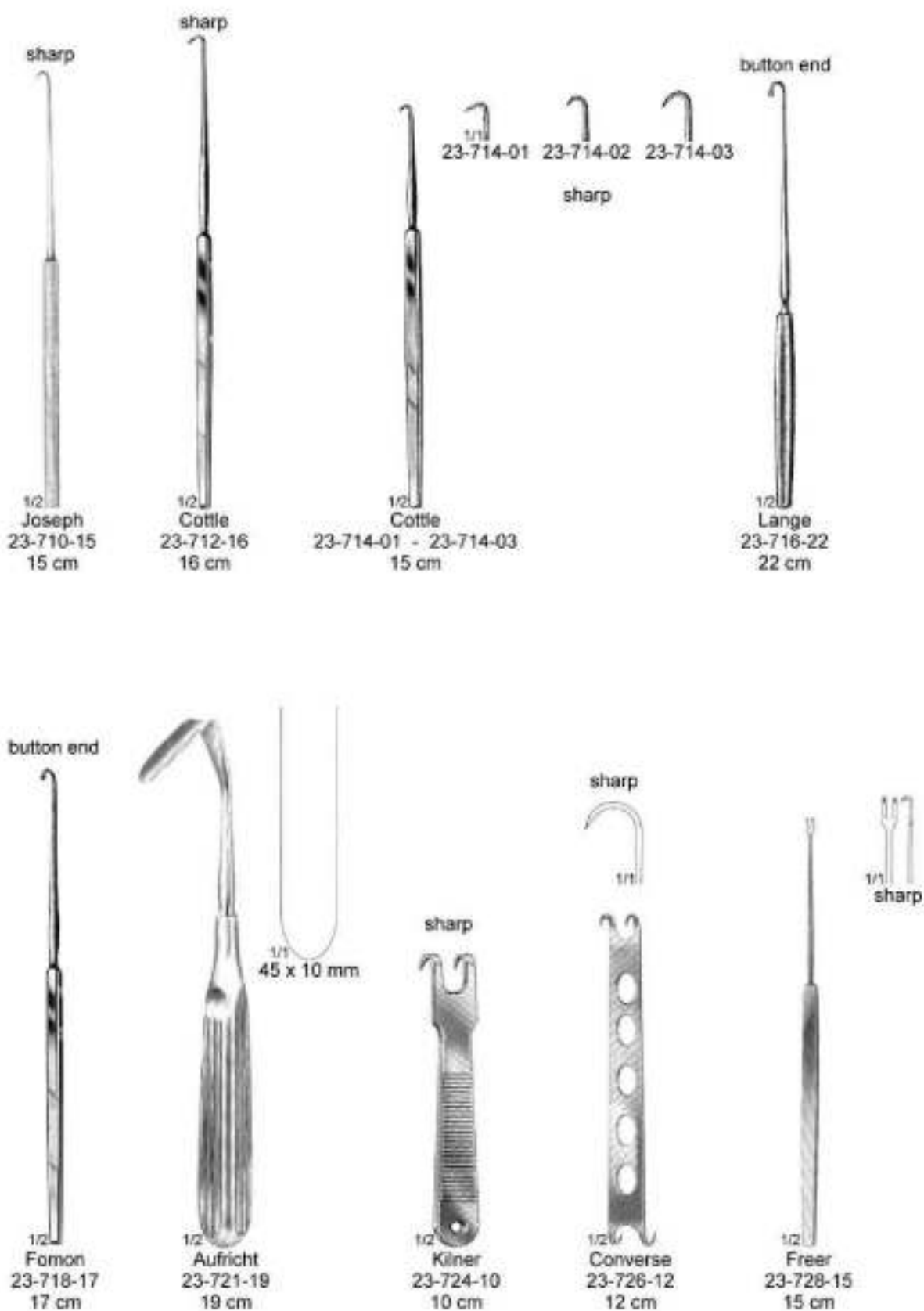



Rhinology - Rhinologie - Rinologia
Rhinoplastic Instruments etc.
Instrumente zur Nasenplastik usw.
Instrumentos para la plastica nasal etc.

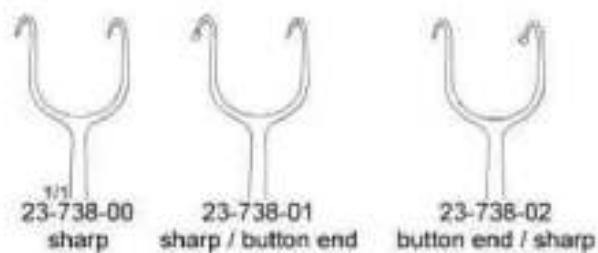
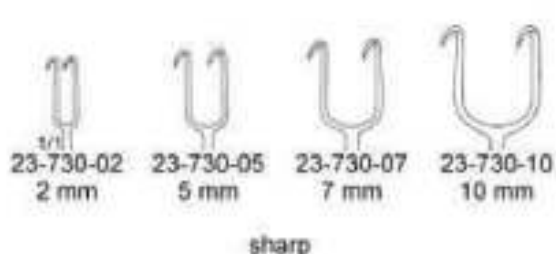



Rhinology - Rhinologie - Rinologia
Rhinoplastic Instruments etc.
Instrumente zur Nasenplastik usw.
Instrumentos para la plastica nasal etc.





Rhinology - Rhinologie - Rinologia
Rhinoplastic Instruments etc.
Instrumente zur Nasenplastik usw.
Instrumentos para la plastica nasal etc.



Rhinology - Rhinologie - Rinologia
Rhinoplastic Instruments etc.
Instrumente zur Nasenplastik usw.
Instrumentos para la plastica nasal etc.



Asch
23-801-23
23 cm



Walsham
23-806-01 - 23-806-03
23 cm



Cottle - Walsham
23-810-22
22 cm



Rhinology - Rhinologie - Rinologia
 Currettes
 Kurretten
 Curetas

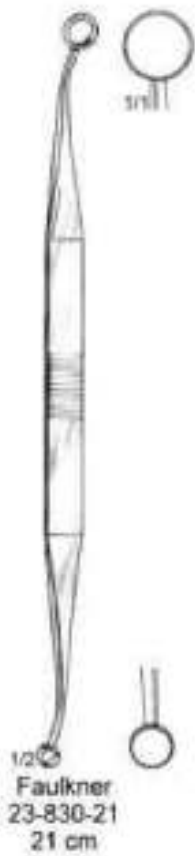

Rhinology - Rhinologie - Rinologia
Adenoid Curettes
Ringmesser
Cuchillos para vegetaciones adenoides



Fig. 1
23-860-01
23-861-01
13 mm



Fig. 2
23-860-02
23-861-02
15 mm



Fig. 3
23-860-03
23-861-03
17 mm



1/2
Fig. 4
23-860-04
23-861-04
21 mm



Fig. 5
23-860-05
23-861-05
23 mm



Fig. 6
23-860-06
23-861-06
23 mm



1/2
Beckmann
23-860-01 - 23-860-06
22 cm



1/2
Beckmann
23-861-01 - 23-861-06
22 cm

Rhinology - Rhinologie - Rinologia
Adenoid Currettes
Ringmesser
Cuchillos para vegetaciones adenoides



23-866-01
13 mm



23-866-02
15 mm



23-866-03
17 mm



1/1
23-866-04
19 mm



1/2
Barnhill
23-866-01 - 23-866-04
22 cm



23-870-01
17 mm



23-870-02
19 mm



23-870-03
21 mm



1/1
23-870-04
22 mm



1/2
St. Clair - Thompson
23-870-01 - 23-870-04
21 cm

Rhinology - Rhinologie - Rinologia
Adenoid Currettes, Adenotomes
Ringmesser, Tonsillotome
Cuchillos para vegetaciones adenoides, Adenotomos

with unperforated blade



Fig. 1
23-880-01



Fig. 2
23-880-02



Fig. 3
23-880-03

with perforated blade



Fig. 1
23-882-01



Fig. 2
23-882-02



Fig. 3
23-882-03



10
La Force
23-880-01 - 23-882-03
25 cm

Rhinology - Rhinologie - Rinologia
Wash Cannulas, Wash Catheters, Probes
Spulkanulen, Spulkatheter, Sonden
Canulas lavadores, Cateteras lavadores, Estiletos

Ø 3 mm



1/2
Eicken - Killian
23-901-30
14 cm



1/2
Siebenmann
23-905-15 Ø 1.5 mm
23-905-17 Ø 1.7 mm
23-905-20 Ø 2.0 mm
23-905-25 Ø 2.5 mm
23-905-30 Ø 3.0 mm
15 cm



1/2
Guilen
23-910-20
20 cm



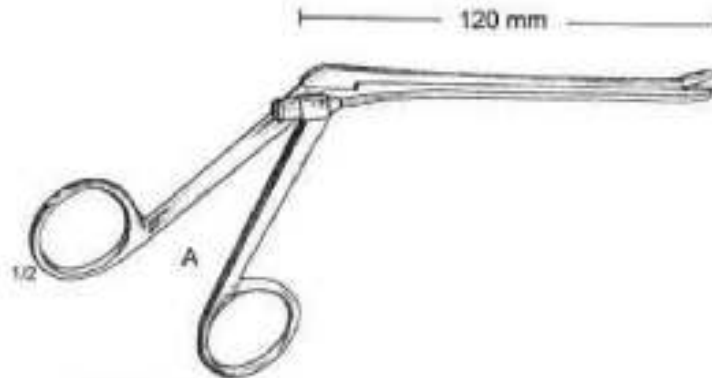

1/2
Ritter - Halle
23-915-25 Ø 2.5 mm
23-915-30 Ø 3.0 mm
23-915-40 Ø 4.0 mm
14.5 cm

Rhinology - Rhinologie - Rinologia
Sinuscopy Forceps
Sinuskopie-Zangen
Pinzas para senoscopia



Weil - Blakesley
 23-930-01 - 23-930-23

				
0°	A	23-930-01	23-930-02	23-930-03
	B	23-930-11	23-930-12	23-930-13
45°	A	23-930-06	23-930-07	23-930-08
	B	23-930-16	23-930-17	23-930-18
90°	A	23-930-21	23-930-22	23-930-23
	B	23-930-31	23-930-32	23-930-33
		2.5 mm	3.0 mm	3.5 mm

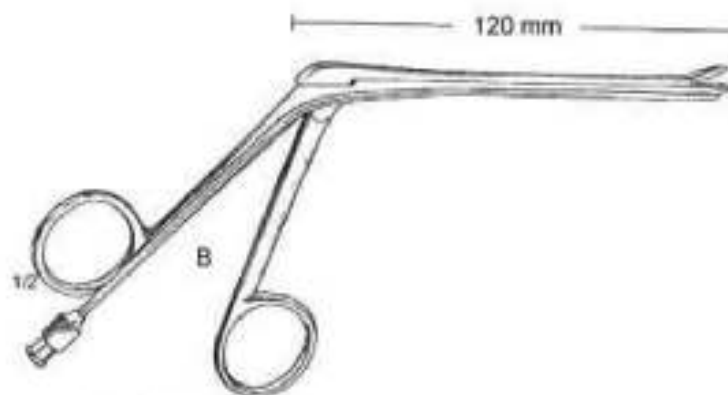

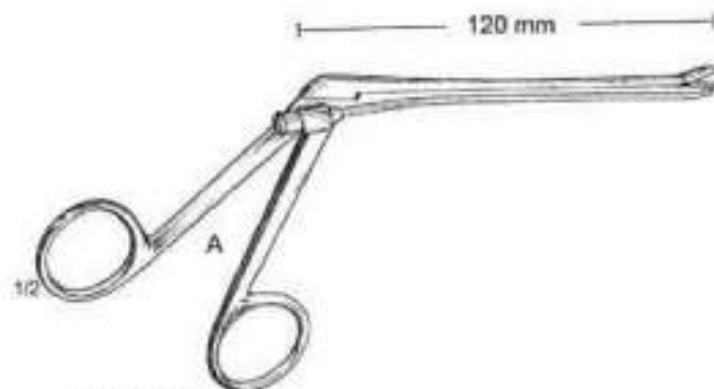

Weil - Blakesley
 23-930-11 - 23-930-33

Rhinology - Rhinologie - Rinologia
Sinuscopy Forceps
Sinuskopie-Zangen
Pinzas para senoscopia



Weil - Blakesley
 23-930-40 - 23-930-47

				
right	A	23-930-40	23-930-41	23-930-42
	B	23-930-50	23-930-51	23-930-52
left	A	23-930-45	23-930-46	23-930-47
	B	23-930-55	23-930-56	23-930-57
		2.5 mm	3.0 mm	3.5 mm

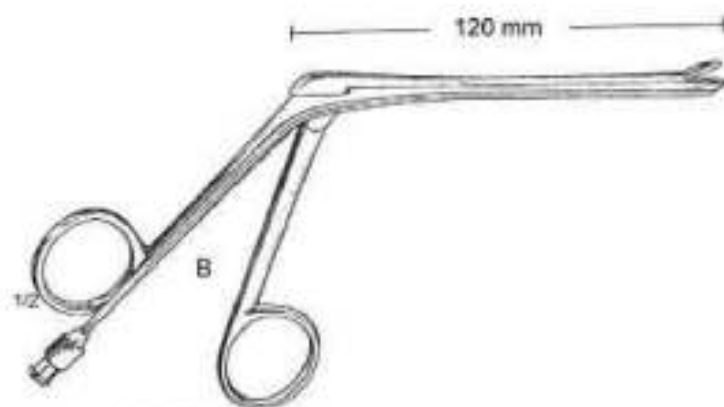

Weil - Blakesley
 23-930-50 - 23-930-57

Rhinology - Rhinologie - Rinologia
Sinuscopy Forceps
Sinuskopie-Zangen
Pinzas para senoscopia

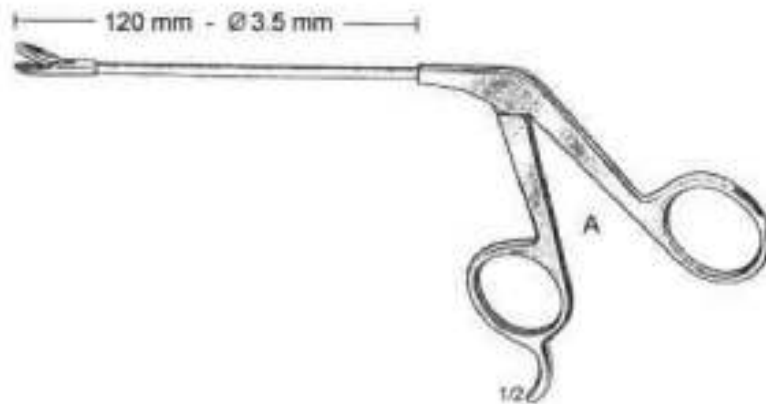

Weil - Blakesley	0°	A 23-940-01 B 23-940-11	23-940-02 23-940-12	23-940-03 23-940-13	23-940-04 23-940-14
		2.5 mm	3.0 mm	3.5 mm	4.0 mm
Weil - Blakesley	45°	A 23-940-06 B 23-940-16	23-940-07 23-940-17	23-940-08 23-940-18	23-940-09 23-940-19
		2.5 mm	3.0 mm	3.5 mm	4.0 mm
Takahashi		A 23-940-27 B 23-940-37			
		4 x 10 mm			
Struycken		A 23-940-28 B 23-940-38			
		1 x 10 mm			

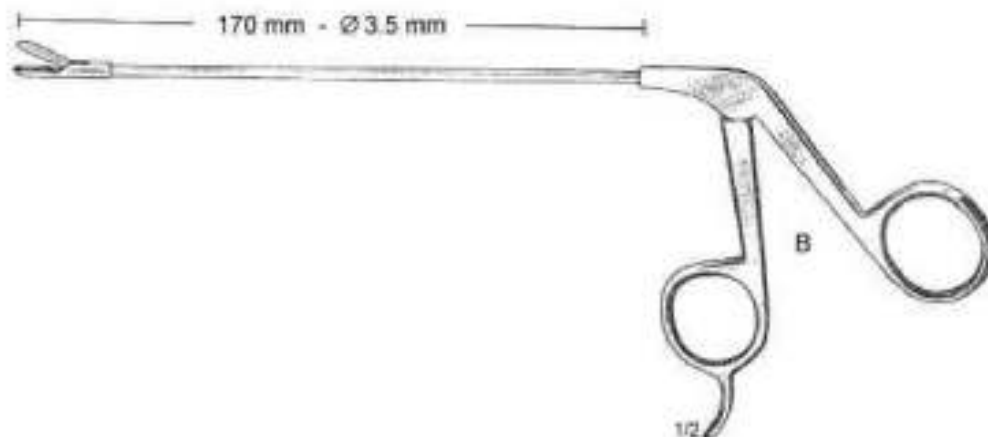



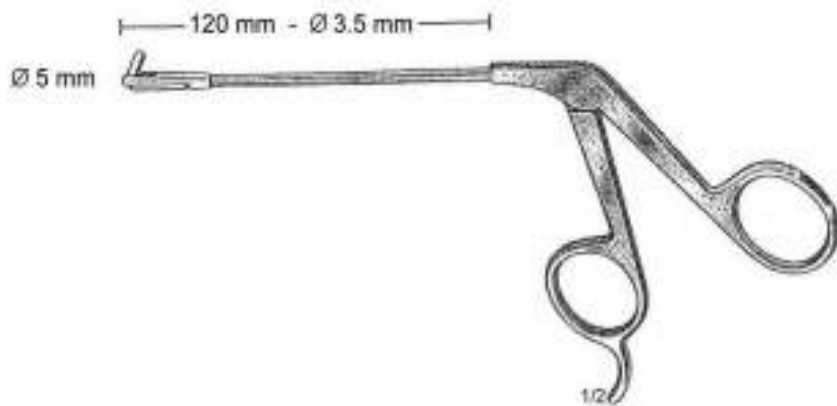

Rhinology - Rhinologie - Rinologia
 Sinuscopy Forceps
 Sinuskopie-Zangen
 Pinzas para senoscopia

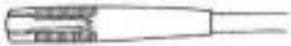

Stanzen Punches
 23-950-01 - 23-950-23

	23-950-01	23-950-02	23-950-03
	23-950-11	23-950-12	23-950-13
	23-950-21	23-950-22	23-950-23
	1.5 x 6.0 mm	2.0 x 6.0 mm	2.5 x 8.0 mm

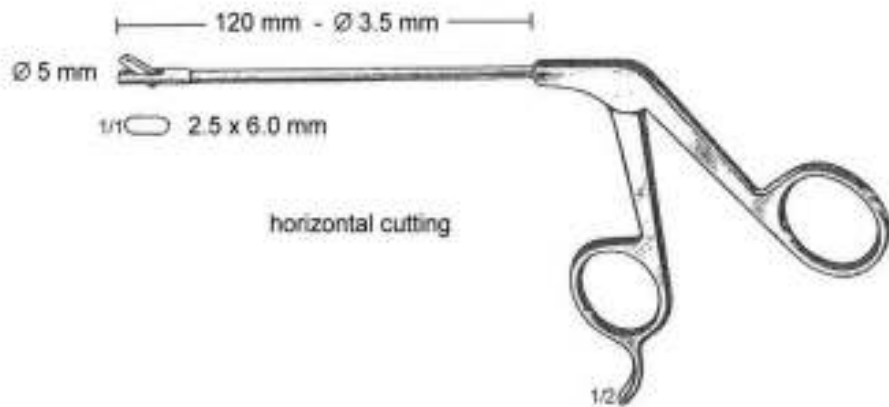

23-956-01	0°
23-956-02	30°
23-956-03	45°
23-956-04	60°
23-956-05	70°

Rhinology - Rhinologie - Rinologia
Sinuscopy Forceps
Sinuskopie-Zangen
Pinzas para senoscopia

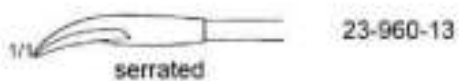
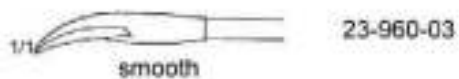
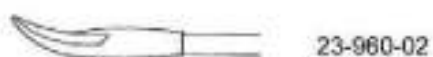

Rhinology - Rhinologie - Rinologia
Sinuscopy Forceps
Sinuskopie-Zangen
Pinzas para senoscopia

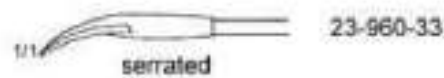
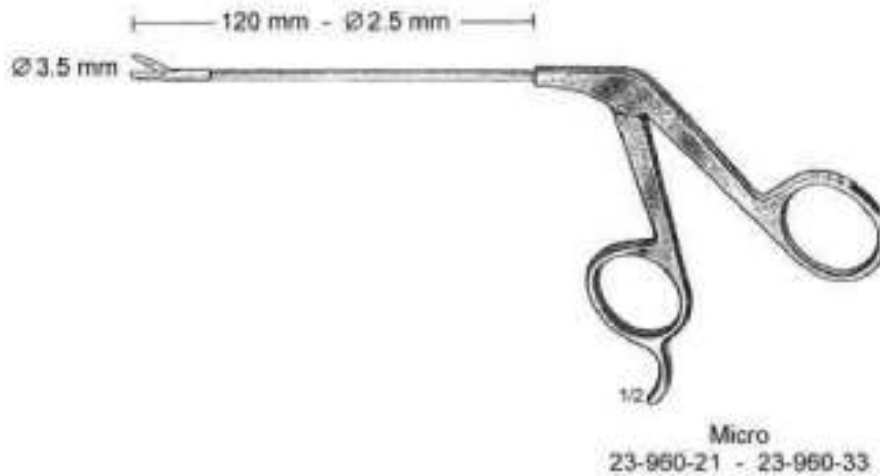
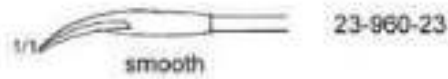

Rhinology - Rhinologie - Rinologia
Sinuscopy Forceps
Sinuskopie-Zangen
Pinzas para senoscopia

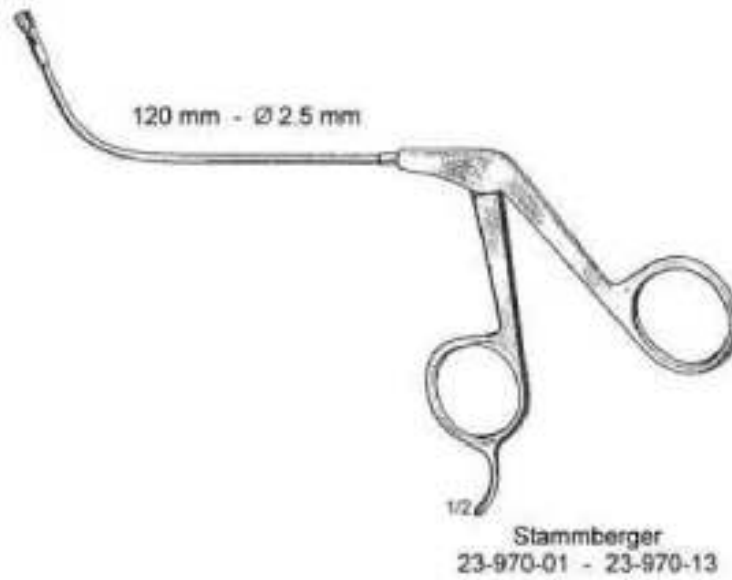

	horizontal cutting	vertical cutting
70°	23-970-01	23-970-11
90°	23-970-02	23-970-12
110°	23-970-03	23-970-13

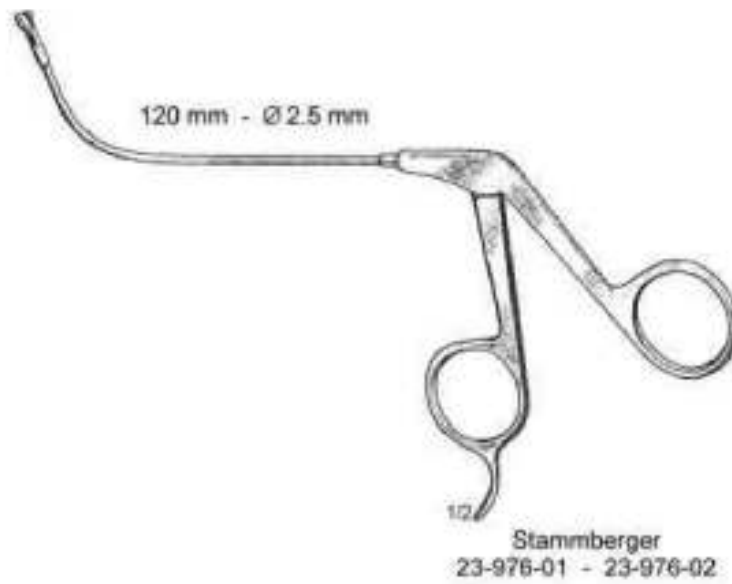

	horizontal cutting	vertical cutting
65°	23-976-01	23-976-02



Oral, Maxillo-Facial Surgery - Mund, Kiefer-und Gesichtschirurgie
Mouth Gags
Mundsperrer
Abre - bocas



1/2
Heister
24-100-13
13 cm



1/2
Molt
24-141-11
11 cm



1/2
Molt
24-141-14
14 cm



1/2
Denhart
24-147-12
12 cm



Roser - König
24-149-16 16 cm
24-149-20 20 cm



Oral, maxillo-Facial Surgery - Cirugia oral y maxillo-facial
Mouth Gags
Mundsprerre
Abre - bocas



24-174-10
Gag only

1/2
Kilner - Doughty
24-174-00

complete



1/2
Fig. 1
24-174-01
65 x 28 mm



Fig. 2
24-174-02
75 x 32 mm



Fig. 3
24-174-03
80 x 37 mm



24-174-04



Oral, Maxillo-Facial Surgery - Mund, Kiefer-und Gesichtschirurgie
Mouth Gags
Mundsperrer
Abre - bocas

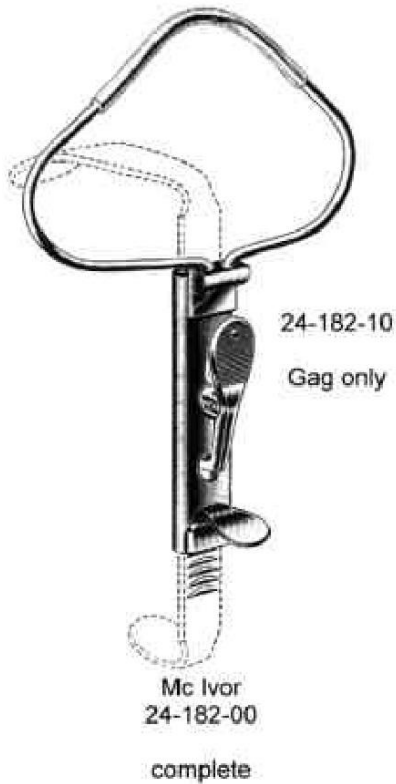
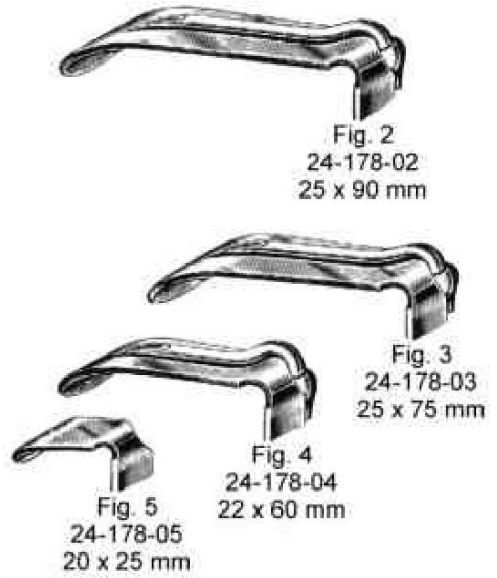
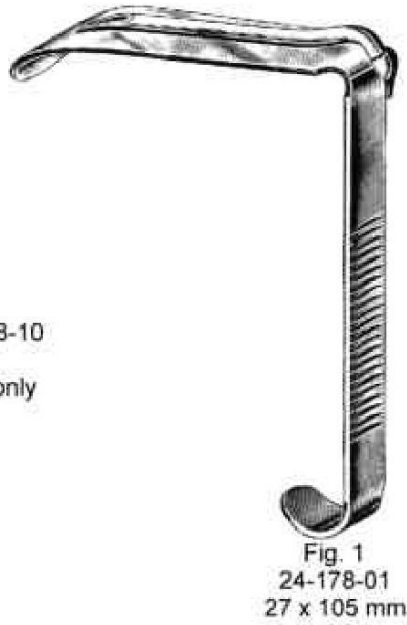
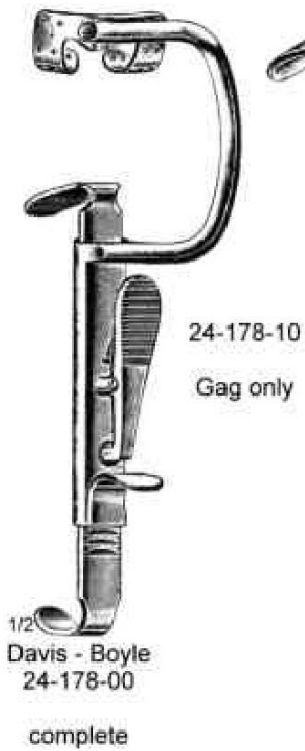



Oral, maxillo-Facial Surgery - Cirugia oral y maxillo-facial
Mouth Gags
Mundsperrre
Abre - bocas

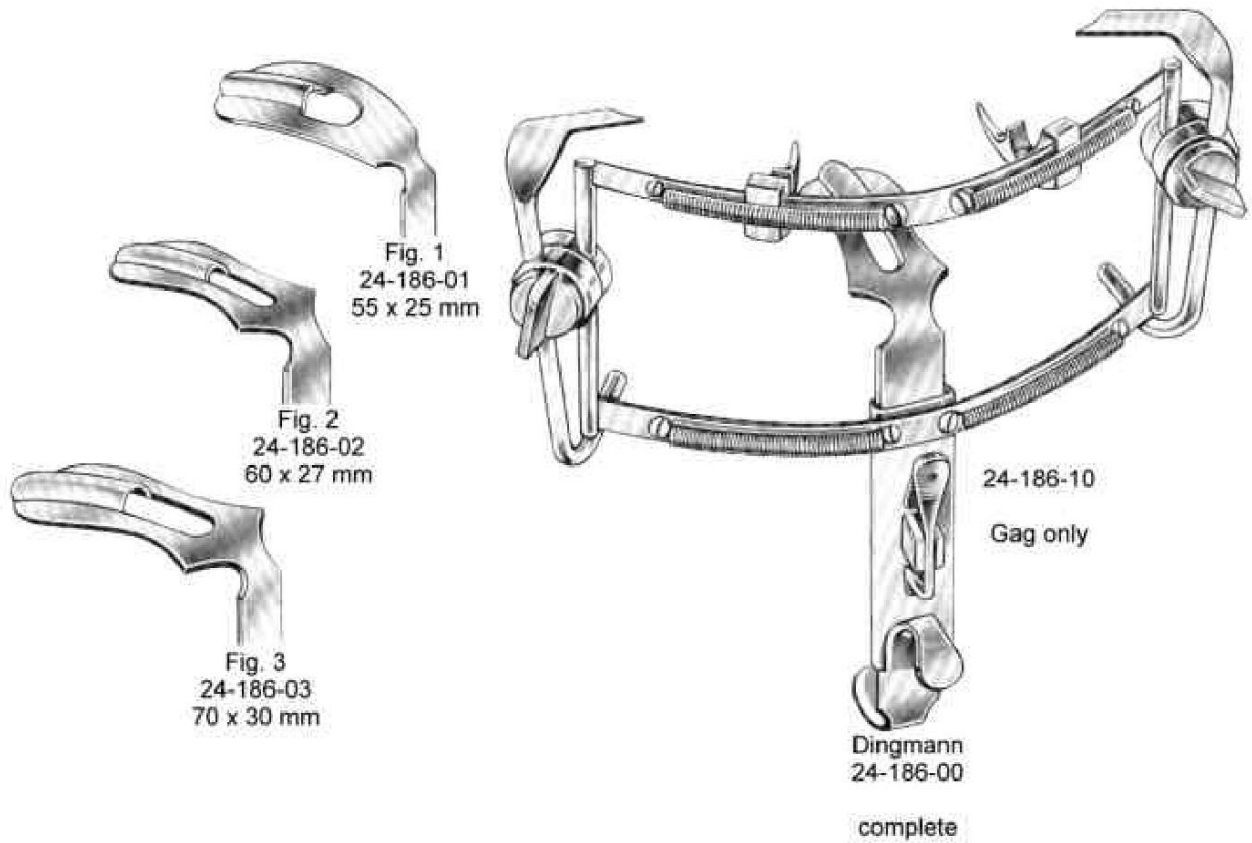

Modell Wurzburg

24-190-01	Fig. 1	66 x 28 mm
24-190-02	Fig. 2	75 x 32 mm
24-190-03	Fig. 3	83 x 34 mm
24-190-04	Fig. 4	93 x 37 mm
24-190-05	Fig. 5	100 x 38 mm

chest support for mouth gag

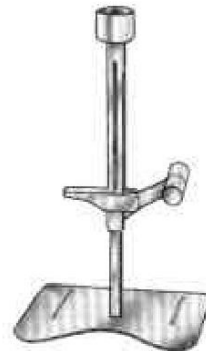

Negus
24-196-00

Oral, Maxillo-Facial Surgery - Mund, Kiefer-und Gesichtschirurgie
Mouth Gags
Mundsperrer
Abre - bocas



Jennings
 24-250-09
 24-250-11
 24-250-13
 24-250-15



Seemann - Seiffert
 24-254-09
 24-254-11
 24-254-13
 24-254-15



Whitehead
 24-260-09
 24-260-11
 24-260-13
 24-260-15

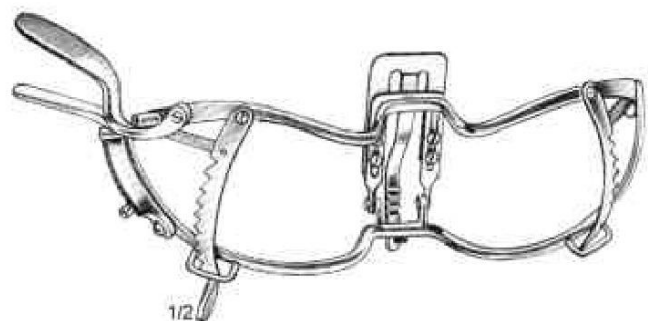

Whitehead
 24-264-09
 24-264-11
 24-264-13
 24-264-15



Oral, maxillo-Facial Surgery - Cirugia oral y maxillo-facial
Cheek - Lip Retractor
Selbsthaltender Lippensperrer
Especulo para la boca segun



1/2
Oringer
24-290-00 - 24-290-13

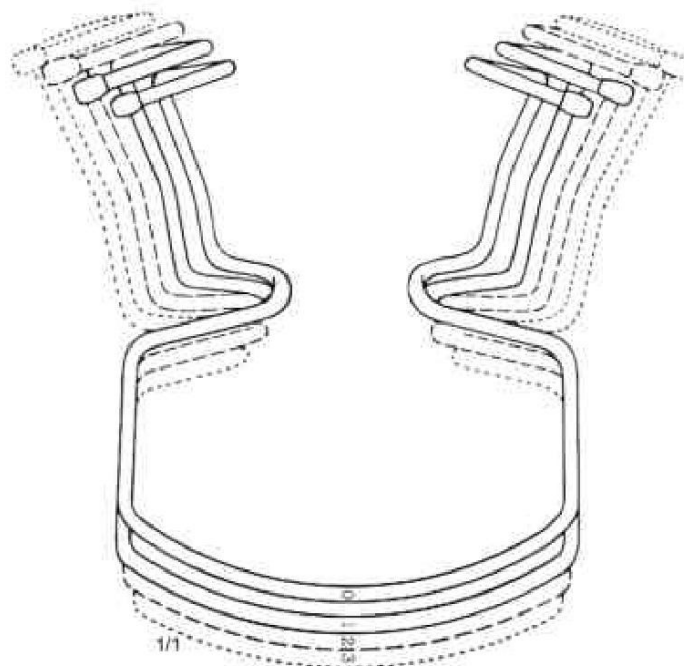

- 24-290-00 Fig. 0 9.5 cm
- 24-290-01 Fig. 1 10.0 cm
- 24-290-02 Fig. 2 10.5 cm
- 24-290-03 Fig. 3 11.0 cm

24-290-13 Set (Fig. 1 - 3)

Oral, Maxillo-Facial Surgery - Mund, Kiefer-und Gesichtschirurgie
Cheek and Lip Retractors, Tongue Depressors
Wangen-und Lippenhalter, Zungendrucker
Separadores para labios y mejillas, Abaja - lenguas



1/2
Simplex
24-301-11
11 cm



Stemberg
24-305-12 12 cm
24-305-14 14 cm
24-305-16 16 cm



1/2
Mod. Martin
24-309-19
19 cm



1/2
Mod. Martin
24-311-21
21 cm



1/2
Bishop
24-315-13
13 cm

Oral, maxillo-Facial Surgery - Cirugia oral y maxillo-facial
Cheek and Lip Retractors, Tongue Depressors
Wangen-und Lippenhalter, Zungendrucker
Separadores para labios y mejillas, Abaja - lenguas

72 x 23 mm



1/2
Hartmann
24-321-15
15 cm

88 x 25 mm

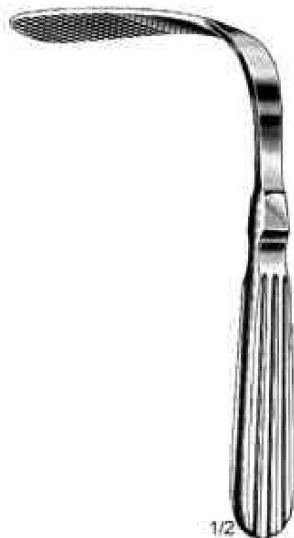

1/2
Tobold
24-325-14
14.5 cm

85 x 24 mm

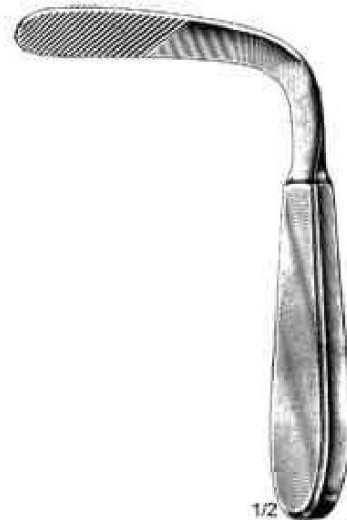

1/2
Tobold
24-329-14
14.5 cm



1/2
Andrew
24-333-11
11 cm



1/2
Wieder
24-337-01 - 24-337-02



1/2
24-337-01
14 cm



24-337-02
15 cm

Oral, Maxillo-Facial Surgery - Mund, Kiefer-und Gesichtschirurgie
Tongue Depressors
Zungendrucker
Abaja - lenguas



1/2
Montz - Schmidt
 24-361-19
 19 cm



1/2
Standard
 24-365-14
 14.5 cm



1/2
Univ. Minnesota
 24-369-14
 14 cm



1/2
Kroenig
 24-371-15
 15 cm



1/2
Mayo
 24-375-17
 17 cm

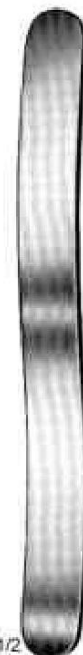

18 mm
 1/2
24-379-18
 18 cm



Oral, maxillo-Facial Surgery - Cirugia oral y maxillo-facial
Tongue Depressors
Zungendrucker
Abaja - lenguas



24-381-16
16 cm



24-385-15
15 cm



Haas
24-389-16
16 cm

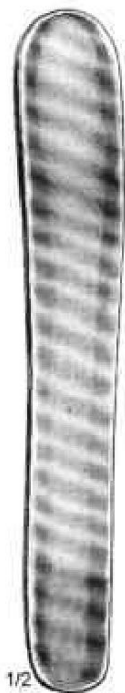

Buchwald
24-391-17
17 cm



Bruenings
24-395-19
19 cm



Frenzel
24-399-16
16.5 cm



Oral, Maxillo-Facial Surgery - Mund, Kiefer-und Gesichtschirurgie
Minnesota Retractor
Minnesota Wangenhalter
Separador Minnesota

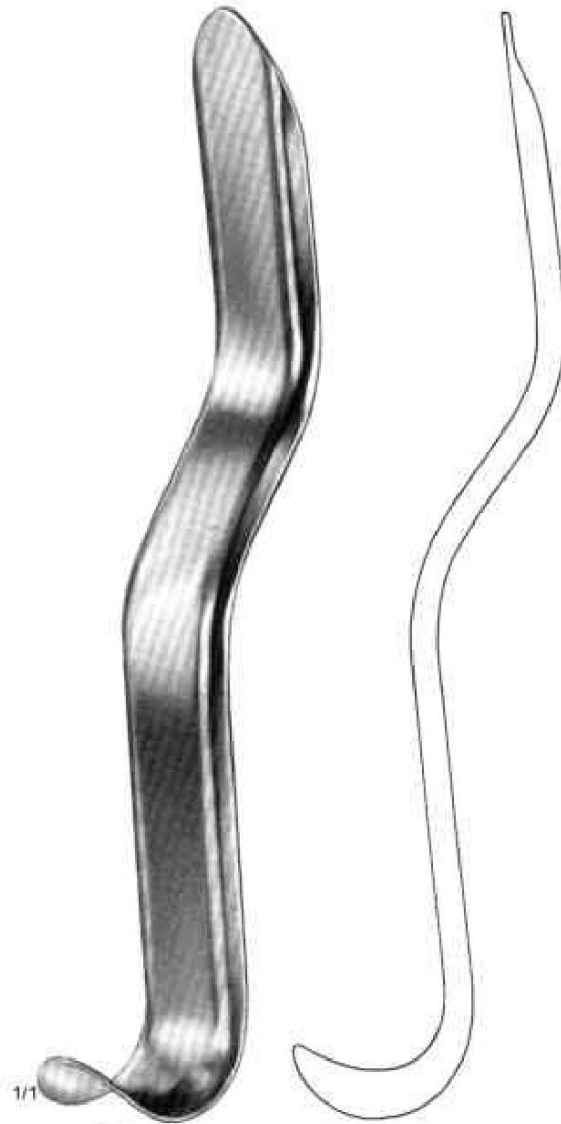

1/1

Cawood
24-425-15
15.5 cm



Oral, maxillo-Facial Surgery - Cirugia oral y maxillo-facial
Tongue Holding Forceps
Zungenzangen
Pinzas tira - lenguas





Oral, Maxillo-Facial Surgery - Mund, Kiefer-und Gesichtschirurgie
Oral Tissue Retractors
Weichteilhaken
Separadores

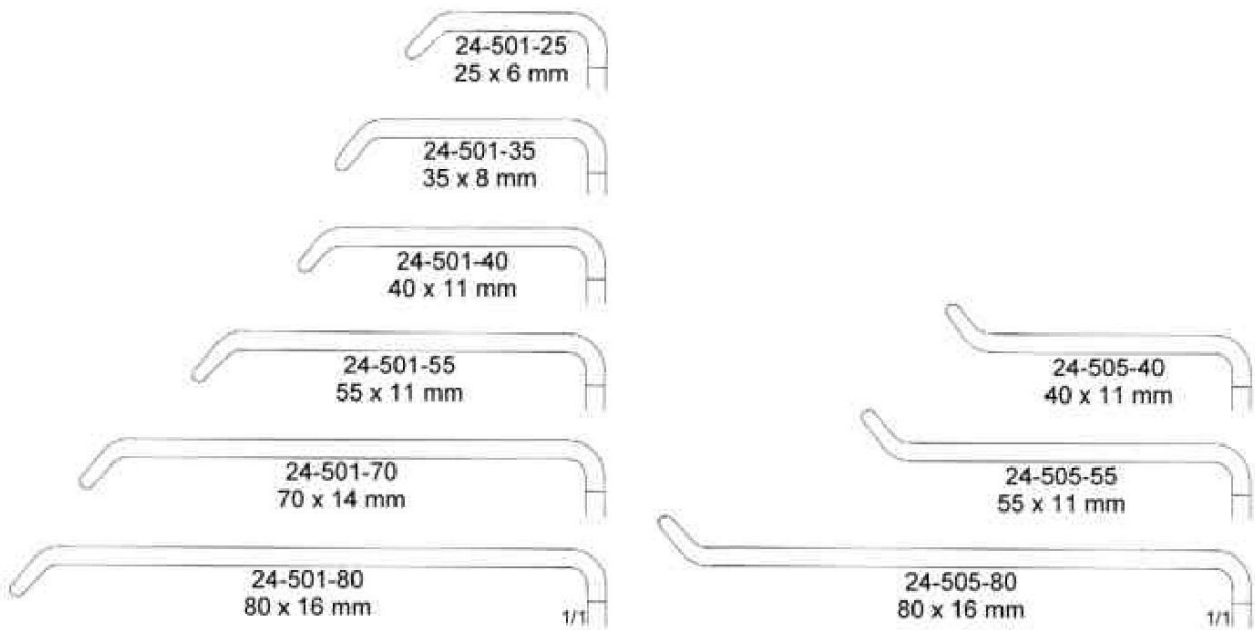

1/2
Obwegeser
24-501-25 - 24-501-80
21.5 cm



1/2
Obwegeser
24-505-40 - 24-505-80
22 cm



Oral, maxillo-Facial Surgery - Cirugia oral y maxillo-facial
Ramus Retractors
Ramushaken
Separadores de rama

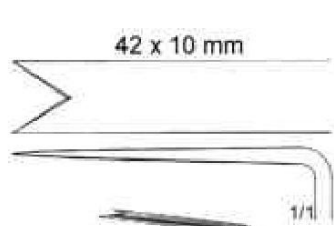

1/2
Obwegeser
24-521-22
22 cm

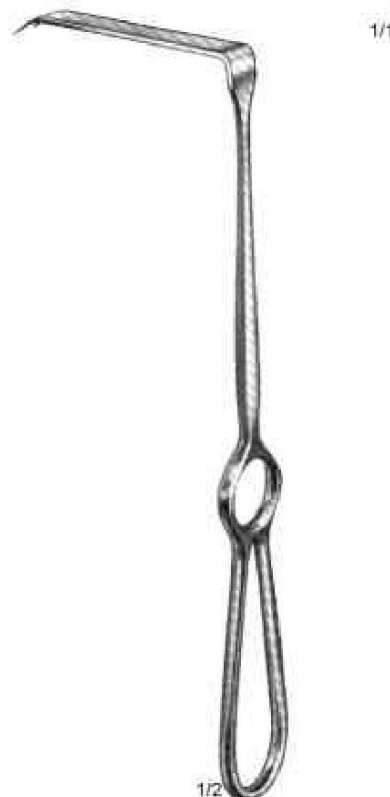
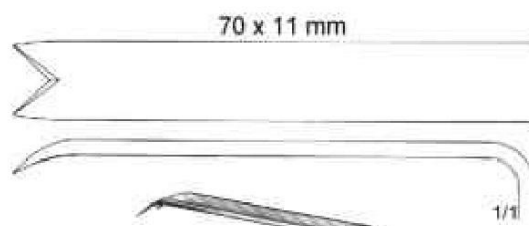

1/2
Obwegeser
24-525-22
22 cm



Oral, Maxillo-Facial Surgery - Mund, Kiefer-und Gesichtschirurgie
Chin retractor and Channelled retractor
Kinnhalter und Progeniehaken
Gancho para el menton y separadores para progenisimo



1/2
Obwegeser
24-541-16
16 cm



1/2
Obwegeser
24-545-08 8 mm
24-545-10 10 mm
16 cm



Oral, maxillo-Facial Surgery - Cirugia oral y maxillo-facial
Periosteal Elevators
Raspatorien
Periostotomos



1/2
Obwegeser
24-560-06 - 24-560-11
17.5 cm

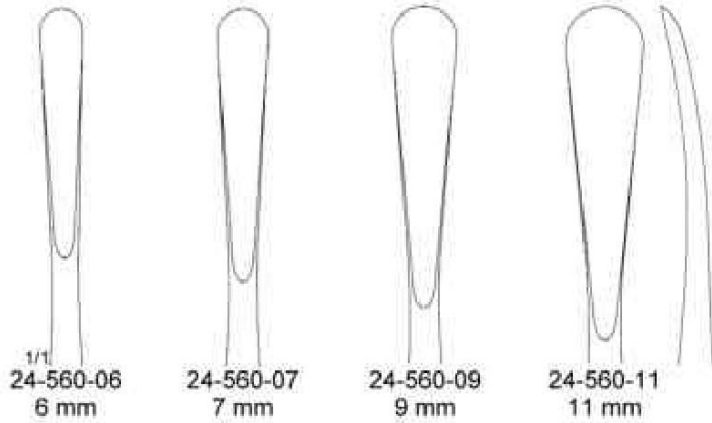

1/2
Obwegeser
24-565-05 - 24-565-09
20 cm

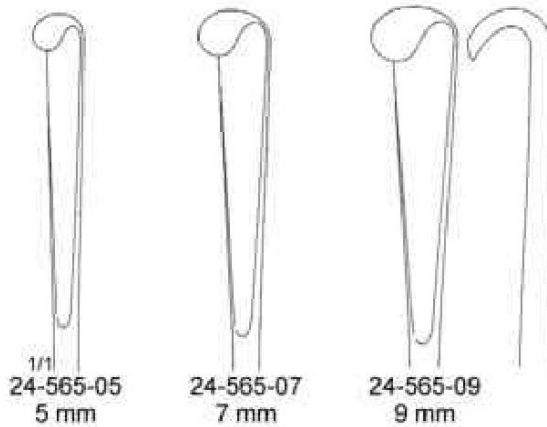



Oral, Maxillo-Facial Surgery - Mund, Kiefer-und Gesichtschirurgie
Periosteal Elevators, Osteotomes
Raspatorien, Osteotome
Periostotomos, Osteotomos

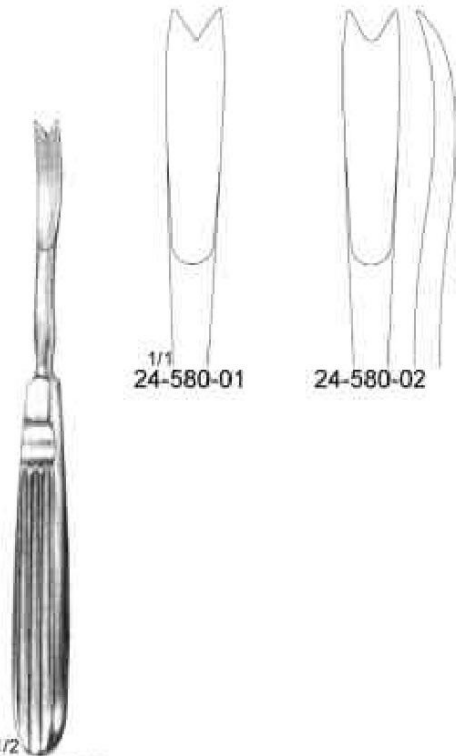

1/1
24-580-01

24-580-02



1/2
Obwegeser
24-586-21
21 cm

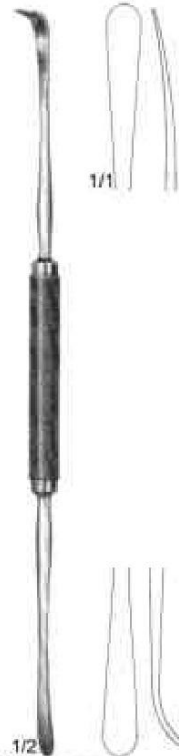

1/2
Obwegeser
24-588-21
21 cm

1/2
Obwegeser
24-580-01 - 24-580-02
17.5 cm

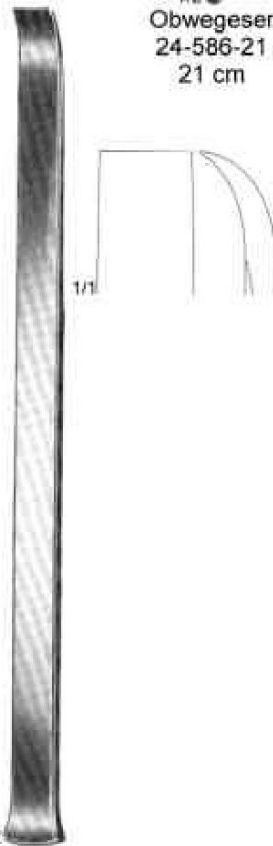

1/2
Obwegeser
24-606-23
23.5 cm

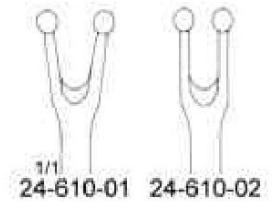

1/2
Obwegeser
24-610-01 - 24-610-02
18.5 cm



24-600-02
2.5 mm



24-600-04
4 mm



1/1
24-600-06
6.5 mm



1/2
Obwegeser
24-600-02 - 24-600-06
15 cm



Oral, maxillo-Facial Surgery - Cirugia oral y maxillo-facial
Awls
Ahlen
Leznas

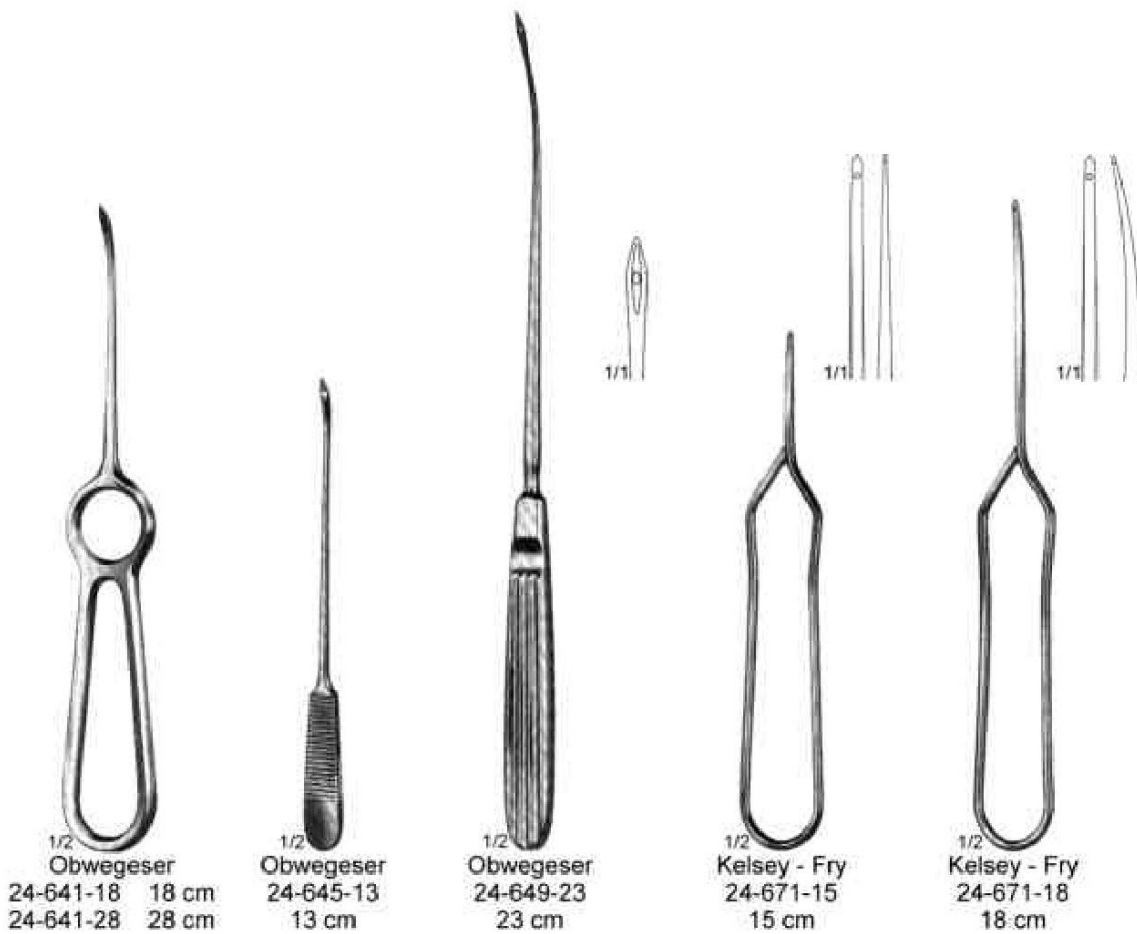



Oral, Maxillo-Facial Surgery - Mund, Kiefer-und Gesichtschirurgie
Disimpaction Forceps
Repositionszangen
Pinzas para cordales impactados

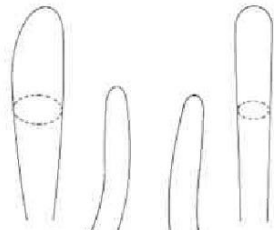

1/1

24-750-01
24-754-01

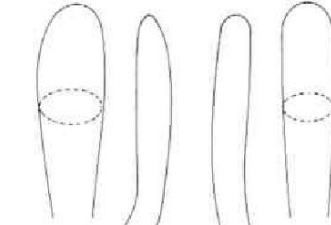

1/1

24-750-02
24-754-02

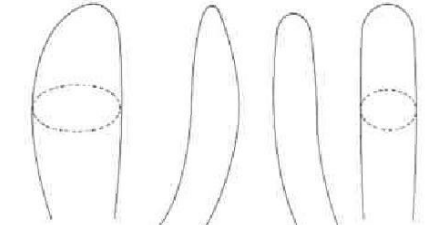

1/1

24-750-03
24-754-03

left



Rowe
24-750-01 - 24-750-03

right



Rowe
24-754-01 - 24-754-03

Palate, Tonsils - Gaumen, Tonsillen - Paladar, Amigdalas
Cleft Plate Needles, Tonsil Needles
Nadeln zur Gaumennaht, Tonsillennadeln
Agujas para suturas del paladar, Agujas para suturas del amidgales

curved to left
for the right hand

curved to right
for the left hand



Hurd
25-103-21 - 25-107-21
21 cm

curved to left
for the right hand

curved to right
for the left hand



Dupuy Weiss
25-113-22 - 25-117-22
22 cm

Palate, Tonsils - Gaumen, Tonsillen - Paladar, Amígdalas
Tonsil Knives, Ligature Carrier
Tonsillennmesser, Roderbinder
Bisturies para amígdalas, Portaligaduras



1/2
Roder
 25-131-26
 26.5 cm



1/2
Abraham
 25-151-19
 19 cm



1/2
Canfield
 25-153-21
 21 cm



1/2
Douglas
 25-157-21
 21 cm



1/2
Fisher
 25-159-22
 22.5 cm

Palate, Tonsils - Gaumen, Tonsillen - Paladar, Amigdalas
 Tonsil Knives, Dissectors, Enucleator, Retractor
 Tonsillenmesser, Dissektoren, Enucleator, Retraktor
 Bisturies, Disecadores, Enucleador, Separador

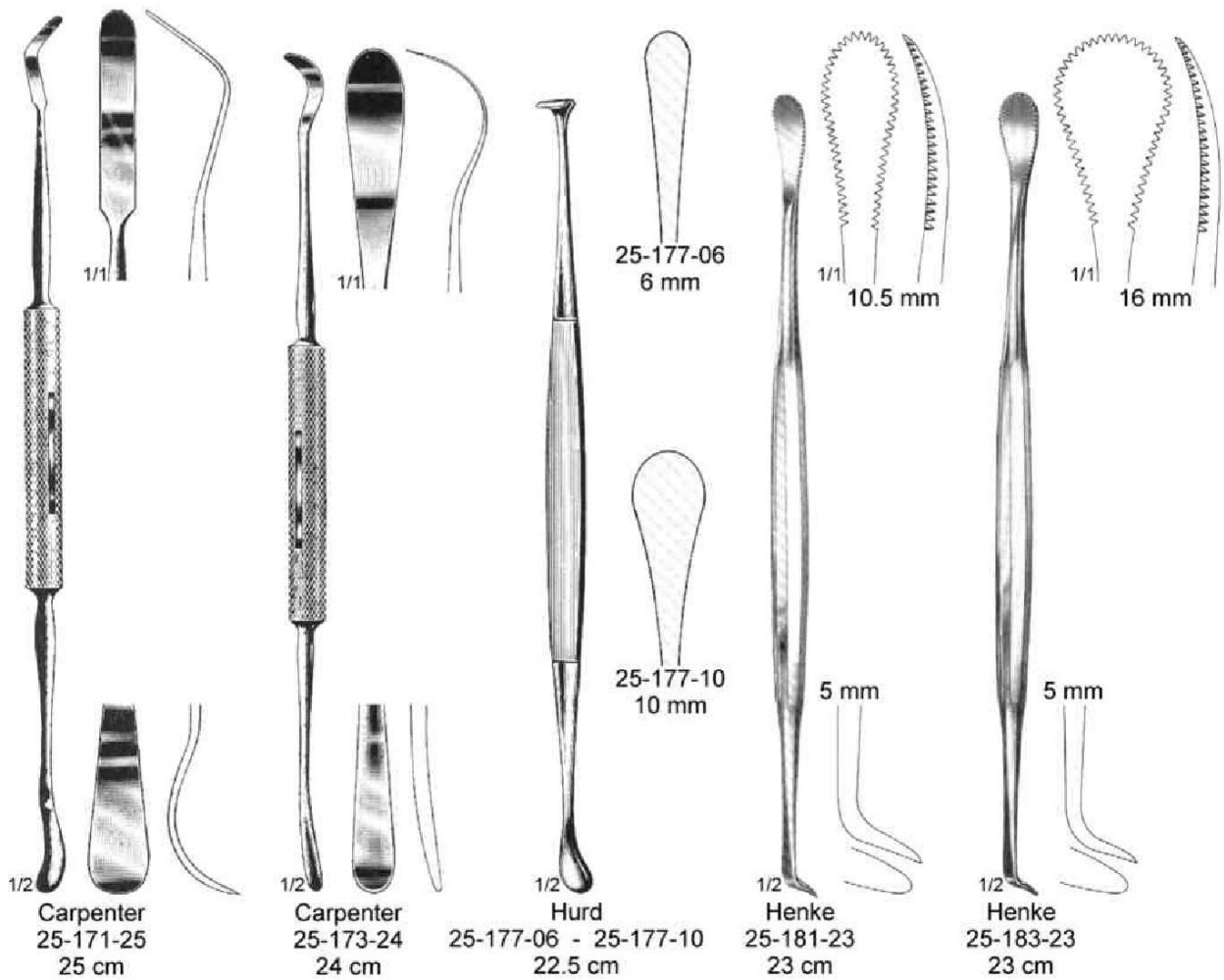

Palate, Tonsils - Gaumen, Tonsillen - Paladar, Amigdalas
Packers, Retractors, Forceps
Tamponstopfer, Haken, Pinzetten
Taponeador, Separador, Pinzas

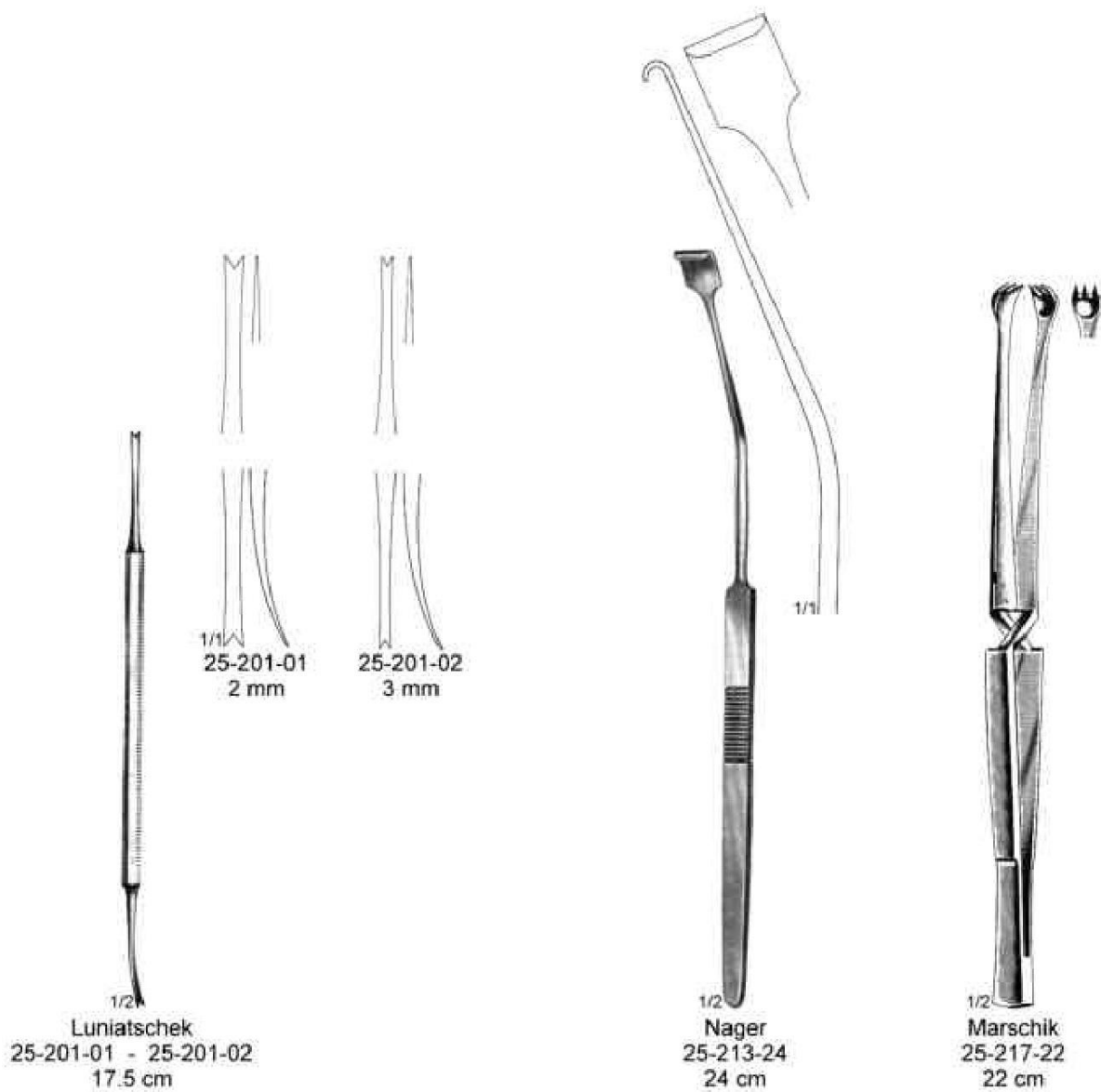



Palate, Tonsils - Gaumen, Tonsillen - Paladar, Amigdalas
Dissectors, Retractors
Dissektoren, Haken
Disecadores, Separadores

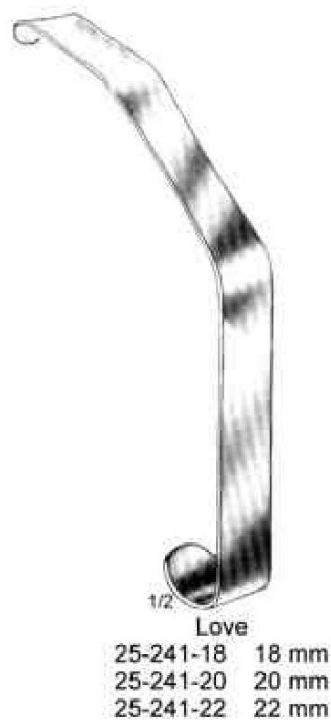
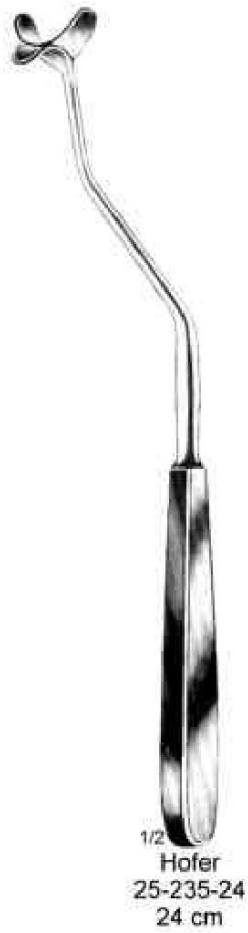

Palate, Tonsils - Gaumen, Tonsillen - Paladar, Amigdalas
Tonsil Seizing Forceps
Tinsillenzangen
Pinzas para coger las amigdalas

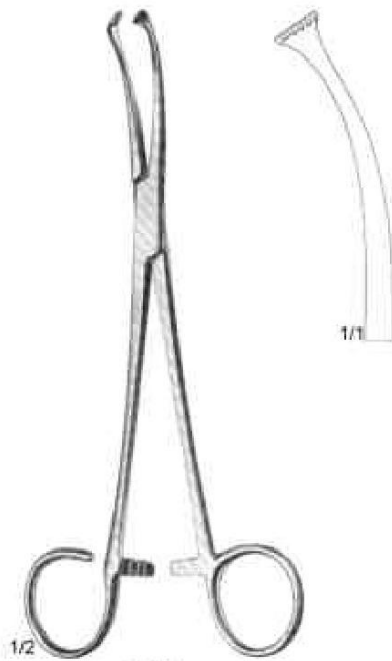

White
 25-281-18
 18 cm

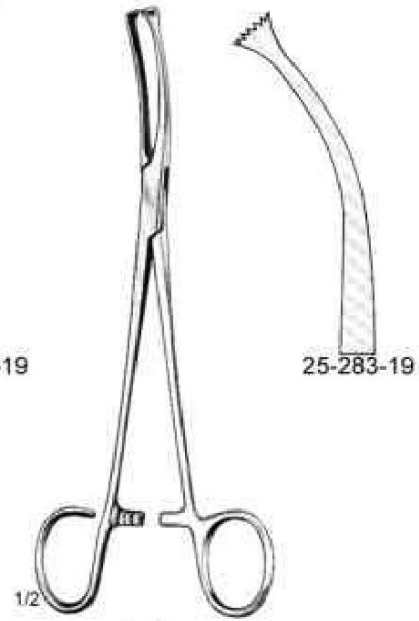
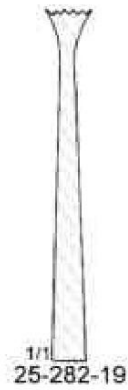

Colver
 25-282-19 - 25-283-19
 19 cm



Blohmke
 25-285-20
 20 cm
 1:2 Teeth



Museux
 25-288-20
 20 cm



Palate, Tonsils - Gaumen, Tonsillen - Paladar, Amígdalas
Tonsil Snares
Tonsillenschnurer
Cierra - nudos para amígdalas

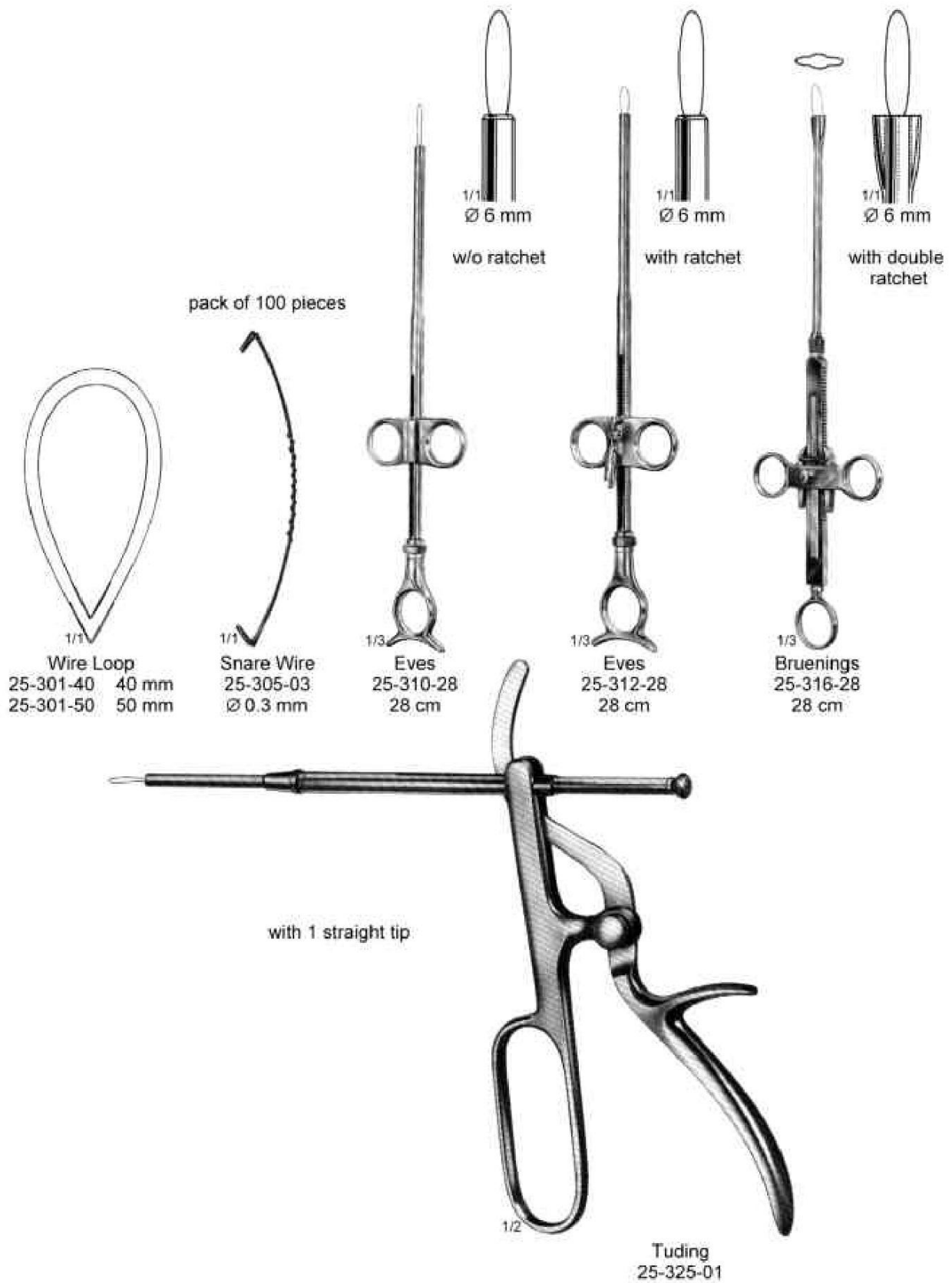



Palate, Tonsils - Gaumen, Tonsillen - Paladar, Amigdalas
Tonsillectomes
Tonsillotome
Amigdalotomos

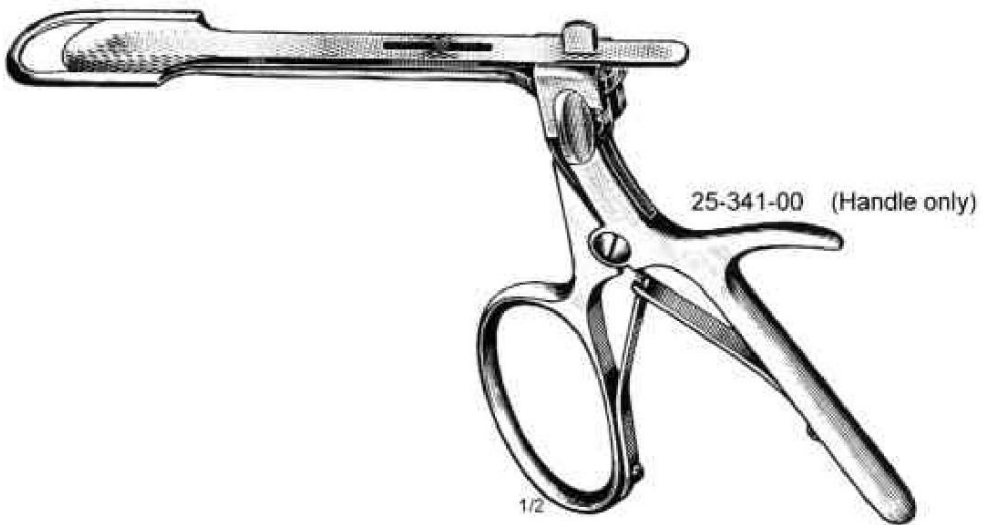
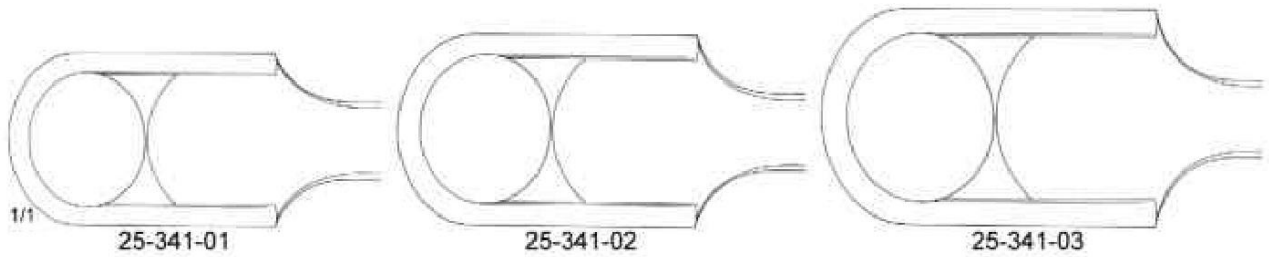

Sluder - Ballenger
25-340-03

complete

**Broncho - Laryngo - Oesophagoskopie
Tonsil Punch Forceps, Tonsil Hemostats
Tonsillenzangen, Tonsillenkompessorien
Pinzas cortantes y Compresores para amigdalas**

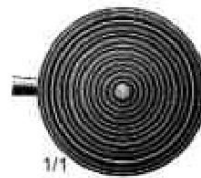
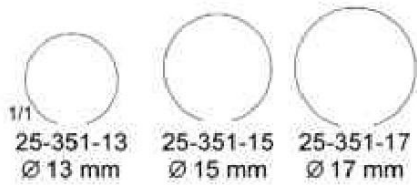

Hartmann
25-351-13 - 25-351-17

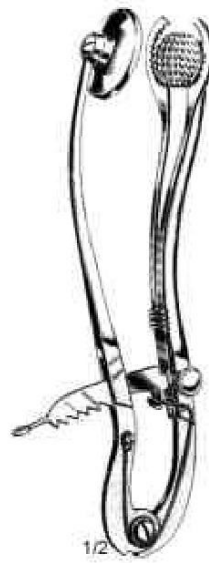

Corwin
25-361-14
14 cm

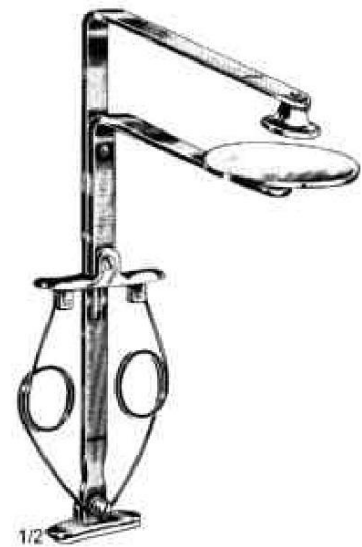

Vetter - Ulrich
25-365-15

Broncho - Laryngo - Oesophagoskopie
Broncho-Esophagoscopy Forceps
Broncho-Oesophagoskopiezangen
Pinzas para bronco-esofagoscopia

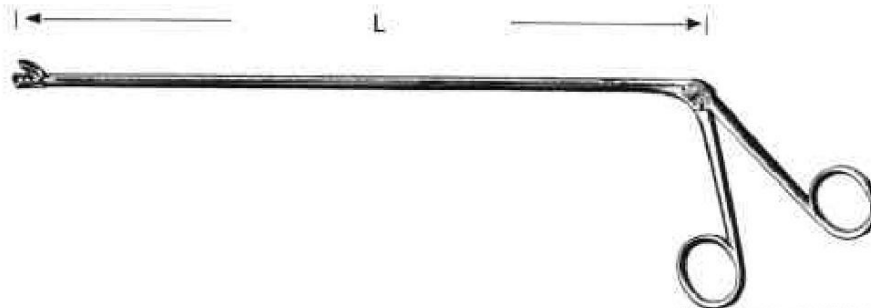

Chevalier - Jackson
 25-500-30 - 25-520-60



L = 30 cm 25-500-30
 L = 40 cm 25-500-40
 L = 50 cm 25-500-50
 L = 60 cm 25-500-60



25-502-30
 25-502-40
 25-502-50
 25-502-60



25-504-30
 25-504-40
 25-504-50
 25-504-60



25-506-30
 25-506-40
 25-506-50
 25-506-60



L = 30 cm 25-508-30
 L = 40 cm 25-508-40
 L = 50 cm 25-508-50
 L = 60 cm 25-508-60



25-510-30
 25-510-40
 25-510-50
 25-510-60



25-512-30
 25-512-40
 25-512-50
 25-512-60



25-514-30
 25-514-40
 25-514-50
 25-514-60



L = 30 cm 25-516-30
 L = 40 cm 25-516-40
 L = 50 cm 25-516-50
 L = 60 cm 25-516-60



25-518-30
 25-518-40
 25-518-50
 25-518-60



25-520-30
 25-520-40
 25-520-50
 25-520-60

Broncho - Laryngo - Oesophagoskopie
Universal Handles and Interchangeable Tubes
Universalgriffe und veränderungsroher
Mangos universales y Tubos de extension



1/2

Huber
25-531-01



1/2

Bruenings
25-533-01



1/2

25-534-20 20 cm
 25-534-30 30 cm
 25-534-40 40 cm



1/2

Bruenings
25-537-20
20 cm

Broncho - Laryngo - Oesophagoskopie
Cutting and Grasping Forceps Tips
Auswechselbare Zangenaufsätze
Pinzas intercambiables

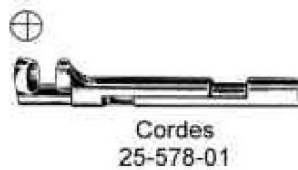
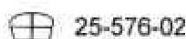
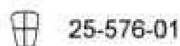
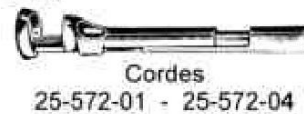
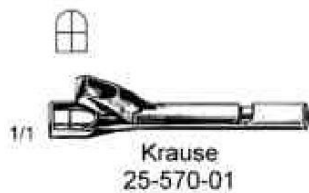
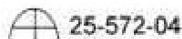
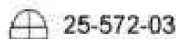
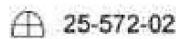
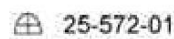
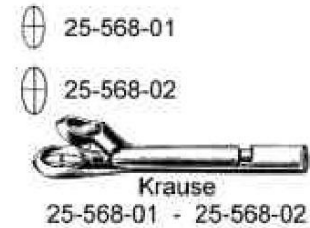
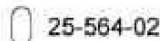
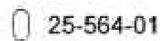
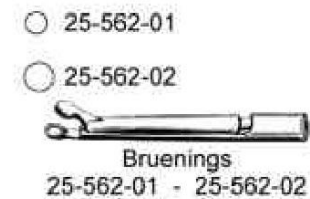





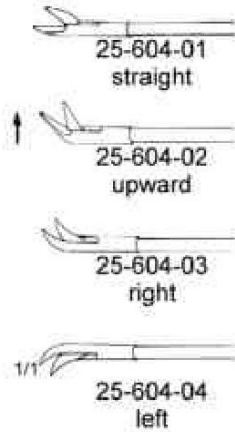
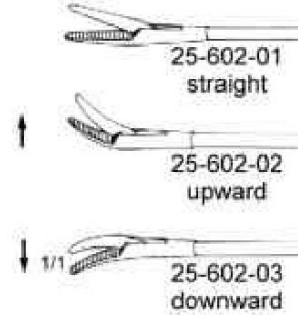
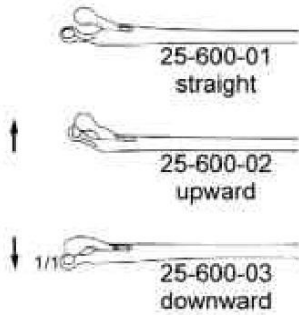
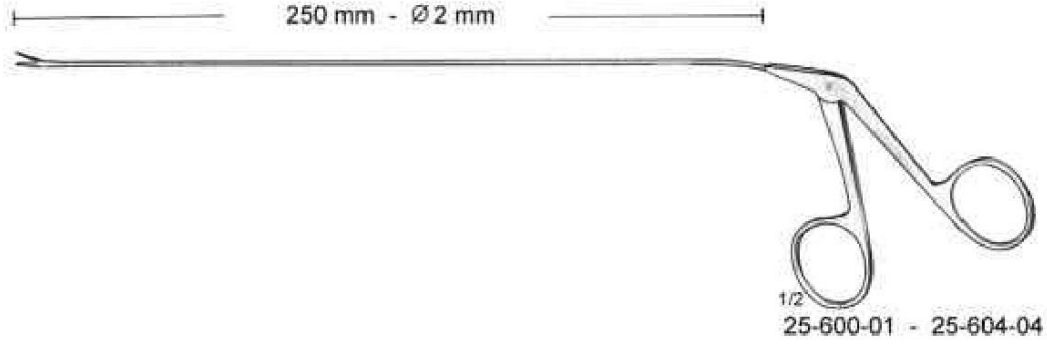

Broncho - Laryngo - Oesophagoskopie
Endolaryngeal Micro - Surgery
Endolaryneale Mikrochirurgie
Microcirurgia Endolaríngea



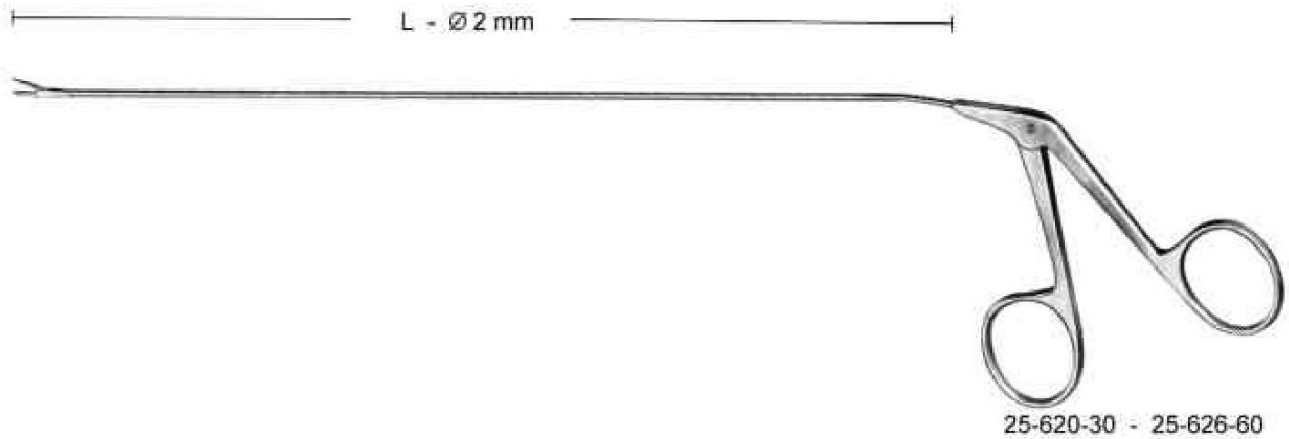





**Broncho - Laryngo - Oesophagoskopie
 Forceps for Laryngo - Bronchoscopy
 Zangen zur Laryngo - Bronchoskopie
 Pinzas para Laryngo - Broncoscopia**



				
L = 30 cm	25-620-30	25-622-30	25-624-30	25-626-30
L = 35 cm	25-620-35	25-622-35	25-624-35	25-626-35

				
L = 40 cm	25-620-40	25-622-40	25-624-40	25-626-40
L = 45 cm	25-620-45	25-622-45	25-624-45	25-626-45
L = 50 cm	25-620-50	25-622-50	25-624-50	25-626-50
L = 55 cm	25-620-55	25-622-55	25-624-55	25-626-55
L = 60 cm	25-620-60	25-622-60	25-624-60	25-626-60



Broncho - Laryngo - Oesophagoskopie
Laryngeal Mirrors
Kehlkopfspiegel
Espejos laringeos

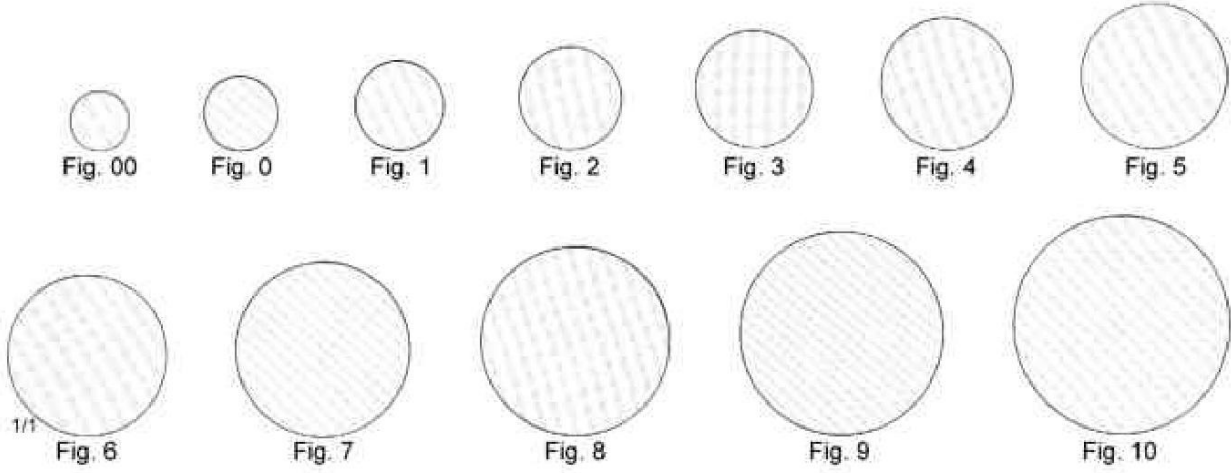

plane, with fixed handle



plane, without handle



Fig.	Ø mm	25-650-08	25-654-08
00	8	25-650-08	25-654-08
0	10	25-650-10	25-654-10
1	12	25-650-12	25-654-12
2	14	25-650-14	25-654-14
3	16	25-650-16	25-654-16
4	18	25-650-18	25-654-18
5	20	25-650-20	25-654-20
6	22	25-650-22	25-654-22
7	24	25-650-24	25-654-24
8	26	25-650-26	25-654-26
9	28	25-650-28	25-654-28
10	30	25-650-30	25-654-30



Broncho - Laryngo - Oesophagoskopie
Laryngeal Mirrors
Kehlkopfspiegel
Espejos laringeos

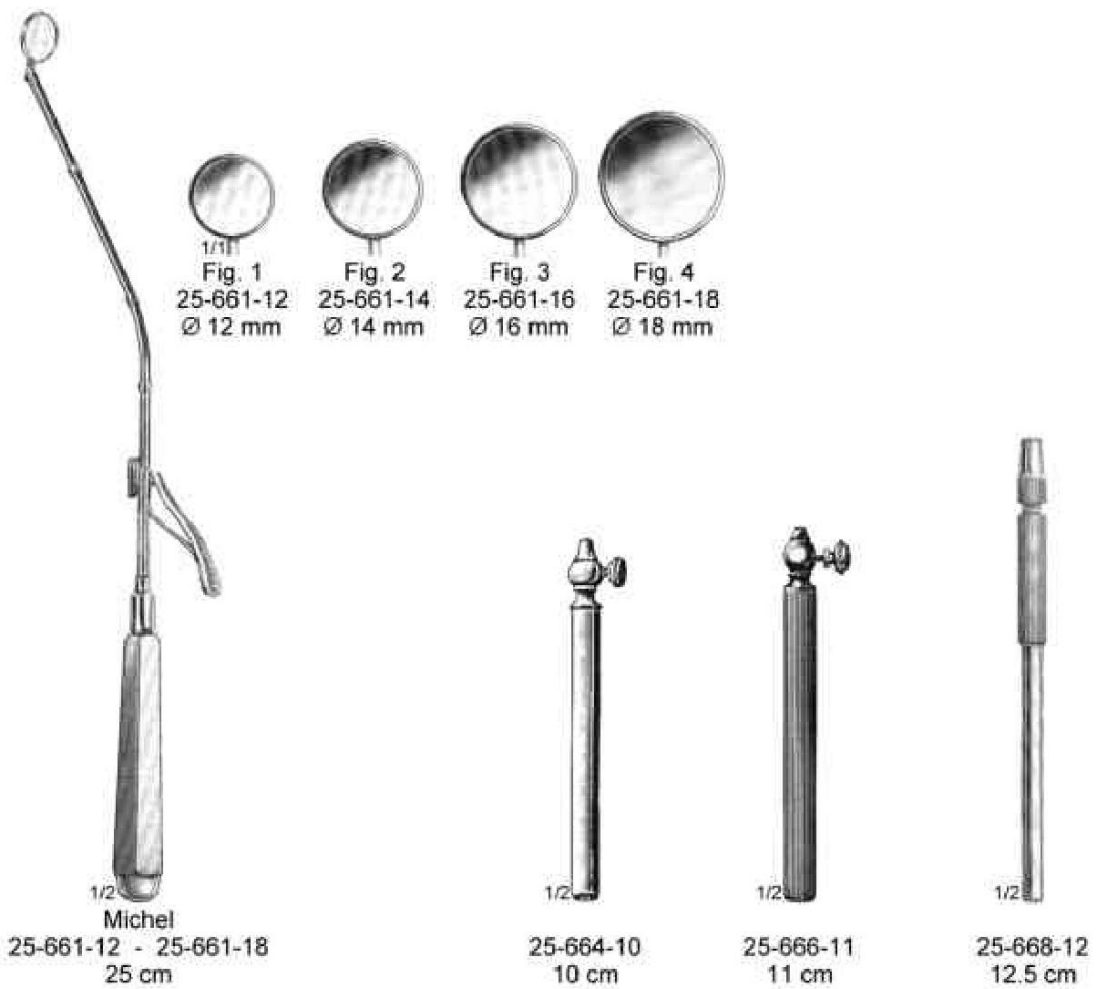

Broncho - Laryngo - Oesophagoskopie
Laryngeal polypus Forceps, Epiglottis retractor
Kehlkopfpolypenzangen, Deckelhalter
Pinzas para polipos laringeos, depresor para epiglottis

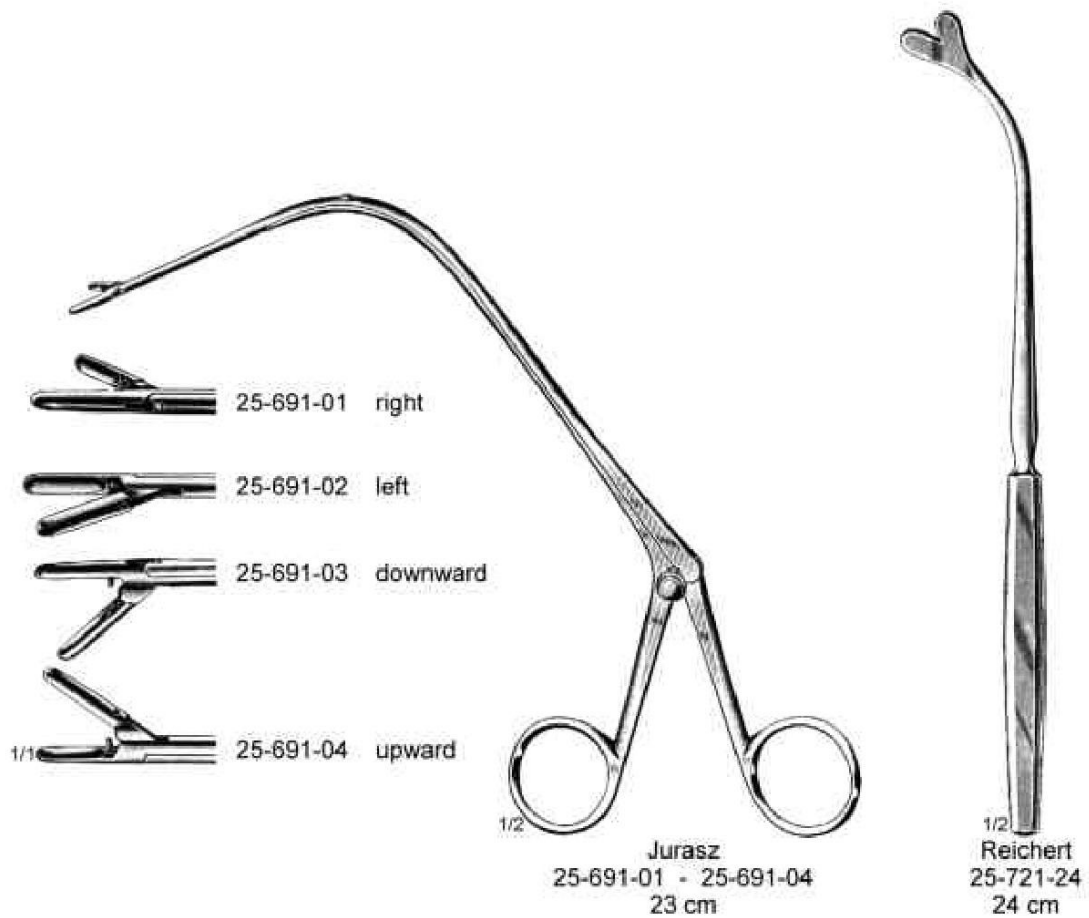



Broncho - Laryngo - Oesophagoskopie
Laryngeal polypus Forceps
Kehlkopfpolypenzangen
Pinzas para polipos laringeos

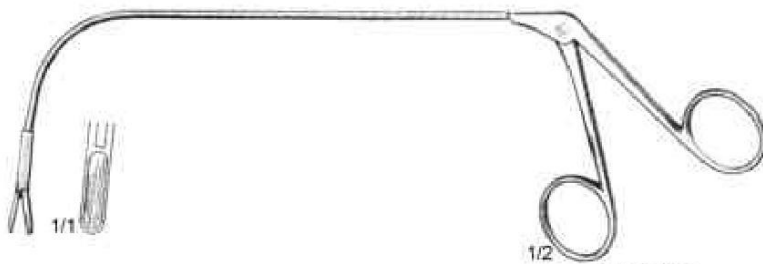

1/2
Fraenkel
25-751-26
26.5 cm

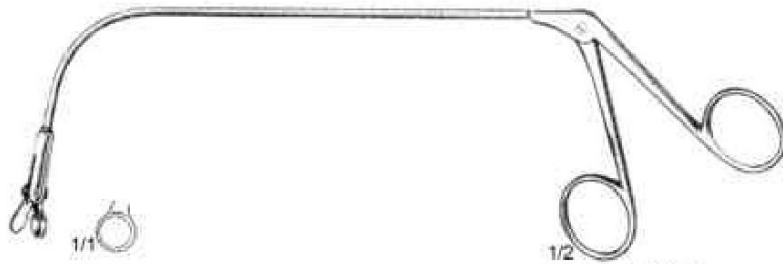

1/2
Lange
25-755-26
26.5 cm

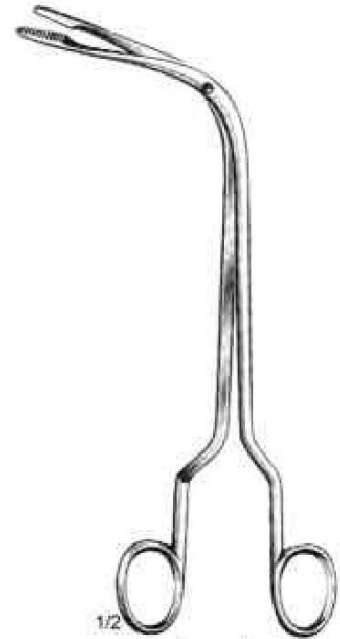

1/2
Fraenkel
25-785-18
18 cm