

# Index



sales@sarwarsons.com

## A

|                                     |            |   |              |
|-------------------------------------|------------|---|--------------|
| Andrew Tongue Depressor             | 52-45      | Crane Pick Root Elevators                       | 51-2         |
| Abell Contouring Pliers             | 57-10      | Crane-Kaplan Periodontia Instruments            | 54-13, 54-14 |
| Adams Bending Pliers                | 57-5       | Crile Artery Forceps                            | 52-19        |
| Aderer Bending Pliers               | 57-5       | Crile-Murray Needle Holder                      | 52-29        |
| Adson Dressing Forceps              | 52-15      | Crile-Wood Needle Holder                        | 52-29        |
| Adson Dressing Forceps with TC      | 52-15      | Crile-Wood Needle Holder with TC                | 52-29        |
| Ainsworth Rubber dam Instruments    | 55-19      | Cross Periodontia Instruments                   | 54-15        |
| Alcohol Burners                     | 52-55      | Cryer Extracting Forceps                        | 50-30, 50-31 |
| Allis Tissue Forceps                | 52-42      | Cryer Root Elevators                            | 51-2         |
| Allis-Baby Tissue Forceps           | 52-42      | Cumine Scalars                                  | 54-6         |
| Alm Retractor                       | 52-26      | Cushing Dressing Forceps                        | 52-16        |
| Amalgam Instruments                 | 55-4, 55-6 | Cushing Dressing Forceps with TC                | 52-16        |
| Andersen Bending Pliers             | 57-4       | Cushing Tissue Forceps                          | 52-16        |
| Angle Bending Pliers                | 57-5       | Cuticle Nipper, Cuticle Scissors and Nail Files | 52-51        |
| Antkoviak Wax and Modelling Carvers | 56-8       | Cutting Instruments                             | 54-24, 54-26 |
| Apical Root Elevators               | 51-2       |   |              |
| Apical-Flohr Root Elevators         | 51-2       |   |              |
| Arruga Needle Holders               | 52-27      |   |              |
| Arruga Needle Holders with TC       | 52-27      |   |              |
| Arthur Splinter Forceps             | 52-17      |   |              |
| Ash Plastic Filling Instruments     | 55-10      |   |              |

## B

|                                    |              |                               |            |
|------------------------------------|--------------|-------------------------------|------------|
| Babcock Tissue Forceps             | 52-42        | Darby-Perry Excavators        | 54-21      |
| Backhaus Towel Forceps             | 52-20        | Darby-Perry Scalars           | 54-5       |
| Baele Wax and Modelling Carvers    | 56-8         | Denhart Mouth Gag             | 52-43      |
| Beavertail Amalgam Instruments     | 55-4         | Dental Scalars                | 54-4, 54-7 |
| Bee Bee Crown Scissors             | 52-13        | Dental Tweezers               | 54-2, 54-3 |
| Beerendonk Measuring Instrument    | 53-3         | Didner Matrix Retainers       | 55-18      |
| Bein Root Elevators                | 51-4         | Dingmann Bone Holding Forceps | 52-38      |
| Bennet Plastic Filling Instruments | 55-11        | Dumont Flat Nose Pliers       | 57-3       |
| Beyer Bone Rongeurs                | 52-41        |                               |            |
| Bishop Tongue Depressor            | 52-44        |                               |            |
| Blumenthal Bone Rongeurs           | 52-41        |                               |            |
| Boehm Removing Pliers              | 57-7         |                               |            |
| Boley Measuring Instrument         | 53-3         |                               |            |
| Bone Holding Forceps               | 52-38        |                               |            |
| Bone Rongeurs                      | 52-39, 52-41 |                               |            |
| Bow Measuring Instrument           | 53-3         |                               |            |
| Brewer Rubber dam Instruments      | 55-20        |                               |            |
| Brophy Dressing Forceps            | 52-16        |                               |            |
| Brophy Tissue Forceps              | 52-16        |                               |            |
| Bruenings Tongue Depressor         | 52-47        |                               |            |
| Buchwald Tongue Depressor          | 52-47        |                               |            |
| Burnishers                         | 55-7         |                               |            |

## C

|  |              |  |  |
|--|--------------|--|--|
| Cartridge Syringes                       | 51-10        |  |  |
| Castroviejo Micro Needle Holders         | 52-27        |  |  |
| Castroviejo Micro Needle Holders with TC | 52-27        |  |  |
| Cement Spatulas                          | 55-14, 55-15 |  |  |
| Cheatle Sterilizing Forceps              | 52-53        |  |  |
| Cheek and Lip Retractors                 | 52-44        |  |  |
| Cheek Holder                             | 51-13        |  |  |
| Chompert Root Elevators                  | 51-8         |  |  |
| Cleveland Bone Rongeurs                  | 52-40        |  |  |
| Coleman Root Elevators                   | 51-3         |  |  |
| Colling Tongue Holding Forceps           | 52-48        |  |  |
| Columbia Scalars                         | 54-6         |  |  |
| Coupland Root Elevators                  | 51-3         |  |  |



|  |              |   |              |
|--|--------------|---|--------------|
| Goldman-Fox Periodontia Instruments      | 54-10, 54-11 | Langer Scalers                                | 54-7         |
| Gordon Contouring Pliers                 | 57-10        | Lawrence-Read Extracting Forceps              | 50-11        |
| Gracey Periodontia Instruments           | 54-12        | Lawrence-Read Extracting Forceps for children | 50-18        |
| Gross-Maier Dressing Forceps             | 52-21        | Le Cron Wax and Modelling Carvers             | 56-7         |
| <b>H</b>                                 |              | Lecluse Root Elevators                        | 51-6         |
| Haas Tongue Depressor                    | 52-47        | Locklin Gum Scissors                          | 52-9         |
| Halsey Needle Holders                    | 52-28        | Locklin Gum Scissors with TC                  | 52-9         |
| Halsey Needle Holders with TC            | 52-28        | London College Dental Tweezers                | 54-2         |
| Halstead-Mosquito Artery Forceps         | 52-18        | Lucas Bone Curettes                           | 52-37        |
| Handles for Mouth Mirrors                | 51-14        | Luer Bone Rongeurs                            | 52-41        |
| Harris Extracting Forceps                | 50-23, 50-24 | Luks Nerve Instruments                        | 54-27        |
| Harrison Sterilizing Forceps             | 52-54        | <b>M</b>                                      |              |
| Hartmann Tongue Depressor                | 52-45        | Martini Bone Curettes                         | 52-36        |
| Hauer Periodontia Instruments            | 54-15        | Mathieu Needle Holders                        | 52-31        |
| Hegar-Baumgartner Needle Holders         | 52-28        | Mathieu Needle Holders with TC                | 52-32        |
| Hegar-Baumgartner Needle Holders with TC | 52-28        | Mathieu-Delicate Needle Holders               | 52-31        |
| Heidebrink Root Elevators                | 51-8         | Mathieu-Delicate Needle Holders with TC       | 52-32        |
| Heidemann Plastic Filling Instruments    | 55-10        | Matrix Bands                                  | 55-16, 55-18 |
| Heister Mouth Gag                        | 52-43        | Mayo Tongue Depressor                         | 52-46        |
| Hemingway Bone Curettes                  | 52-37        | Mayo-Hegar Needle Holders                     | 52-29        |
| Henahan Extracting Forceps               | 50-21        | Mayo-Hegar Needle Holders with TC             | 52-29        |
| Hollenback Instruments for Amalgam       | 55-2         | McCall Periodontia Instruments                | 54-8         |
| Hollenback Wax and Modelling Carvers     | 56-6         | McCall Scalars                                | 54-5         |
| How Contouring Pliers                    | 57-9         | McKellops Bending Pliers                      | 57-4         |
| Hull Extracting Forceps                  | 50-29        | Mead Bone Rongeurs                            | 52-40        |
| Hygenist Periodontia Instruments         | 54-8         | Mead Extracting Forceps                       | 50-16        |
| Hylin Root Elevators                     | 51-4         | Mead Mallets                                  | 52-35        |
| Hylin Wax and Modelling Carvers          | 56-7         | Measuring Instruments                         | 53-2, 53-3   |
| <b>I</b>                                 |              | Meriam Dental Tweezers                        | 54-3         |
| Impression Trays                         | 56-2, 56-3   | Mershon Instruments for Crown Work            | 56-9         |
| Instruments for Amalgam                  | 55-2, 55-3   | Metzenbaun Dissecting Scissors                | 52-7         |
| Instruments for Crown Work               | 56-9, 56-10  | Metzenbaun Dissecting Scissors with TC        | 52-7         |
| Interproximal Wax and Modelling Carvers  | 56-6         | Middledorpf Retractor                         | 52-24        |
| Iris Fine Operating Scissors             | 52-11        | Miller Instruments for Crown Work             | 56-9, 56-10  |
| Iris Fine Operating Scissors with TC     | 52-11        | Miller Root Elevators                         | 51-2         |
| Ivory Amalgam Instruments                | 55-6         | Mini-Friedman Bone Rongeur                    | 52-39        |
| Ivory Matrix Retainers                   | 55-16, 55-17 | Mini-Lexer Bone Chisels                       | 52-34        |
| Ivory Rubber dam Instruments             | 55-19, 55-22 | Mitchell Scalars                              | 54-6         |
| Iwanson Measuring Instrument             | 53-3         | Mod. Martin Retractors                        | 52-44        |
| <b>J</b>                                 |              | Mod. Paris Instruments for Crown Work         | 56-9         |
| Jaquette Periodontia Instruments         | 54-9         | Mod. Plastic Filling Instruments              | 55-8, 55-9   |
| Jaquette Scalars                         | 54-5         | Mod. USA Instruments for Amalgam              | 55-2         |
| Jhonson Contouring Pliers                | 57-10        | Molt Mouth Gags                               | 52-43        |
| Joseph Operating Scissors                | 52-8         | Moritz-Schmidt Tongue Depressor               | 52-46        |
| <b>K</b>                                 |              | Mouth Gags                                    | 52-43        |
| Kells Extracting Forceps                 | 50-28        | Mouth Mirrors                                 | 51-12        |
| Kelly Artery Forceps                     | 52-18        | <b>N</b>                                      |              |
| Kirkland Periodontia Instruments         | 54-14        | Nabers Periodontia Instruments                | 54-15        |
| Klein Extracting Forceps                 | 50-19        | Nail Scissors and Nail Nippers                | 52-50        |
| Kocher (Ochsner) Artery Forceps          | 52-19        | Narrow Dressing Forceps                       | 52-14        |
| Kocher-Langenbeck Retractor              | 52-24        | Nerve Instruments                             | 54-27, 54-28 |
| Korkhaus Removing Pliers                 | 57-8         | Nevius Extracting Forceps                     | 50-28, 50-30 |
| Krallenheber Root Elevators              | 51-6         | Noyes Fine Scissors                           | 52-12        |
| Kroenig Tongue Depressor                 | 52-46        | Nystroem Matrix Retainers                     | 55-17        |
| <b>L</b>                                 |              | <b>O</b>                                      |              |
| La Grange Scissors                       | 52-12        | Obwegeser Chisel                              | 52-49        |
| Langenbeck Flat Nose Pliers              | 57-2, 57-3   | Obwegeser Osteotome Maxillo-Facial            | 52-49        |
| Langenbeck Retractor                     | 52-23        | Ochsenbein Periodontia Instruments            | 54-17        |



|                                      |              |   |              |
|--------------------------------------|--------------|---|--------------|
| Odgen-Felsch Extracting Forceps      | 50-13        | Taylor Dressing Forceps                 | 52-15        |
| Oliver Jones Removing Pliers         | 57-7         | Thomas Wax and Modelling Carvers        | 56-4         |
| Oliver Removing Pliers               | 57-7         | Tobold Tongue Depressors                | 52-45        |
| Olsen-Hegar Needle Holders           | 52-30        | Toennis Needle Holder                   | 52-33        |
| Olsen-Hegar Needle Holders with TC   | 52-30        | Toennis Needle Holder with TC           | 52-33        |
| Osteotome Maxillo-Facial Surgery     | 52-49        | Tofflemire Matrix Bands                 | 55-17        |
| <b>P</b>                             |              | Tofflemire Matrix Retainers             | 55-17, 55-18 |
| Palmer Rubber dam Instruments        | 55-20        | Tomes Extracting Forceps                | 50-27        |
| Parmly Extracting Forceps            | 50-25        | Tongue Depressors                       | 52-44, 52-47 |
| Partsch Bone Chisels                 | 52-34        | Towner-Jaquette Periodontia Instruments | 54-8         |
| Partsch Bone Gouges                  | 52-34        | Treyemann Instruments for Crown Work    | 56-10        |
| Pean Artery Forceps                  | 52-18        | Triplex Contouring Pliers               | 57-10        |
| Peeso Contouring Pliers              | 57-9         | Tryfus Contouring Pliers                | 57-9         |
| Peet Splinter Forceps                | 52-17        | Tuft Wax and Modelling Carvers          | 56-5         |
| Periodontia Instruments              | 54-8, 54-18  | <b>U</b>                                |              |
| Plastic Filling Instruments          | 55-8, 55-13  | Ulleval Sterilizing Forceps             | 52-54        |
| Pott Root Elevators                  | 51-6         | Univ. Minnesota Tongue Depressor        | 52-46        |
| Prichard Periodontia Instruments     | 54-18        | Universal Pliers                        | 57-6         |
| Probes and Explorers                 | 54-19, 54-20 | Universal Wire Cutting Scissors         | 52-13        |
| Prosthetics and Ortodontia           | 57-2, 57-10  | Universal Wire Cutting Scissors with TC | 52-13        |
| Providence-Hospital Artery Forceps   | 52-18        | <b>V</b>                                |              |
| <b>R</b>                             |              | Volkman Bone Curettes                   | 52-36        |
| Ralk Splinter Forceps                | 52-17        | <b>W</b>                                |              |
| Retractors                           | 52-22, 52-26 | Wagner Fine Operating Scissors          | 52-10        |
| Reynold Contouring Pliers            | 57-10        | Waldsachs-Universal Pliers              | 57-6         |
| Rochester Pean Artery Forceps        | 52-19        | Walter F. Barry Root Elevators          | 51-2         |
| Rogge Sterilizing Forceps            | 52-53        | Walter F. Barry Root Elevators          | 51-5         |
| Root Elevators                       | 51-2, 51-9   | Walter F. Barry Root Elevators          | 51-9         |
| Roser-Konig Mouth Gags               | 52-43        | Ward Wax and Modelling Carvers          | 56-5         |
| Roux Retractor                       | 52-26        | Ward-Kirkland Periodontia Instruments   | 54-13        |
| Rubber dam Instruments               | 55-19, 55-22 | Warwick-James Root Elevators            | 51-7         |
| Ruskin Bone Rongeurs                 | 52-41        | Water Syringes                          | 51-11        |
| <b>S</b>                             |              | Wax and Modelling Carvers               | 56-4, 56-8   |
| Sachs Instruments for Crown Work     | 56-9         | Weingart Removing Pliers                | 57-8         |
| Scalpel Handle No. 3                 | 52-2         | Weitlaner-Wullstein Retractor           | 52-26        |
| Scalpel Handle No. 4                 | 52-2         | West Root Elevators                     | 51-9         |
| Scalpel Handle No. 7K                | 52-2         | White Burnishers                        | 55-7         |
| Schaedel Towel Forceps               | 52-20        | White Cutting Instruments               | 54-24        |
| Schroeder Instruments for Crown Work | 56-10        | White Plastic Filling Instruments       | 55-10        |
| Schwarz Bending Pliers               | 57-4         | White Rubber dam Instruments            | 55-21        |
| Secco Mouth Mirror Handle            | 51-14        | White Scalars                           | 54-5         |
| Seldin Root Elevators                | 51-2         | Wieder Tongue Depressors                | 52-45        |
| Semken Dressing Forceps              | 52-15        | Wiland Wax and Modelling Carvers        | 56-6         |
| Senn-Miller Retractors               | 52-23        | Williams Plastic Filling Instruments    | 55-11        |
| Simplex Retractor                    | 52-44        | Williger Bone Curettes                  | 52-36, 52-37 |
| Spencer-Ligature Scissors            | 52-12        | Williger Mallets                        | 52-35        |
| Srieglitz Splinter Forceps           | 52-17        | Winter Root Elevators                   | 51-5         |
| Stadler Bending Pliers               | 57-5         | Witzel Root Fragment Forceps            | 50-33        |
| Standard Dressing Forceps            | 52-14        | Wood(Passow) Extracting Forceps         | 50-13        |
| Standard Extracting Forceps          | 50-21        | Woodson Plastic Filling Instruments     | 55-10        |
| Standard Operating Scissors          | 52-3, 52-5   | Woodwards Extracting Forceps            | 50-22        |
| Standard Operating Scissors with TC  | 52-6         | <b>Y</b>                                |              |
| Standard Tongue Depressor            | 52-46        | Young Bending Pliers                    | 57-5         |
| Stemberg Retractors                  | 52-44        | Young Tongue Holding Forceps            | 52-48        |
| Sterilizing Forceps                  | 52-52, 52-54 | Younger-Good Scalars                    | 54-7         |
| Stevens Needle Holders               | 52-27        | <b>Z</b>                                |              |
| Stocker Rubber dam Instruments       | 55-20        | Zahle Wax and Modelling Carvers         | 56-7         |
|                                      |              | Zenker Retractor                        | 52-25        |

**Extraction - Extraktion - Extracción**  
**Extracting Forceps, English Pattern**  
**Zahnzangen, englische Form**  
**Forceps de extracción, forma inglesa**

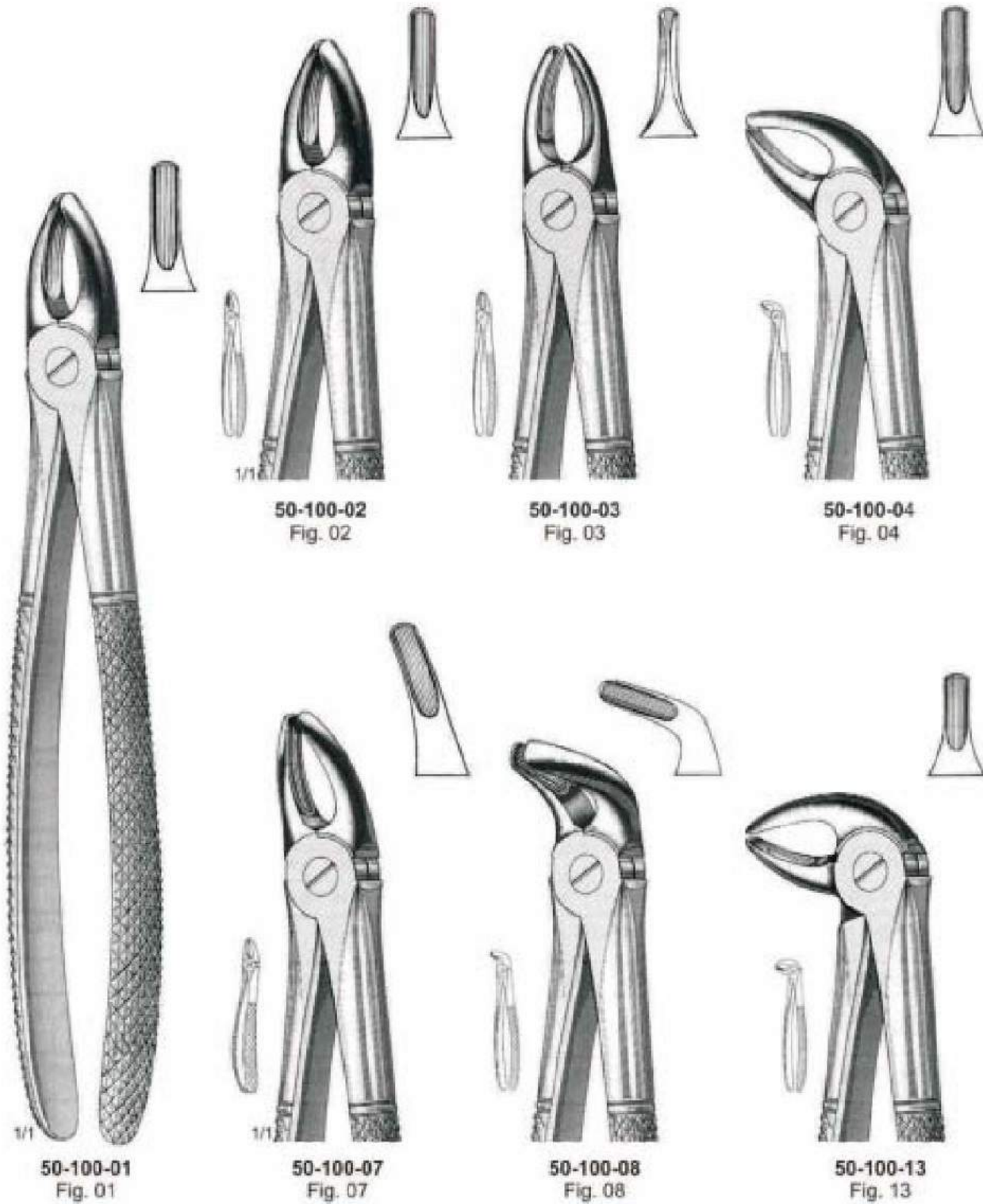

Extraction - Extraktion - Extracción  
 Extracting Forceps, English Pattern  
 Zahnzangen, englische Form  
 Forceps de extracción, forma inglesa

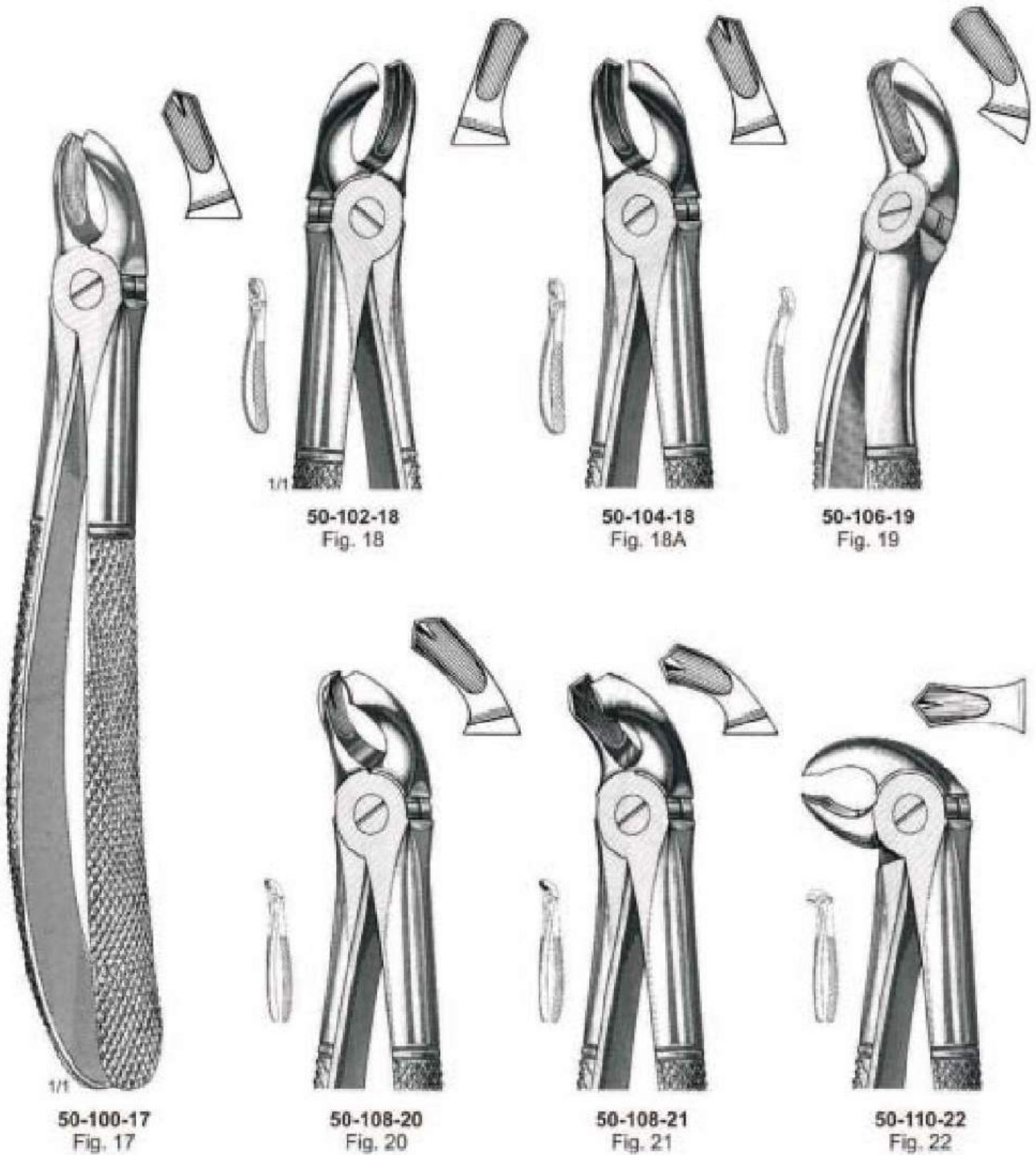

**Extraction - Extraktion - Extracción**  
**Extracting Forceps, English Pattern**  
**Zahnzangen, englische Form**  
**Forceps de extracción, forma inglesa**



**50-110-23**  
Fig. 23



**50-110-24**  
Fig. 24



**50-112-29**  
Fig. 29



**50-114-29**  
Fig. 29N



**50-116-30**  
Fig. 30



**50-118-31**  
Fig. 31

Extraction - Extraktion - Extracción  
 Extracting Forceps, English Pattern  
 Zahnzangen, englische Form  
 Forceps de extracción, forma inglesa



50-118-33  
Fig. 33



50-120-33  
Fig. 33A



50-122-33  
Fig. 33C



50-124-33  
Fig. 33M

Extraction - Extraktion - Extracción  
Extracting Forceps, English Pattern  
Zahnzangen, englische Form  
Forceps de extracción, forma inglesa



1/1

50-126-34  
Fig. 34N



1/1

50-126-35  
Fig. 35N



Extraction - Extraktion - Extracción  
 Extracting Forceps, English Pattern  
 Zahnzangen, englische Form  
 Forceps de extracción, forma inglesa



1/1  
50-126-36  
Fig. 36N

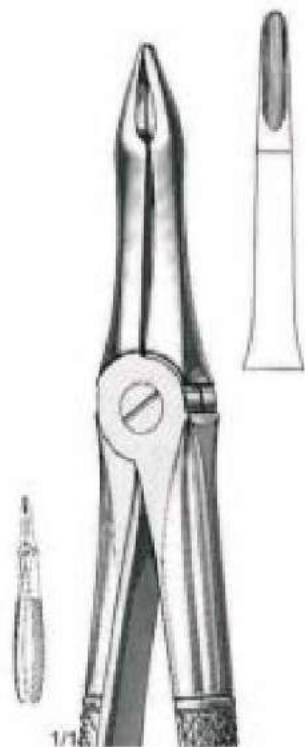

1/16  
50-128-41  
Fig. 41

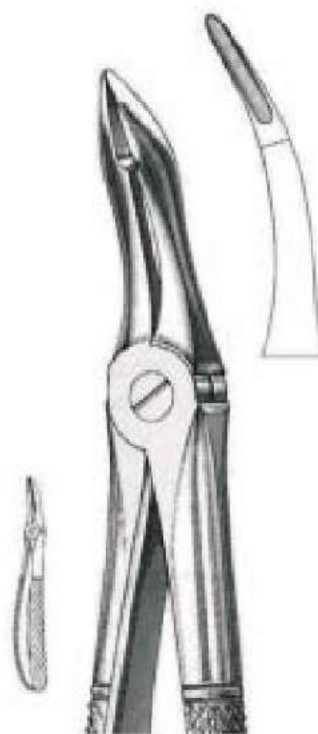

50-128-44  
Fig. 44

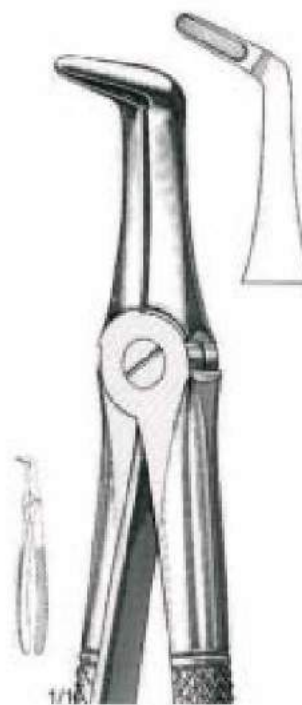

1/16  
50-128-45  
Fig. 45

Extraction - Extraktion - Extracción  
Extracting Forceps, English Pattern  
Zahnzangen, englische Form  
Forceps de extracción, forma inglesa



1/1  
50-128-46  
Fig. 46



1/1  
50-130-46  
Fig. 46L



1/1  
50-132-46  
Fig. 46LX

Extraction - Extraktion - Extracción  
 Extracting Forceps, English Pattern  
 Zahnzangen, englische Form  
 Forceps de extracción, forma inglesa



1/1

50-134-51  
Fig. 51



1/1

50-136-51  
Fig. 51A



1/1

50-138-51  
Fig. 51LX

Extraction - Extraktion - Extracción  
 Extracting Forceps, English Pattern  
 Zahnzangen, englische Form  
 Forceps de extracción, forma inglesa

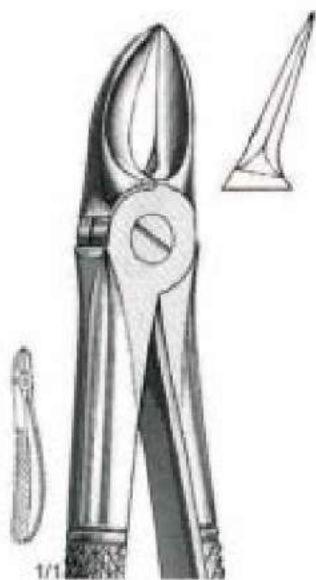

50-140-55  
Fig. 55



50-140-56  
Fig. 56

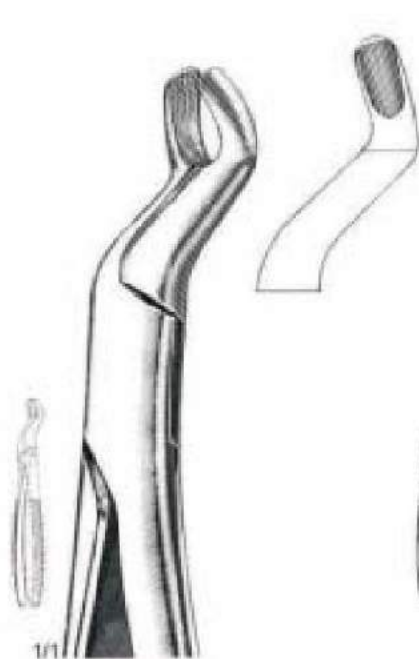

50-142-67  
Fig. 67



50-144-67  
Fig. 67A



50-146-73  
Fig. 73

**Extraction - Extraktion - Extracción**  
**Extracting Forceps, English Pattern**  
**Zahnzangen, englische Form**  
**Forceps de extracción, forma inglesa**



**50-146-74**  
Fig. 74



**50-148-74**  
Fig. 74M



**50-150-74**  
Fig. 74N



**50-150-75**  
Fig. 75

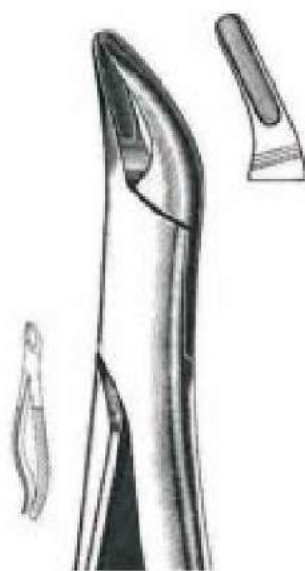

Lawrence-Read  
**50-150-76**  
Fig. 76



Lawrence-Read  
**50-152-76**  
Fig. 76N

**Extraction - Extraktion - Extracción**  
**Extracting Forceps, English Pattern**  
**Zahnzangen, englische Form**  
**Forceps de extracción, forma inglesa**



**50-152-79**  
Fig. 79



**50-154-79**  
Fig. 79A



**50-154-86**  
Fig. 86A



**50-156-86**  
Fig. 86B



**50-158-86**  
Fig. 86C

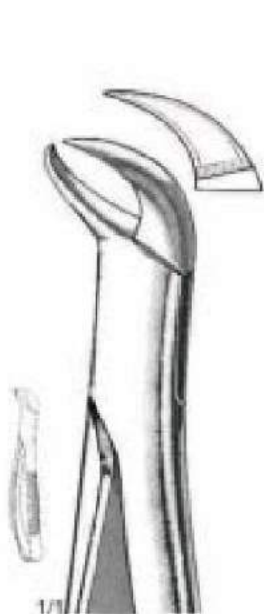

**50-158-87**  
Fig. 87

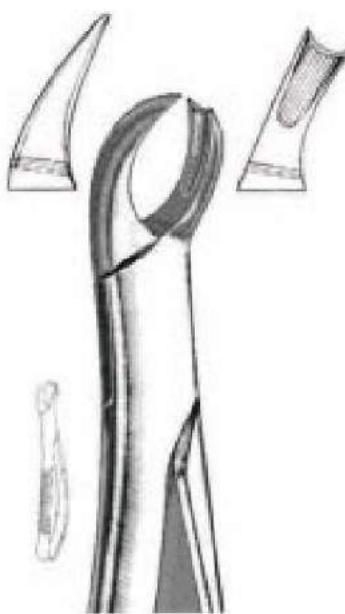

**50-158-89**  
Fig. 89

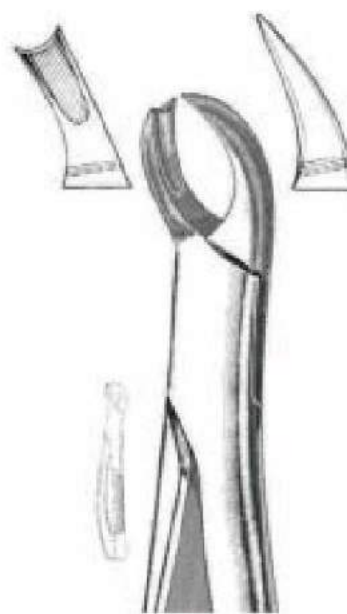

**50-158-90**  
Fig. 90



Extraction - Extraktion - Extracción  
Extracting Forceps, English Pattern  
Zahnzangen, englische Form  
Forceps de extracción, forma inglesa



50-158-94  
Fig. 94



50-158-95  
Fig. 95



Wood (Passow)  
50-158-99  
Fig. 99

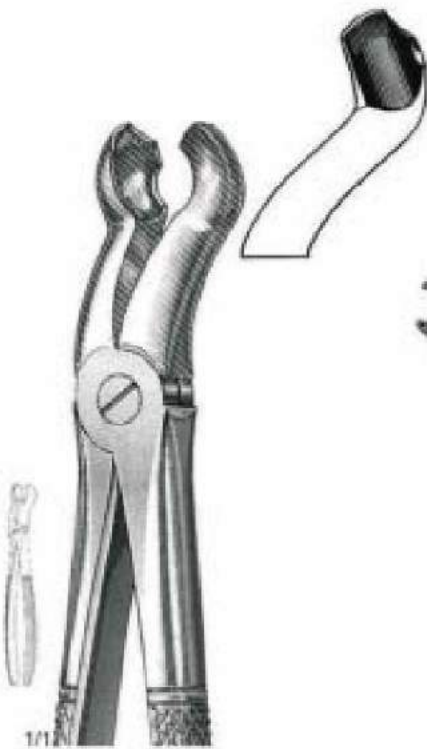

Odgen-Felsch  
50-160-21  
Fig. 121



50-160-33  
Fig. 233



50-160-35  
Fig. 235

Extraction - Extraktion - Extracción  
 Extracting Forceps  
 Zahnzangen  
 Forceps de extracción



50-300-01  
Fig. 1



50-300-02  
Fig. 2

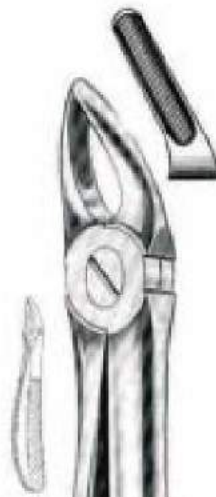

50-302-07  
Fig. 7



50-302-17  
Fig. 17



50-304-18  
Fig. 18



50-306-30  
Fig. 30



50-306-39  
Fig. 39



50-308-51  
Fig. 51



50-310-51  
Fig. 51A



Extraction - Extraktion - Extracción  
 Extracting Forceps  
 Zahnzangen  
 Forceps de extracción



50-310-67  
Fig. 67



50-310-73  
Fig. 73



50-310-74  
Fig. 74



50-312-74  
Fig. 74N



50-312-79  
Fig. 79



50-320-13  
Fig. 13



50-322-13  
Fig. 13S



50-322-22  
Fig. 22



50-322-33  
Fig. 33

**Extraction - Extraktion - Extracción**  
**Extracting Forceps**  
**Zahnzangen**  
**Forceps de extracción**



**Mead**  
**50-400-01**  
**Fig. MD 1**



**Mead**  
**50-400-02**  
**Fig. MD 2**



**Mead**  
**50-400-03**  
**Fig. MD 3**



**Mead**  
**50-400-04**  
**Fig. MD 4**

**Extraction - Extraktion - Extracción**  
**Extracting Forceps for children, English Pattern**  
**Kinderzahnzangen, englische Form**  
**Forceps de extracción para niños, forma inglesa**

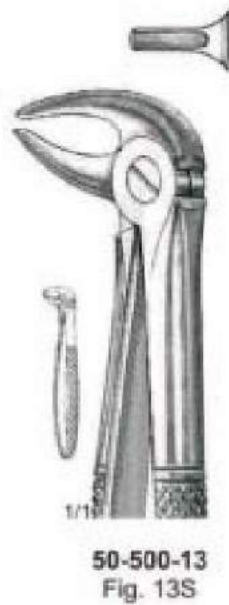

**Extraction - Extraktion - Extracción**  
**Extracting Forceps for children, English Pattern**  
**Kinderzahnzangen, englische Form**  
**Forceps de extracción para niños, forma inglesa**



50-500-39  
Fig. 39



50-502-39  
Fig. 39A



50-504-39  
Fig. 39L



50-506-39  
Fig. 39R



50-506-40  
Fig. 40



50-506-51  
Fig. 51S

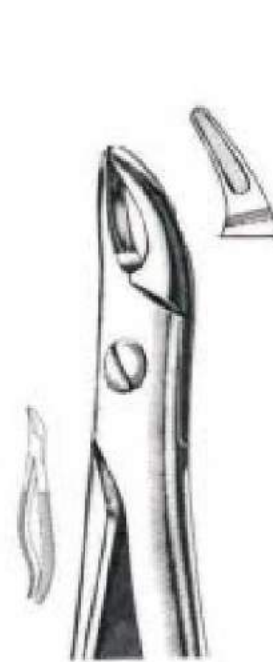

Lawrence-Read  
50-506-76  
Fig. 76S

**Extraction - Extraktion - Extracción**  
**Extracting Forceps for children, with spring**  
**Kinderzahnzangen, mit Feder**  
**Forceps de extracción para niños, con resorte**

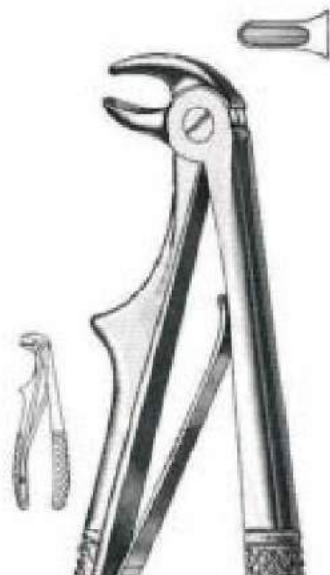

Klein  
50-600-05  
Fig. 5

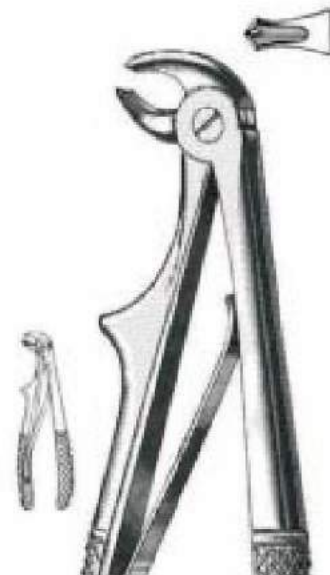

Klein  
50-600-06  
Fig. 6

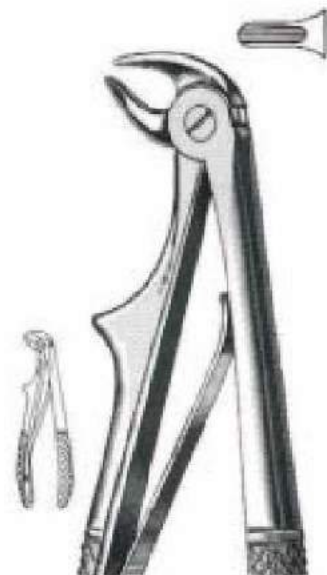

Klein  
50-600-07  
Fig. 7



Klein  
50-600-03  
Fig. 3



Klein  
50-600-37  
Fig. 37



Klein  
50-600-39  
Fig. 39



Klein  
50-600-51  
Fig. 51S

**Extraction - Extraktion - Extracción**  
**Extracting Forceps for children, American Pattern**  
**Kinderzahnzangen, amerikanische Form**  
**Forceps de extracción para niños, forma americana**



**50-620-17**  
**Fig. 17SK**



**50-620-23**  
**Fig. 23SK**



**50-620-50**  
**Fig. 150SK**



**50-622-51**  
**Fig. 151SK**

Extraction - Extraktion - Extracción  
Extracting Forceps, American Pattern  
Zahnzangen, amerikanische Form  
Forceps de extracción, forma americana



Standard  
50-640-01  
Fig. 1

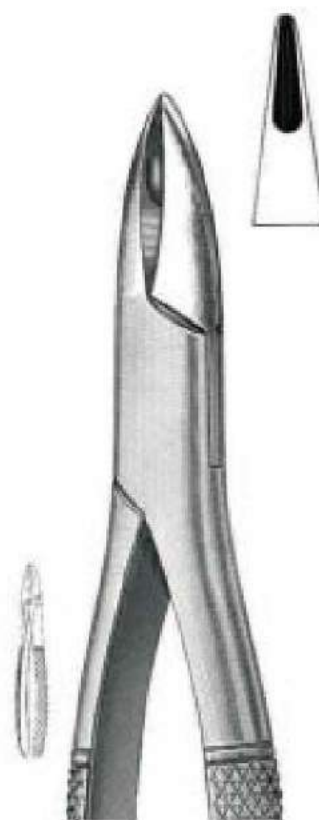

Henahan  
50-642-01  
Fig. 1A



Extraction - Extraktion - Extracción  
Extracting Forceps, American Pattern  
Zahnzangen, amerikanische Form  
Forceps de extracción, forma americana



Woodwards  
50-650-03  
Fig. 3FS

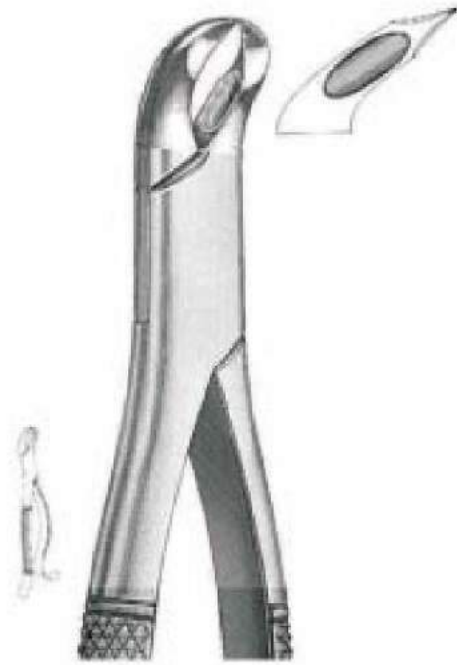

Woodwards  
50-652-03  
Fig. 3FH

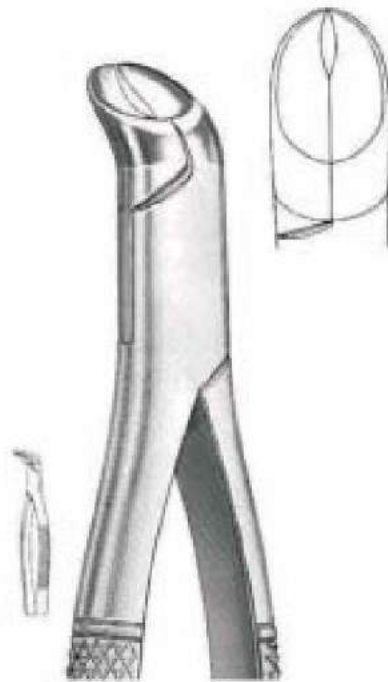

Physick  
50-654-05  
Fig. 5

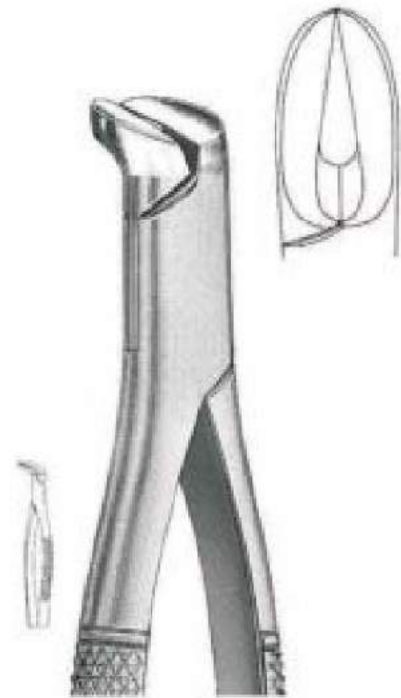

50-654-06  
Fig. 6



Extraction - Extraktion - Extracción  
 Extracting Forceps, American Pattern  
 Zahnzangen, amerikanische Form  
 Forceps de extracción, forma americana



50-660-10  
Fig. 10H



50-662-10  
Fig. 10S



1/1

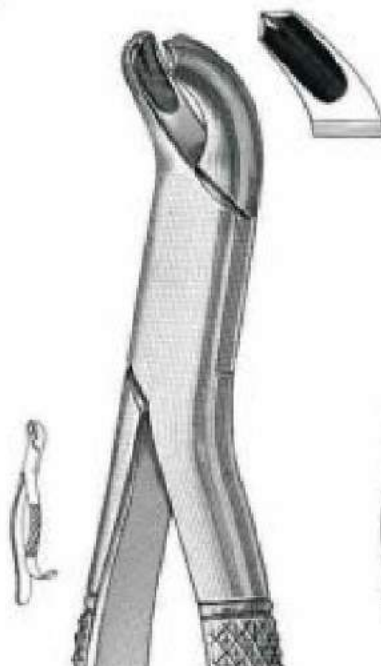

Harris  
50-664-15  
Fig. 15

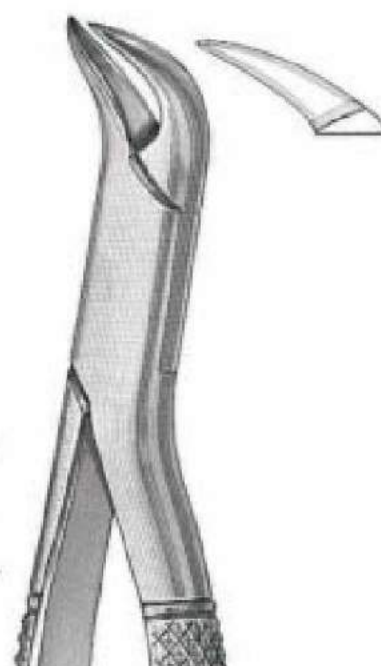

50-664-16  
Fig. 16

Extraction - Extraktion - Extracción  
 Extracting Forceps, American Pattern  
 Zahnzangen, amerikanische Form  
 Forceps de extracción, forma americana

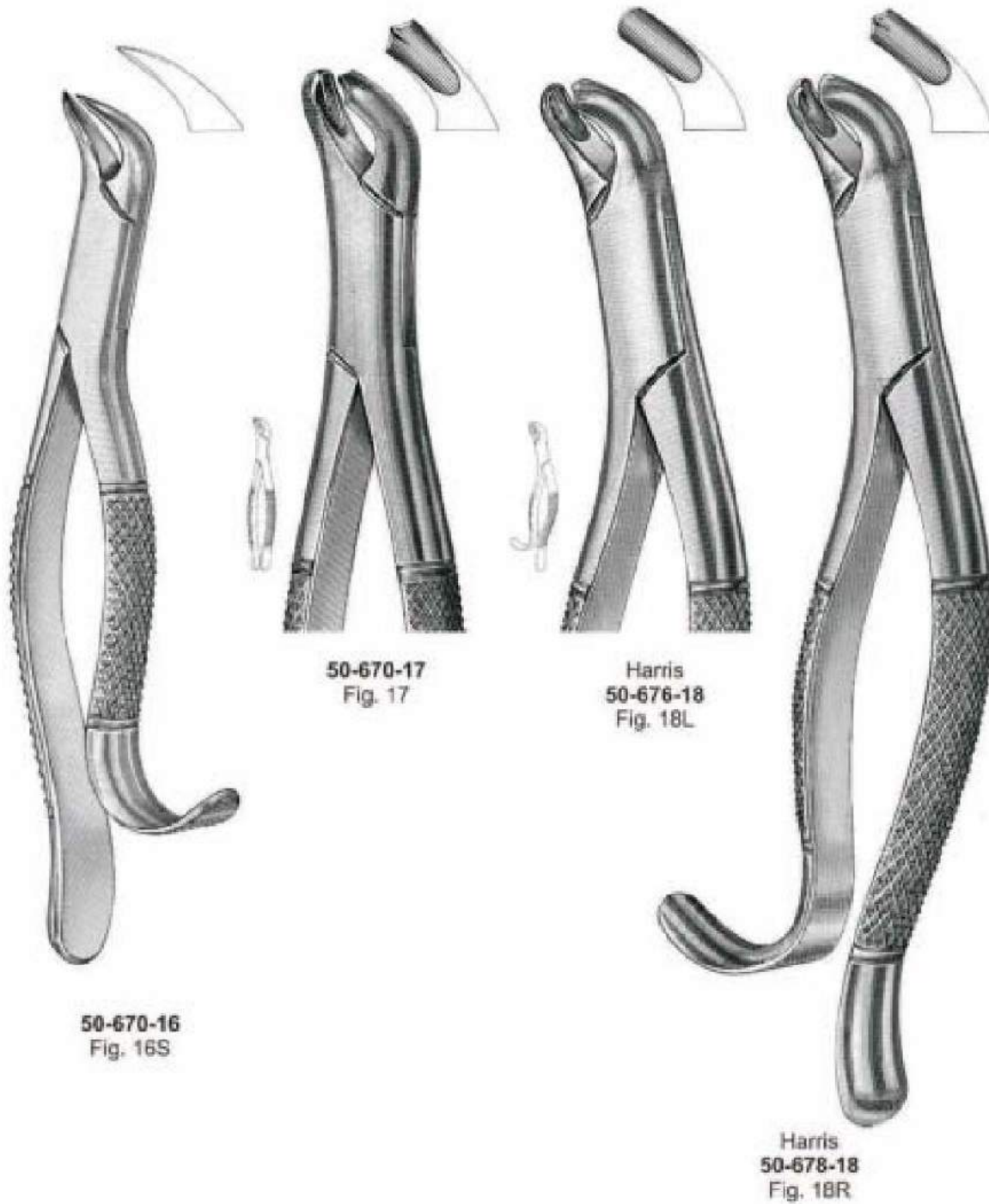

Extraction - Extraktion - Extracción  
 Extracting Forceps, American Pattern  
 Zahnzangen, amerikanische Form  
 Forceps de extracción, forma americana



50-680-23  
Fig. 23



50-680-24  
Fig. 24



50-680-27  
Fig. 27

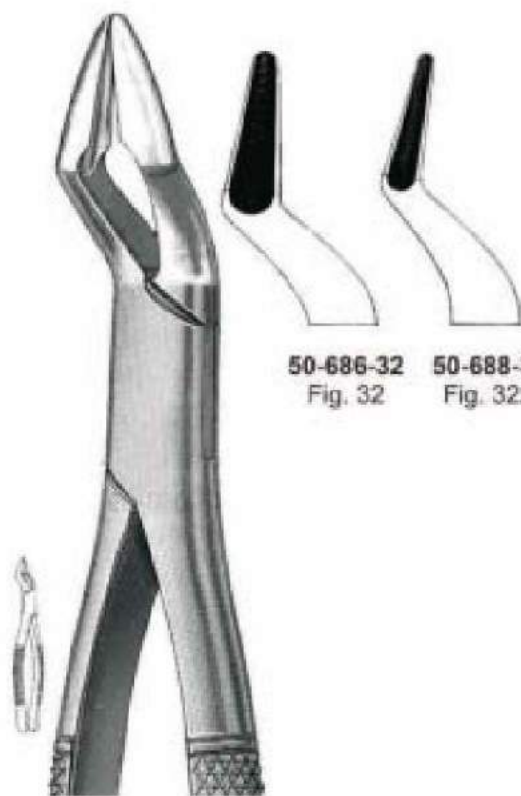

50-686-32 50-688-32  
Fig. 32 Fig. 32A

Parmlj  
50-686-32 - 50-688-32

Extraction - Extraktion - Extracción  
Extracting Forceps, American Pattern  
Zahnzangen, amerikanische Form  
Forceps de extracción, forma americana

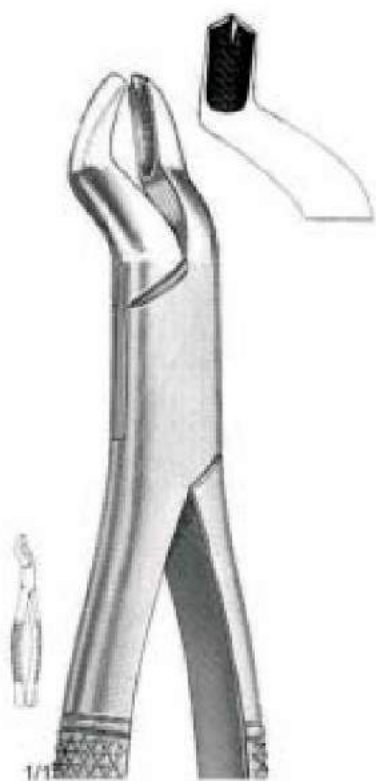

50-700-53  
Fig. 53L

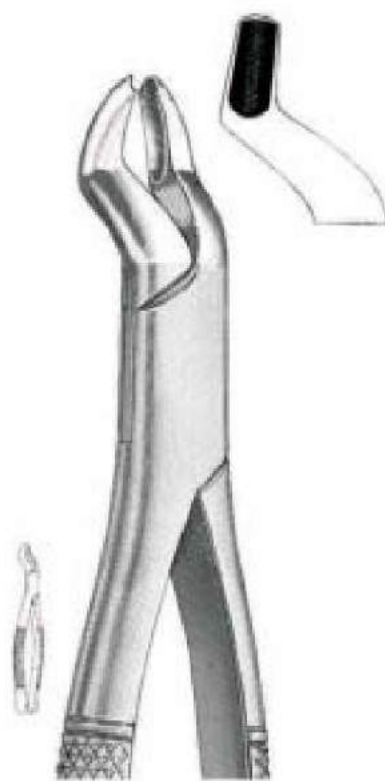

50-702-53  
Fig. 53R

Extraction - Extraktion - Extracción  
 Extracting Forceps, American Pattern  
 Zahnzangen, amerikanische Form  
 Forceps de extracción, forma americana



50-720-62  
Fig. 62

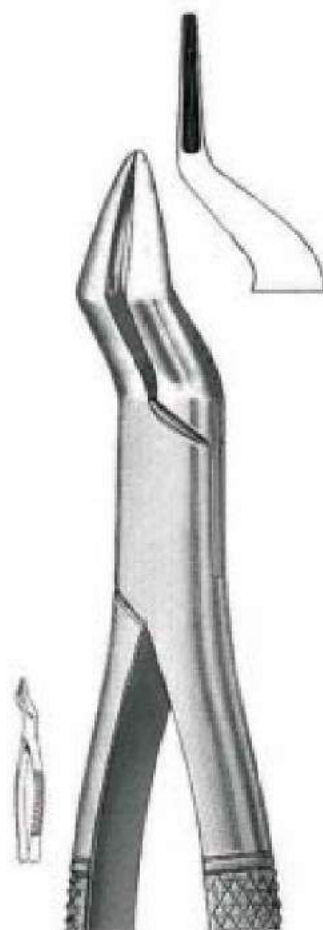

50-720-65  
Fig. 65



Tomes  
50-720-69  
Fig. 69

**Extraction - Extraktion - Extracción**  
**Extracting Forceps, American Pattern**  
**Zahnzangen, amerikanische Form**  
**Forceps de extracción, forma americana**



**Nevius**  
**50-740-88**  
**Fig. 88L**



**Nevius**  
**50-742-88**  
**Fig. 88R**



**Kells**  
**50-748-99**  
**Fig. 99A**

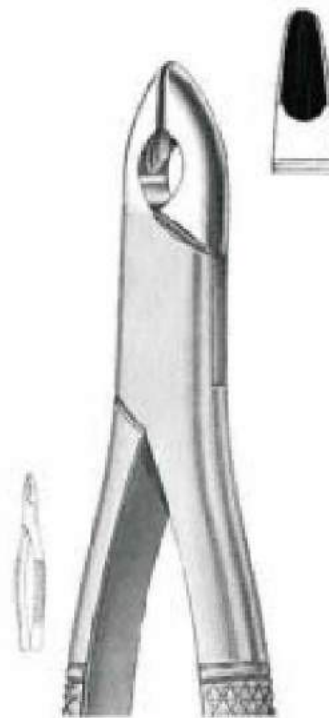

**Kells**  
**50-750-99**  
**Fig. 99C**

Extraction - Extraktion - Extracción  
Extracting Forceps, American Pattern  
Zahnzangen, amerikanische Form  
Forceps de extracción, forma americana



Hull  
50-760-01  
Fig. 101



50-760-03  
Fig. 103

Extraction - Extraktion - Extracción  
 Extracting Forceps, American Pattern  
 Zahnzangen, amerikanische Form  
 Forceps de extracción, forma americana



Nevius  
 50-760-10  
 Fig. 110



Nevius  
 50-762-10  
 Fig. 110



Cryer  
 50-762-50  
 Fig. 150



Cryer  
 50-764-50  
 Fig. 150A



Extraction - Extraktion - Extracción  
 Extracting Forceps, American Pattern  
 Zahnzangen, amerikanische Form  
 Forceps de extracción, forma americana

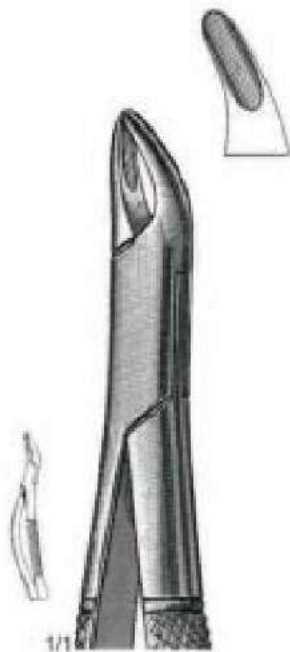

Cryer  
50-764-50  
Fig. 150S



Cryer  
50-764-51  
Fig. 151



Cryer  
50-766-51  
Fig. 151A

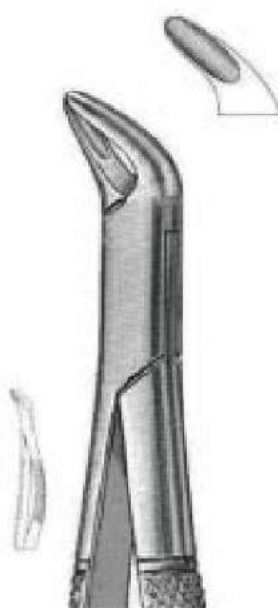

Cryer  
50-768-51  
Fig. 151S



50-770-03  
Fig. 203



Extraction - Extraktion - Extracción  
Extracting Forceps, American Pattern  
Zahnzangen, amerikanische Form  
Forceps de extracción, forma americana



50-780-10  
Fig. 210S

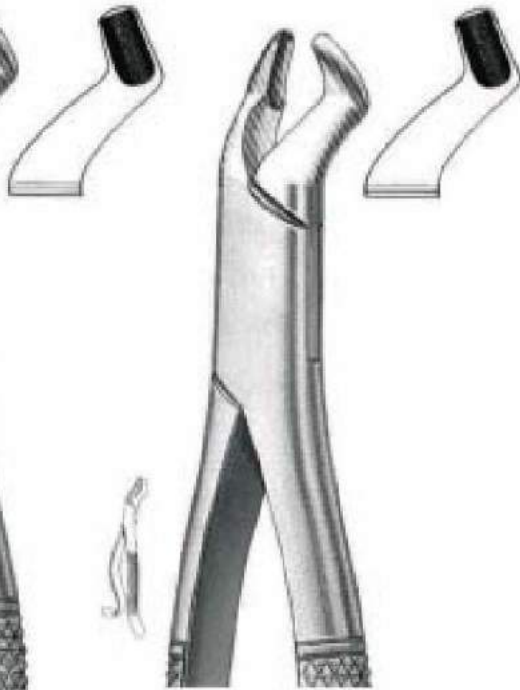

50-782-10  
Fig. 210H



50-784-17  
Fig. 217

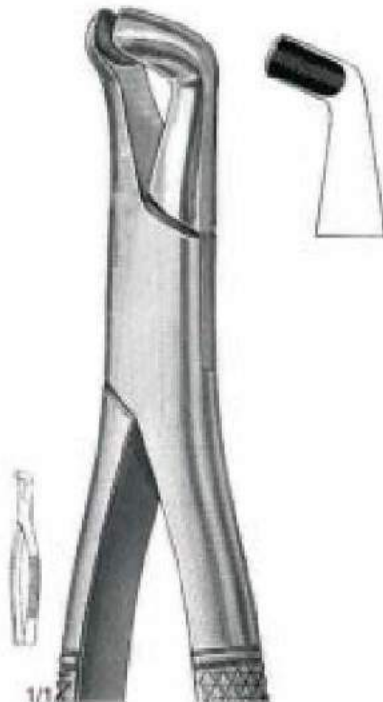

50-784-22  
Fig. 222

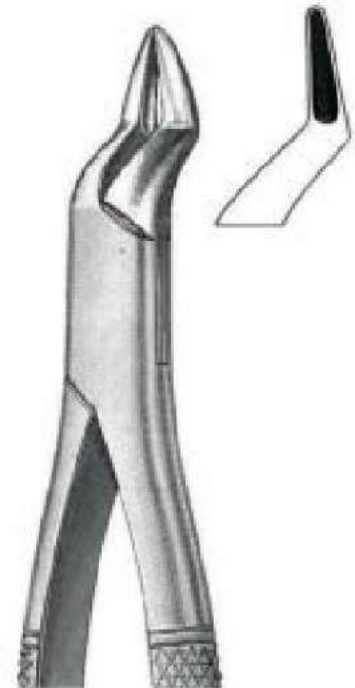

50-784-86  
Fig. 286

Extraction - Extraktion - Extracción  
Root Fragment Forceps  
Wurzelsplitterzangen  
Forceps para fragmentos de raices



Witzel  
50-800-01  
Fig. 501



Witzel  
50-800-02  
Fig. 502

**Extraction - Extraktion - Extracción**  
**Root Elevators**  
**Wurzelhebe**  
**Elvadores para raíces**

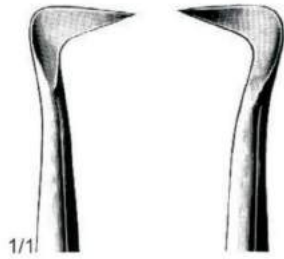

1/1  
**Seldin**  
**51-100-01**  
**Fig. 1L**



**Seldin**  
**51-100-02**  
**Fig. 1R**



**Seldin**  
**51-106-02**  
**Fig. 2**



**Seldin**  
**51-110-03**  
**Fig. 3**



**Cryer**  
**51-112-03**  
**Fig. 3A**



**Seldin**  
**51-116-01**  
**Fig. 4L**



**Seldin**  
**51-116-02**  
**Fig. 4R**



1/1  
**Crane Pick**  
**51-120-06**  
**Fig. 6**



**Miller**  
**51-122-01**  
**Fig. 8**



**Miller**  
**51-122-02**  
**Fig. 9**



**Miller**  
**51-124-01**  
**Fig. 10**



**Miller**  
**51-124-02**  
**Fig. 11**



**Cryer**  
**51-126-12**  
**Fig. 12**



**Cryer**  
**51-128-01**  
**Fig. 27**



**Cryer**  
**51-128-02**  
**Fig. 28**



1/1  
**51-100-01 - 51-164-34**



1/1  
**Seldin**  
**51-140-34**  
**Fig. 34**



**Seldin**  
**51-142-34**  
**Fig. 34S**



**Cryer**  
**51-144-01**  
**Fig. 39**



**Cryer**  
**51-144-02**  
**Fig. 40**



**Flohr**  
**51-146-46**  
**Fig. 46**



**Walter F. Barry**  
**51-148-01**  
**Fig. 50**



**Walter F. Barry**  
**51-148-02**  
**Fig. 51**



1/1  
**Apical**  
**51-160-31**  
**Fig. 301**



**Apical-Flohr**  
**51-162-01**  
**Fig. 302**



**Apical-Flohr**  
**51-162-02**  
**Fig. 303**



**Apical**  
**51-164-34**  
**Fig. 304**

**Extraction - Extraktion - Extracción**  
**Root Elevators**  
**Wurzelhebe**  
**Elvadores para raíces**



51-250-01



51-250-02



51-250-03



51-258-20  
2mm



51-258-25  
2.5mm



51-258-30  
3mm

Coleman  
51-250-01 - 51-250-03  
15 cm

Coupland  
51-258-20 - 51-258-30  
14 cm



51-264-01  
Fig. 1



51-264-02  
Fig. 2



51-264-03  
Fig. 3

Friedmann  
51-264-01 - 51-264-03  
14 cm

**Extraction - Extraktion - Extracción**  
**Root Elevators**  
**Wurzelhebe**  
**Elvadores para raíces**



**51-292-03**  
3mm



**51-292-04**  
4mm



**51-280-01**  
3mm



**51-280-02**  
4.5mm



**51-294-03**  
3mm



**51-294-04**  
4mm



**Hylin**  
51-280-01 - 51-290-02



**51-290-01**  
3mm



**51-290-02**  
3mm



**Bein**  
51-292-03 - 51-298-04



**51-298-03**  
3mm



**51-298-04**  
4mm

**Extraction - Extraktion - Extracción**  
**Root Elevators**  
**Wurzelhebe**  
**Elvadores para raíces**

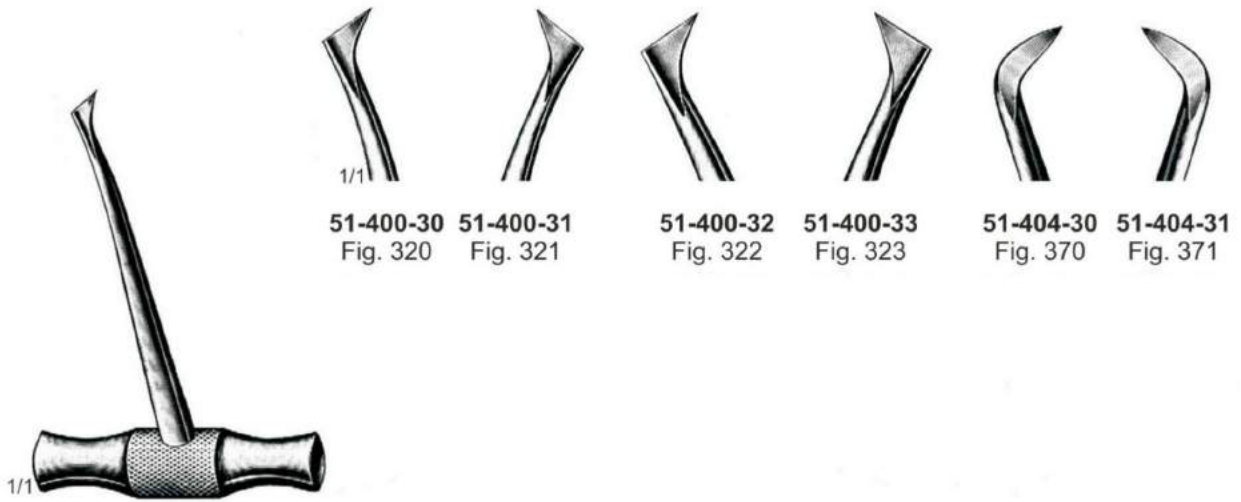

Walter F. Barry  
 51-400-30 - 51-404-31

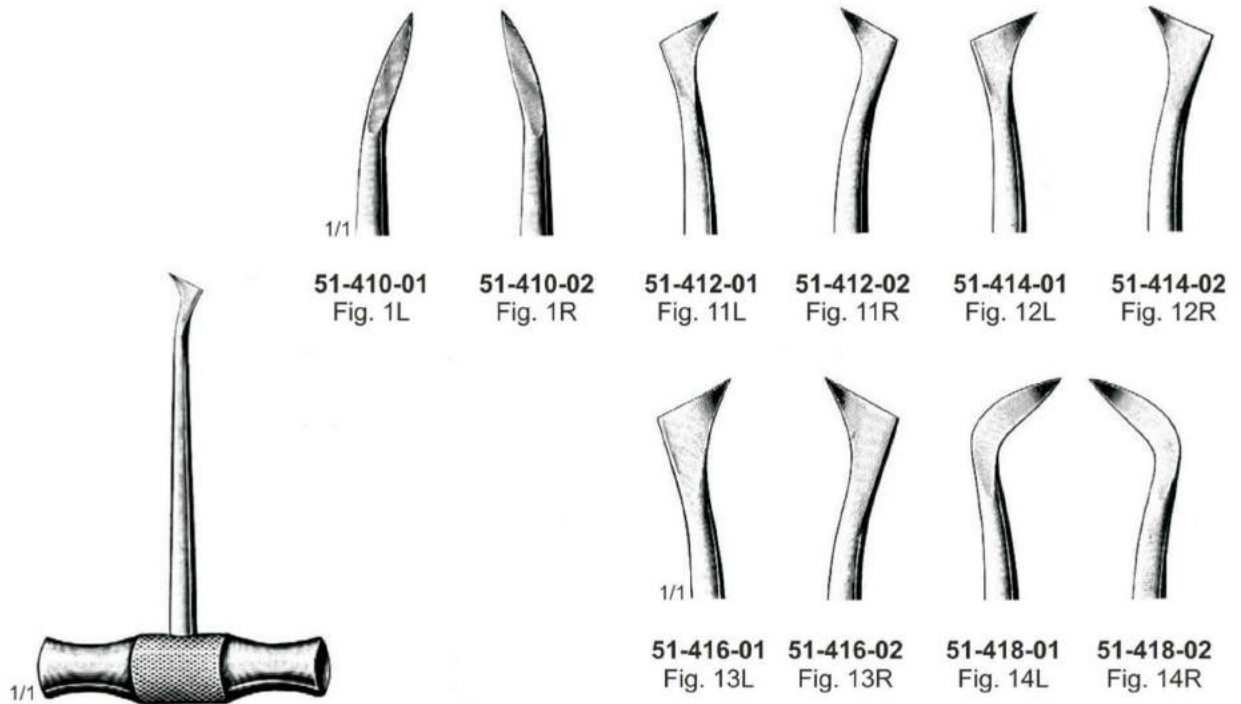

Winter  
 51-410-01 - 51-418-02

**Extraction - Extraktion - Extracción**  
**Root Elevators**  
**Wurzelheber**  
**Elvadores para raíces**



Lecluse  
51-420-01



Pott  
51-430-01 - 51-430-02



Krallenheber  
51-450-01  
Fig. 1



Krallenheber  
51-450-02  
Fig. 2



Extraction - Extraktion - Extracción  
Root Elevators  
Wurzelhebe  
Elevadores para raíces



Warwick-James  
51-480-01



Warwick-James  
51-480-02



Warwick-James  
51-480-03

**Extraction - Extraktion - Extracción  
Root Elevators  
Wurzelheber  
Elevadores para raíces**

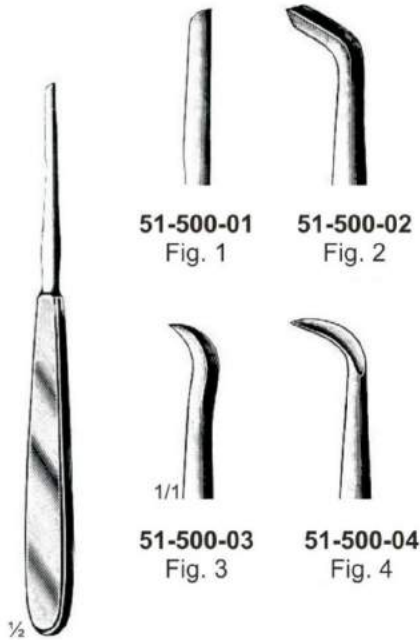

Chompert  
51-500-01 - 51-500-04

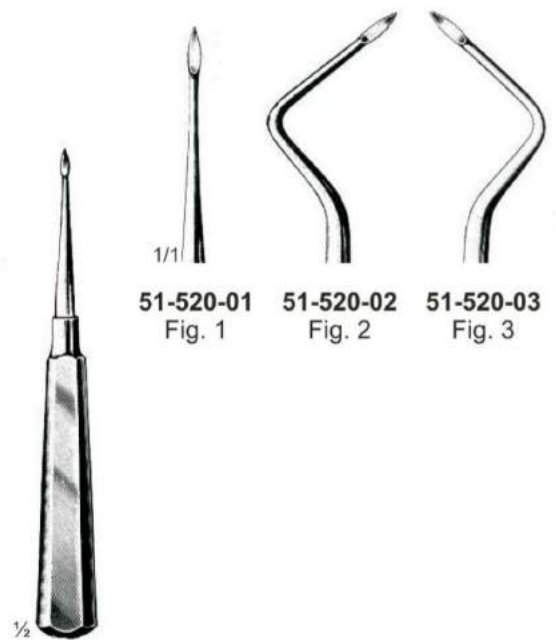

Heidebrink  
51-520-01 - 51-520-03

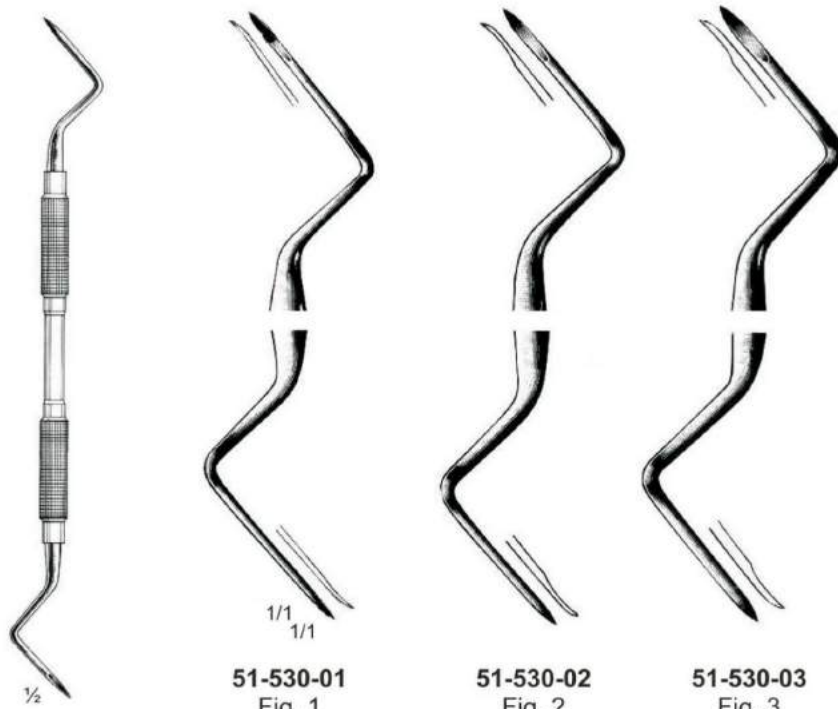

Heidebrink  
51-530-01 - 51-530-03

**Extraction - Extraktion - Extracción**  
**Root Elevators**  
**Wurzelheber**  
**Elevadores para raíces**



West  
 51-550-23  
 Fig. 2/3



West  
 51-550-56  
 Fig. 5/6



Walter F. Barry  
 51-560-04 - 51-560-06

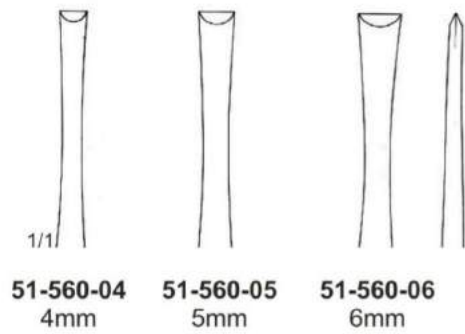

**Extraction - Extraktion - Extracción  
Cartridge Syringes  
Ampullenspritzen  
Jeringas para cartucho-ampollas**



51-600-01



51-604-01



51-606-01



51-608-01

Extraction - Extraktion - Extracción  
Water Syringes  
Wasserspritzen  
Jeringas para agua



½

51-700-00



51-700-01



51-710-05

51-700-00 Al-metal water syringe, self filling

51-700-01 Cannula luer lock, only

**Extraction - Extraktion - Extracción**  
**Mouth Mirrors**  
**Mundspiegel**  
**Espejos de boca**

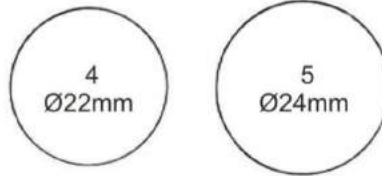

Plane, simple thread  
**51-800-22** Fig. 4 Ø22mm  
**51-800-24** Fig. 5 Ø24mm



Magnifying, simple thread  
**51-802-22** Fig. 4 Ø22mm  
**51-802-24** Fig. 5 Ø24mm



Plane, Cone-Socket  
**51-806-22** Fig. 4 Ø22mm  
**51-806-24** Fig. 5 Ø24mm



Magnifying, Cone-Socket  
**51-808-22** Fig. 4 Ø22mm  
**51-808-24** Fig. 5 Ø24mm

Extraction - Extraktion - Extracción  
Cheek Holder  
Abhalter  
Saparador



1/1

Holder with welded-on handle  
Hilger  
**51-820-18**  
18 cm



1/1

Handle Only  
**51-824-14**  
14 cm



1/1

Holder only  
Hilger  
**51-830-04**  
4.5 cm

**Extraction - Extraktion - Extracción**  
**Handles for Mouth Mirrors**  
**Mundspiegelgriffe**  
**Mangos para espejos de boca**

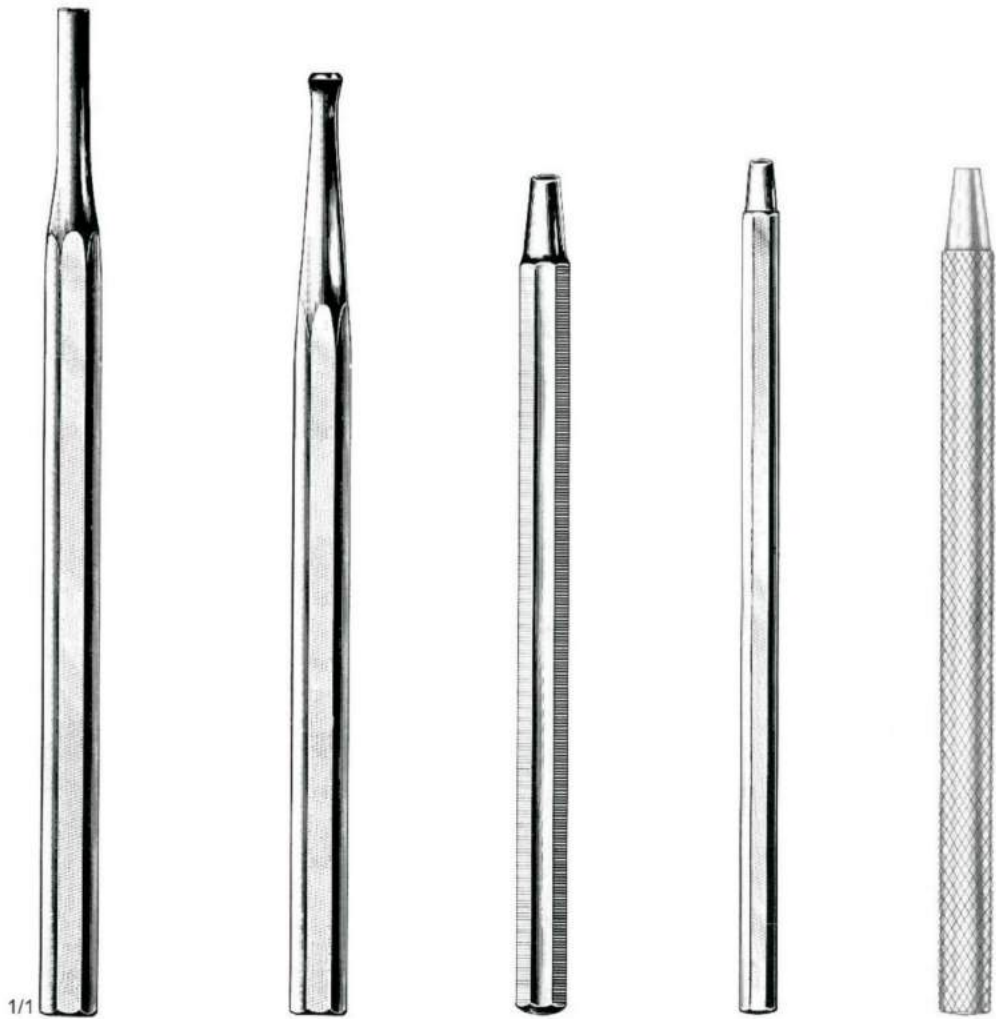

1/1  
**51-850-01 - 51-850-02**

Secco  
**51-854-01**

**51-858-01**

**51-862-01**

**51-866-01**

**51-858-01** with simple thread  
**51-858-02** with Cone-Socket





**Surgery - Chirurgie - Cirugía**  
**Scapel Handles**  
**Skalpelli - Griffe**  
**Mangos de bisturíes**

For Fig. 18 - 36

For Fig. 10 - 17



1/1

**Standard**  
**04-150-03**  
12cm  
No. 3



1/1

**Standard**  
**04-170-04**  
12cm  
No. 4

For Fig. 10 - 17



1/1

**04-200-71**  
12.5cm  
No. 7K

**Surgery - Chirurgie - Cirugía**  
**Operating Scissors**  
**Chirurgische Scheren**  
**Tijeras para cirugía**



Standard  
**05-100-13 - 05-100-14**

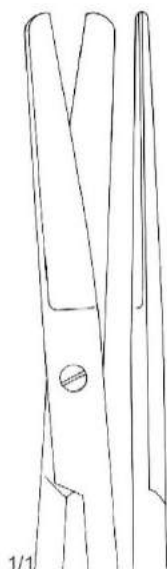

**05-100-13**  
 13.0 cm

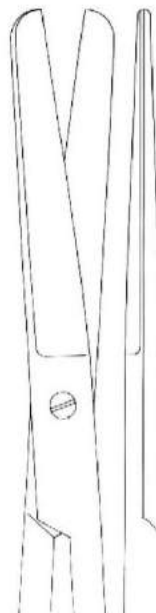

**05-100-14**  
 14.5 cm

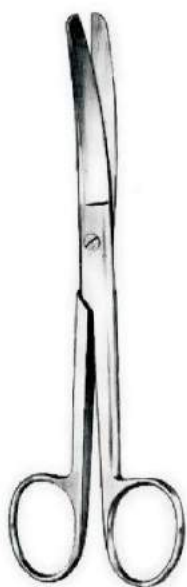

Standard  
**05-101-13 - 05-101-14**

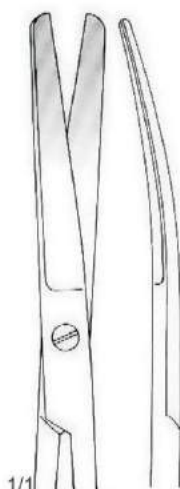

**05-101-13**  
 13.0 cm

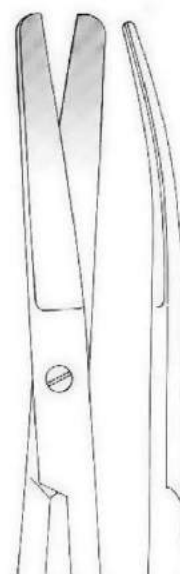

**05-101-14**  
 14.5 cm

**Surgery - Chirurgie - Cirugía**  
**Operating Scissors**  
**Chirurgische Scheren**  
**Tijeras para cirugía**

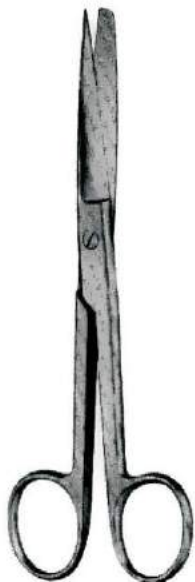

Standard  
**05-102-13 - 05-102-14**

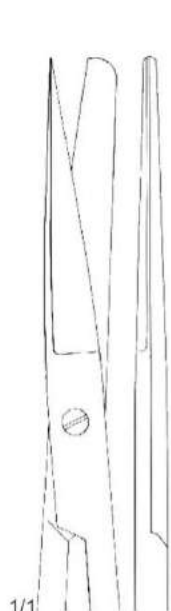

**05-102-13**  
 13.0 cm

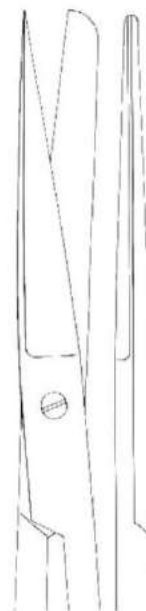

**05-100-14**  
 14.5 cm

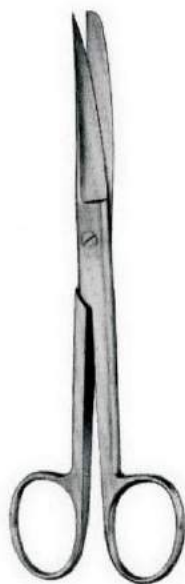

Standard  
**05-103-13 - 05-102-14**



**05-103-13**  
 13.0 cm

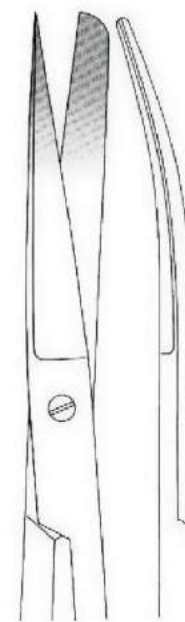

**05-103-14**  
 14.5 cm

**Surgery - Chirurgie - Cirugía**  
**Operating Scissors**  
**Chirurgische Scheren**  
**Tijeras para cirugía**

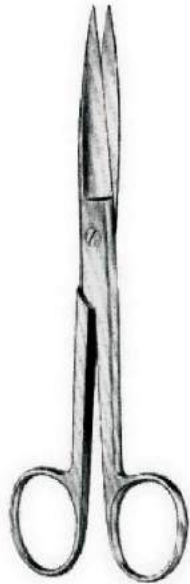

Standard  
**05-104-13 - 05-104-14**

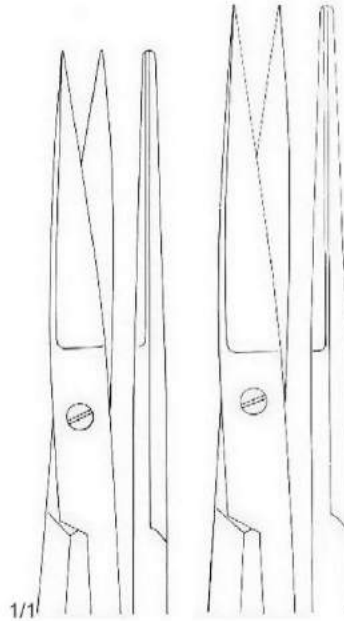

**05-104-13**  
 13.0 cm

**05-104-14**  
 14.5 cm

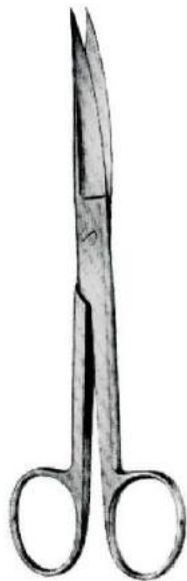

Standard  
**05-105-13 - 05-105-14**

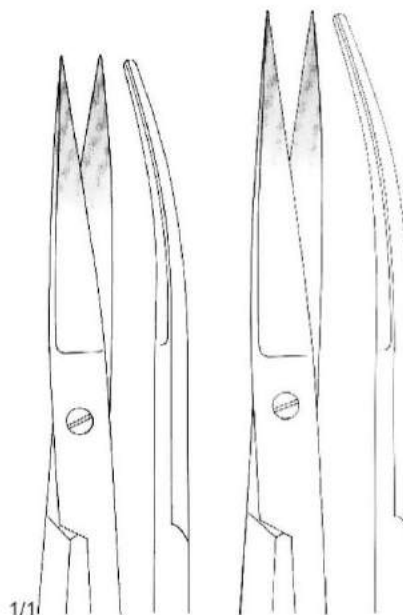

**05-105-13**  
 13.0 cm

**05-105-14**  
 14.5 cm



**Surgery - Chirurgie - Cirugía**  
**Operating Scissors**  
**Chirurgische Scheren**  
**Tijeras para cirugía**



Standard TC  
**05-900-14** Straight 14.5cm  
**05-901-14** Curved 14.5cm



Standard TC  
**05-902-14** Straight 14.5cm  
**05-903-14** Curved 14.5cm



Standard TC  
**05-904-14** Straight 14.5cm  
**05-905-14** Curved 14.5cm



**Surgery - Chirurgie - Cirugia**  
**Operating Scissors**  
**Chirurgische Scheren**  
**Tijeras para cirugía**



Metzenbaum  
**05-220-15 - 05-221-18**



**05-220-15**  
 15cm

**05-220-18**  
 18cm



**05-221-15**  
 15cm

**05-221-18**  
 18cm



Metzenbaum TC  
**05-920-15 - 05-921-18**



**05-920-15**  
 15cm

**05-920-18**  
 18cm



**05-921-15**  
 15cm

**05-921-18**  
 18cm

Surgery - Chirurgie - Cirugía  
Operating Scissors  
Chirurgische Scheren  
Tijeras para cirugía

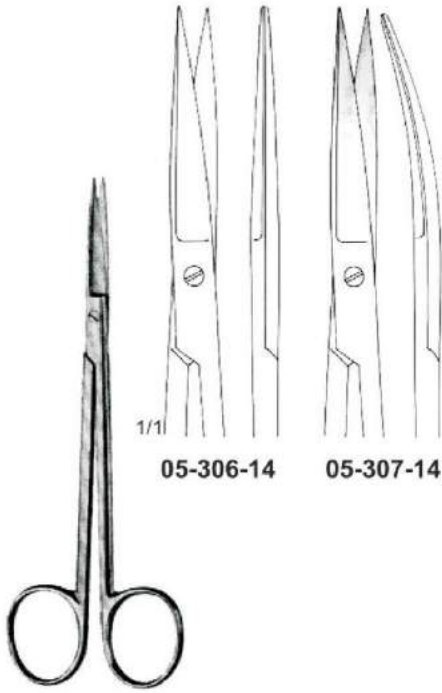

Joseph  
05-306-14 - 05-307-14  
14cm

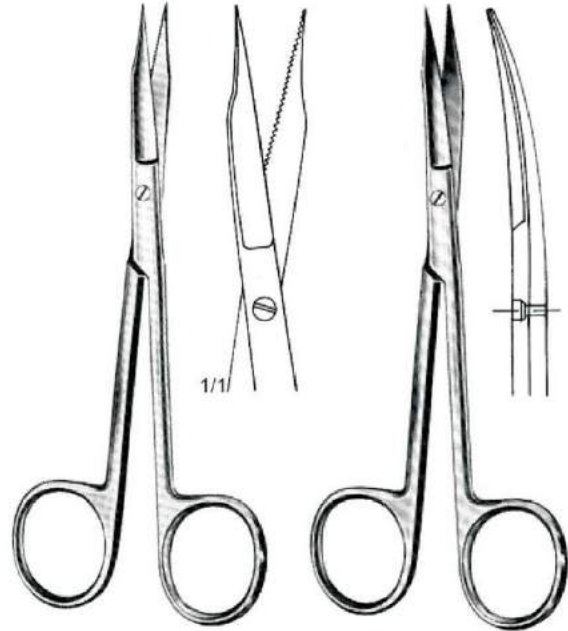

Goldman - Fox  
05-530-13  
13cm

Goldman - Fox  
05-531-13  
13cm

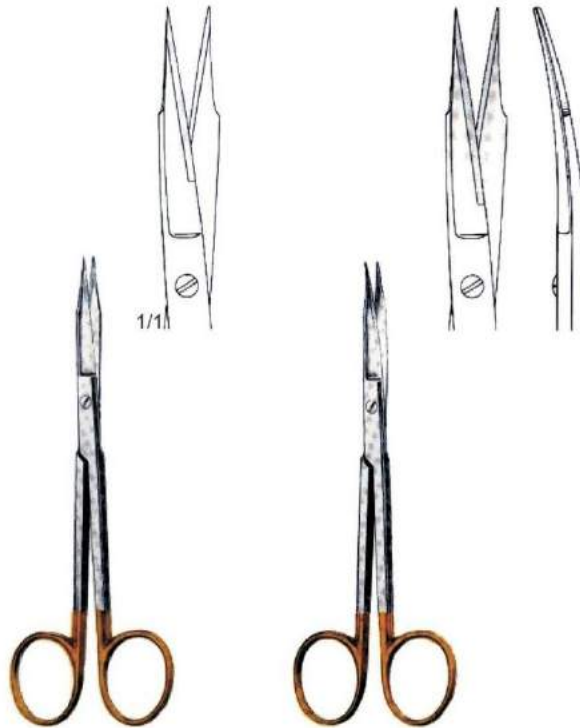

Goldman - Fox TC  
05-950-13  
13cm

Goldman - Fox TC  
05-951-13  
13cm

**Surgery - Chirurgie - Cirugía**  
**Operating Scissors**  
**Chirurgische Scheren**  
**Tijeras para cirugía**

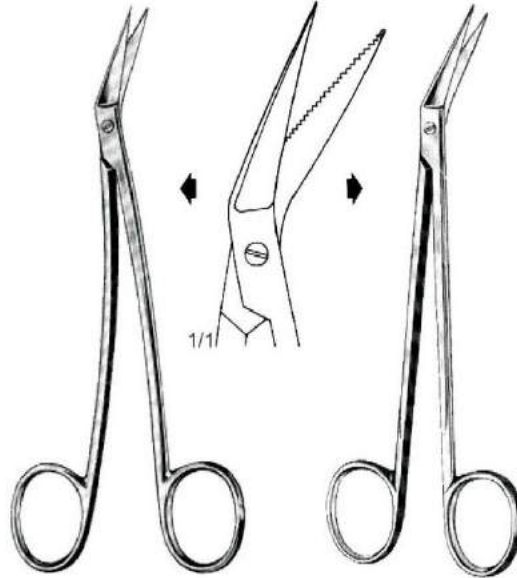

Locklin  
**05-538-16**  
 16.5cm

Locklin  
**05-539-16**  
 16.5cm

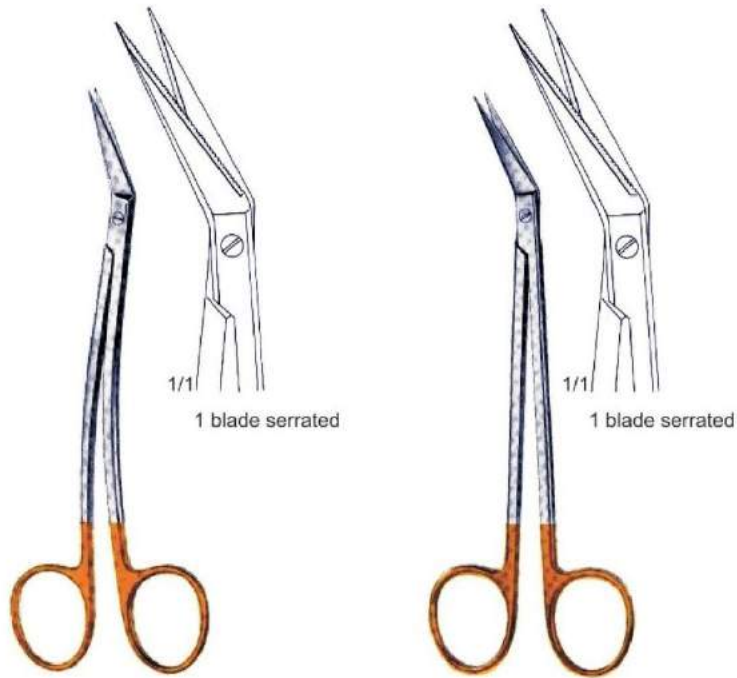

Locklin TC  
**05-977-16**  
 16cm

Locklin TC  
**05-978-16**  
 16cm





**Surgery - Chirurgie - Cirugía**  
**Operating Scissors**  
**Chirurgische Scheren**  
**Tijeras para cirugía**



Wagner  
05-550-12- 05-555-12  
12cm



05-550-12



05-552-12



05-554-12



05-551-12



05-553-12



05-555-12



**Surgery - Chirurgie - Cirugía**  
**Operating Scissors**  
**Chirurgische Scheren**  
**Tijeras para cirugía**

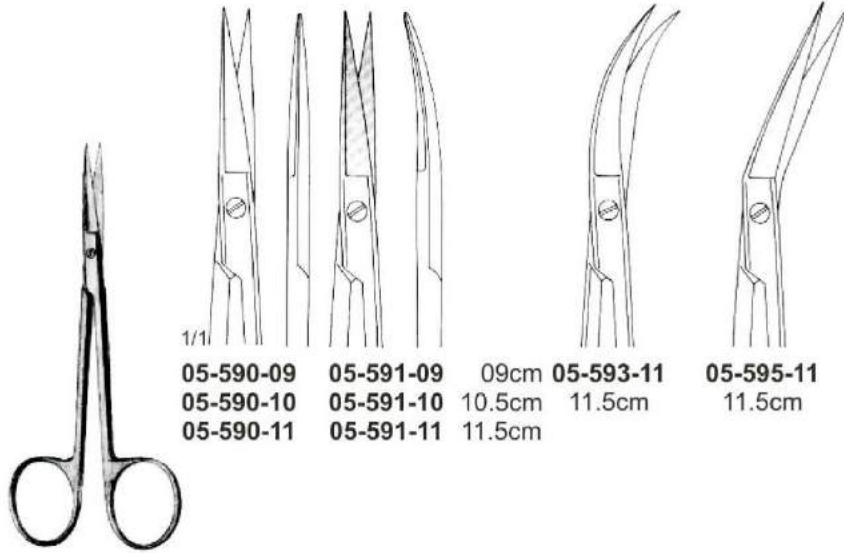

1/1

|                  |                  |        |                  |                  |
|------------------|------------------|--------|------------------|------------------|
| <b>05-590-09</b> | <b>05-591-09</b> | 09cm   | <b>05-593-11</b> | <b>05-595-11</b> |
| <b>05-590-10</b> | <b>05-591-10</b> | 10.5cm | 11.5cm           | 11.5cm           |
| <b>05-590-11</b> | <b>05-591-11</b> | 11.5cm |                  |                  |

Iris  
**05-590-09 - 05-591-11**

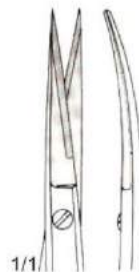

Iris TC  
**05-954-11**  
11.5cm



Iris TC  
**05-955-11**  
11.5cm

**Surgery - Chirurgie - Cirugía**  
**Operating Scissors**  
**Chirurgische Scheren**  
**Tijeras para cirugía**



La Grange  
**05-658-11**  
 11.5cm

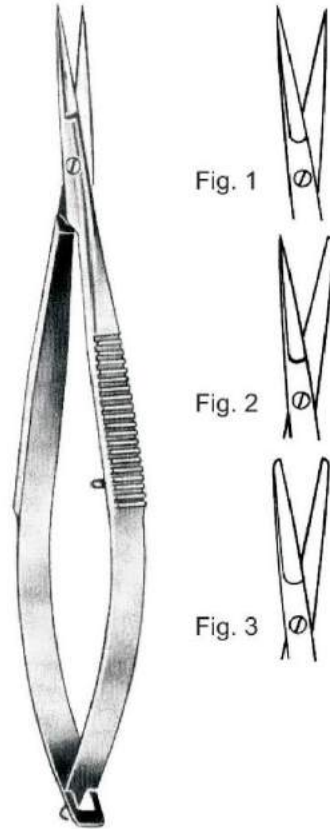

Noyes  
**05-680-12** Fig. 1  
**05-682-12** Fig. 2  
**05-684-12** Fig. 3  
 12cm



**05-758-11**  
 11cm



**05-759-11**  
 11cm



Spencer  
**05-762-09** 09cm  
**05-762-11** 11cm



**Surgery - Chirurgie - Cirugía**  
**Operating Scissors**  
**Chirurgische Scheren**  
**Tijeras para cirugía**



**Universal**  
**05-954-11**  
 11.5cm

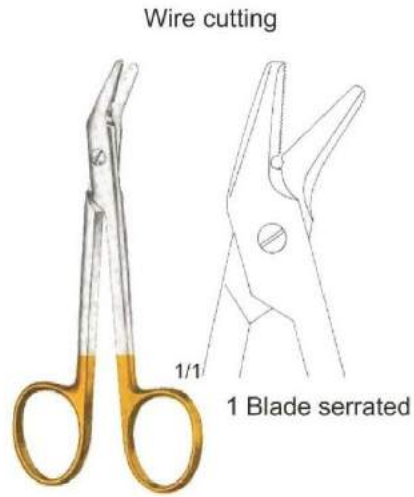

**Universal TC**  
**05-974-12**  
 12cm

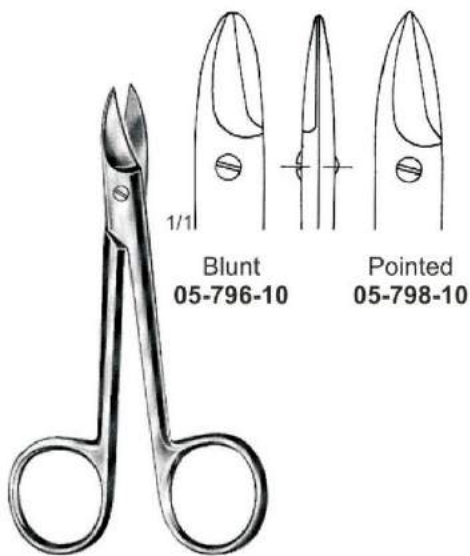

**Bee Bee**  
 10.5cm

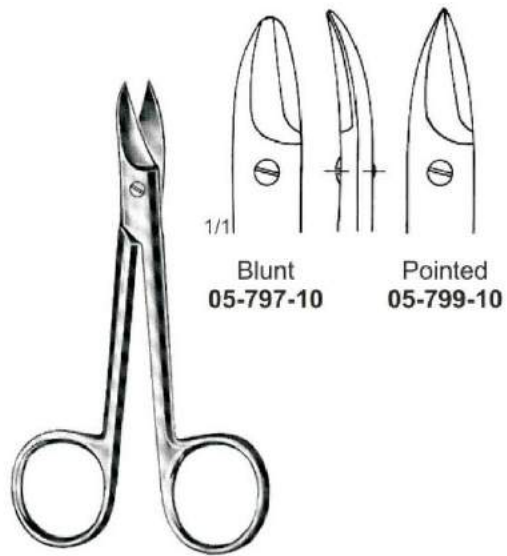

**Bee Bee**  
 10.5cm

Surgery - Chirurgie - Cirugía  
Dressing Forceps  
Anatomische Pinzetten  
Pinzas de disección



**06-100-13**  
13cm



**06-100-14**  
14.5cm

Standard  
**06-100-13 - 06-100-14**



**06-250-13**  
13cm



**06-250-14**  
14.5cm

Standard  
**06-250-13 - 06-250-14**  
1:2 Teeth

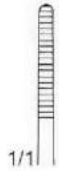

**06-110-13**  
13cm



**06-110-14**  
14.5cm

Narrow  
**06-110-13 - 06-110-14**



**06-260-13**  
13cm



**06-260-14**  
14.5cm

Narrow  
**06-260-13 - 06-260-14**  
1:2 Teeth



**Surgery - Chirurgie - Cirugía**  
**Dressing Forceps**  
**Anatomische Pinzetten**  
**Pinzas de disección**



Adson  
**06-132-12**  
12cm

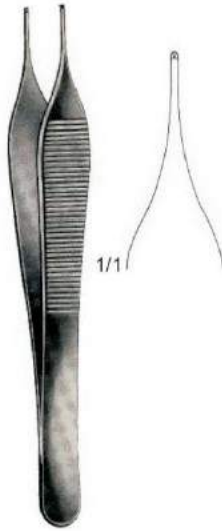

Adson  
**06-270-12**  
12cm  
1:2 Teeth



Adson TC  
**06-726-12**  
12cm  
Normal Profile



Semken  
**06-150-12** 12cm  
**06-150-15** 15cm



Semken  
**06-328-12** 12cm  
**06-328-15** 15cm



Taylor  
**06-164-17**  
17cm



Taylor  
**06-332-12**  
17cm  
1:2 Teeth



**Surgery - Chirurgie - Cirugía**  
**Dressing Forceps**  
**Anatomische Pinzetten**  
**Pinzas de disección**



Cushing  
**06-180-17**  
17.5cm



Cushing  
**06-180-17**  
17.5cm  
1:2 Teeth



Cushing TC  
**06-732-17**  
17.5cm  
Normal Profile  
With dissector end

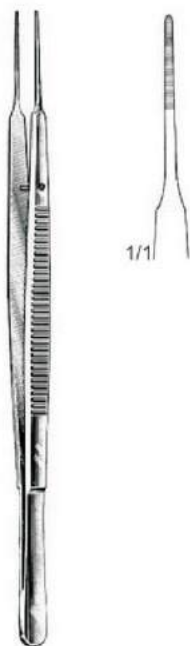

Gerald  
**06-176-18**  
18cm



Gerald  
**06-340-18**  
18cm

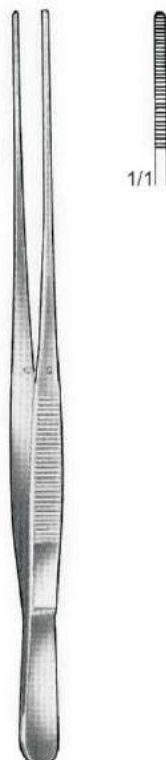

Brophy  
**06-190-20**  
20cm

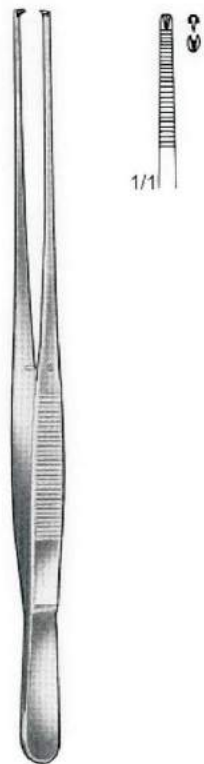

Brophy  
**06-356-20**  
20cm



**Surgery - Chirurgie - Cirugia**  
**Splinter Forceps**  
**Splitterzangen**  
**Pinzas para espinas**

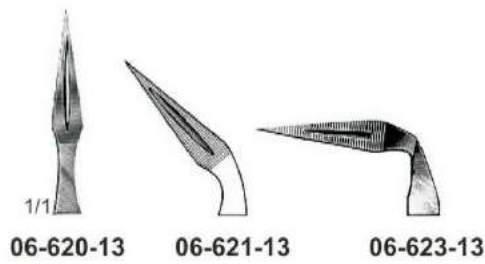

06-620-13

06-621-13

06-623-13

Srieglitz  
06-620-13 - 06-623-13  
13.5cm



Peet  
06-625-11  
11.5cm

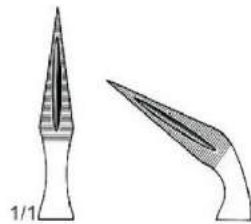

06-628-15

06-629-15

Ralk  
06-628-15 - 06-629-15  
15cm

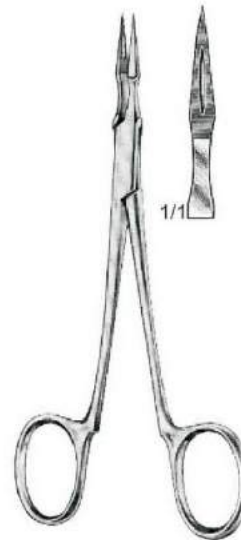

Arthur  
06-632-14  
14cm



**Surgery - Chirurgie - Cirugía**  
**Artery Forceps**  
**Arterienklemmen**  
**Pinzas hemostáticas**

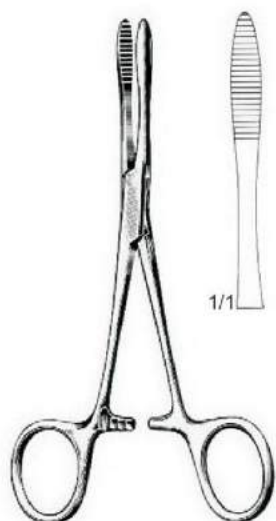

Pean  
**07-170-14**  
 14cm

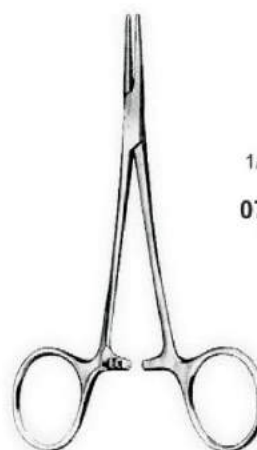

Halstead-Mosquito  
**07-190-12 - 07-191-12**  
 12.5cm

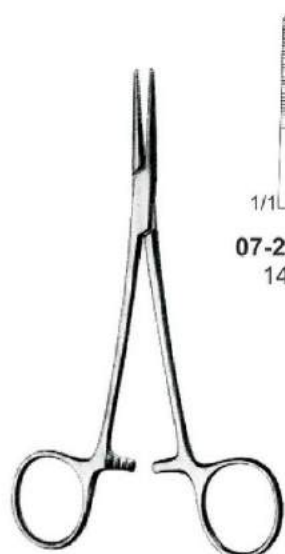
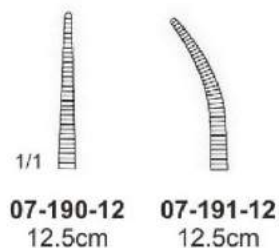

Providence-Hospital  
**07-220-14 - 07-221-14**  
 14cm

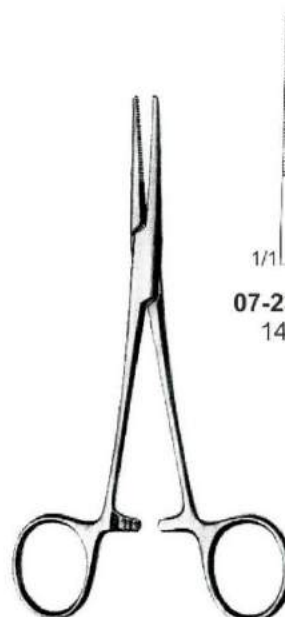
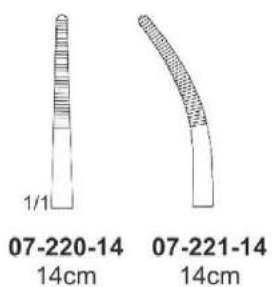

Kelly  
**07-230-14 - 07-231-14**  
 14cm

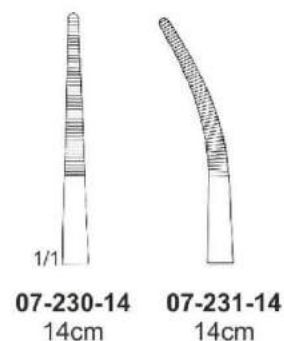

**Surgery - Chirurgie - Cirugía**  
**Artery Forceps**  
**Arterienklemmen**  
**Pinzas hemostáticas**

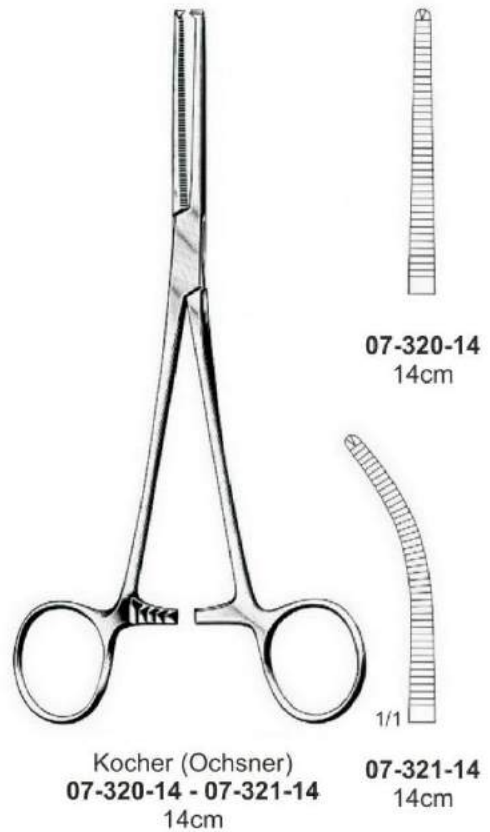
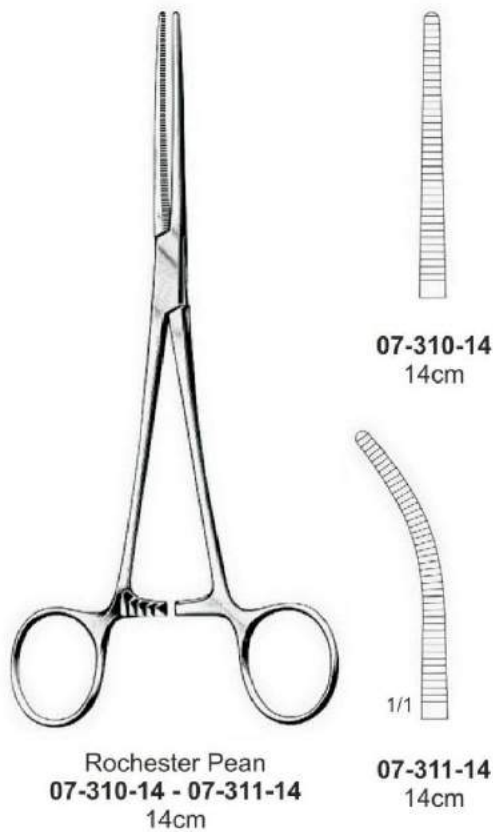
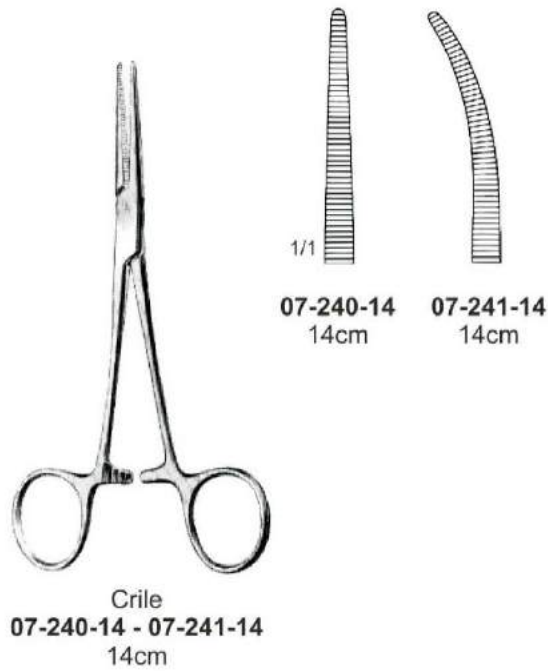



**Surgery - Chirurgie - Cirugía**  
**Towel Forceps**  
**Tuchklemmen**  
**Pinzas para compresas, Pinzas de campo**



**Schaedel**  
**07-671-09**  
09cm

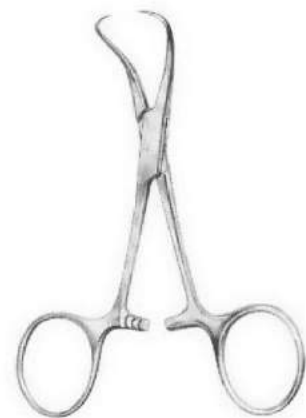

**Backhaus**  
**07-681-09** 09cm  
**07-681-11** 11cm



**Surgery - Chirurgie - Cirugía**  
**Dressing Forceps**  
**Tupferzangen**  
**Pinzas para tapones**

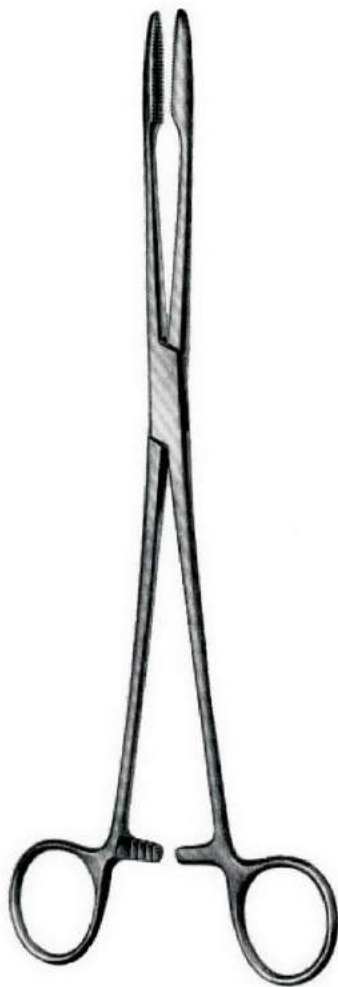

Gross-Maier  
**08-150-20 - 08-151-20**  
20cm



1/1  
**08-150-20**  
20cm



**08-151-20**  
20cm



Surgery - Chirurgie - Cirugia  
Retractors  
Wundhaken  
Separadores

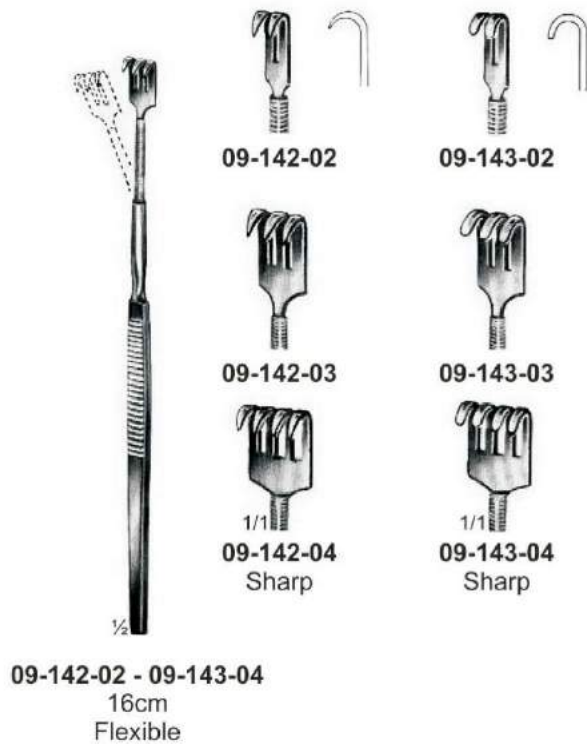
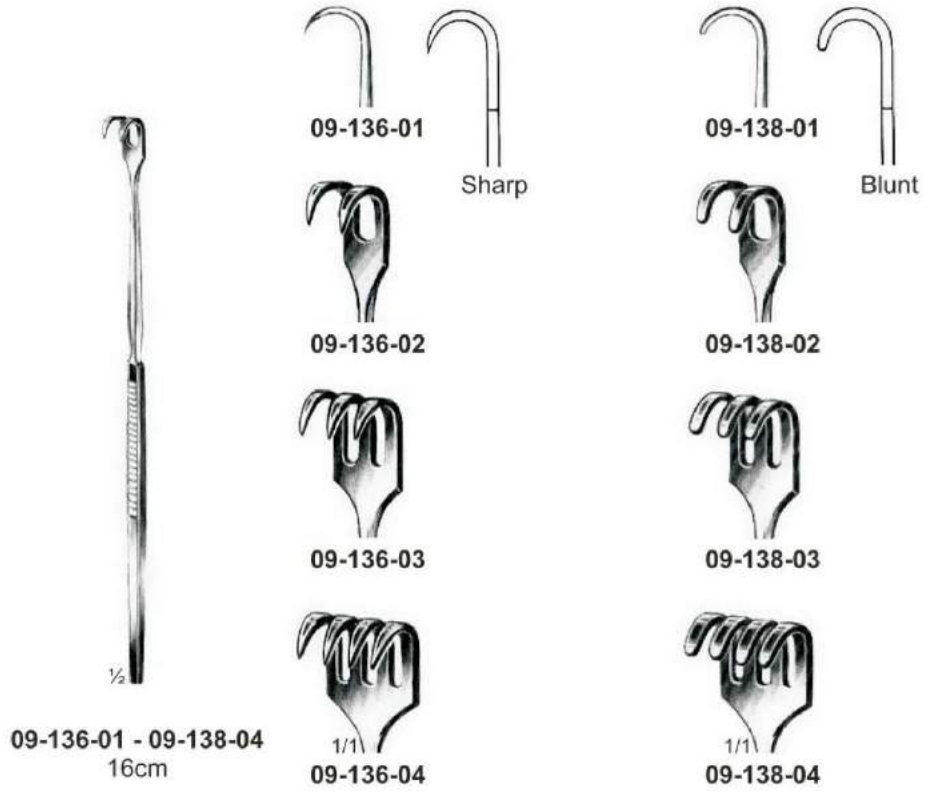

**Surgery - Chirurgie - Cirugía**  
**Retractors**  
**Wundhaken**  
**Separadores**



Senn-Miller  
**09-186-16 - 09-187-16**  
 16cm

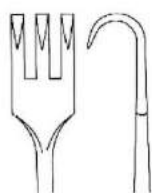

1/1

**09-186-16**  
 7 x 8.5mm  
 Sharp

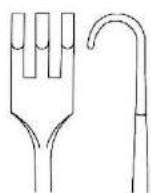

**09-187-16**  
 7 x 8.5mm  
 Blunt



Langenbeck  
**09-281-01 - 09-281-04**  
 22cm



**09-281-01**  
 30 x 11mm



**09-281-02**  
 30 x 14mm



**09-281-03**  
 30 x 16mm



**09-281-04**  
 40 x 11mm

1/1

**Surgery - Chirurgie - Cirugía**  
**Retractors**  
**Wundhaken**  
**Separadores**



Kocher-Langenbeck  
**09-297-05 - 09-297-06**  
 22cm

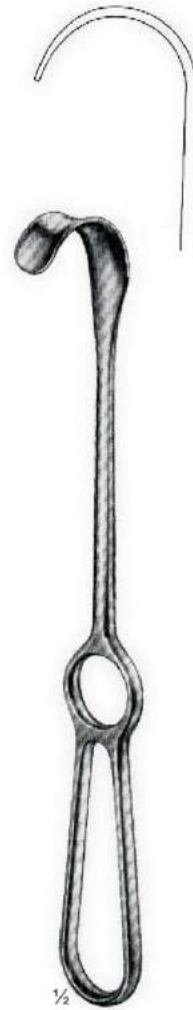
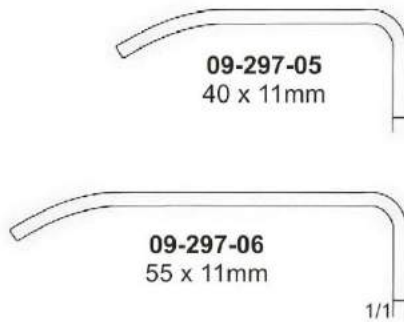

Middeldorpf  
**09-311-01 - 09-311-02**





**Surgery - Chirurgie - Cirugía**  
**Retractors**  
**Wundhaken**  
**Separadores**

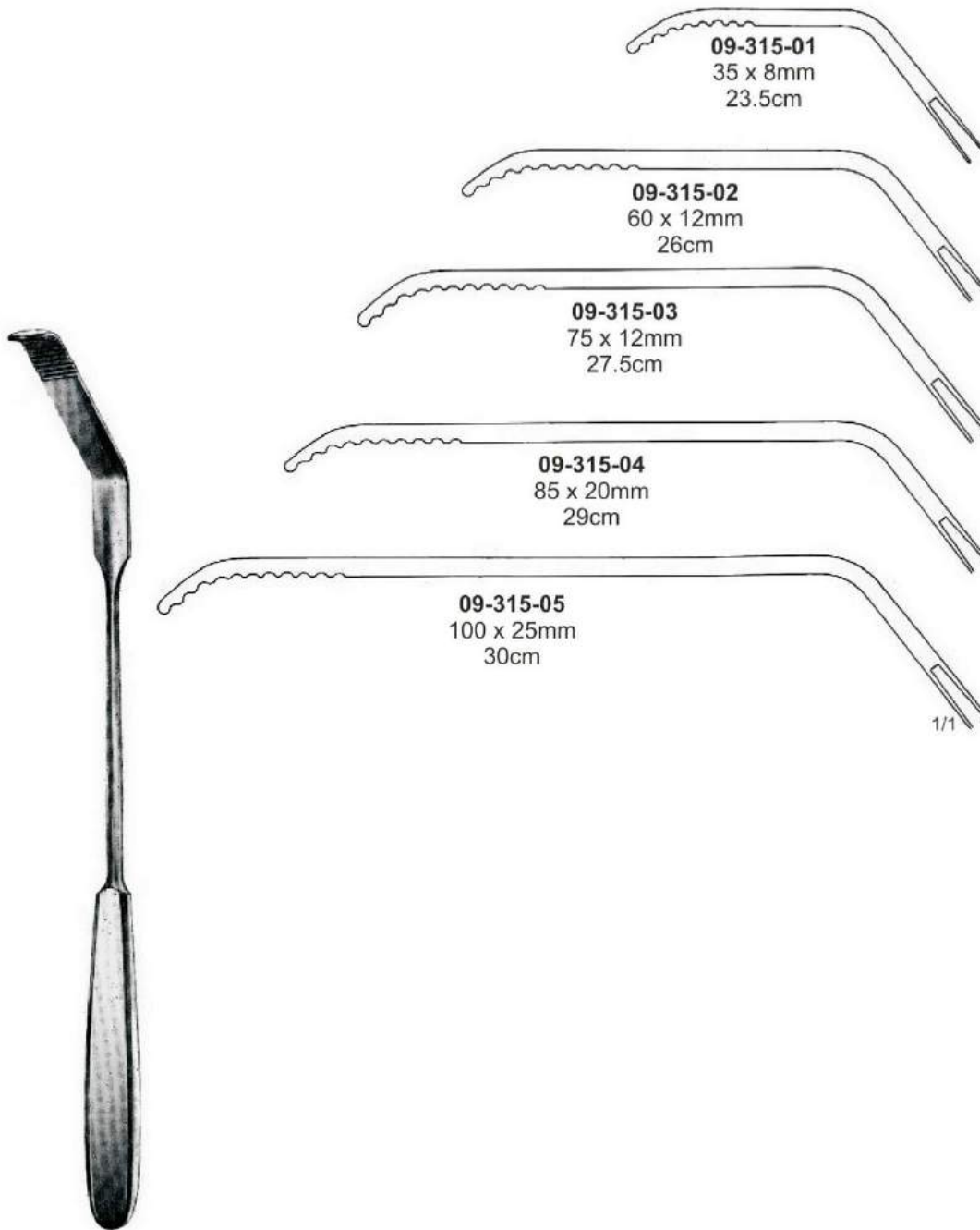

Zenker  
09-315-01 - 09-315-05



**Surgery - Chirurgie - Cirugia**  
**Retractors**  
**Wundhaken**  
**Separadores**



Roux  
**09-561-01** Fig. 1 15cm  
**09-561-02** Fig. 2 16cm  
**09-561-03** Fig. 3 17cm

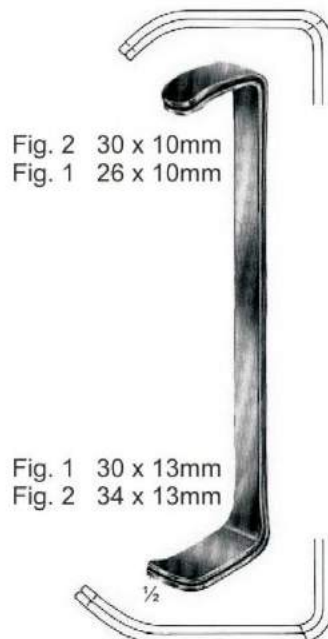
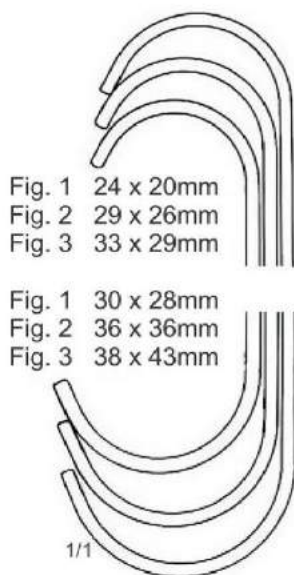

Farabeuf  
**09-573-00** Set  
 12cm

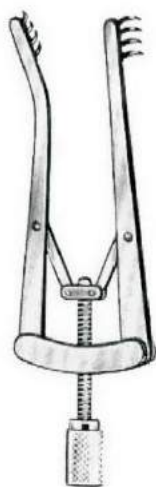

Alm  
**09-612-07** 7cm Sharp  
**09-612-10** 10cm Sharp  
 4 x 4 Teeth



Weitlaner-Wullstein  
**09-664-13 - 09-665-13**  
 13cm

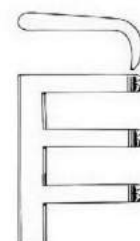

**09-664-13**  
 Sharp  
 3 x 3 teeth

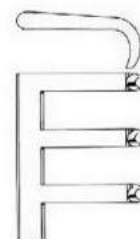

**09-665-13**  
 Blunt  
 3 x 3 teeth



Surgery - Chirurgie - Cirugia  
Needle Holders  
Nadelhalter  
Porta - agujas

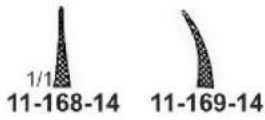
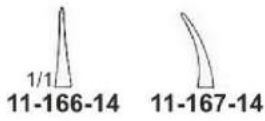
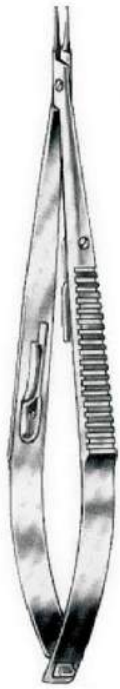

Castroviejo  
11-166-14 - 11-169-14  
14cm

Castroviejo TC  
11-514-14 - 11-515-14  
14cm

Stevens  
11-218-13 13cm  
11-218-15 15cm

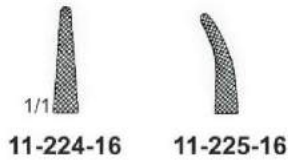

Arruga  
11-224-16 - 11-225-16  
16cm

Arruga TC  
11-526-16 - 11-527-16  
16cm

**Surgery - Chirurgie - Cirugía**  
**Needle Holders**  
**Nadelhalter**  
**Porta - agujas**



Halsey  
**11-260-13**  
 13cm



Halsey TC  
**11-540-13**  
 13cm

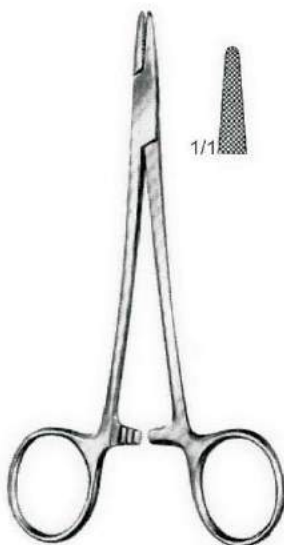

Hegar-Baumgartner  
**11-264-13** 13cm  
**11-264-14** 14cm



Hegar-Baumgartner TC  
**11-548-13** 13cm  
**11-548-14** 14cm

**Surgery - Chirurgie - Cirugia**  
**Needle Holders**  
**Nadelhalter**  
**Porta - agujas**



**Crile-Murray**  
**11-290-15**  
 15cm

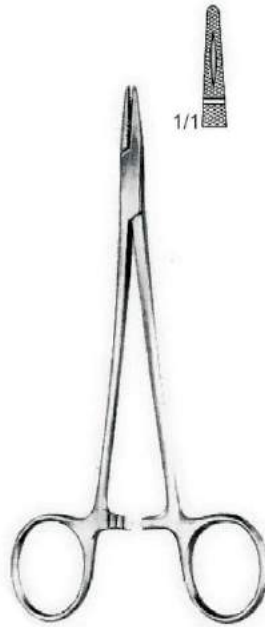

**Crile-Wood**  
**11-292-15**  
 15cm



**Crile-Wood TC**  
**11-604-15**  
 15cm

Mini profile



**Mayo-Hegar**  
**11-314-16 - 11-314-18**

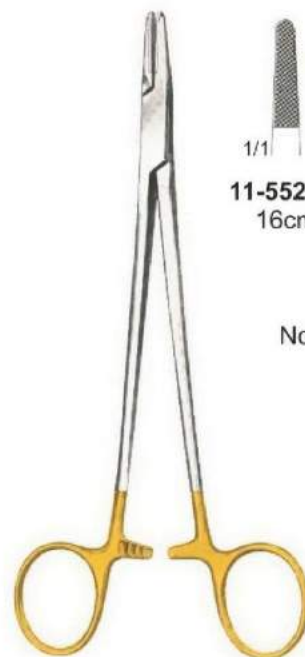
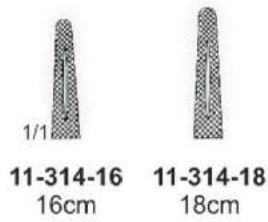

**Mayo-Hegar TC**  
**11-552-16 - 11-552-18**

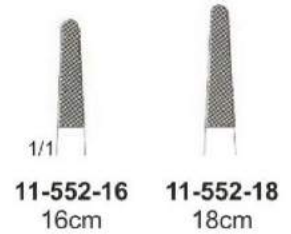

Normal profile

**Surgery - Chirurgie - Cirugía**  
**Needle Holders**  
**Nadelhalter**  
**Porta - agujas**

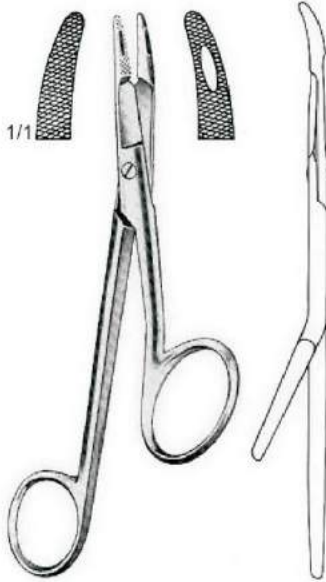

**Gillies**  
**11-361-16**  
 16cm

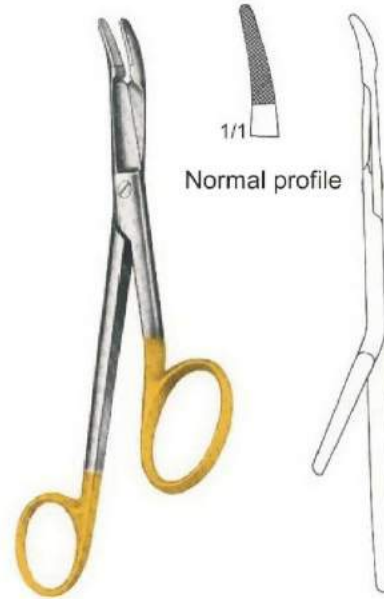

**Gillies TC**  
**11-615-16**  
 16cm

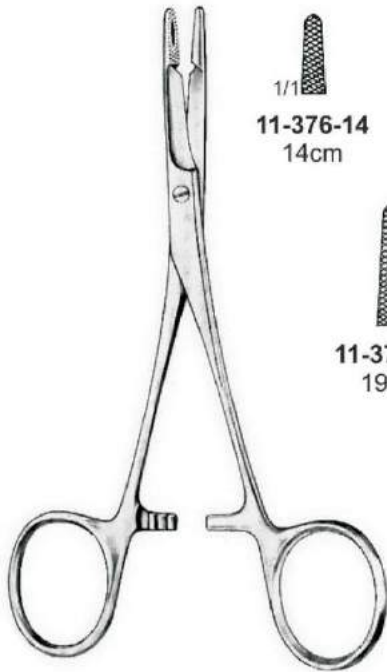

**Olsen-Hegar**  
**11-376-14 - 11-376-19**

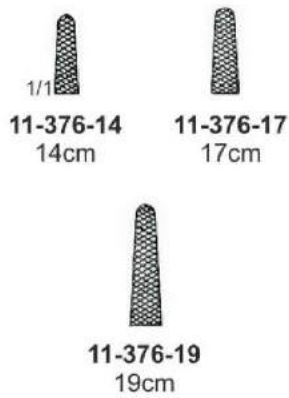

**Olsen-Hegar TC**  
**11-610-14 - 11-610-18**



Normal profile



**Surgery - Chirurgie - Cirugía**  
**Needle Holders**  
**Nadelhalter**  
**Porta - agujas**



Mathieu  
11-390-14 - 11-390-24



11-390-14  
14cm



11-390-17  
17cm



11-390-20  
20cm



11-390-24  
24cm



Mathieu-Delicate  
11-394-14 - 11-394-17



11-394-14  
14cm



11-394-17  
17cm



**Surgery - Chirurgie - Cirugía**  
**Needle Holders**  
**Nadelhalter**  
**Porta - agujas**



Mathieu-Delicate  
 11-634-14 - 11-634-20

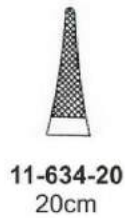
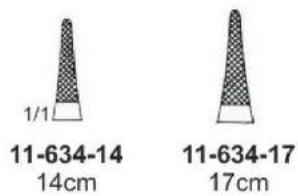

Normal profile



Mathieu  
 11-630-14 - 11-630-24

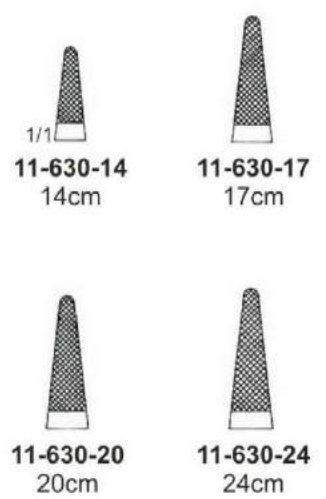

Normal profile



**Surgery - Chirurgie - Cirugía**  
**Needle Holders**  
**Nadelhalter**  
**Porta - agujas**



Eiselsberg-Mathieu  
**11-403-18**  
18.5cm

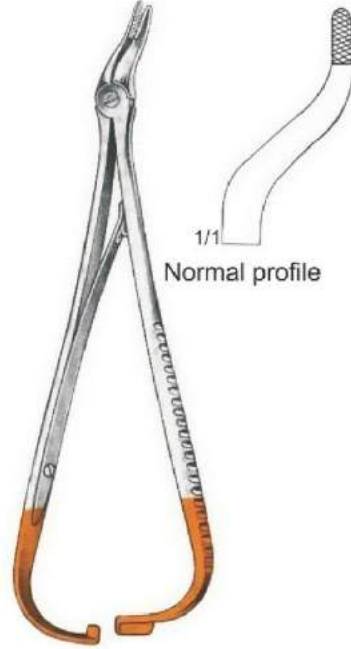

Eiselsberg-Mathieu TC  
**11-663-18**  
18cm



Toennis  
**11-410-18**  
18cm



Toennis TC  
**11-652-18**  
18cm



**Surgery - Chirurgie - Cirugía  
Bone Chisels and Gouges  
Meißel und Osteotome  
Cinceles y Gubias para huesos**

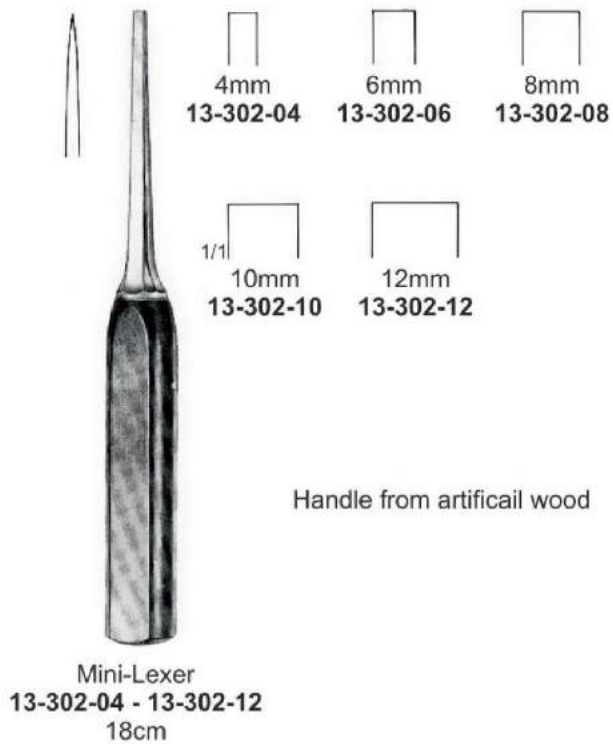
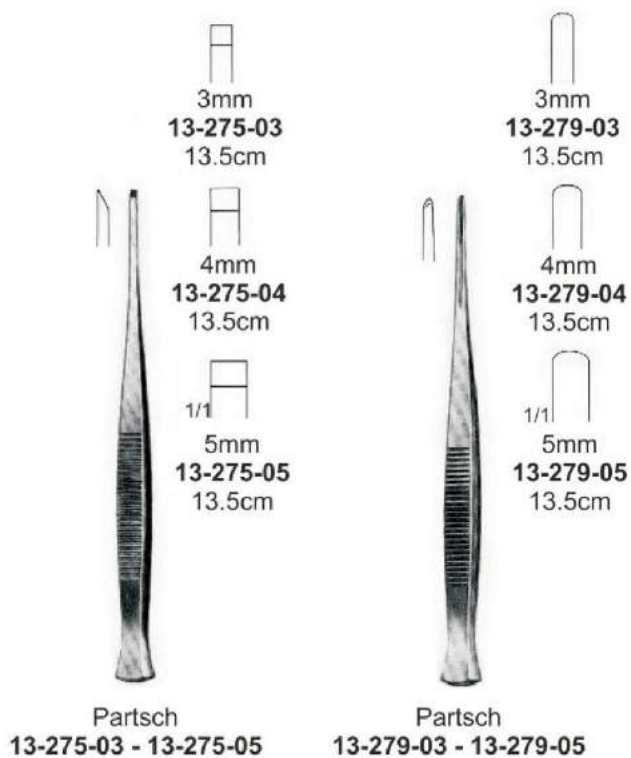



**Surgery - Chirurgie - Cirugía**  
**Mallets**  
**Hämmer**  
**Martillos y Mazos**

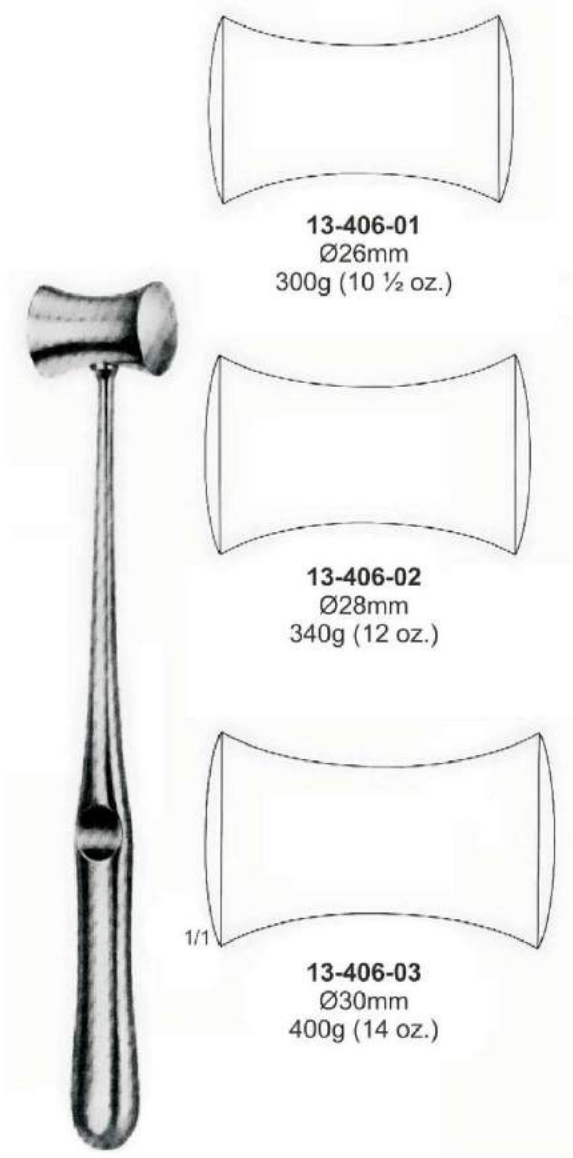

Williger  
**13-406-01 - 13-406-03**  
 24cm

(Lead filled)

With interchangeable  
 Perrozell faces

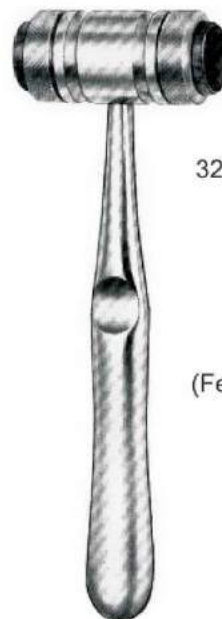

Ø26mm  
 320g (11 ½ oz.)

**13-450-17**  
 (solid)  
**13-451-17**  
 (Ferrozell Faces)

Mead  
**13-450-17 - 13-451-17**  
 17cm



**Surgery - Chirurgie - Cirugia**  
**Bone Currettes**  
**Scharfe Löffel**  
**Cucharillas cortantes**

Fig. 0000  
13-502-40

Fig. 000  
13-502-30

Fig. 00  
13-502-20

Fig. 0  
13-502-10

Fig. 1  
13-503-01

Fig. 2  
13-503-02

Fig. 3  
13-503-03

Fig. 4  
13-503-04

Fig. 5  
13-503-05

1/1  
Fig. 6  
13-503-06



Volkman  
13-502-10 - 13-503-06  
17cm



Fig. 00 - 0  
13-550-00

Fig. 0 - 1  
13-550-01

1/1  
Fig. 1 - 2  
13-550-12

Williger  
13-550-00 - 13-550-12  
13.5cm



13-552-00

13-552-01

13-552-12

Martini  
13-552-00 - 13-552-12  
13.5cm

**Surgery - Chirurgie - Cirugía**  
**Bone Currettes**  
**Scharfe Löffel**  
**Cucharillas cortantes**

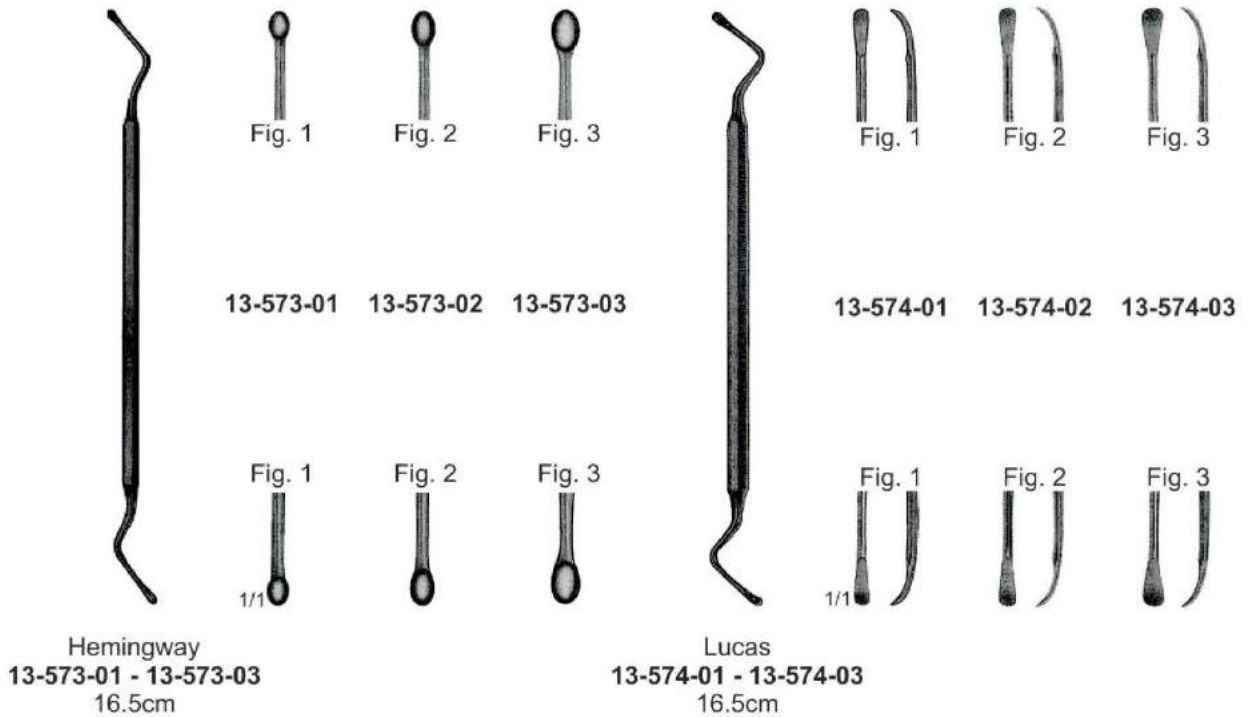
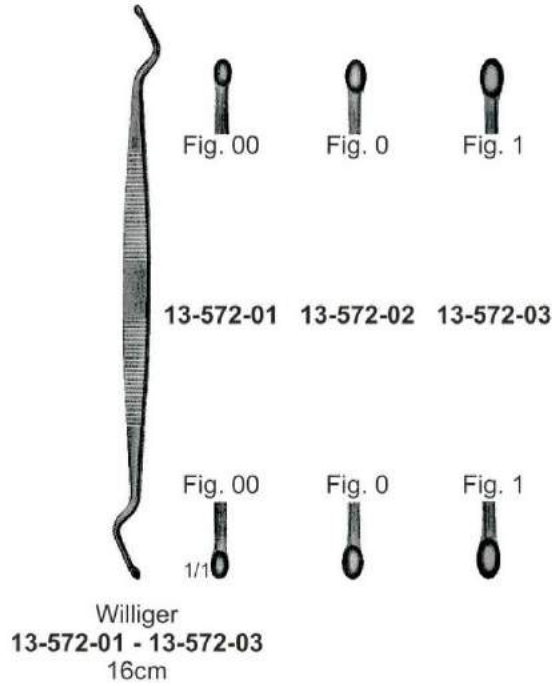

**Surgery - Chirurgie - Cirugía**  
**Bone Holding Forceps**  
**Knochenhaltezaugen**  
**Pinzas para huesos**



1/1  
Dingmann  
13-785-19

Dingmann Mod.  
13-787-19

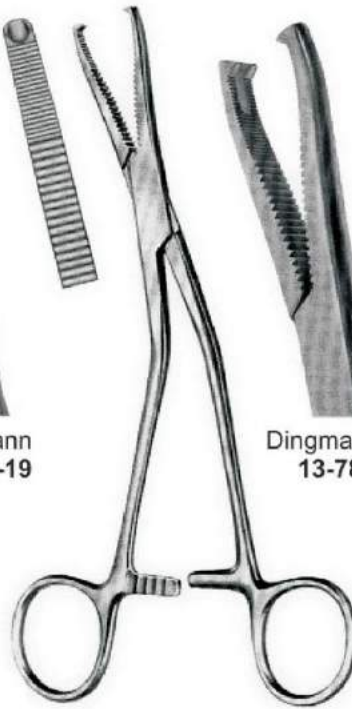

13-785-19 - 13-787-19



13-801-13  
13.5cm

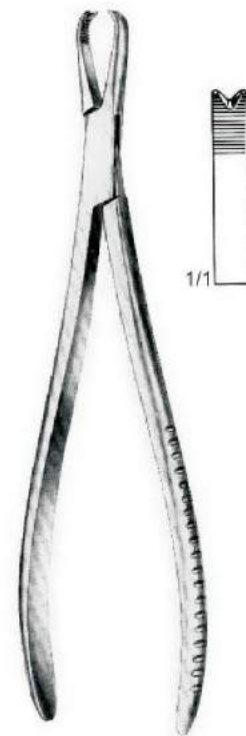

13-808-20  
20cm

**Surgery - Chirurgie - Cirugia**  
**Bone Rongeur Forceps**  
**Hohlmeißelzangen**  
**Pinzas-gubias**



Mini-Friedman  
**13-843-12**  
 12cm



Friedman  
**13-845-14**  
 14cm

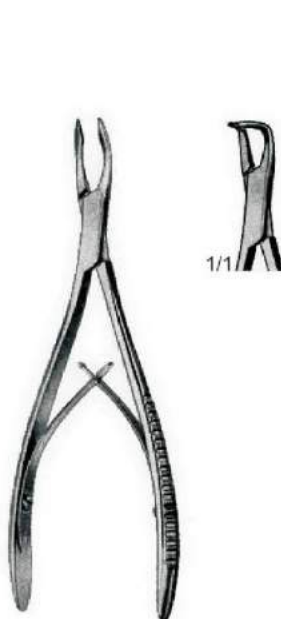

Mini-Friedman  
**13-846-01**  
 15cm



Friedman-Vickers  
**13-847-14**  
 14cm

**Surgery - Chirurgie - Cirugía**  
**Bone Rongeur Forceps**  
**Hohlmeißelzangen**  
**Pinzas-gubias**



**Cleveland**  
**13-851-14**  
 14cm

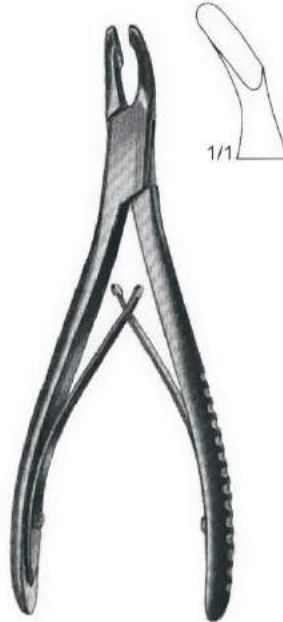

**Cleveland**  
**13-853-17**  
 17cm

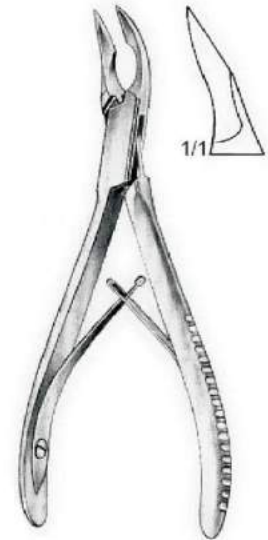

**Cleveland**  
**13-951-15**  
 15cm



**Mead**  
**13-855-16**  
 16.5cm



**Mead**  
**13-856-16**  
 16.5cm

**Surgery - Chirurgie - Cirugia**  
**Bone Rongeur Forceps**  
**Hohlmeißelzangen**  
**Pinzas-gubias**

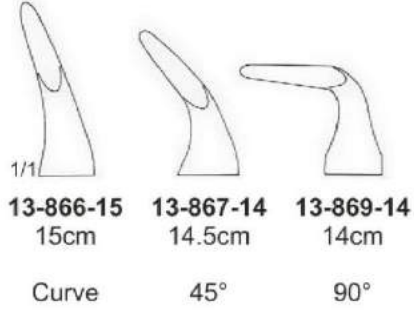

**Bluementhal**  
**13-866-15 - 13-869-14**

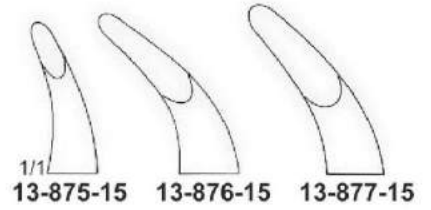

**Luer**  
**13-875-15 - 13-877-15**



**Beyer**  
**13-883-18**  
 18cm

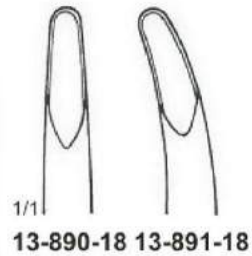
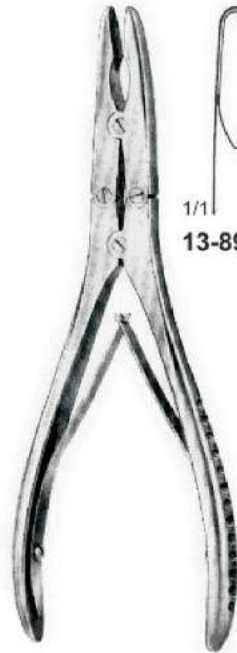

**Ruskin**  
**13-890-18 - 13-891-18**  
 18cm



**Surgery - Chirurgie - Cirugía**  
**Tissue and Organ Holding Forceps**  
**Gewebe-und Organ-Faßzangen**  
**Pinzas para tejidos y organos**

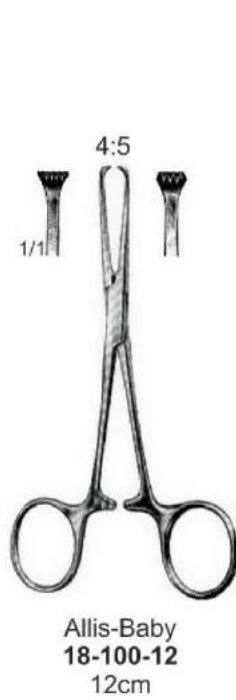

**Surgery - Chirurgie - Cirugía**  
**Mouth Gags**  
**Mundsperrer**  
**Abre-bocas**

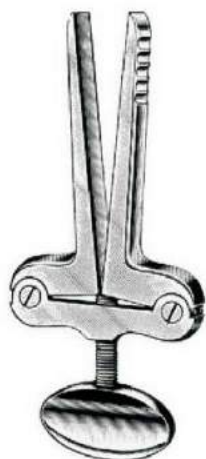

Heister  
 24-100-13  
 13cm



Molt  
 24-141-11  
 11cm



Molt  
 24-141-14  
 14cm



Denhart  
 24-147-12  
 12cm



Roser-Konig  
 24-149-16 16cm  
 24-149-20 20cm

**Surgery - Chirurgie - Cirugía**  
**Cheek and Lip Retractors, Tongue Depressors**  
**Wangen-und Lippenhalter, Zungendrucker**  
**Spearadores para labios y mejillas, Abaja-lenguas**



Simplex  
24-301-11  
11cm



Stemberg  
24-305-12 12cm  
24-305-14 14cm  
24-305-16 16cm



Mod. Martin  
24-309-19  
19cm



Mod. Martin  
24-311-21  
21cm



Bishop  
24-315-13  
13cm



**Surgery - Chirurgie - Cirugía**  
**Cheek and Lip Retractors, Tongue Depressors**  
**Wangen-und Lippenhalter, Zungendrucker**  
**Speardores para labios y mejillas, Abaja-lenguas**

72 x 23mm



Hartmann  
24-321-15  
15cm

88 x 25mm



Tobold  
24-325-14  
14.5cm

85 x 24mm



Tobold  
24-329-14  
14.5cm



Andrew  
24-333-11  
11cm



Wieder  
24-337-01 - 24-337-02



1/1  
24-337-01  
14cm



24-337-02  
15cm



**Surgery - Chirurgie - Cirugía**  
**Tongue Depressors**  
**Zungendrucker**  
**Abaja-lenguas**



**Moritz-Schmidt**  
**24-361-19**  
19cm



**Standard**  
**24-365-14**  
14.5cm

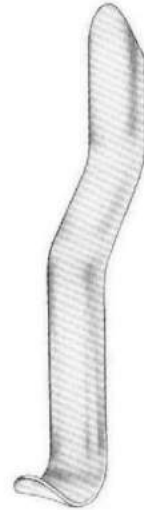

**Univ. Minnesota**  
**24-369-14**  
14cm



**Kroenig**  
**24-371-15**  
15cm



**Mayo**  
**24-375-17**  
17cm



18mm  
**24-379-18**  
18cm  
23mm

**Surgery - Chirurgie - Cirugia**  
**Tongue Depressors**  
**Zungendrucker**  
**Abaja-lenguas**

Wood



**24-381-16**  
16cm

Wood



**24-385-15**  
15cm



Haas  
**24-389-16**  
16cm



Buchwald  
**24-391-17**  
17cm



15mm  
Bruenings  
**24-395-19**  
19cm

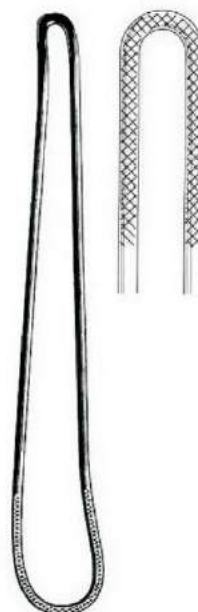

Frenzel  
**24-399-16**  
16.5cm

Surgery - Chirurgie - Cirugía  
Tongue Holding Forceps  
Zungenzangen  
Pinzas tira - lengua

24 x 27mm

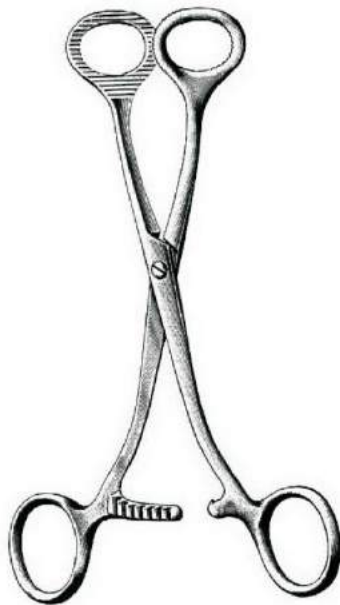

Collin  
24-450-17  
17cm

Rubber inserts



23 x 15mm  
Pair



Young  
24-465-17  
17cm

**Surgery - Chirurgie - Cirugía**  
**Periosteal Elevators, Osteotomes**  
**Raspatorien, Osteotome**  
**Periostotomos, Osteotomos**

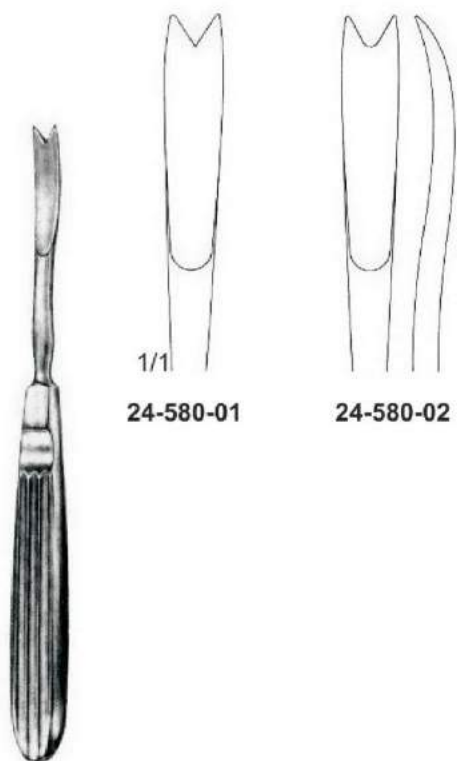

1/1  
**24-580-01**

**24-580-02**

Obwegeser  
**24-580-01 - 24-580-02**  
 17.5cm



1/1

Obwegeser  
**24-586-21**  
 21cm



1/1

Obwegeser  
**24-588-21**  
 21cm

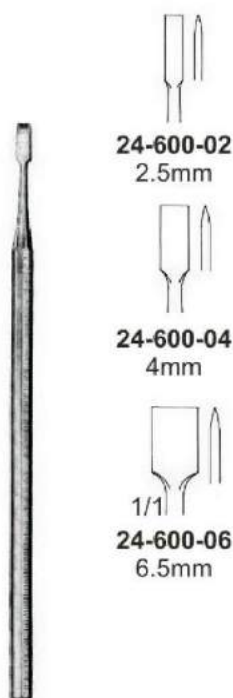

**24-600-02**  
 2.5mm

**24-600-04**  
 4mm

1/1  
**24-600-06**  
 6.5mm

Obwegeser  
**24-600-02 - 24-600-06**  
 15cm

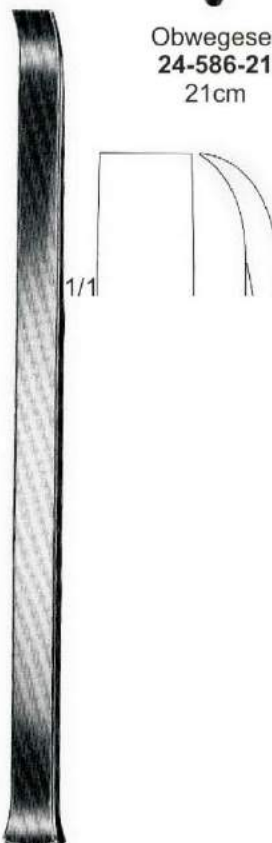

1/1

Obwegeser  
**24-606-23**  
 23cm



1/1

**24-610-01 24-610-02**

Obwegeser  
**24-610-01 - 24-610-02**  
 18.5cm



**Surgery - Chirurgie - Cirugía**  
**Nail Scissors, Nail Nippers**  
**Nagelscheren, Nagelzangen**  
**Tijeras para uñas, Pinzas corta - uñas**



**29-100-10**  
10cm



**29-105-10**  
10cm



**29-120-14**  
14cm



**29-124-14** 14cm  
**29-124-16** 16cm



Turnbull  
**29-128-11** 11.5cm  
**29-128-13** 13.0cm



**29-132-13**  
13cm



**29-136-12**  
12cm



**29-140-11** 11cm  
**29-140-13** 13cm  
**29-140-15** 15cm

**Surgery - Chirurgie - Cirugía**  
**Cuticle Nippers, Cuticle Scissors, Nail Files**  
**Nagelhautzangen, Hautscheren, Nagelfeilen**  
**Pinzas y Tijeras cuticulares, Lima para uñas**



29-144-11 11cm  
29-144-13 13cm



29-148-10  
10.5cm

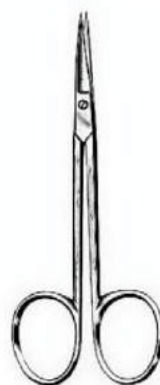

29-160-10  
10.5cm

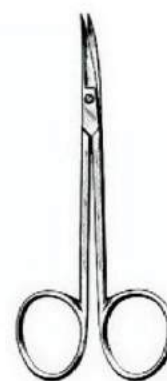

29-161-10  
10.5cm

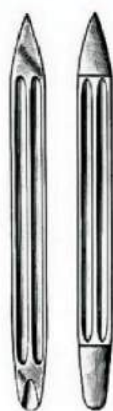

29-170-11  
11cm



29-172-10 10cm  
29-172-12 12cm



29-174-11  
11cm



29-176-16  
16cm



**Surgery - Chirurgie - Cirugía**  
**Sterilizing Forceps**  
**Sterilisierzangen**  
**Pinzas para esterilización**



**29-192-16** 16cm  
**29-192-24** 24cm



**29-196-20** 20cm  
**29-196-28** 28cm



**29-197-20** 20cm  
**29-197-28** 28cm



**Surgery - Chirurgie - Cirugía**  
**Sterilizing Forceps**  
**Sterilisierzangen**  
**Pinzas para esterilización**



Cheattle  
29-211-27  
27cm



29-215-20 20cm  
29-215-30 30cm



Rogge  
29-219-23  
23cm



**Surgery - Chirurgie - Cirugía**  
**Sterilizing Forceps**  
**Sterilisierzangen**  
**Pinzas para esterilización**



**29-230-24**  
24cm



**Ulleval**  
**29-235-24**  
24cm



**Harrison**  
**29-239-30**  
30cm



**Surgery - Chirurgie - Cirugía**  
**Alcohol Burners**  
**Spitiuslampen**  
**Lámparas de alcohol**



**29-730-10** 100cc  
**29-730-12** 120cc  
**29-730-15** 150cc  
**29-730-20** 200cc



**29-734-10** 100cc  
**29-734-12** 120cc  
**29-734-15** 150cc  
**29-734-20** 200cc



**29-738-10** 100cc  
**29-738-12** 120cc  
**29-738-15** 150cc  
**29-738-20** 200cc



**Measuring Instruments**  
**Messinstrumente**  
**Instrumentos para mesurer**



- 53-100-15** 15 cm
  - 53-100-20** 20 cm
  - 53-100-30** 30 cm
  - 53-100-50** 50 cm
- Graduated in mm : in

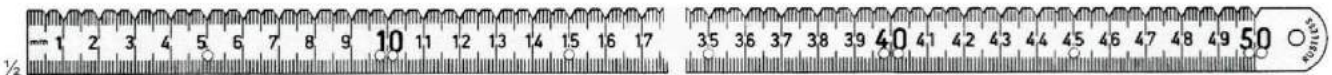

- 53-104-50** 50 cm
- X-Ray



- 53-108-15**
- 15 cm



**Measuring Instruments**  
**Messinstrumente**  
**Instrumentos para mesurer**



**Beerendonk**  
**53-110-00**



**Boley**  
**53-114-00**

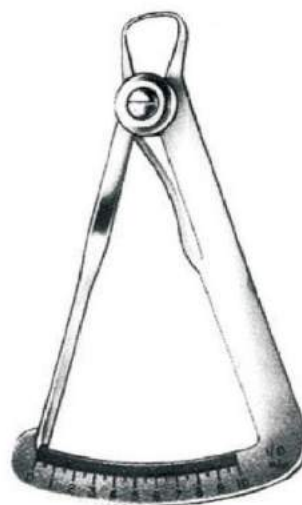

**Iwanson**

One side graduation  
**53-120-01 - Metal**  
**53-120-02 - Wax**

Double sided graduation  
**53-130-01 - Metal**  
**53-130-02 - Wax**

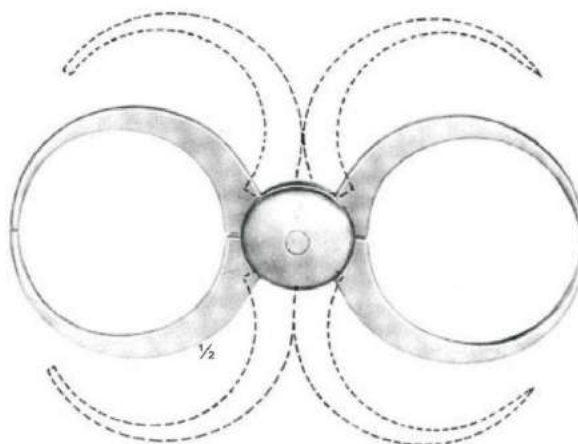

**Bow**  
**53-140-00**





**Dental Tweezers**  
**Zahnpinzetten**  
**Pinzas para algodón**



**54-100-01**  
**54-102-01**  
 Fig. 01

**54-100-02**  
**54-102-02**  
 Fig. 02

**54-100-03**  
**54-102-03**  
 Fig. 03

**54-100-04**  
**54-102-04**  
 Fig. 04



London College  
**54-100-01 - 54-100-08**  
 15cm



London College  
**54-102-01 - 54-102-08**  
 15cm



1/1

**54-100-05**  
**54-102-05**  
 Fig. 05

**54-100-06**  
**54-102-06**  
 Fig. 06

**54-100-08**  
**54-102-08**  
 Fig. 08

**Dental Tweezers**  
**Zahnpinzetten**  
**Pinzas para algodón**



1/1

**54-104-01**  
**54-106-01**  
Fig. 01



**54-104-02**  
**54-106-02**  
Fig. 02



**54-104-03**  
**54-106-03**  
Fig. 03



**54-104-04**  
**54-106-04**  
Fig. 04



**54-106-05**  
Fig. 05



**54-106-06**  
Fig. 06

Meriam  
**54-104-01 - 54-104-04**  
16cm

Meriam  
**54-106-01 - 54-106-06**  
16cm

**Dental Scalers**  
**Reinigungsinstrumente**  
**Limpiadores de sarro**



54-110-01 - 54-110-36  
15.5cm



54-110-01  
Fig. 1



54-110-02  
Fig. 2



54-110-03  
Fig. 3



54-110-32  
Fig. 32



54-110-33  
Fig. 33



54-110-34  
Fig. 34



54-110-35  
Fig. 35



54-110-36  
Fig. 36

**Dental Scalers**  
Zahnreiniger  
Limpiadores de sarro

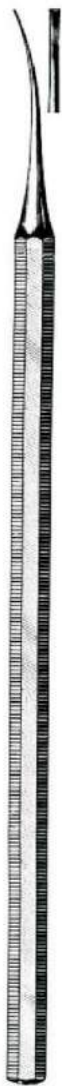

54-112-01 - 54-118-18



Darby-Perry  
54-112-01  
Fig. 1



Darby-Perry  
54-112-04  
Fig. 4



Darby-Perry  
54-112-05  
Fig. 5



Darby-Perry  
54-112-06  
Fig. 6



Darby-Perry  
54-112-11  
Fig. 11



White  
54-114-12  
Fig. 12B



Jaquette  
54-116-01  
Fig. 33



Jaquette  
54-116-02  
Fig. 34



Jaquette  
54-116-03  
Fig. 35



McCall  
54-118-17  
Fig. 17



McCall  
54-118-18  
Fig. 18

Dental Scalers  
Zahnreiniger  
Limpiadores de sarro

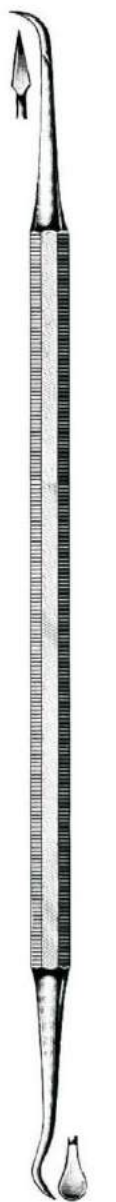

Cumine  
54-120-02

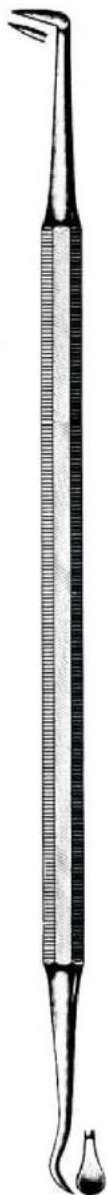

Mitchell  
54-122-02



54-124-02  
Fig. 33/34

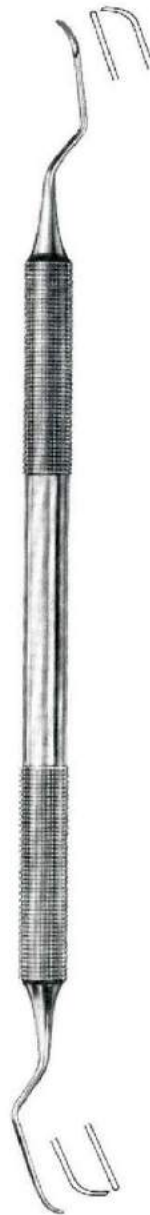

Columbia  
54-126-02  
Fig. 2R/2L

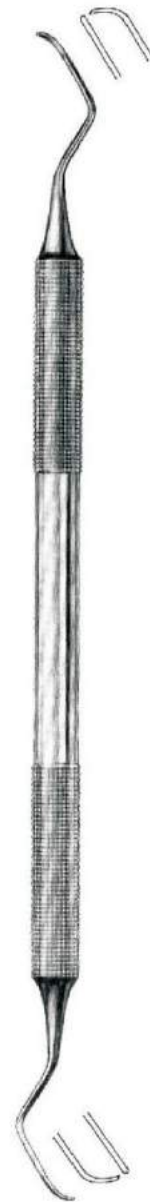

Columbia  
54-126-04  
Fig. 4R/4L



Columbia  
54-126-14  
Fig. 13/14

Dental Scalers  
Zahnreiniger  
Limpiadores de sarro



Younger-Good  
54-128-02  
Fig. 7/8

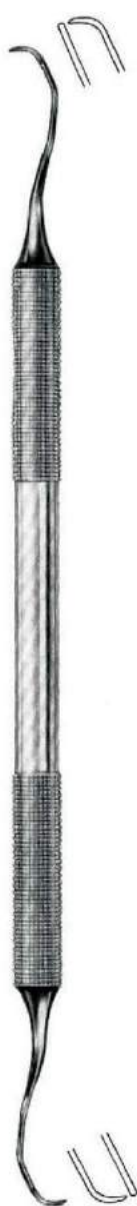

Langer  
54-130-02  
Fig. 1/2



Langer  
54-130-04  
Fig. 3/4



Langer  
54-130-06  
Fig. 5/6

Periodontia Instruments  
Instrumente zur Parodontologie  
Instrumentos para Periodoncia

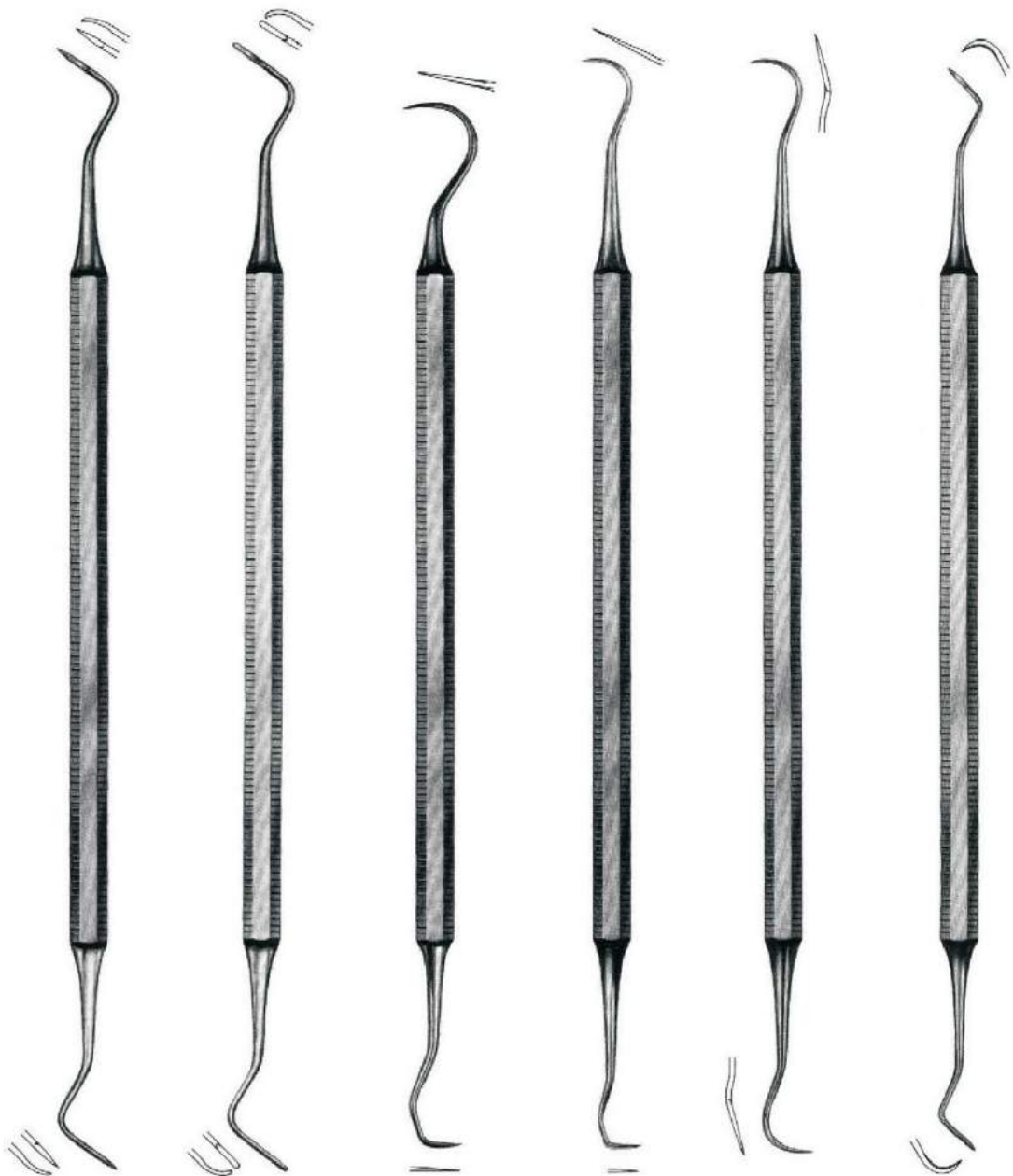

McCall  
54-136-01  
Fig. 13S/14S

McCall  
54-136-02  
Fig. 13/14

Towner-Jaquette  
54-140-00  
Fig. 15/30

54-142-00  
Fig. 5/33

Hygienist  
54-144-00  
Fig. 6/7

54-146-00  
Fig. 204S

Periodontia Instruments  
Instrumente zur Parodontologie  
Instrumentos para Periodoncia

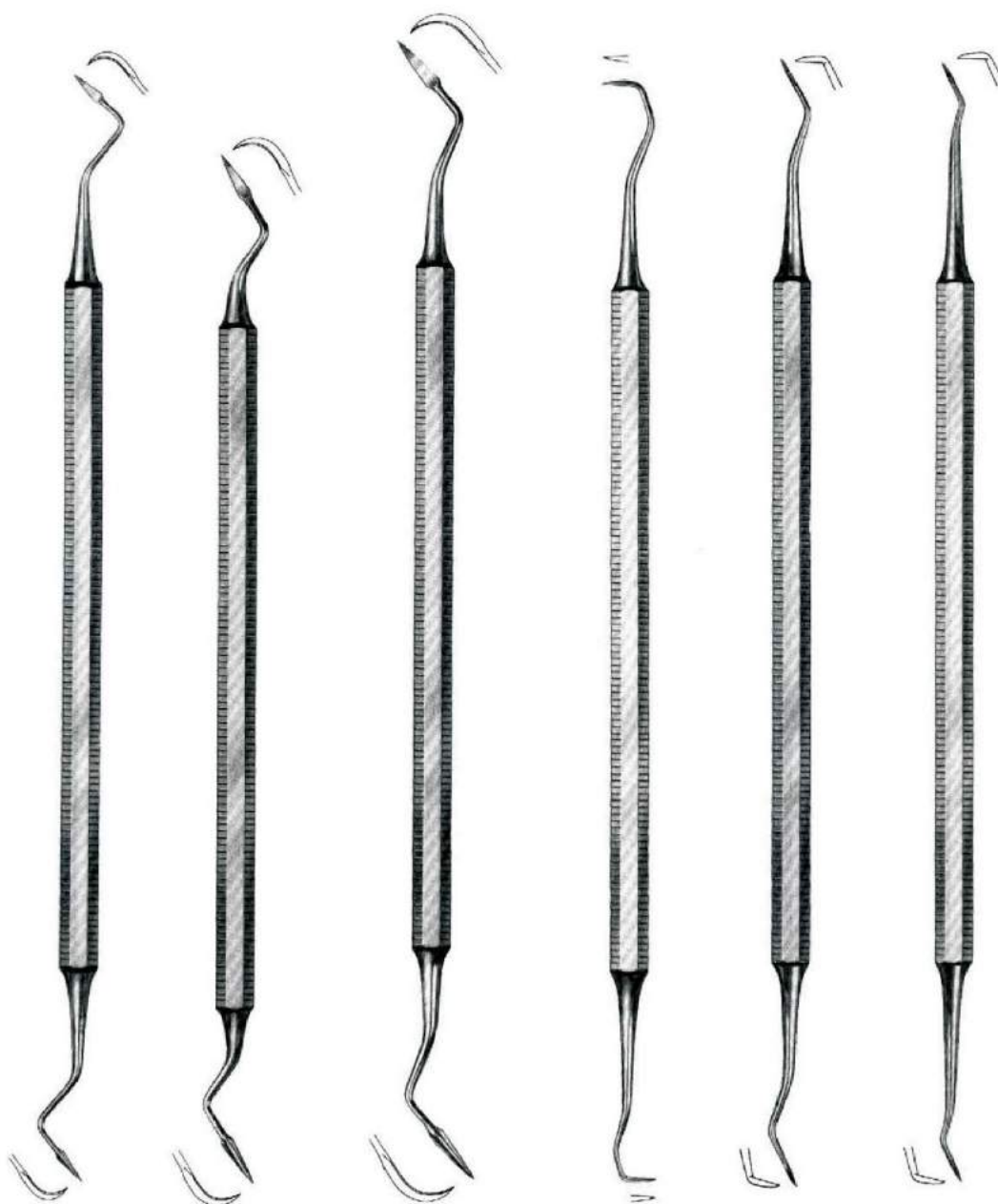

**54-150-01**  
Fig. ST 2/3

**54-150-02**  
Fig. SCI 2/3

**54-150-03**  
Fig. SCK 6

Jaquette  
**54-152-01**  
Fig. 30/33

Jaquette  
**54-152-02**  
Fig. 31/32

Jaquette  
**54-152-03**  
Fig. 34/35



**Periodontia Instruments**  
**Instrumente zur Parodontologie**  
**Instrumentos para Periodoncia**

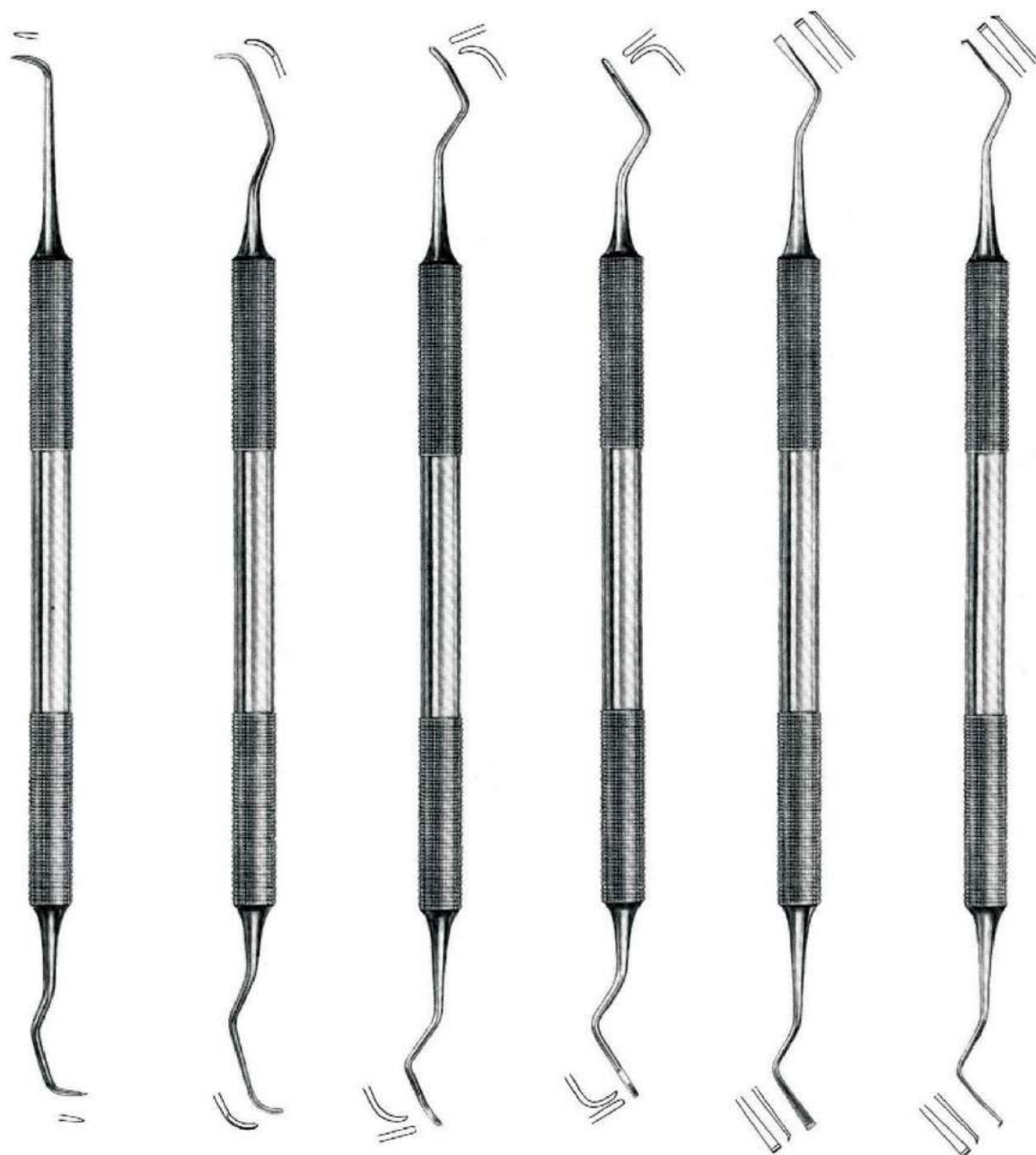

Goldman Fox  
54-160-01  
Fig. 1

Goldman Fox  
54-160-02  
Fig. 2

Goldman Fox  
54-160-03  
Fig. 3

Goldman Fox  
54-160-04  
Fig. 4

Goldman Fox  
54-160-05  
Fig. 5

Goldman Fox  
54-160-06  
Fig. 6

**Periodontia Instruments**  
**Instrumente zur Parodontologie**  
**Instrumentos para Periodoncia**



**Goldman Fox**  
**54-160-07**  
 Fig. 7

**Goldman Fox**  
**54-160-08**  
 Fig. 8

**Goldman Fox**  
**54-160-09**  
 Fig. 9

**Goldman Fox**  
**54-160-10**  
 Fig. 10

**Goldman Fox**  
**54-160-11**  
 Fig. 11

**Goldman Fox**  
**54-160-21**  
 Fig. 21

**Periodontia Instruments**  
**Instrumente zur Parodontologie**  
**Instrumentos para Periodoncia**



Gracey  
54-162-02  
Fig. 1/2



Gracey  
54-162-04  
Fig. 3/4

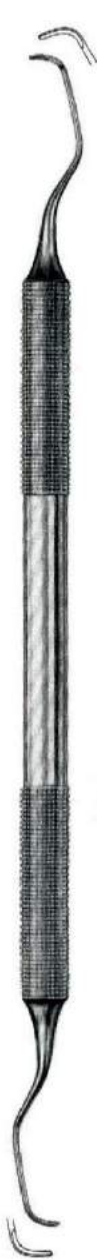

Gracey  
54-162-06  
Fig. 5/6



Gracey  
54-162-08  
Fig. 7/8



Gracey  
54-162-10  
Fig. 9/10

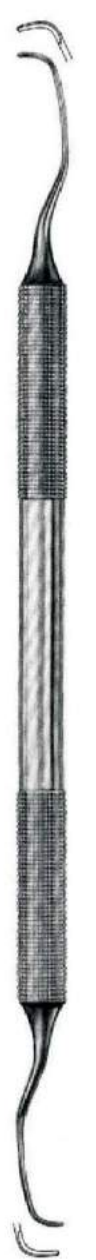

Gracey  
54-162-12  
Fig. 11/12



Gracey  
54-162-14  
Fig. 13/14

Periodontia Instruments  
Instrumente zur Parodontologie  
Instrumentos para Periodoncia

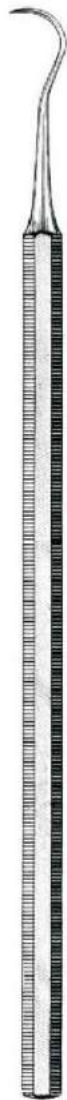

54-164-02  
Fig. SH 5

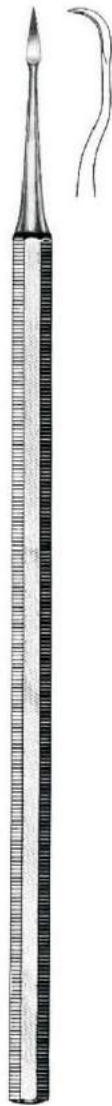

Ward-Kirkland  
54-166-01

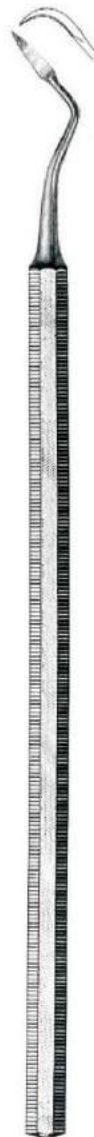

Crane-Kaplan  
54-166-02



Crane-Kaplan  
54-166-03

**Periodontia Instruments**  
**Instrumente zur Parodontologie**  
**Instrumentos para Periodoncia**



Kirkland  
54-168-15

Kirkland  
54-168-16

Kirkland  
54-170-16

54-172-01

Crane-Kaplan  
54-174-01

Crane-Kaplan  
54-174-02

**Periodontia Instruments**  
**Instrumente zur Parodontologie**  
**Instrumentos para Periodoncia**

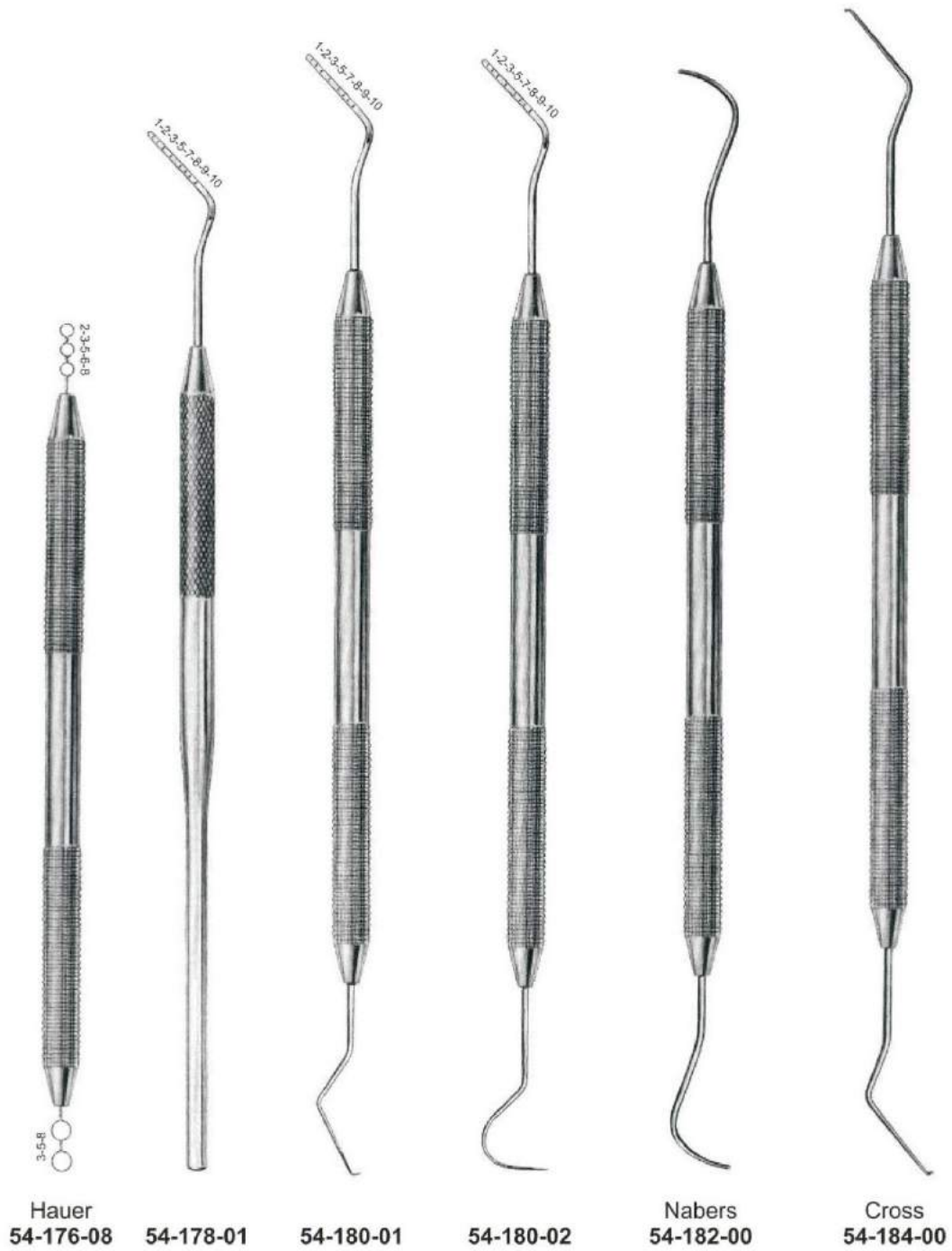

**Periodontia Instruments**  
**Instrumente zur Parodontologie**  
**Instrumentos para Periodoncia**

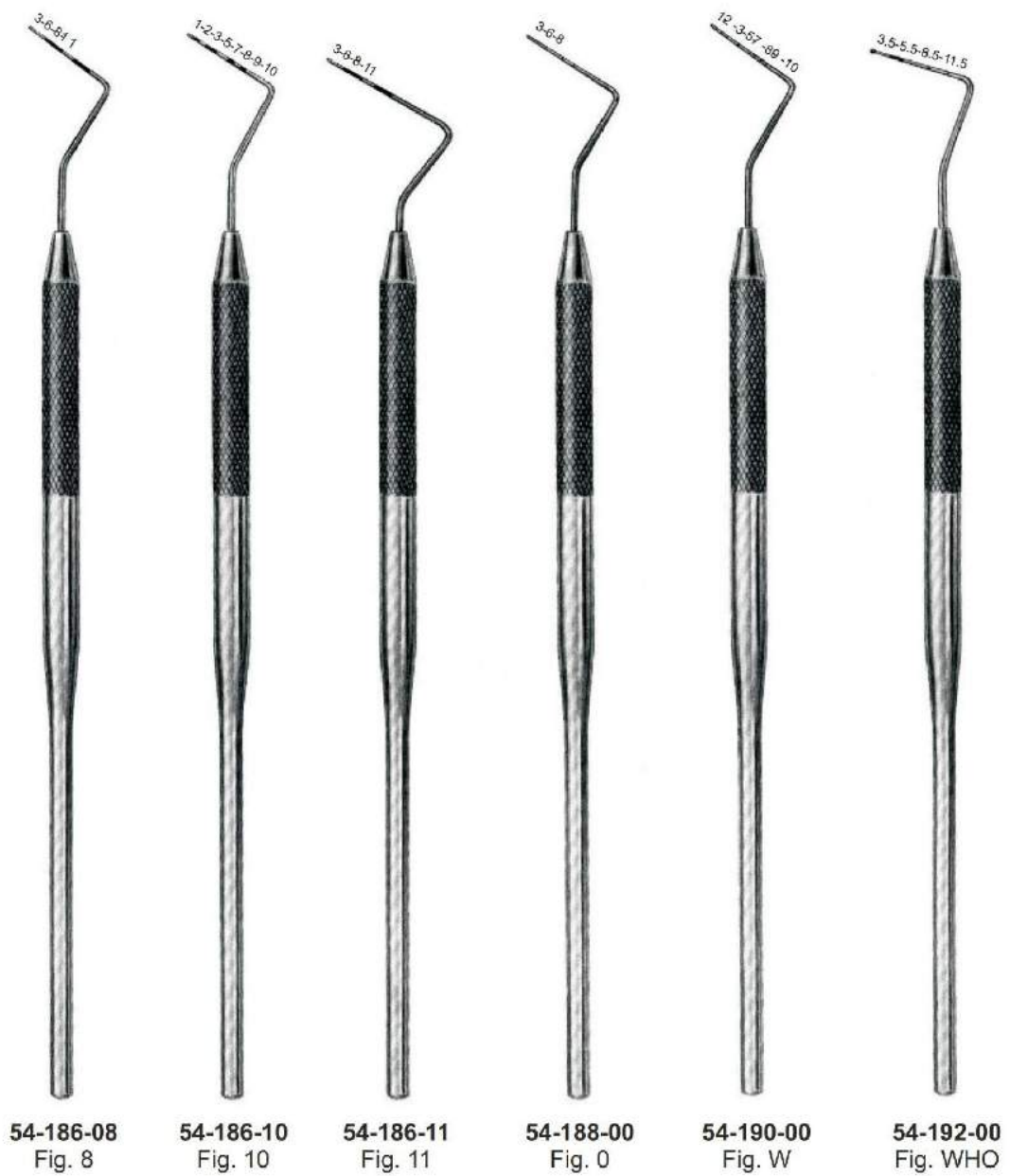

**Periodontia Instruments**  
**Instrumente zur Parodontologie**  
**Instrumentos para Periodoncia**



Ochsenbein  
**54-200-01**  
 Fig. 1



Ochsenbein  
**54-200-02**  
 Fig. 2



Ochsenbein  
**54-200-03**  
 Fig. 3



Ochsenbein  
**54-200-04**  
 Fig. 4



**Periodontia Instruments**  
**Instrumente zur Paradontologie**  
**Instrumentos para Periodoncia**



**Fedi**  
**54-202-01**  
 Fig. 1



**Fedi**  
**54-202-02**  
 Fig. 2



**Fedi**  
**54-202-03**  
 Fig. 3

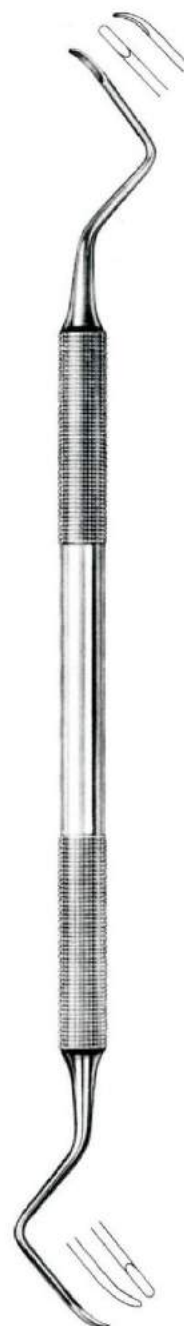

**Prichard**  
**54-204-00**

**Probes and Explorers**  
**Zahnsonden**  
**Sondas y Exploradores**

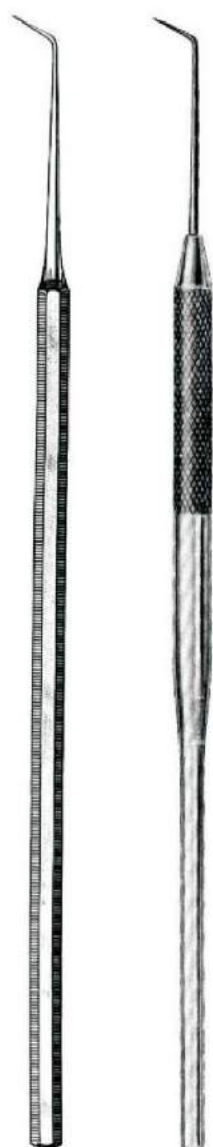

54-206-03 to 54-210-90  
54-208-03 to 54-212-90

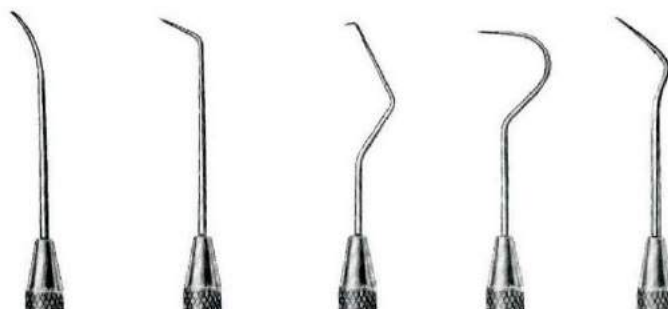

54-206-03 54-206-06 54-206-17 54-206-23 54-206-33  
54-208-03 54-208-06 54-208-17 54-208-23 54-208-33  
Fig. 3 Fig. 6 Fig. 17 Fig. 23 Fig. 33



54-206-35 54-206-42 54-206-43 54-206-44 54-206-54  
54-208-35 54-208-42 54-208-43 54-208-44 54-208-54  
Fig. 35 Fig. 42 Fig. 43 Fig. 44 Fig. 54



54-210-60 54-210-61 54-210-80 54-210-81 54-210-90  
54-212-60 54-212-61 54-212-80 54-212-81 54-212-90  
Fig. 6 Fig. 6a Fig. 8 Fig. 8a Fig. 9

**Probes and Explorers**  
**Zahnsonden**  
**Sondas y Exploradores**

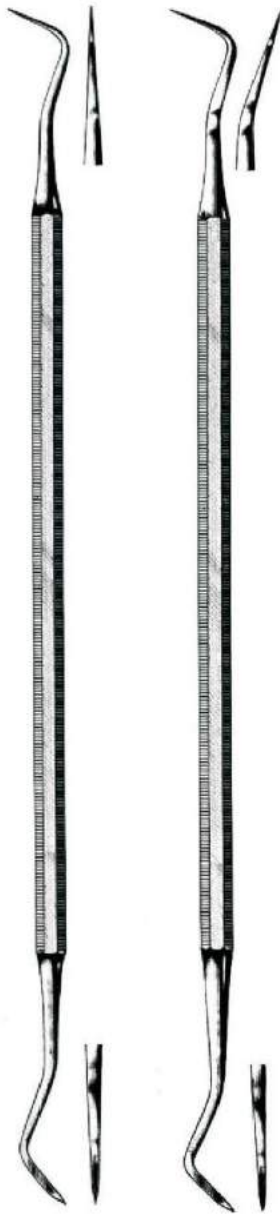

Lange  
54-220-01

Lange  
54-220-02

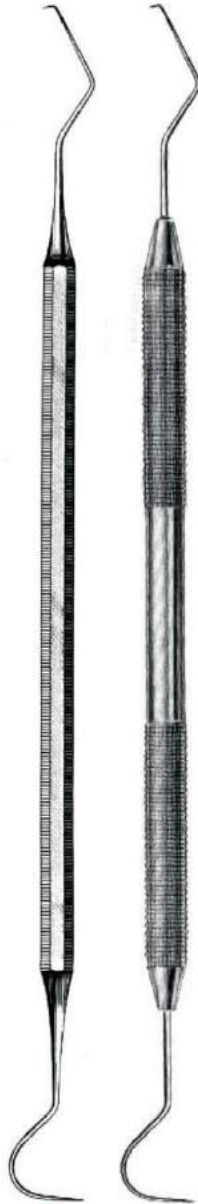

54-230-01 54-232-01  
to to  
54-230-04 54-232-04



54-230-01  
54-232-01  
Fig. 17/23

54-230-02  
54-232-02  
Fig. 2

54-230-03  
54-232-03  
Fig. 3

54-230-06  
54-232-06  
Fig. 23/6



**Excavators  
Exkavatoren  
Excavadores**



**54-236-05**  
Fig. 5/6



**54-236-07**  
Fig. 7/8



**54-236-09**  
Fig. 9/10



**54-236-11**  
Fig. 11/12



**54-236-13**  
Fig. 13/14



**54-236-15**  
Fig. 15/16



**54-236-17**  
Fig. 17/18



**54-236-19**  
Fig. 19/20



**54-250-21**  
Fig. 21/22



Darby-Perry  
**54-236-05**  
to  
**54-236-22**

**Excavators  
Exkavatoren  
Excavadores**



54-240-12 - 54-242-79



**54-240-12**  
Fig. 12/13



**54-240-14**  
Fig. 14/15



**54-242-71**  
Fig. 171/172



**54-242-73**  
Fig. 173/174



**54-242-75**  
Fig. 175/176



**54-242-77**  
Fig. 177/178



**54-242-79**  
Fig. 179/180

**Excavators  
Exkavatoren  
Excavadores**



54-246-04 - 54-246-24



54-246-04  
Fig. 3/4



54-246-08  
Fig. 7/8



54-246-10  
Fig. 9/10



54-246-12  
Fig. 11/12



54-246-14  
Fig. 13/14



54-246-16  
Fig. 15/16



54-246-18  
Fig. 17/18



54-246-20  
Fig. 19/20



54-246-22  
Fig. 21/22



54-246-24  
Fig. 23/24





**Cutting Instruments**  
**Schneidende Instrumente**  
**Instrumentos de cortantes**

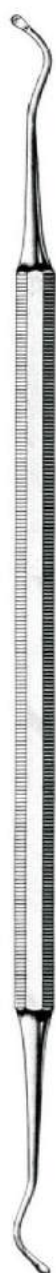

**54-250-05**  
to  
**54-250-20**



**White**  
**54-250-05**  
Fig. 5



**White**  
**54-250-14**  
Fig. 14



**White**  
**54-250-17**  
Fig. 17



**White**  
**54-250-18**  
Fig. 18



**White**  
**54-250-19**  
Fig. 19



**White**  
**54-250-20**  
Fig. 20



Excavators  
Exkavatoren  
Excavadores

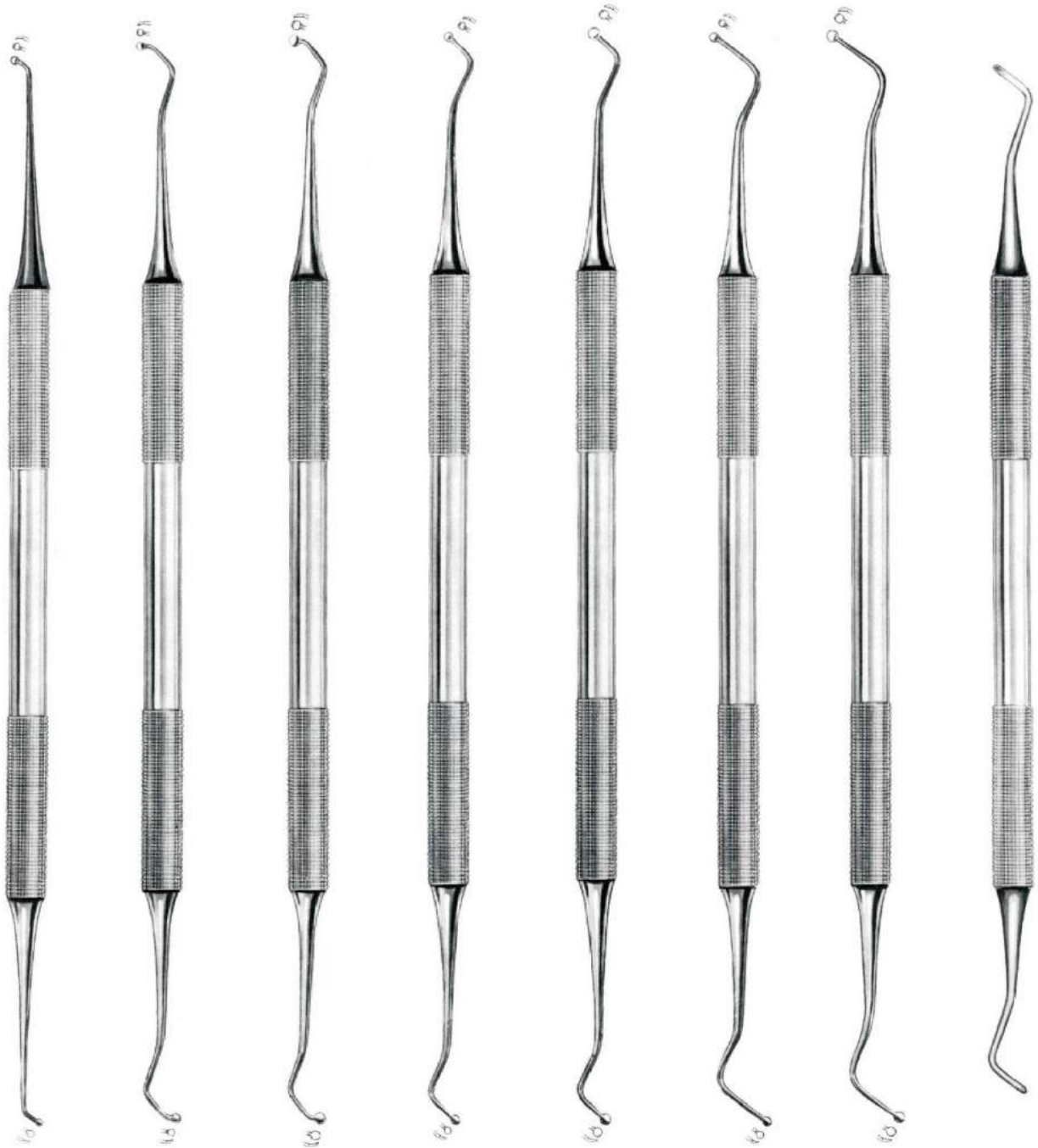

54-256-05

54-256-13

54-256-14

54-256-17

54-256-18

54-256-31

54-256-33

54-256-35





**Cutting Instruments**  
**Schneidende Instrumente**  
**Instrumentos de cortantes**

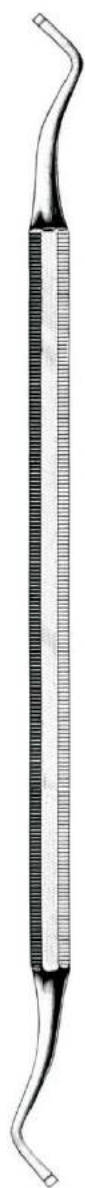

**54-260-52**  
Fig. 51/52



**54-260-54**  
Fig. 53/54



**54-260-64**  
Fig. 63/64



**54-260-66**  
Fig. 65/66



**54-260-78**  
Fig. 77/78



**54-260-80**  
Fig. 79/80

**54-260-52**  
to  
**54-260-80**



**Nerve Instruments**  
**Nervinstrumente**  
**Instrumentos para nervios**



1/1



**54-266-08**  
Fig. 8



**54-266-09**  
Fig. 9



**54-266-10**  
Fig. 10



**54-266-11**  
Fig. 11



**54-266-12**  
Fig. 12



Luks  
**54-268-01**  
Fig. 1



Luks  
**54-268-02**  
Fig. 2



Luks  
**54-268-03**  
Fig. 3



Luks  
**54-268-04**  
Fig. 4



**Nerve Instruments**  
**Nervinstrumente**  
**Instrumentos para nervios**

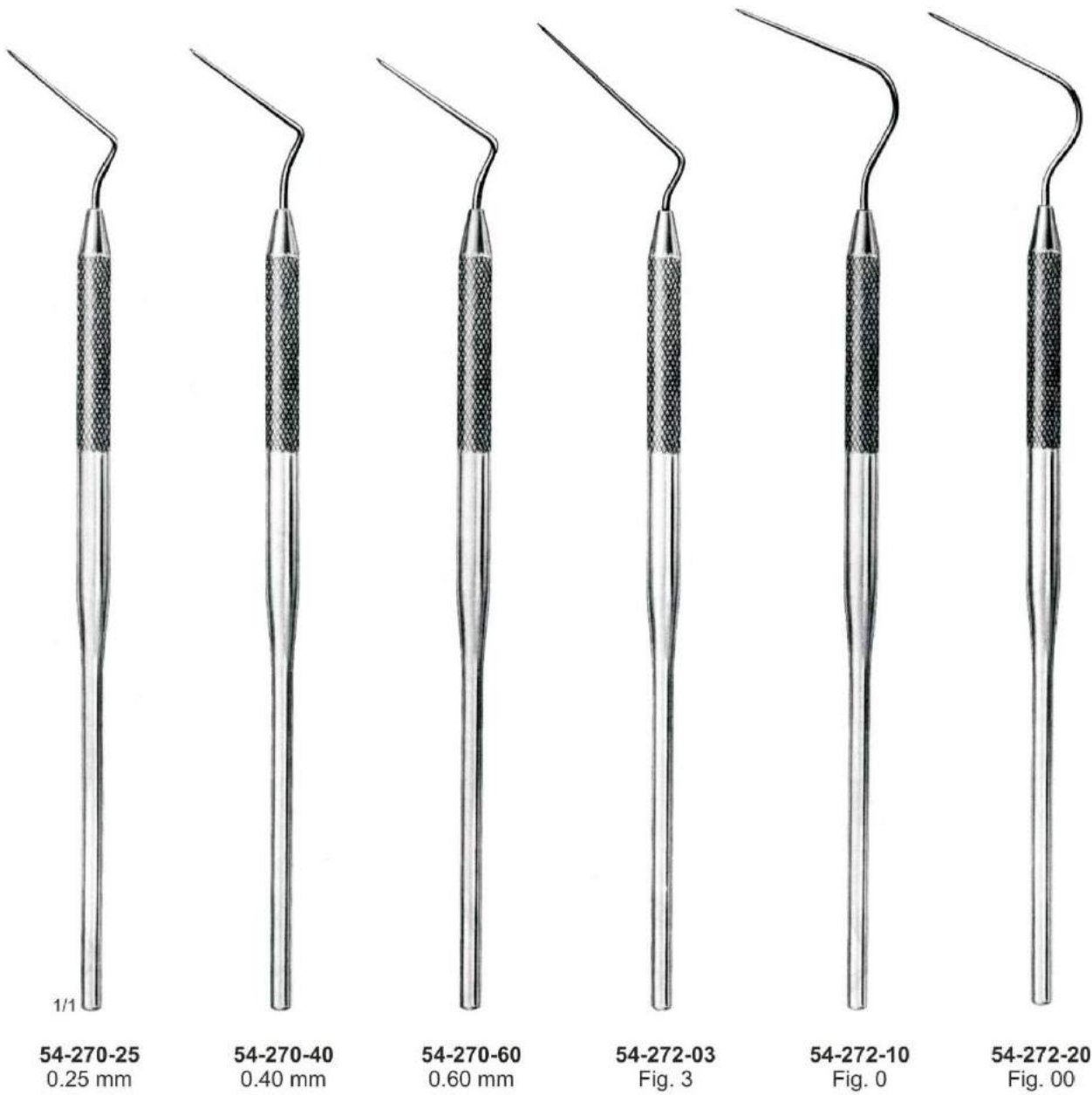

**Instruments for Amalgam**  
**Instrumente für Amalgam**  
**Instrumentos para amalgama**

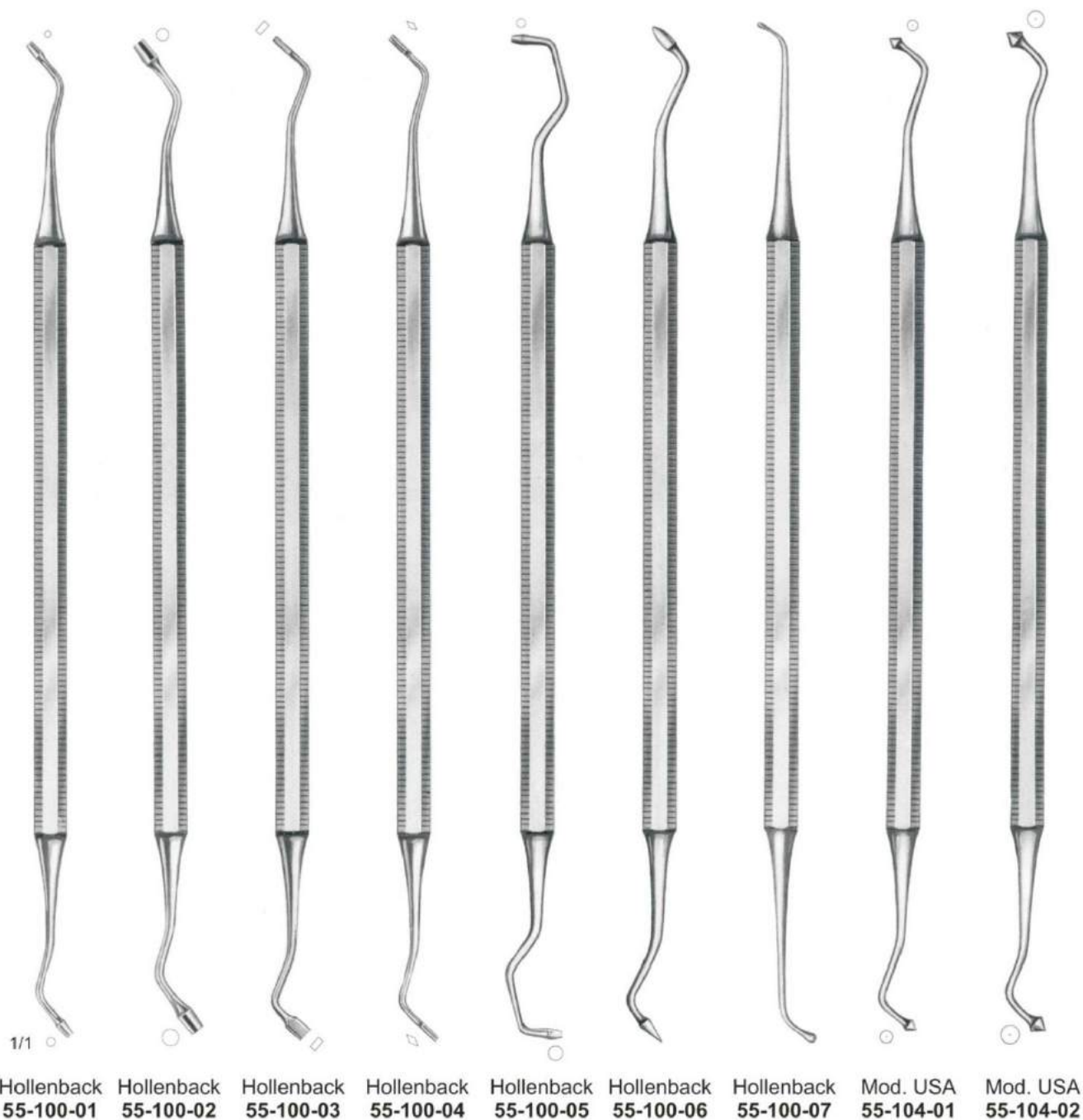



**Instruments for Amalgam**  
**Instrumente für Amalgam**  
**Instrumentos para amalgama**

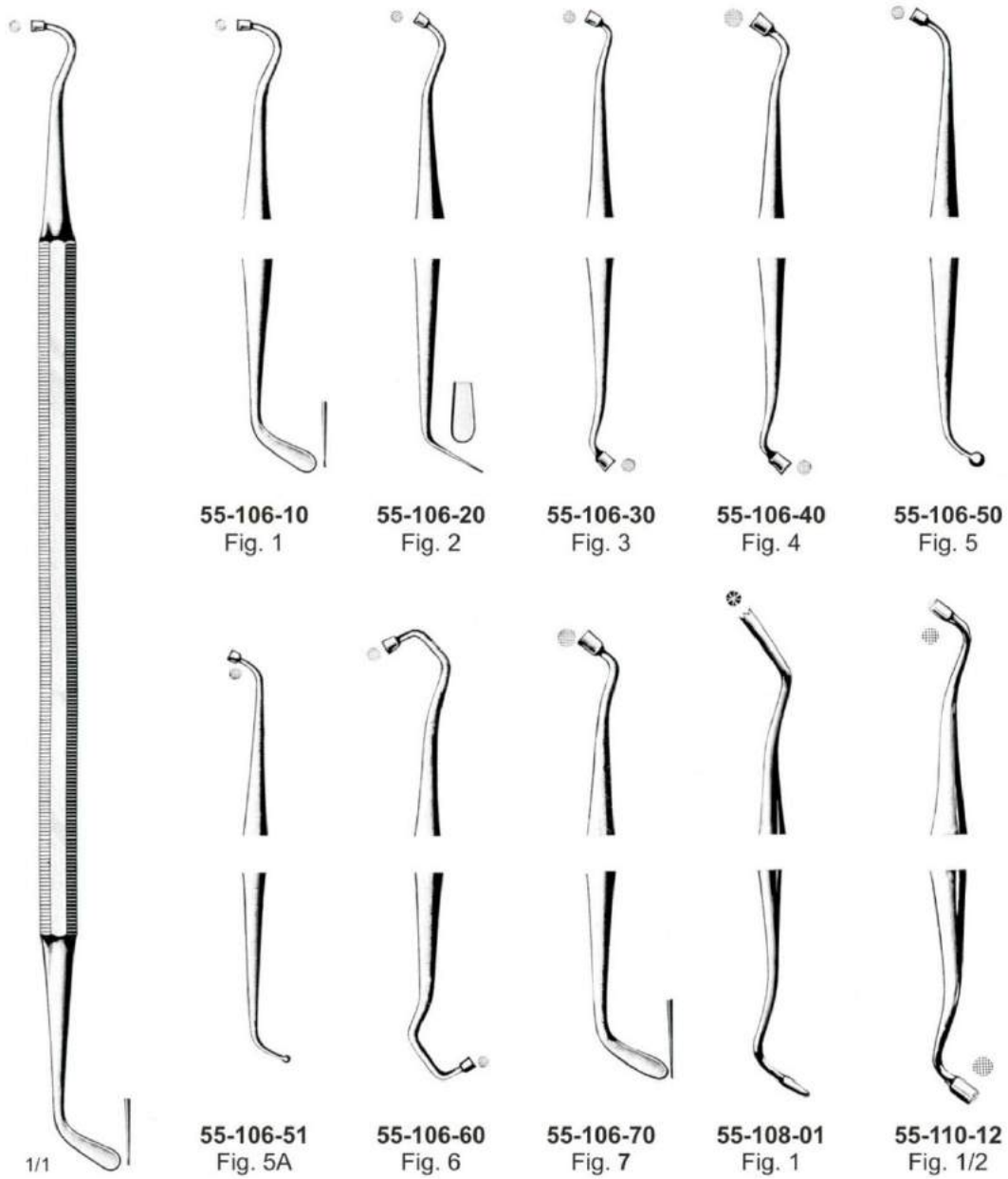

55-106-10 - 55-110-12



**Amalgam Instruments**  
**Amalgam-Instrumente**  
**Instrumentos para amalgama**





**Amalgam Instruments**  
**Amalgam-Instrumente**  
**Instrumentos para amalgama**





**Amalgam Instruments, Finger Cups**  
**Amalgam-Instrumente, Fingerbecher**  
**Instrumentos para amalgama, vasos de dedo**



55-130-30  
Ø30 mm



55-132-30  
Ø30 mm

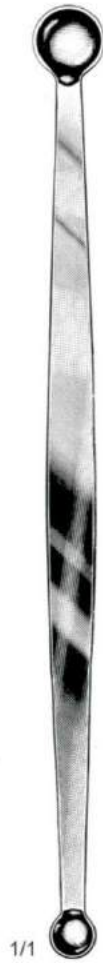

1/1

55-134-00

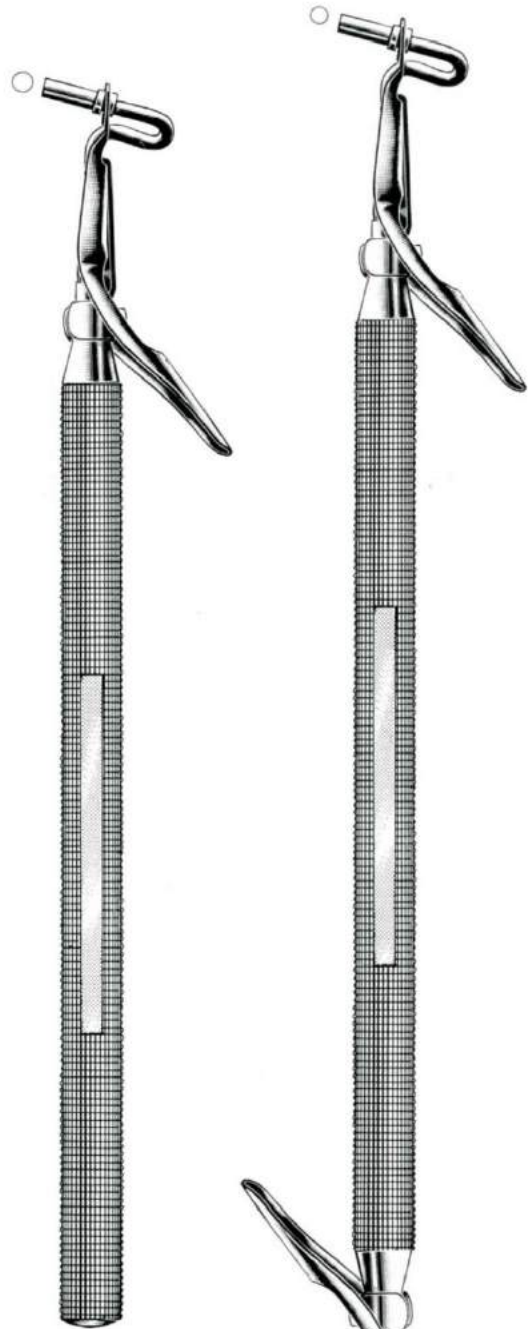

Ivory  
55-136-17

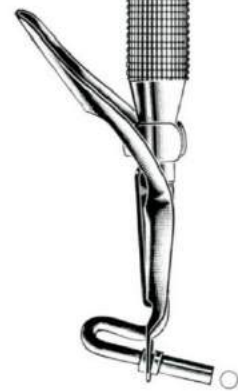

Ivory  
55-136-21





**Burnishers  
Polierinstrumente  
Brunidores**

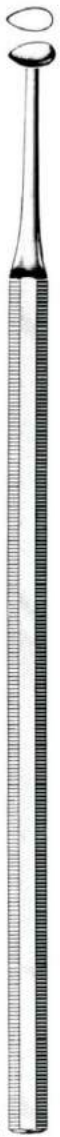

1/1

White  
55-140-28  
to  
55-140-33



White  
55-140-28



White  
55-140-29



White  
55-140-31



White  
55-140-32



White  
55-140-33



Plastic Filling Instruments  
Instrumente für Plastische Füllungen  
Instrumentos para Obturaciones plasticas

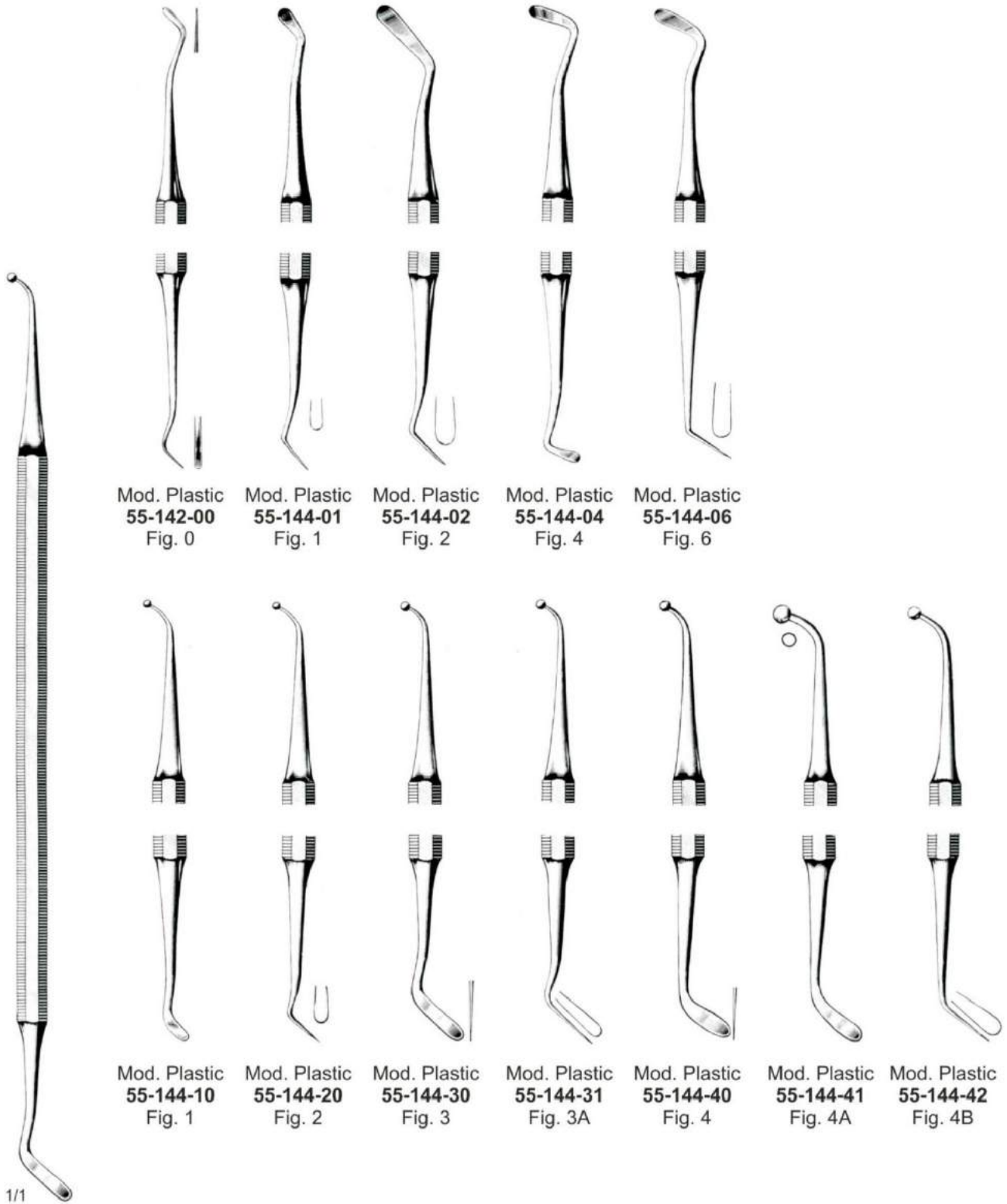

Mod. Plastic  
55-142-00  
Fig. 0

Mod. Plastic  
55-144-01  
Fig. 1

Mod. Plastic  
55-144-02  
Fig. 2

Mod. Plastic  
55-144-04  
Fig. 4

Mod. Plastic  
55-144-06  
Fig. 6

Mod. Plastic  
55-144-10  
Fig. 1

Mod. Plastic  
55-144-20  
Fig. 2

Mod. Plastic  
55-144-30  
Fig. 3

Mod. Plastic  
55-144-31  
Fig. 3A

Mod. Plastic  
55-144-40  
Fig. 4

Mod. Plastic  
55-144-41  
Fig. 4A

Mod. Plastic  
55-144-42  
Fig. 4B

1/1  
55-142-00  
to  
55-144-42



**Plastic Filling Instruments**  
**Instrumente für Plastische Füllungen**  
**Instrumentos para Obturaciones plasticas**

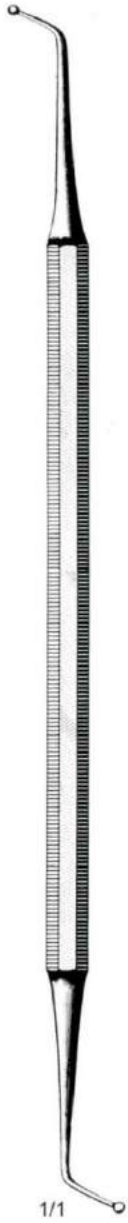

55-144-50  
to  
55-146-19



Mod. Plastic  
55-144-50  
Fig. 5



Mod. Plastic  
55-144-51  
Fig. 5A



Mod. Plastic  
55-144-52  
Fig. 5B



Mod. Plastic  
55-144-60  
Fig. 6

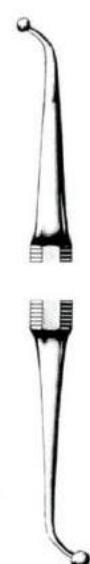

Mod. Plastic  
55-144-70  
Fig. 7



Mod. Plastic  
55-144-71  
Fig. 7A



Mod. Plastic  
55-144-72  
Fig. 7B

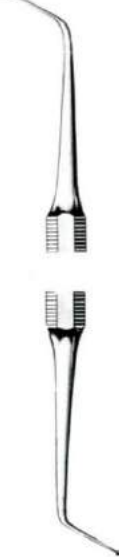

55-146-16  
Fig. 19

**Plastic Filling Instruments**  
**Instrumente für Plastische Füllungen**  
**Instrumentos para Obturaciones plasticas**

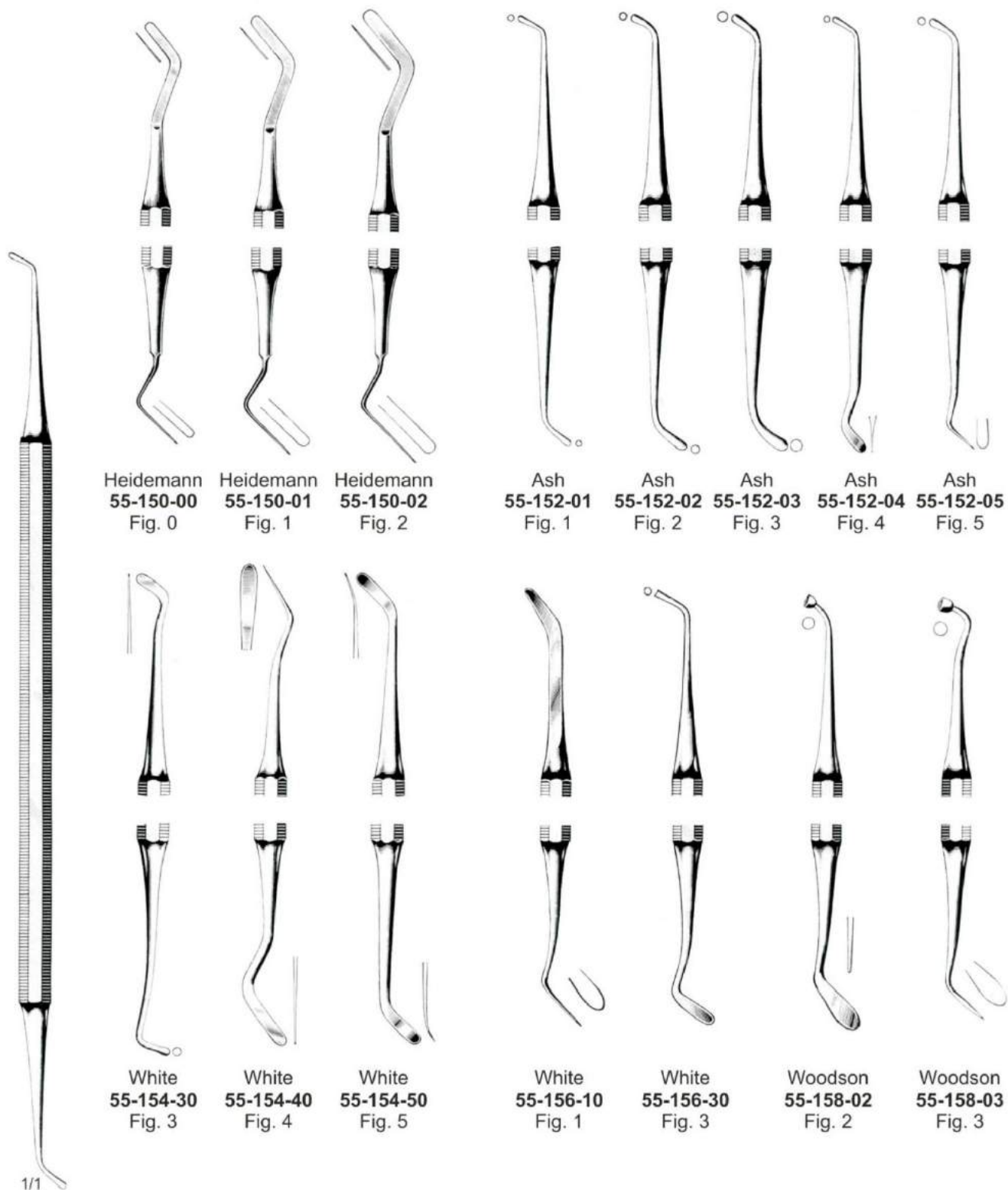

55-150-00  
to  
55-158-03



**Plastic Filling Instruments**  
**Instrumente für Plastische Füllungen**  
**Instrumentos para Obturaciones plasticas**



1/1

**55-160-00**  
to  
**55-166-07**



**Williams**  
**55-160-00**  
Fig. 0



**Williams**  
**55-160-01**  
Fig. 1



**Williams**  
**55-160-02**  
Fig. 2



**Bennet**  
**55-166-07**  
Fig. 7



**Plastic Filling Instruments**  
**Instrumente für Plastische Füllungen**  
**Instrumentos para Obturaciones plasticas**

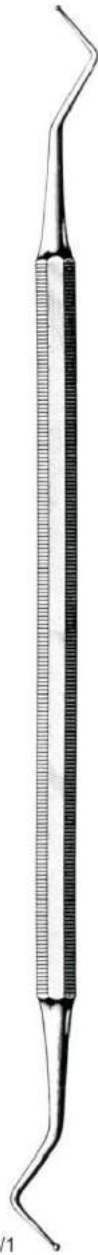

55-180-01 - 55-180-08



55-180-01  
Fig. 1

55-180-02  
Fig. 2

55-180-03  
Fig. 3

55-180-04  
Fig. 4

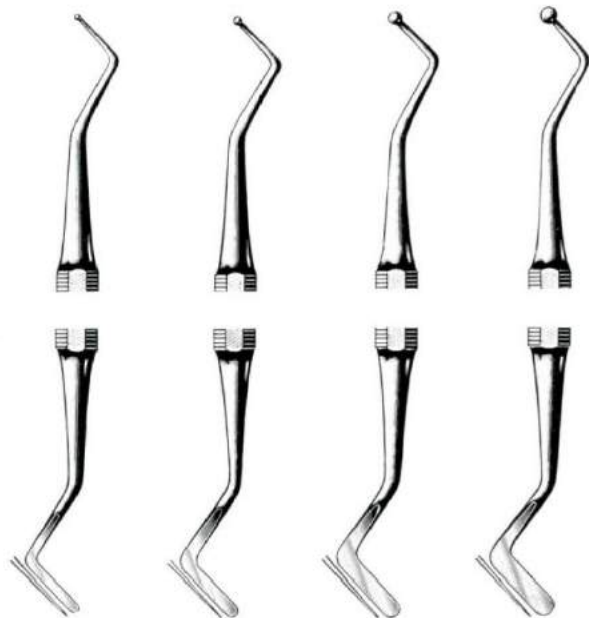

55-180-05  
Fig. 5

55-180-06  
Fig. 6

55-180-07  
Fig. 7

55-180-08  
Fig. 8



Plastic Filling Instruments  
Instrumente für Plastische Füllungen  
Instrumentos para Obturaciones plasticas

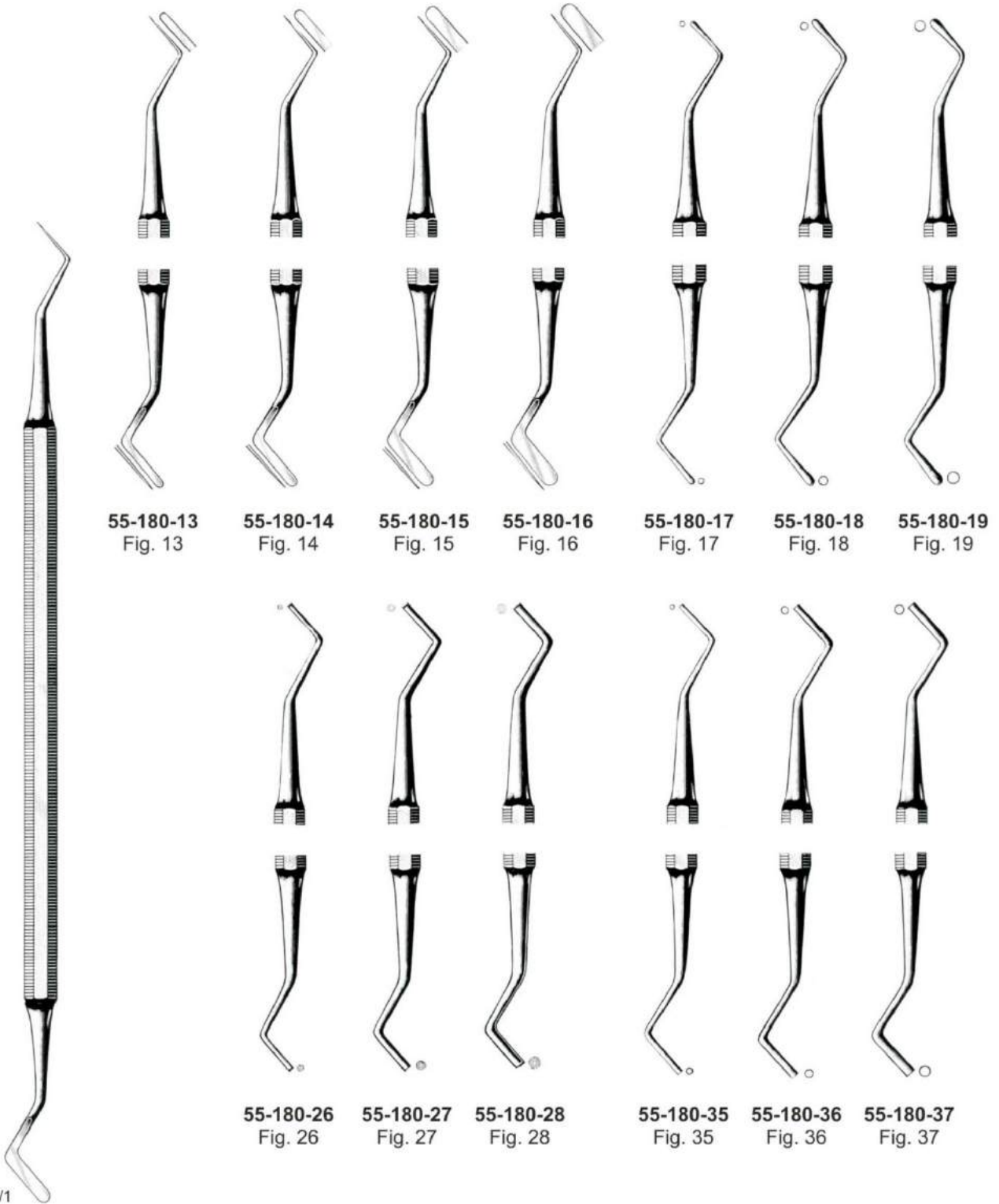

55-180-13  
Fig. 13

55-180-14  
Fig. 14

55-180-15  
Fig. 15

55-180-16  
Fig. 16

55-180-17  
Fig. 17

55-180-18  
Fig. 18

55-180-19  
Fig. 19



55-180-26  
Fig. 26

55-180-27  
Fig. 27

55-180-28  
Fig. 28

55-180-35  
Fig. 35

55-180-36  
Fig. 36

55-180-37  
Fig. 37

1/1

55-180-13  
to  
55-180-37



Cement Spatulas  
Zementspatel  
Espátulas para cemento







**Cement Spatulas, Silicate Spatulas  
Zementspatel, Silikatspatel  
Espátulas para cemento y silicato**

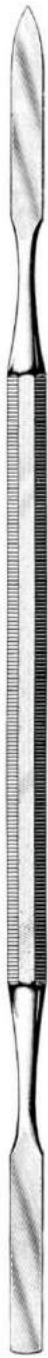

1/1



**55-194-01**  
Fig. 1



**55-194-02**  
Fig. 2



**55-194-03**  
Fig. 3



**55-198-01**

**Separators, Matrix Retainers**  
**Separatoren, Matrizenspanner**  
**Separadores, Porta-matrices**



Ivory  
**55-210-01**  
 Fig. 14

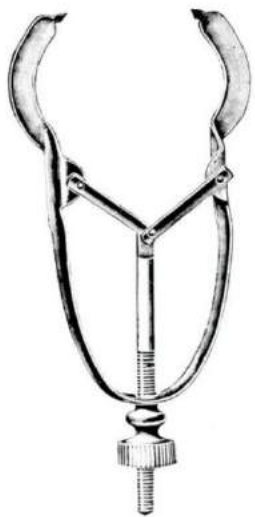

Ivory  
**55-212-01**  
 Fig. 1



Ivory  
**55-214-01**  
 Fig. 12



Ivory  
**55-214-02**  
 Fig. 12A

Matrix bands  
 for Molars



**55-218-01**  
 Fig. 1



**55-218-03**  
 Fig. 3



**55-218-05**  
 Fig. 5

Matrix bands  
 for Premolars



**55-218-02**  
 Fig. 2



**55-218-04**  
 Fig. 4



**55-218-06**  
 Fig. 6

**Matrix Retainers, Matrix Bands  
Matrizenspanner, Matrizen  
Porta-matrices, Bandas matrices**

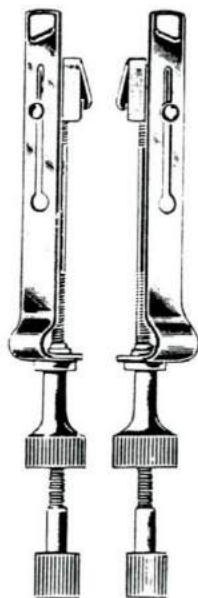

Nystroem  
55-220-00  
Pair



Nystroem  
55-220-01  
Left



Nystroem  
55-220-02  
Right



Tofflemire  
55-222-01  
Universal



Tofflemire  
55-224-01  
Fig. 1



Tofflemire  
55-224-02  
Fig. 2



Tofflemire  
55-224-03  
Fig. 3

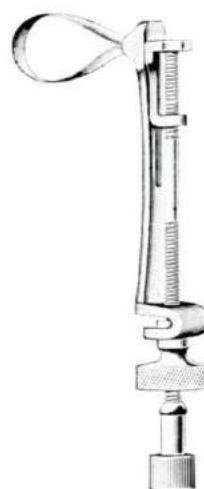

Ivory  
55-226-05 5mm  
55-226-06 6mm  
55-226-07 7mm  
Fig. 8



Ivory  
55-228-05  
Fig. 8N



**Matrix Retainers, Matrix Bands  
Matrizenspanner, Matrizen  
Porta-matrices, Bandas matrices**



**Tofflemire  
55-232-01  
Fig. 1**



**Tofflemire  
55-232-02  
Fig. 2**



**Tofflemire  
55-232-03  
Fig. 3**



**Tofflemire  
55-232-13  
Fig. 13**

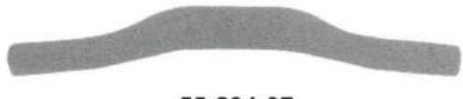

**55-234-07  
Fig. 7**



**55-234-08  
Fig. 8**



**55-234-09  
Fig. 9**



**55-234-10  
Fig. 10**



**55-234-11  
Fig. 11**



**55-234-12  
Fig. 12**



**55-234-13  
Fig. 13**

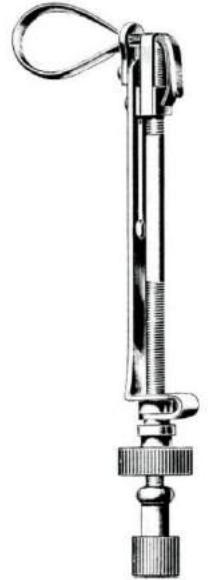

**Didner  
55-230-05  
Fig. 8P**



**55-236-05  
5mm**



**55-236-06  
6mm**



**55-236-07  
7mm**

**Rubber Dam Instruments**  
**Kofferdam-Instrumente**  
**Instrumentos para dique**

Rubber Dam Punches



**Ainsworth**  
**55-240-16**  
16 cm



**Ainsworth**  
**55-242-16**  
16 cm



**Ainsworth**  
**55-244-16**  
16 cm



**Ainsworth**  
**55-246-16**  
16 cm



**Ivory**  
**55-248-15**  
15 cm

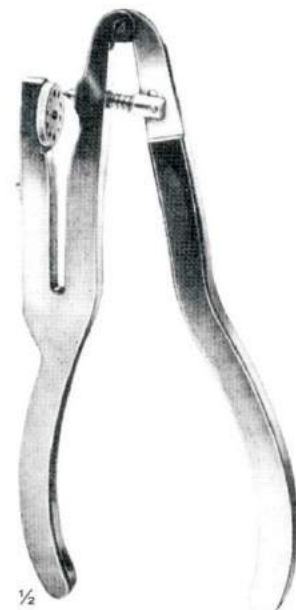

**Ivory**  
**55-250-16**  
16 cm

**Rubber Dam Instruments  
Kofferdam-Instrumente  
Instrumentos para dique**

Rubber dam clamp forceps

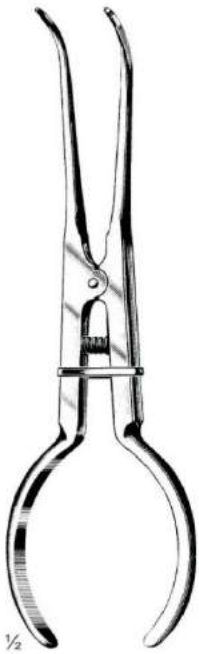

Stocker  
55-260-17  
17 cm

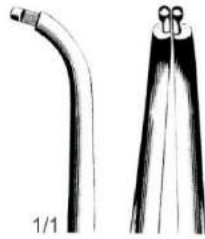

55-262-16  
16 cm

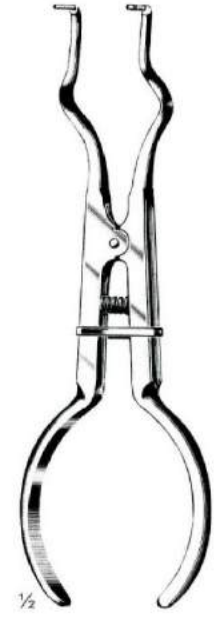

Brewer  
55-264-17  
17 cm

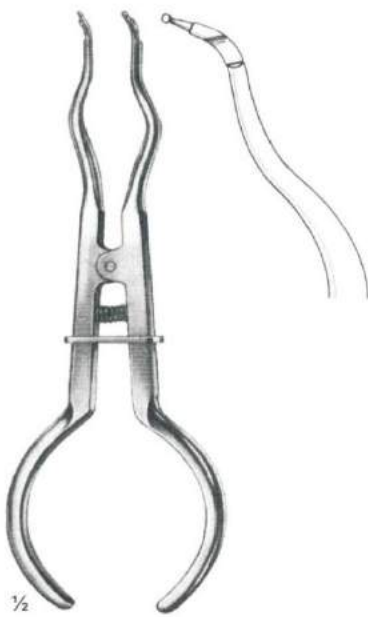

Brewer  
55-266-17  
17 cm



Stocker  
55-268-17  
17 cm

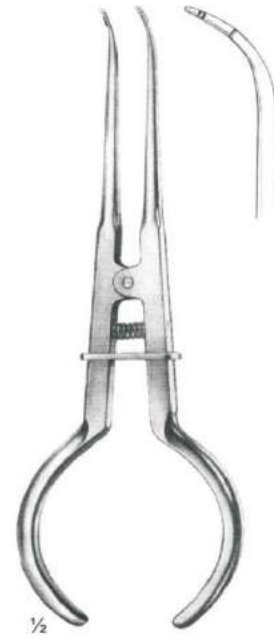

Palmer  
55-270-17  
17 cm



**Rubber Dam Instruments**  
**Kofferdam-Instrumente**  
**Instrumentos para dique**

Rubber dam clamp forceps

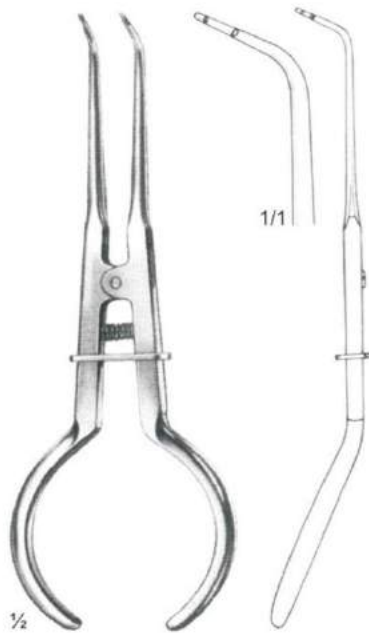

White  
**55-280-17**  
17 cm



**55-282-17**  
17 cm

**Rubber Dam Instruments  
Kofferdam-Instrumente  
Instrumentos para dique**

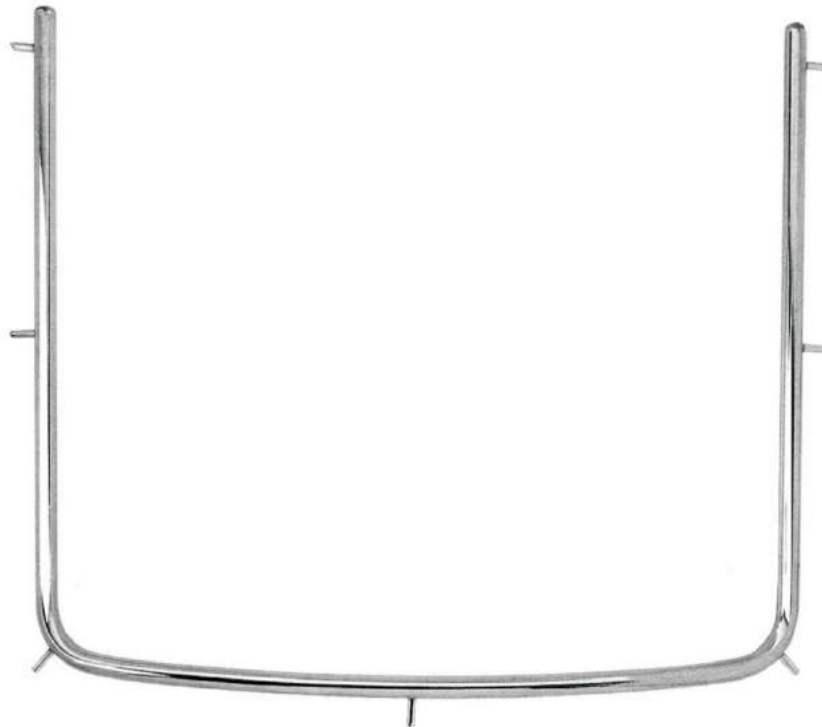

55-290-00



Ivory  
55-296-26  
Fig. 26



Ivory  
55-296-27  
Fig. 27



Ivory  
55-296-28  
Fig. 28



Ivory  
55-296-29  
Fig. 29



Ivory  
55-296-30  
Fig. 30



Ivory  
55-296-31  
Fig. 31



Ivory  
55-296-51  
Fig. 51



Ivory  
55-296-60  
Fig. 60



**Impression Trays**  
**Abdrucklöffel**  
**Cubetas para impresiones**

Stainless Steel 18/10

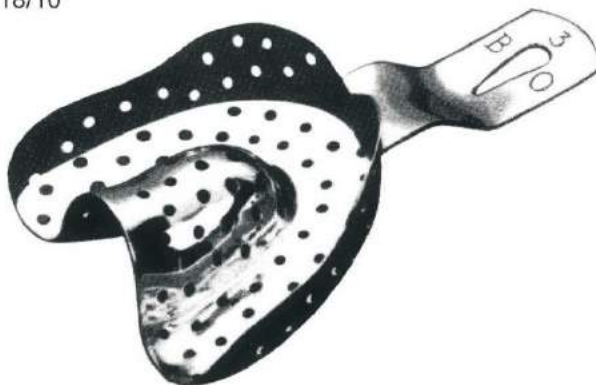

Ehrlicke 56-100-00 BO 0    Ehrlicke 56-100-01 BO 1    Ehrlicke 56-100-02 BO 2    Ehrlicke 56-100-03 BO 3    Ehrlicke 56-100-04 BO 4



Ehrlicke 56-102-01 PO 1    Ehrlicke 56-102-02 PO 2    Ehrlicke 56-102-03 PO 2



Ehrlicke 56-104-01 FO 1    Ehrlicke 56-104-02 FO 2    Ehrlicke 56-104-03 FO 3



Ehrlicke 56-106-01 UO 1    Ehrlicke 56-106-02 UO 2    Ehrlicke 56-106-03 UO 3



Ehrlicke 56-108-00 BU 0    Ehrlicke 56-108-01 BU 1    Ehrlicke 56-108-02 BU 2    Ehrlicke 56-108-03 BU 3    Ehrlicke 56-108-04 BU 4

**Impression Trays**  
**Abdrucklöffel**  
**Cubetas para impresiones**

Stainless Steel 18/10



Ehricke  
**56-110-01**  
 PU 1

Ehricke  
**56-110-02**  
 PU 2

Ehricke  
**56-110-03**  
 PU 3



Ehricke  
**56-112-01**  
 UU 1

Ehricke  
**56-112-02**  
 UU 2

Ehricke  
**56-112-03**  
 UU 3

Ehricke  
**56-112-03**  
 UU 3



**56-114-01** Fig. 1    **56-114-02** Fig. 2    **56-114-03** Fig. 3    **56-114-04** Fig. 4

Upper jaw right/Lower jaw left



**56-116-01** Fig. 1    **56-116-02** Fig. 2    **56-116-03** Fig. 3    **56-116-04** Fig. 4

Upper jaw left/Right jaw left

**Wax and Modelling Carvers**  
**Wachs und Modellierinstrumente**  
**Talladores y espátulas para cera, y para modelar**

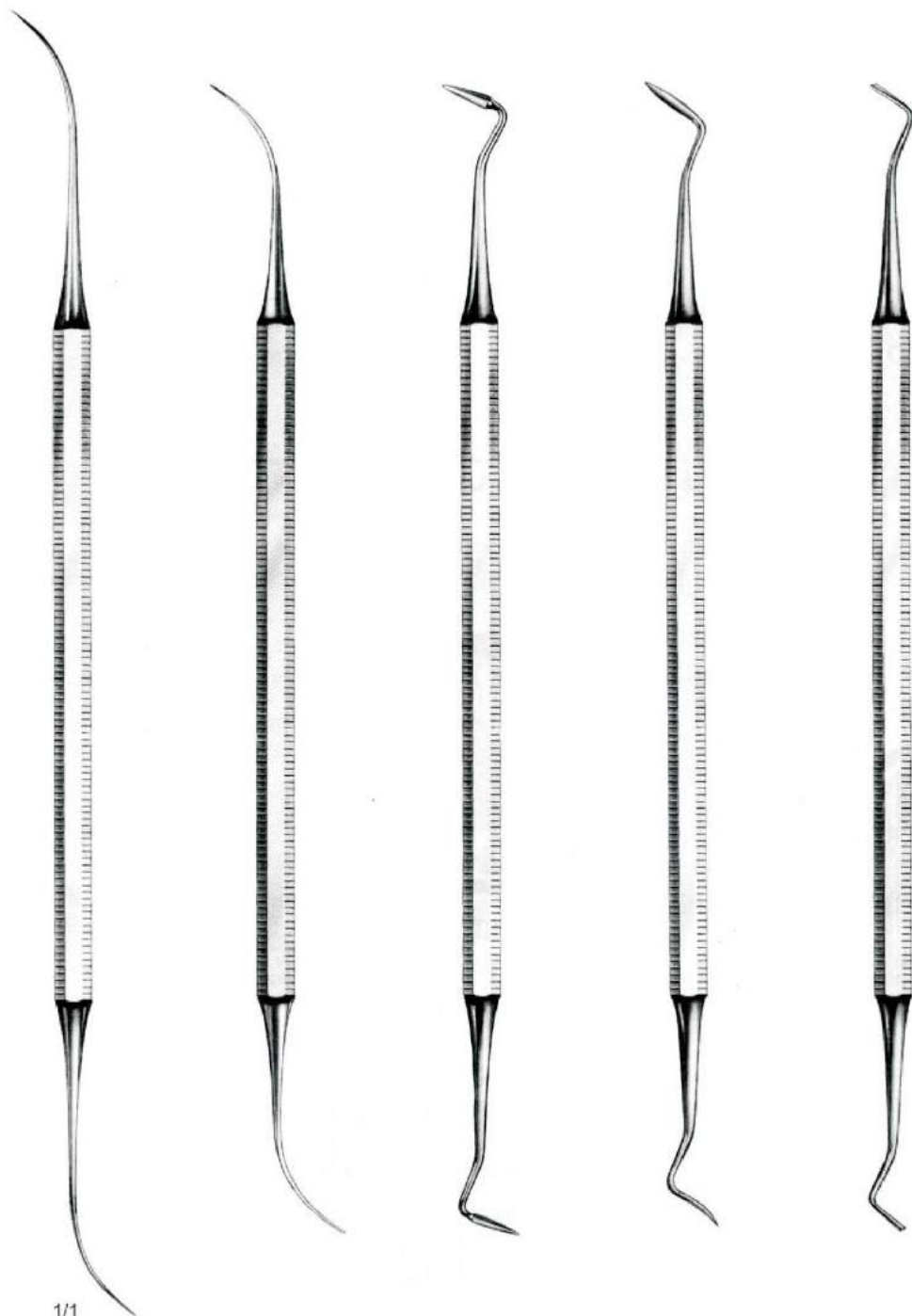

1/1  
Thomas  
56-130-01

Thomas  
56-130-02

Thomas  
56-130-03

Thomas  
56-130-04

Thomas  
56-130-05



**Wax and Modelling Carvers**  
**Wachs und Modellierinstrumente**  
**Talladores y espátulas para cera, y para modelar**



**Wax and Modelling Carvers**  
**Wachs und Modellierinstrumente**  
**Talladores y espátulas para cera, y para modelar**

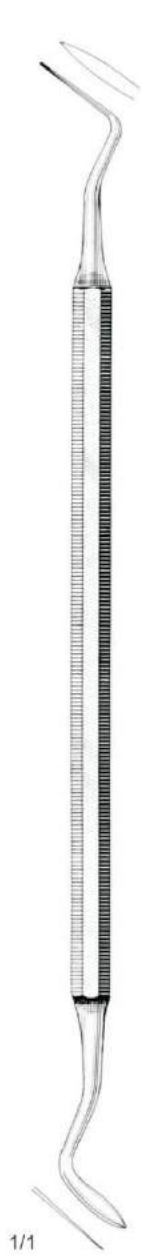

**Hollenback  
56-160-30**

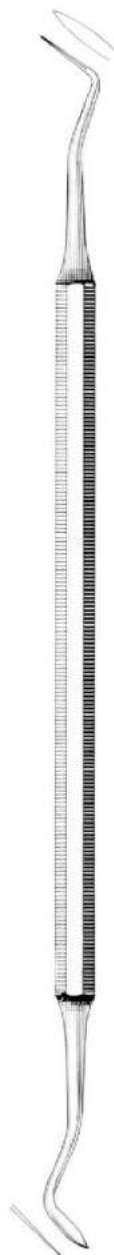

**Hollenback  
56-160-31**



**Wiland  
56-164-08  
Fig. 8**



**Interproximal  
56-168-00**



**Wax and Modelling Carvers**  
**Wachs und Modellierinstrumente**  
**Talladores y espátulas para cera, y para modelar**



Hylin  
56-160-01



Zahle  
56-162-01



Zahle  
56-164-01



Le Cron  
56-168-01



Le Cron  
56-170-01



**Wax and Modelling Carvers**  
**Wachs und Modellierinstrumente**  
**Talladores y espátulas para cera, y para modelar**



1/1  
**Ermert**  
**56-180-01**



**Beale**  
**56-184-01**  
Mod. 7A



**Gisy-Wild**  
**56-190-15**  
15 cm



**Fahnenstock**  
**56-194-13** 13 cm  
**56-194-17** 17 cm



**Antkoviak**  
**56-196-12**  
12.5 cm



**56-198-00**



**Instruments for Crown Work**  
**Kroneninstrumente**  
**Instrumentos para coronas**



1/1

**Miller**  
**56-210-15**  
 15 cm



**Sachs**  
**56-214-01**



**Mershon**  
**56-218-01**



**56-222-01**



**Mod. Paris**  
**56-230-01**



**56-240-30**  
 10 m / 32 ft.

of acrylic glass



**Instruments for Crown Work**  
**Kroneninstrumente**  
**Instrumentos para coronas**



**56-256-01 56-256-02 56-256-03 56-256-04 56-256-05**

suited for (56-252-01, 56-254-01)



**Treyemann  
56-250-01**



**Schroeder  
56-252-01**

Handle, only



**Miller  
56-254-01**

Handle, only



**Miller  
56-258-19  
19 cm**



**56-260-01**

Prosthetics, Ortodontia  
Prothetik, Orthodontie  
Prótesis, Ortodoncia

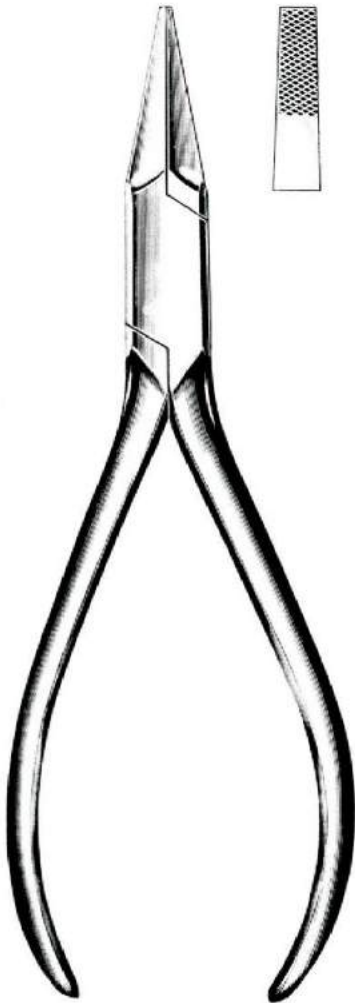

57-100-14  
14cm



Langenbeck  
57-102-14  
14cm



Langenbeck  
57-104-14  
14cm



57-106-13  
12.5cm



57-108-13  
12.5cm

**Prosthetics, Ortodontia  
Prothetik, Orthodontie  
Prótesis, Ortodoncia**

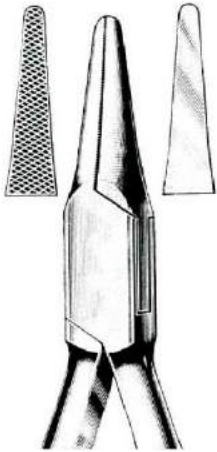

Goslee  
57-120-14  
14cm

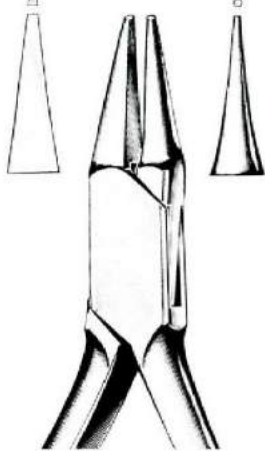

57-122-15  
15cm

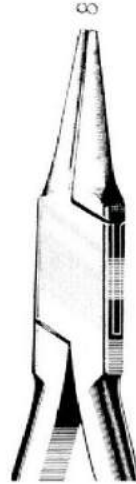

57-124-13  
13cm

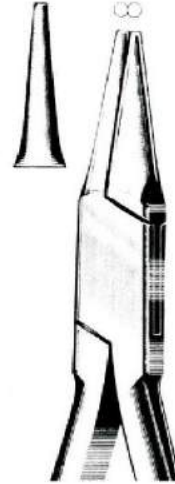

57-126-13  
13cm

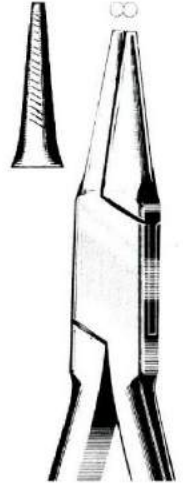

57-128-13  
13cm

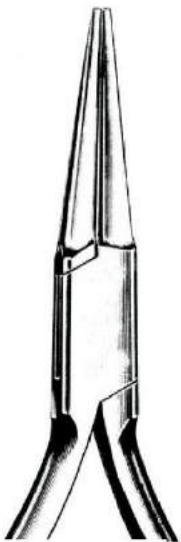

Langbeck  
57-130-14  
14cm

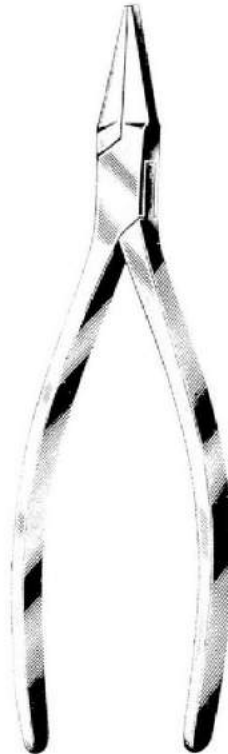

Dumont  
57-132-11 - 57-136-11

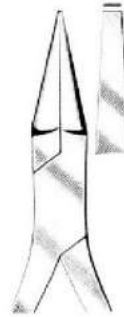

57-132-11  
11.5cm



57-134-11  
11.5cm



57-136-11  
11.5cm

Prosthetics, Ortodontia  
Prothetik, Orthodontie  
Prótesis, Ortodoncia

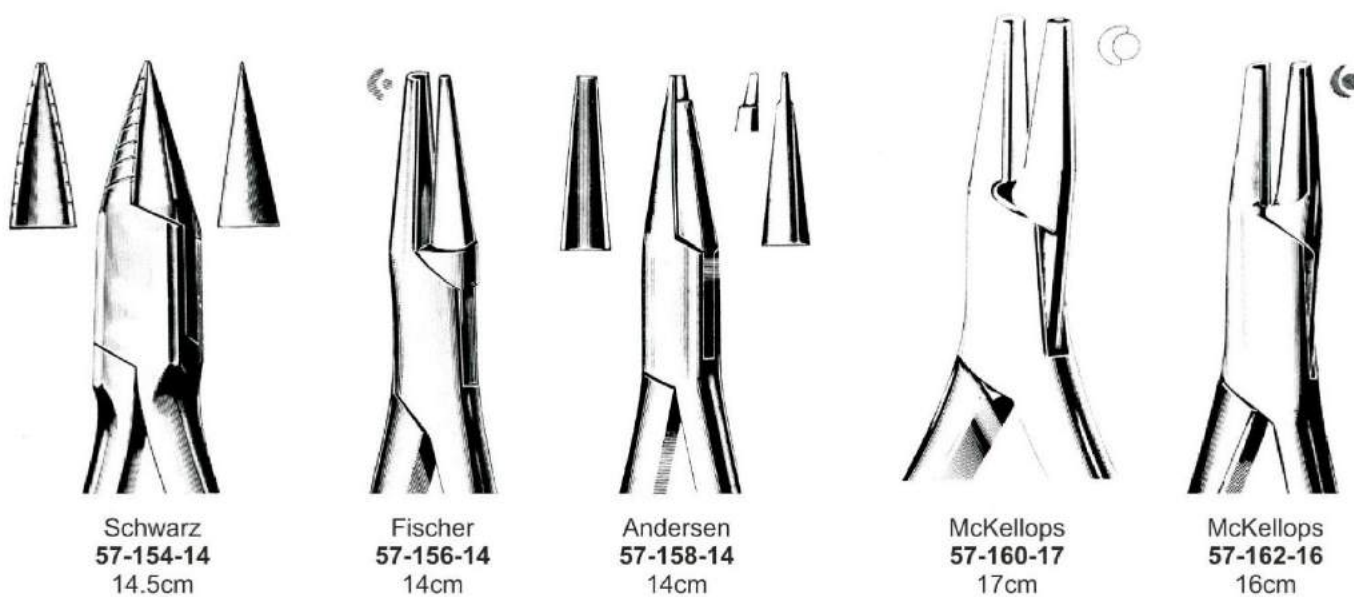
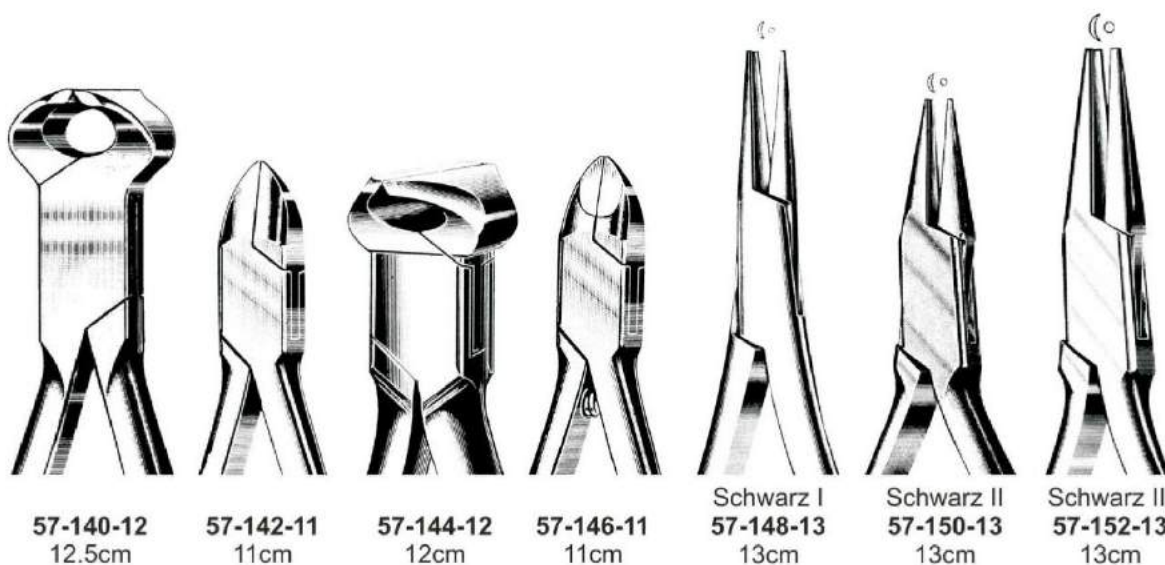

Prosthetics, Ortodontia  
Prothetik, Orthodontie  
Prótesis, Ortodoncia



Stadler  
57-170-15  
15cm

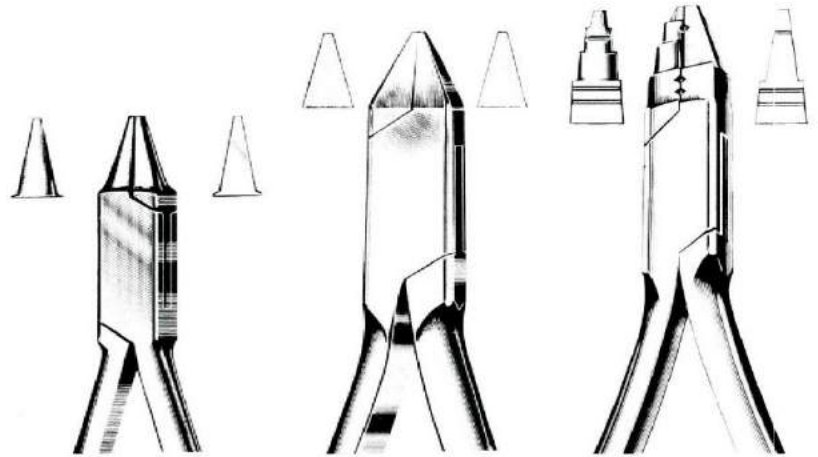

Angle  
57-172-12  
12cm

Adams  
57-174-13  
13cm

Young  
57-176-13  
13cm

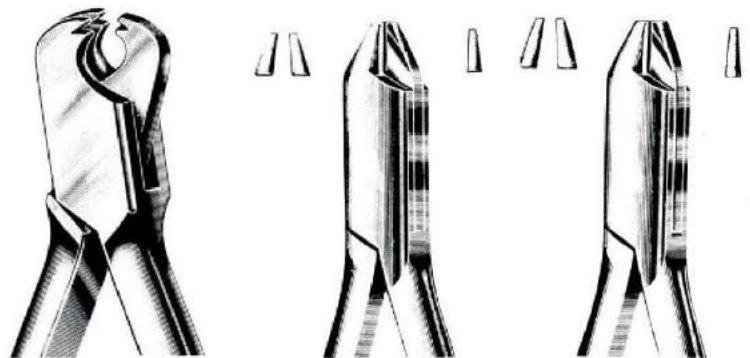

Aderer  
57-178-14  
14cm

Aderer  
57-180-12  
11.5cm

Aderer  
57-182-13  
13cm

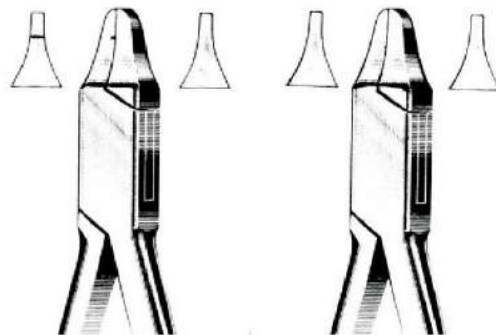

Angle  
57-184-13  
13cm

Angle  
57-186-13  
13cm

**Prosthetics, Ortodontia  
Prothetik, Orthodontie  
Prótesis, Ortodoncia**



Waldsachs-Universal  
**57-190-15**  
15.5cm

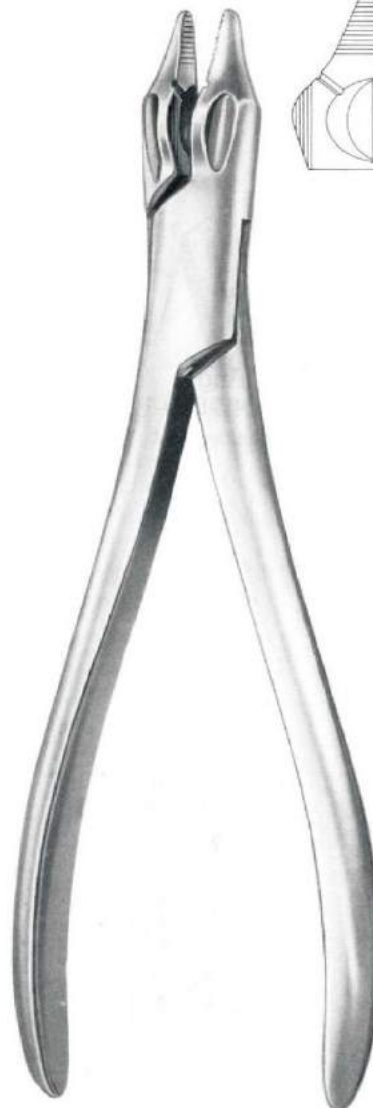

Universal  
**57-192-15**  
15.5cm

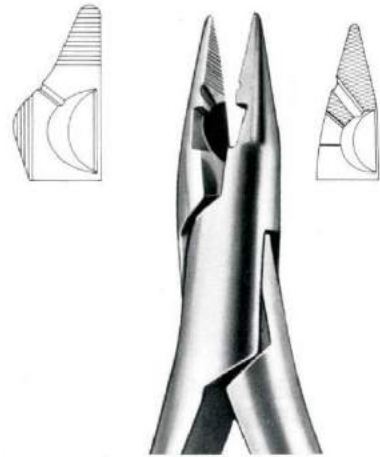

**57-194-15**  
15.5cm

Prosthetics, Ortodontia  
Prothetik, Orthodontie  
Prótesis, Ortodoncia



Furrer  
57-200-15  
15cm

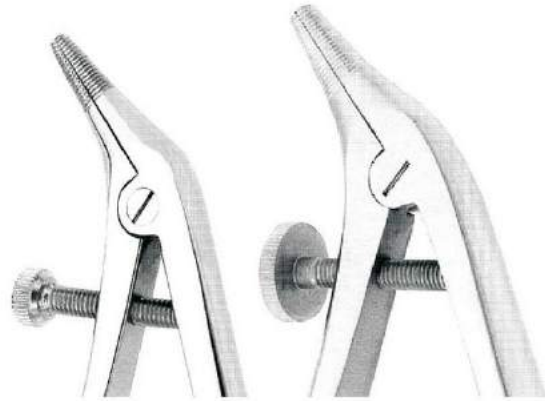

Boehm  
57-202-12  
12cm

Boehm  
57-204-15  
15cm

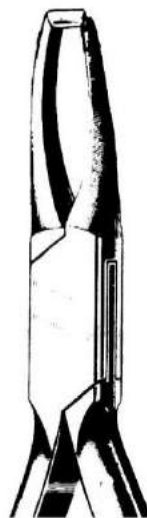

Oliver Jones  
57-206-15  
15cm



Oliver  
57-208-15  
15cm



Oliver  
57-210-15  
15cm

Prosthetics, Ortodontia  
Prothetik, Orthodontie  
Prótesis, Ortodoncia



Weingart  
57-220-14  
14cm



Korkhaus  
57-226-15  
15cm



Prosthetics, Ortodontia  
Prothetik, Orthodontie  
Prótesis, Ortodoncia



Tryfus  
57-230-16  
16.5cm

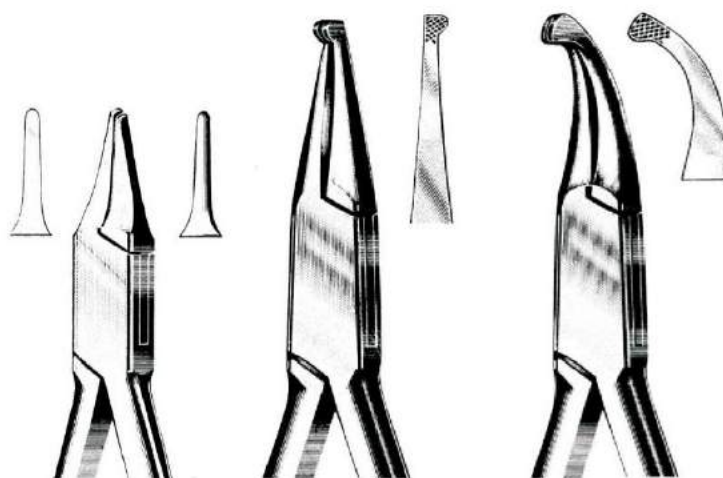

Peeso  
57-232-12  
12cm

How  
57-234-14  
14cm

How  
57-236-14  
14cm

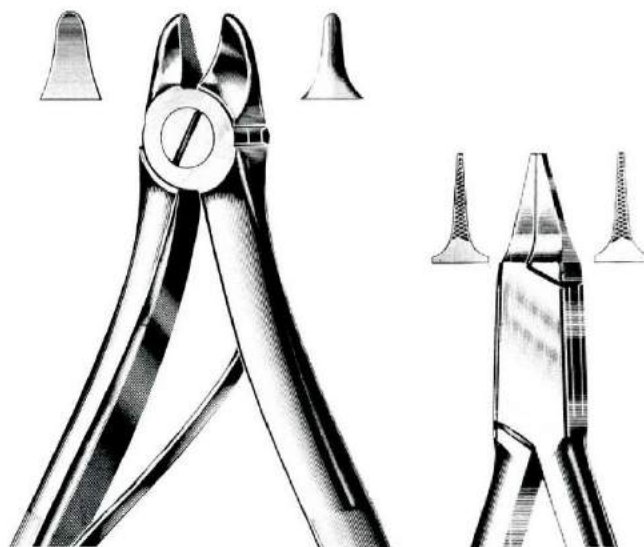

Peeso  
57-238-14  
14.5cm

Frevert  
57-240-12  
12cm

**Prosthetics, Ortodontia  
Prothetik, Orthodontie  
Prótesis, Ortodoncia**

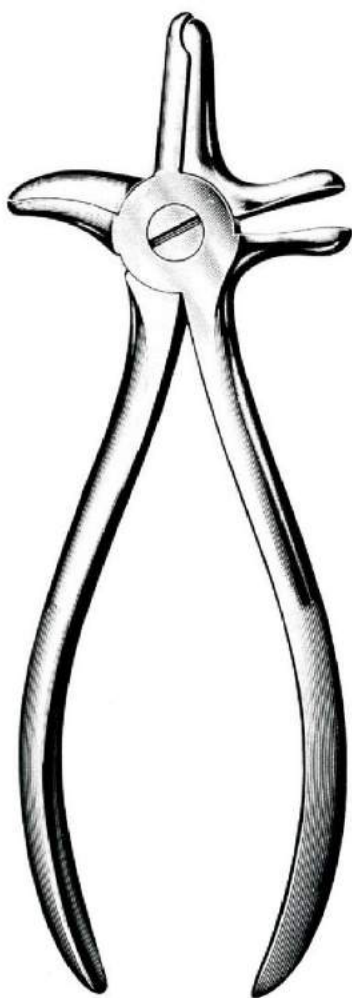

**Triplex  
57-150-14  
14cm**



**Reynold  
57-152-12  
12.5cm**

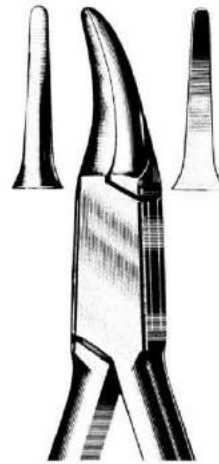

**Gordon  
57-154-14  
14cm**

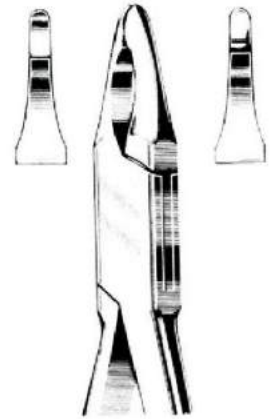

**Jhonson  
57-156-13  
13cm**

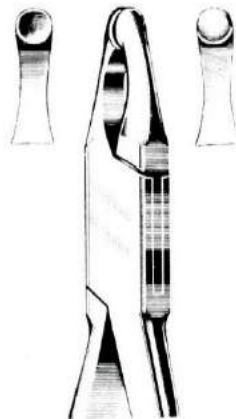

**Abell  
57-158-13  
13cm**