

VOLUME 27



STEERING COLUMNS AND RELATED ACCESSORIES



from the

STEERING COLUMN SPECIALISTS



A LETTER FROM THE IDIDIT FAMILY

ididit was founded in 1986. At that time creative car builders had to spend hours searching through wrecking yards to find the exact part they needed to build the "hot rod" of their dreams. Whether it was mechanical or visual, it always seemed to take a long time to find the perfect part for their car. And to make the search even tougher, more and more junk yards started closing their gates in the early 80's. Just as it seemed hot rodders had no resources left, there was a light at the end of the tunnel. Serious cars guys were making their own parts in their garages which was what ididit founder Ken Callison was doing in his own garage. And from these early pioneers, a new industry was born.

As we revel at the hot rod industry today, we can't help but look at our progress from 1986 to today. Ken started designing steering columns because the original GM columns that were coming out of the wrecking yards had exposed wires and were really ugly. Ken rerouted a few things and created a smooth, clean look down the column. He even made it tilt and gave it turn signals & 4 way flashers, which was just like the modern comforts of cars we were used to driving. Through these improvements, he created a more desirable steering column for the hot rod market.

Of course, over the years the ididit design was copied a few times, but as they say, "imitation is the sincerest form of flattery." However, it's easy to copy and build cheaper but it is very difficult to copy top quality. ididit steering columns remain unmatched in quality & service.

ididit has always held a vision for their employees. ***Through an environment encouraging the creative realization of products of the future, ididit produces the world's finest quality, state of the art, parts for the auto enthusiast.*** That vision was dedicated 29 years ago. Today, we continue to strive to follow our vision both with our employees and our products. We are extremely proud of the fact that throughout the years and the up & down economy we have kept our products designed and produced in the United States and made with 100% American made parts. Because of this we are and will always be proud to say "ididit."

Ken, Jane, Scott & Kimberly



INTRODUCTION

New Products	1
How To Guide & Tips	2-4
Part Number & Finish Guide.....	4

UNIVERSAL SERIES COLUMNS

“Classic” Straight.....	5
“Old School” Straight.....	6
Straight Floor Shift.....	8
Straight Column Shift.....	9
Tilt Columns.....	10-11
Tilt Column Shifts	12-13
Tilt/Telescoping	14-15
Universal “Shorty”.....	16
Steer Clear	17

Theory of a Collapsible Column	18
Collapsible Columns & Accessories.....	19
Right Hand Drive Columns	20

RETROFIT SERIES CAR COLUMNS

Quick Reference Guide	22
Individual Kit Components.....	23
1955-57 Chevy	24-25
1967-69 Camaro/Firebird	26
1970-75 Camaro.....	27
1964-72 Chevelle/El Camino/GTO	28-29
1953-68 Corvette.....	30-31
1958-67 Impala.....	32-33
1962-73 Nova.....	34-35
1964-65 Falcon.....	36

1965 Mercury Comet.....	37
1965-69 Mustang.....	38-39
1970-74 Cuda/Challenger	40
1967-69 & 73 Chrysler B-Body.....	41

RETROFIT SERIES TRUCK COLUMNS ..

1947-78 Chevy Truck	44-45
1974-1977 Bronco	46
1953-79 Ford Half-ton Truck	47-48
1976-86 Jeep CJ 5&7.....	49

GOLF CART COLUMNS

Golf Cart Columns	51
Accessories & Installation.....	52

ADD-ONS & ACCESSORIES

Floor Mounts.....	54
Column Drops.....	55
Column Add-Ons	56-57
Cable Shift Linkage Kits	58
Knobs & Levers	59
Steering Wheel Adaptors.....	60

BORGESON UNIVERSAL

Borgeson Products	61
Borgeson Box Chart	62

Frequently Asked Questions	63-64
ididit Apparel & Gifts	65
The ididit Family	66
Ordering & Shipping Info	67



Hours of Operation

EASTERN

Mon-Fri
8:30 am-5:30 pm
Saturday
10:00 am-2:00 pm

CENTRAL

Mon-Fri
7:30 am-4:30 pm
Saturday
9:00 a -1:00 pm

MOUNTAIN

Mon-Fri
6:30 am-3:30 pm
Saturday
8:00 am-12:00 pm

PACIFIC

Mon-Fri
5:30 am-2:30 pm
Saturday
7:00 am-11:00 pm

Special Summer Hours

*ididit will be closed on Saturdays
starting Memorial Day weekend thru
Labor Day weekend.*

NEW PRODUCTS THE LATEST FROM IDIDIT

Hey Ford fans! We've got 2 all new Ford Style tilt steering columns for your Falcon or Mercury Comet. They feature all Ford wiring, a Ford splined top shaft and will easily attach to your modified stock gearbox. They will even plug into your original wiring harness. Even cooler, you can bolt your original steering wheel to the column, no adaptor required.

1964&65 Ford Falcon

- 8-POSITION TILT
- FORD SPLINED TOP SHAFT
- FORD TURN SIGNAL SWITCH
- FORD STYLE KNOBS & LEVERS
- GEARBOX COVER
- LOCATING SLOTS
- MODEL SPECIFIC FLOOR MOUNT
- FLOOR SHIFT & COLUMN SHIFT

go to page 36
FOR MORE INFO!

1965 Mercury Comet

- 8-POSITION TILT
- FORD SPLINED TOP SHAFT
- FORD TURN SIGNAL SWITCH
- FORD STYLE KNOBS & LEVERS
- MODEL SPECIFIC FLOOR MOUNT
- 3/4"-.36 LOWER SHAFT
- FORD WIRING CONNECTORS

go to page 37
FOR MORE INFO!

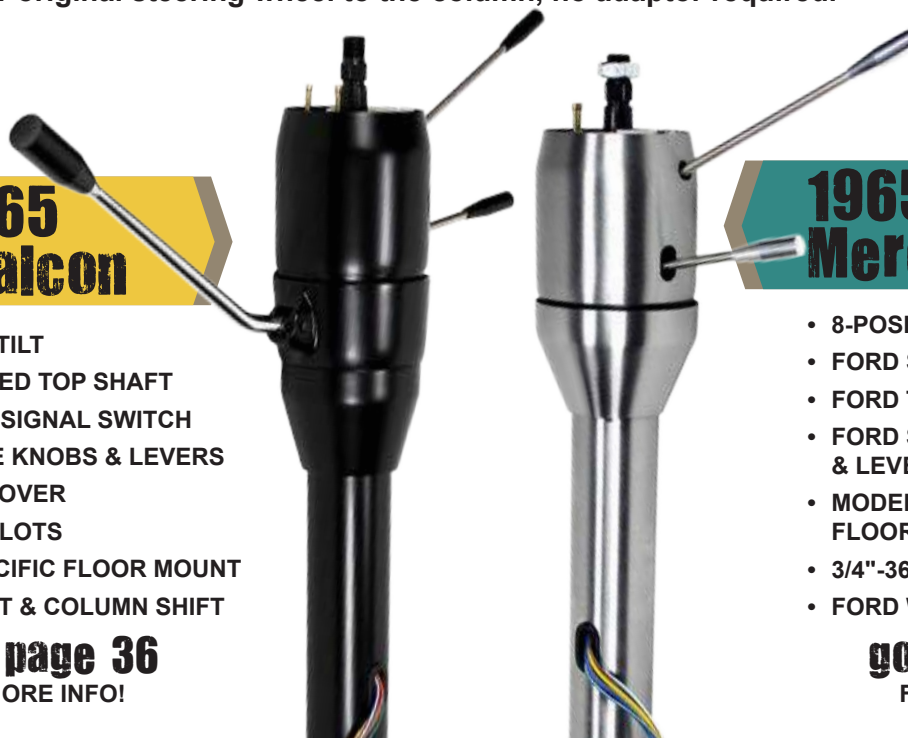

Step 1

The seat you will be using, or a good facsimile, **MUST** be in place before measuring for your new steering column. That means **NO** milk crates or lawn chairs! The steering wheel position and the pedal position all relate to the comfort of the driver. So if you want to be comfortable behind the wheel take your time and measure correctly.

Step 2

Equally important is the location of the engine, cylinder head, and headers. These components, or good mock-ups, should be in place to ensure you have proper clearance for your steering linkages.

Step 3

The position of the transmission linkage is also vital. If you do not have clearance for a solid rod style linkage kit, the use of a cable shift linkage kit may be necessary. Be sure to leave yourself two inches of space between the columns lower shift linkage and firewall.

Step 4

Center your column on the drivers seat to ensure proper alignment. If your column is installed offset or angled it may feel awkward and uncomfortable.

Step 5

Position the column/steering wheel so that your arms are relaxed and comfortable when the seat is adjusted for optimal pedal control.

Step 6

You will also need to position the column for maximum use of the tilt mechanism. It doesn't do any good to have the wheel tilted into the dash or down on the seat.

Step 7

Column drops should fit snugly and in a stable position on both the bottom of the dash and the column. No wobbles or vibration should occur.

Step 8

The lower mounts should be stable and able to fit the angle of the floor or firewall where the column will pass through (or a fixed custom built mount). This mount **MUST** be sealed tightly to prevent exhaust fumes, heat, dirt and water from entering your interior.

Step 9

If you have a floor mounted brake and/or clutch pedal assembly, make sure you have enough clearance for the column.

Step 10

Use of more than two u-joints require the use of support bearing to keep the linkage operation smooth, strong, stable and safe.

For safety purposes, ididit recommends using a splined or DD shafting instead of a welded or pinned shafting.

TECH TIP

USING A PIE TIN & DOWEL TO FIND THE PERFECT COLUMN POSITION

As silly as it may sound, we have found that using an aluminum pie tin and a wooden dowel is an excellent way to determine the column length needed and it's position. You will need a 3 foot dowel piece. Add between 1 1/2" and 3" beyond the firewall/floor if using a steering box. If you are using a rack, you can go as far as 5" into the engine compartment. Watch for clearance. First, tack the tin to the dowel (steering wheel to column), then position yourself comfortably in the drivers seat while holding the dowel system in place. Have a friend measure and mark the essential dimensions such as overall length, and the distance between the center of the column and the bottom of the dash. Don't forget to mark the point where the column will pass into the engine compartment and the center-line of the drivers body/ seat as they are also important measurements.



HOW TO... MEASURE AN IDIDIT STEERING COLUMN

Ididit measures a steering column from the top edge of the column housing (1) down to the bottom of the output shaft (2) on all columns EXCEPT for our Tilt/Telescoping columns. Tilt/Telescoping columns are measured from the top edge of the column adapter down to the end of the output shaft when the column is in a fully collapsed position (see pg 15-16 for details.) The steering wheel will take up approximately 1 1/2" above the adapter.

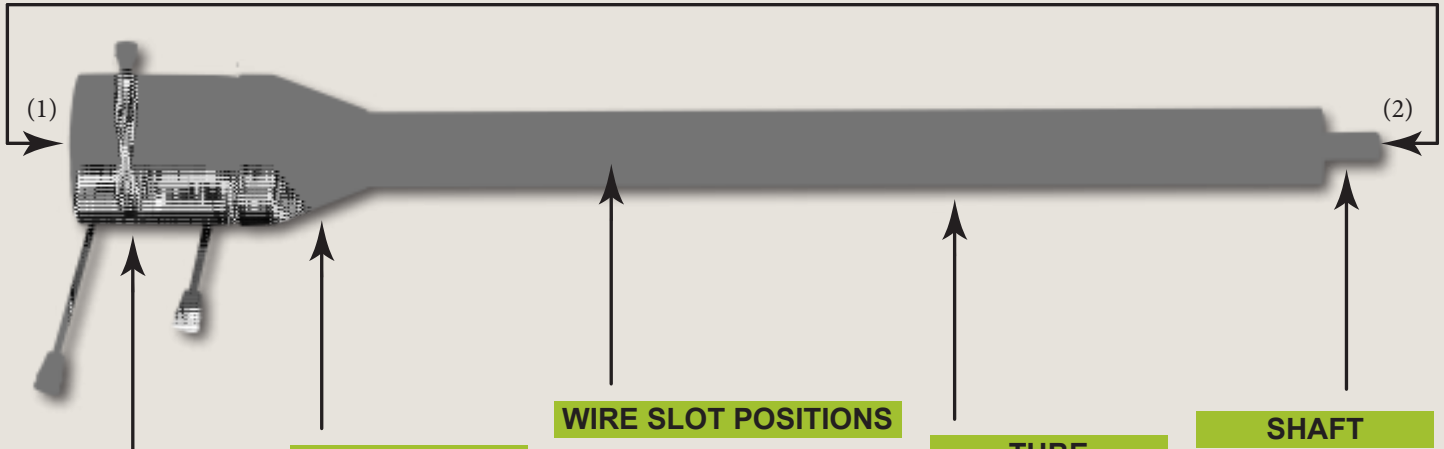

UPPER SLEEVE AND SHIFT HUB

The size of these two pieces cannot be changed. Measure 4" (floor shift) or 6 1/8" (column shift) from the top of the column and mark the position on the dowel.

Add 1/4" to represent the gap between the sleeve and the cone.

LOWER CONE

This part of the column can be customized. The standard length is 3.25" and can be shortened to 1.5" upon request (a custom charge will apply). Measure 3.25" (or custom length if applicable) from the bottom of the sleeve or shift hub and mark the dowel. *Shortened cones may expose wiring.*

WIRE SLOT POSITIONS

The position of the wire slot is important because it will determine where your underdash mount will attach to the column. On our tilt floor shift column, the standard wire slot position is 11.5" from the top of the sleeve to the top of the wire slot, at 12 o'clock. On our tilt column shift, the standard position is 13.25". The wire slot location can also be customized. The maximum is 22" from the top of the sleeve to the top of the wiring slot. Be sure to specify what position (on a clock face, i.e. 12 o'clock) you would like it to be. Measure 11.5" (or custom length if applicable) from the top of the sleeve and mark the position on the dowel.

TUBE

The tube can be made to any length, but cannot be any shorter than 4". The tube can protrude through the firewall as far as you like, or it can stop inside the vehicle like it does with our "shorty" column. In standard applications, the tube should protrude through the firewall 1-3". On column shift versions, the lower shift linkage will attach to the end of the tube. Mark the dowel where the firewall will meet the tube.

SHAFT

The standard length of the lower shaft is 1.5" and can be made to any length between 1" to 8", from the bottom of the tube. The shaft type is available as a 1" 48 spline, 1" DD, 3/4" 36 spline, or 3/4" DD (custom charges may apply). Measure 1.5" (or custom length if applicable) from the end of the tube. Mark the dowel where the shaft will end.

IF YOU NEED YOUR COLUMN CUSTOMIZED, GIVE US A CALL AND WE WILL SEND YOU OUR CUSTOM COLUMN DIAGRAM, OR GO TO OUR WEBSITE TO DOWNLOAD THE FORM. THEN YOU'LL BE ON YOUR WAY TO A COLUMN BUILT SPECIFIC FOR YOU!



TECH TIP

MEASURING FOR YOUR STEERING WHEEL - PLEASE REMEMBER THE WHEEL AND ADAPTOR WILL ADD LENGTH TO YOUR COLUMN.

Most aftermarket steering wheels will add 3-6 inches from the gripping surface of the wheel to the top of the outer housing of the steering column. Measure and mark the dowel accordingly.

HOW TO...

MEASURE AN IDIDIT COLUMN DROP

Our standard column drop uses mounting studs set 2 5/8" apart.

ididit measures column drops from the mounting surface on the bottom of the dash to the center-line of the steering column.

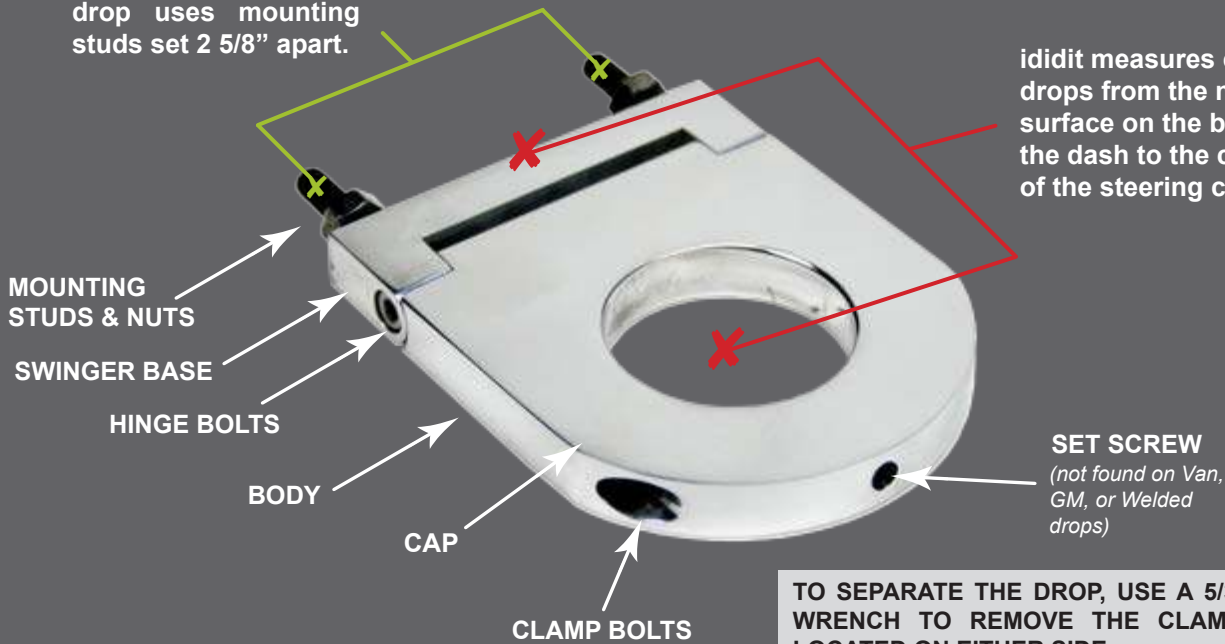

TO SEPARATE THE DROP, USE A 5/32 ALLEN WRENCH TO REMOVE THE CLAMP BOLTS LOCATED ON EITHER SIDE.



A GUIDE TO IDIDIT PART NUMBERS AND FINISHES

Our part numbers may be long, but that just means you have more options to choose from, right? Every number in our part number sequence has a specific meaning, and tells us vital information about the item you are ordering. For instance, the last two numbers of any sequence lists the finish type.

Example:
1120280020 = 28" tilt floor shift with a chrome finish

The pictures shown here are a quick reference to the finish type and their correlating part number.



10 = PAINTABLE STEEL
made from a mild steel material and can rust without proper primer and paint.



20 = CHROME
chrome plated steel for a beautiful, mirrored finish.



51 = BLACK POWDER COATED
Semi-gloss finish.



30 = BRUSHED ALUMINUM
it's clear anodized, making it practically maintenance free!



40 = POLISHED ALUMINUM
this fine quality aluminium will hold it's shine for years to come!

Universal Series

STEERING COLUMNS

- THE BENEFITS OF CHOOSING AN IDIDIT UNIVERSAL STEERING COLUMN**
- ▶ WE HAVE A WIDE ARRAY OF COLUMN TYPES TO CHOOSE FROM. MORE CHOICES TO FIT YOUR STYLE!
 - ▶ WE OFFER SEVERAL SIZES TO ENSURE THE PERFECT FIT.
 - ▶ CUSTOM SIZES ARE AVAILABLE FOR THAT TRULY CUSTOM PROJECT.
 - ▶ WE'VE GOT OPTIONS! ADD CRUISE CONTROL, DIMMER OR WIPERS FOR ADDED CONVENIENCE



Straight



Classic pg 6



Old School pg 7



Straight Floor Shift pg 8



Straight Column Shift pg 9



Tilt



Tilt Floor Shift pg 10



Tilt Column Shift pg 12



Shorty pg 16

Tilt & Tele



Tilt/Tele Floor Shift pg 14



Tilt/Tele Column Shift pg 15

ididit Universal Series steering columns can be easily installed in your street rod, hot rod, kit car or any application you see fit. ididit customers are continuously pushing the boundaries of where our Universal Series columns can go, while adding performance, style and function. Because of the endless possibilities, our Straight and Tilt Universal columns are sold by length rather than by application. The most important factor to consider when measuring for a universal steering column is driver comfort and functionality. In this catalog, we provide you with all the necessary information you'll need to correctly measure and install your ididit steering column. Use the detailed drawings and column specifications on the following pages to help you determine the critical measurements for your application, and any customizing that you may need to make. In all cases, planning ahead will greatly increase the success of your project.



Classic Straight

UNIVERSAL series

CLASSIC STRAIGHT FLOOR SHIFT

Ididit's Classic straight steering column has that great vintage look and will help add style and class to your ride! This straight column features a sleek, stylish head and a slim tube diameter. Self-canceling turn signals, 4-way flashers, horn wiring and our standard dress-up kit are included with this column.

SPECIFICATIONS

- TUBE DIAMETER: 1 3/4"
- 16" SHORTY: 3/4" DD LOWER SHAFT
REGULAR LENGTH STEEL: 3/4"-36 LOWER SHAFT
- ACCEPTS 1969 OR NEWER GM PASSENGER CAR STEERING WHEELS & ADAPTORS
- 3 7/8" GM STYLE WIRING PLUG
- ALL IDIDIT STEERING WHEEL ADAPTORS WILL FIT THIS COLUMN
- CUSTOM LENGTHS ARE AVAILABLE

	Paintable Steel	Chrome	Black Powder Coated
16"	1011160010	1011160020	1011160051
28"	1011280010	1011280020	1011280051
30"	1011300010	1011300020	1011300051
32"	1011320010	1011320020	1011320051
35"	1011350010	1011350020	1011350051

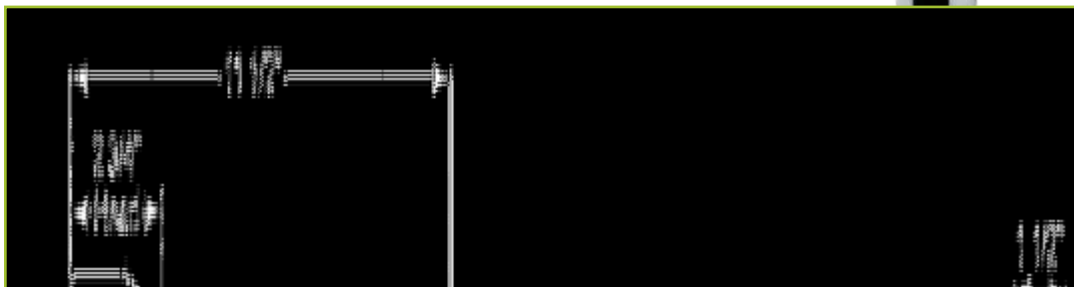

Old School Straight

UNIVERSAL series



OLD SCHOOL STRAIGHT

ididit's Old School straight column is our debut do-it-yourself column. This is the economical choice if you are looking for that special, custom fit for your Hot Rod. This small, sleek, uniquely designed column comes as a standard length of 36" but, you can cut it down with ease, to any length desired (as short as 6".) The head and tubing are made from a mild steel or stainless steel material and can be cut with a saw or cutoff wheel. Bolt your favorite 3-bolt wheel directly onto the column, no adaptor required!

	Paintable Steel	Polished Stainless Steel
36"	1012360010	1012360025

SPECIFICATIONS

- TUBE DIAMETER: 1 1/2"
- FULL LENGTH 3/4"DD LOWER SHAFT
- ACCEPTS ANY 3-BOLT WHEEL (NO ADAPTOR REQUIRED)
- COLUMN PACKAGE INCLUDES:



COLUMN TUBE

COLUMN SHAFT & 3-BOLT STEERING WHEEL ADAPTOR

2 BEARINGS

2 BEARING SEATING TOOLS

WAVY WASHER

LOCKING COLLAR

"OLD SCHOOL" ACCESSORIES

Safely secure your Old School column with these specially designed floor & dash mounts. Need a horn? A simple to install, do-it-yourself horn kit is available for your honking needs.



OLD SCHOOL HORN KIT

Part # 2612100340
Kit comes complete with horn plunger, brass sleeve w/ delrin end caps and a horn kit w/ button.

UNDERDASH MOUNTS

Available in 4 lengths
 2 1/2" Part # 2302680010
 3 1/2" Part # 2303680010
 5 1/2" Part # 2305680010
 6 1/2" Part # 2306680010



COLLAPSIBLE FLOOR MOUNT

Part # 2401110010



COLLAPSIBLE FLOOR MOUNT WITH PLATE

Part # 2401120010
The plate allows you to cover any holes in the firewall left behind by the existing steering column. Trim to fit.



Straight

UNIVERSAL series

STRAIGHT FLOOR SHIFT

ididit's simple, yet handsome Universal Straight Series columns are similar to factory columns, but are much cleaner in design. The column head is shorter in length compared to our tilt version, making this column smaller, yet completely functional. By requiring less space, you can fit this column into the smallest of driving compartments. Self-canceling turn signals, 4-way flashers, horn wiring and our standard dress-up kit are also included with this column.

SPECIFICATIONS

- TUBE DIAMETER: 2"
- 16" SHORTY: 3/4"DD LOWER SHAFT
REGULAR LENGTH STEEL: 1"DD LOWER SHAFT
- ACCEPTS 1969 OR NEWER GM PASSENGER CAR STEERING WHEELS & ADAPTORS
- 3 7/8" GM STYLE WIRING PLUG
- CUSTOM LENGTHS ARE AVAILABLE

	Paintable Steel	Chrome	Black Powder Coated
16"	1010160010	1010160020	1010160051
28"	1010280010	1010280020	1010280051
30"	1010300010	1010300020	1010300051
32"	1010320010	1010320020	1010320051
35"	1010350010	1010350020	1010350051

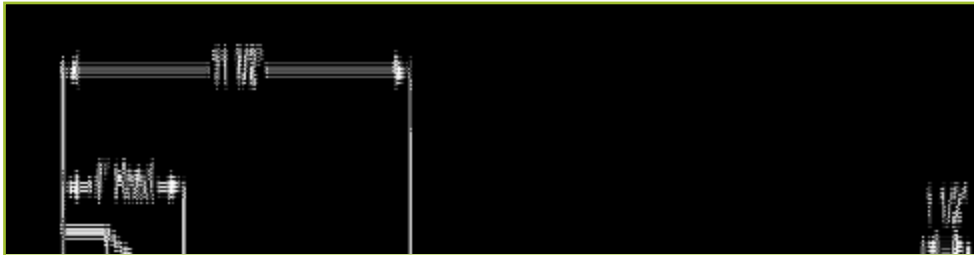

ALUMINUM STRAIGHT FLOOR SHIFT

Want aluminum? ididit has what you need! Our Aluminum Straight column offers you the same space saving features as the steel straight, but comes with a 1 3/4 inch tube diameter. Includes self-canceling turn signals, four-way flashers, horn wiring and our standard dress-up kit. Available in brushed or polished aluminum finishes. The brushed finish is clear anodized, making it practically maintenance free!

SPECIFICATIONS

- TUBE DIAMETER: 1 3/4"
- 16" SHORTY: 3/4"DD LOWER SHAFT
REGULAR LENGTH: 1"-48 LOWER SHAFT
- ACCEPTS 1969 OR NEWER GM PASSENGER CAR STEERING WHEELS & ADAPTORS
- 3 7/8" GM STYLE WIRING PLUG
- CUSTOM LENGTHS ARE AVAILABLE

	Brushed Aluminum	Polished Aluminum
16"	1020160030	1020160040
28"	1020280030	1020280040
30"	1020300030	1020300040
32"	1020320030	1020320040
35"	1020350030	1020350040





STRAIGHT COLUMN SHIFT

If a tilt column takes up too much space in your car and a column shift is a must, then our Straight Column Shift column is the perfect fit! By removing the tilt portion, the head of this column is a full two inches shorter than our standard tilt column shift. This column features a removable, indexable lower shift arm, with 12 possible positions. Self-canceling turn signals, 4-way flashers, horn wiring and our standard dress-up kit are also included. Will work with GM, Ford & Chrysler 3 or 4 speed automatic transmissions.



12 POSITION
LOWER SHIFT ARM

SPECIFICATIONS

- TUBE DIAMETER: 2 1/4"
- 18" SHORTY: 3/4"DD LOWER SHAFT
REGULAR LENGTH: 1"DD LOWER SHAFT
- ACCEPTS 1969 OR NEWER GM PASSENGER CAR STEERING WHEELS & ADAPTORS
- 3 7/8" GM STYLE WIRING PLUG
- CUSTOM LENGTHS AND OPTIONAL NEUTRAL SAFETY SWITCH ARE AVAILABLE
- PLEASE NOTE: THIS COLUMN DOES **NOT** COME WITH A NEUTRAL SAFETY SWITCH. IF YOU HAVE A TRANSMISSION MOUNTED SWITCH, A NEUTRAL SAFETY SWITCH ON THE COLUMN IS NOT NEEDED.

	Paintable Steel	Chrome	Black Powder Coated
18"	1160180010	1160180020	1160180051
28"	1160280010	1160280020	1160280051
30"	1160300010	1160300020	1160300051
33"	1160330010	1160330020	1160330051
35"	1160350010	1160350020	1160350051

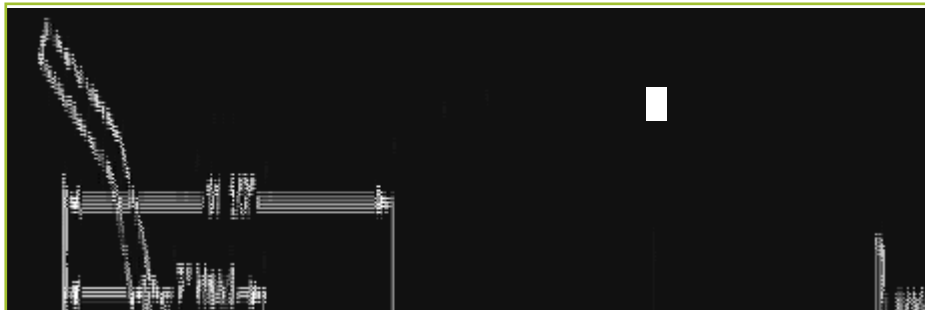

TECH TIP

IF YOU WOULD LIKE TO ADD A NEUTRAL SAFETY SWITCH TO YOUR COLUMN, THE LOCATION OF THE SWITCH MUST BE DETERMINED BEFORE PURCHASING THE COLUMN. ADDITIONAL CHARGES WILL APPLY.



Tilt Floor Shift

UNIVERSAL series

TILT FLOOR SHIFT

ididit Universal Tilt Series columns are by far our most popular steering columns and are an industry standard. Our tilt column features our unique 8-position tilt, which cannot be found anywhere else on the market. Self-canceling turn signals, 4-way flashers, horn wiring and our standard dress-up kit are also included with this column.



	Paintable Steel	Chrome	Black Powder Coated
12"	1120120010	1120120020	1120120051
16"	1120160010	1120160020	1120160051
28"	1120280010	1120280020	1120280051
30"	1120300010	1120300020	1120300051
32"	1120320010	1120320020	1120320051
35"	1120350010	1120350020	1120350051

SPECIFICATIONS

- TUBE DIAMETER: 2"
- 12" & 16" SHORTY: 3/4"DD LOWER SHAFT
REGULAR LENGTH STEEL: 1"DD LOWER SHAFT
- ACCEPTS 1969 OR NEWER GM PASSENGER CAR STEERING WHEELS & ADAPTORS
- 3 7/8" GM STYLE WIRING PLUG
- CUSTOM LENGTHS ARE AVAILABLE

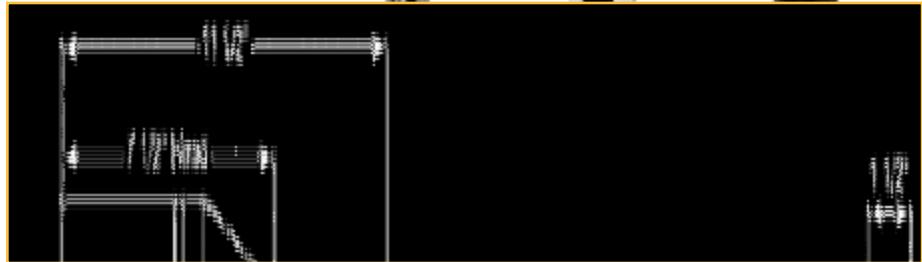

ADD KEY OR TOUCH-N-GO START IGNITION

Add style and function to your tilt steering column with ididit's key ignition. Our ignition system includes an "easy effort" electric ignition switch, relays and two coded keys. ididit ignition columns have an electric internal ignition, therefore there are no external ignition components bolted to the exterior of your column.

ididit's Touch-N-Go Start keyless ignition system comes complete with a control box small enough to fit just about anywhere, two programmable key FOB's and an adjustable range up to 15 feet (see page 58 for more details).



	Paintable Steel Key Ignition	Paintable Steel Touch-N-Go	Chrome Key Ignition	Chrome Touch-N-Go	Black Powder Coated Key Ignition	Black Powder Coated Touch-N-Go
12"	1520120010	1526120010	1520120020	1526120020	1520120051	1526120051
16"	1520160010	1526160010	1520160020	1526160020	1520160051	1526160051
28"	1520280010	1526280010	1520280020	1526280020	1520280051	1526280051
30"	1520300010	1526300010	1520300020	1526300020	1520300051	1526300051
32"	1520320010	1526320010	1520320020	1526320020	1520320051	1526320051
35"	1520350010	1526350010	1520350020	1526350020	1520350051	1526350051

ALUMINUM TILT FLOOR SHIFT

If aluminum is what you crave, then ididit has your fix! Our Aluminum Tilt column offers you the added comfort of our 8-position tilt as well as self-canceling turn signals, four-way flashers, horn wiring and our standard dress-up kit. Available in brushed or polished aluminum finishes. The brushed finish is clear anodized, making it practically maintenance free!

SPECIFICATIONS

- TUBE DIAMETER: 2 1/4"
- 12" & 16" SHORTY: 3/4"DD LOWER SHAFT
REGULAR LENGTH: 1"-48 LOWER SHAFT
- ACCEPTS 1969 OR NEWER GM PASSENGER CAR STEERING WHEELS & ADAPTORS
- 3 7/8" GM STYLE WIRING PLUG
- CUSTOM LENGTHS ARE AVAILABLE
- IGNITION SWITCH IS NOT AVAILABLE WITH ALUMINUM COLUMNS

	Brushed Aluminum	Polished Aluminum
12"	1030120030	1030120040
16"	1030160030	1030160040
28"	1030280030	1030280040
30"	1030300030	1030300040
32"	1030320030	1030320040
35"	1030350030	1030350040



Tilt Column Shift

UNIVERSAL series

TILT COLUMN SHIFT

The ididit Universal Tilt Column Shift column was the first on the market to feature a removable, indexable lower shift arm. With 12 possible positions, adjustability is just a turn of a wrench away! Our unique 8-position tilt, self-canceling turn signals, 4-way flashers, horn wiring and our standard dress-up kit are also included with this column. Will work with GM, Ford & Chrysler 3 or 4 speed automatic transmissions.



	Paintable Steel	Chrome	Black Powder Coated
18"	1130180010	1130180020	1130180051
28"	1130280010	1130280020	1130280051
30"	1130300010	1130300020	1130300051
33"	1130330010	1130330020	1130330051
35"	1130350010	1130350020	1130350051

SPECIFICATIONS

- TUBE DIAMETER: 2 1/4"
- 18" SHORTY: 3/4"DD LOWER SHAFT
REGULAR LENGTH STEEL: 1"DD LOWER SHAFT
- ACCEPTS 1969 OR NEWER GM PASSENGER CAR STEERING WHEELS & ADAPTORS
- 3 7/8" GM STYLE WIRING PLUG
- CUSTOM LENGTHS AND OPTIONAL NEUTRAL SAFETY SWITCH ARE AVAILABLE
- PLEASE NOTE: THIS COLUMN DOES NOT COME WITH A NEUTRAL SAFETY SWITCH. IF YOU HAVE A TRANSMISSION MOUNTED SWITCH, A NEUTRAL SAFETY SWITCH ON THE COLUMN IS NOT NEEDED.

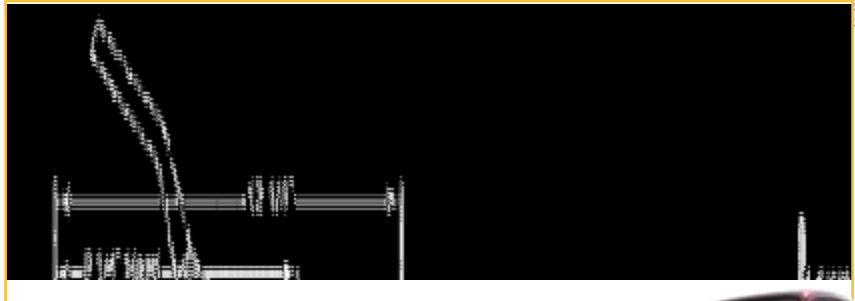

ADD KEY OR TOUCH-N-GO START IGNITION

Add style and function to your tilt steering column with ididit's key ignition. Our ignition system includes an "easy effort" electric ignition switch, relays and two coded keys. ididit ignition columns have an electric internal ignition, therefore there are no external ignition components bolted to the exterior of your column.

ididit's Touch-N-Go Start keyless ignition system comes complete with a control box small enough to fit just about anywhere, two programmable key FOB's and an adjustable range up to 15 feet (see page 58 for more details).



	Paintable Steel Key Ignition	Paintable Steel Touch-N-Go	Chrome Key Ignition	Chrome Touch-N-Go	Black Powder Coated Key Ignition	Black Powder Coated Touch-N-Go
18"	1530180010	1536180010	1530180020	1536180020	1530180051	1536180051
28"	1530280010	1536280010	1530280020	1536280020	1530280051	1536280051
30"	1530300010	1536300010	1530300020	1536300020	1530300051	1536300051
33"	1530330010	1536330010	1530330020	1536330020	1530330051	1536330051
35"	1530350010	1536350010	1530350020	1536350020	1530350051	1536350051



ALUMINUM TILT COLUMN SHIFT

Get that high tech, aluminum look with ididit's Aluminum Tilt Column Shift! This great column offers you the added comfort of our 8-position tilt as well as self-canceling turn signals, four-way flashers, horn wiring and our standard dress-up kit. Like our steel version, the removable, indexable lower shift arm comes standard. Available in brushed or polished aluminum finishes. The brushed finish is clear anodized, making it practically maintenance free! Will work with GM, Ford & Chrysler 3 or 4 speed automatic transmissions.

SPECIFICATIONS

- TUBE DIAMETER: 2 1/4"
- 18" SHORTY: 3/4"DD LOWER SHAFT
REGULAR LENGTH: 1"-48 LOWER SHAFT
- ACCEPTS 1969 OR NEWER GM PASSENGER CAR STEERING WHEELS & ADAPTORS
- 3 7/8" GM STYLE WIRING PLUG
- CUSTOM LENGTHS AND OPTIONAL NEUTRAL SAFETY SWITCH ARE AVAILABLE
- IGNITION SWITCH IS NOT AVAILABLE WITH ALUMINUM COLUMNS
- PLEASE NOTE: THIS COLUMN DOES **NOT** COME WITH A NEUTRAL SAFETY SWITCH. IF YOU HAVE A TRANSMISSION MOUNTED SWITCH, A NEUTRAL SAFETY SWITCH ON THE COLUMN IS NOT NEEDED.

	Brushed Aluminum	Polished Aluminum
18"	1050180030	1050180040
28"	1050280030	1050280040
30"	1050300030	1050300040
33"	1050330030	1050330040
35"	1050350030	1050350040

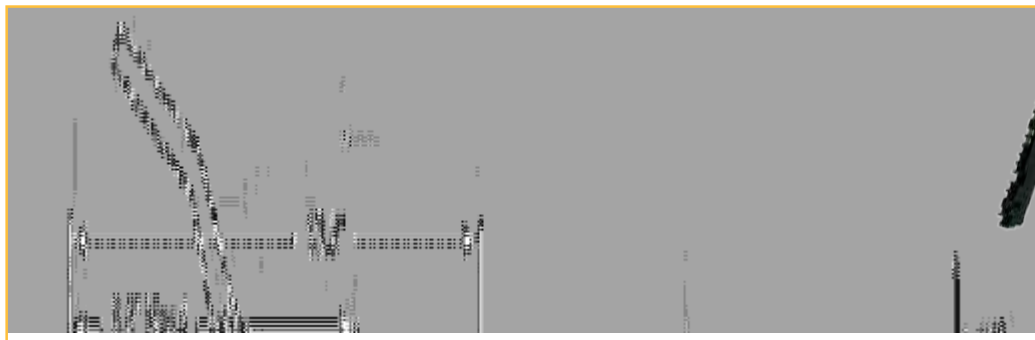

12 POSITION
LOWER SHIFT ARM

TECH TIP

IF YOU WOULD LIKE TO ADD A NEUTRAL SAFETY SWITCH TO YOUR COLUMN, THE LOCATION OF THE SWITCH MUST BE DETERMINED BEFORE PURCHASING THE COLUMN. ADDITIONAL CHARGES WILL APPLY.

Tilt & Telescoping

UNIVERSAL series

TILT & TELESCOPING FLOOR SHIFT

Our Tilt and Telescoping column is one of the most unique and luxurious steering columns that ididit offers. The top head of the column has a built-in, locking wheel adaptor and when turned, allows you to move the steering wheel 1 1-2 inches in or out. 9-bolt, 6-bolt, and 5-bolt adaptors are available for this column and must be specified when ordering. The adaptor is an integral part of the column and must be included in the measurement. Please refer to the Tilt/Tele Conversion Chart (below) to determine the proper column size. This column also features our unique 8-position tilt, self-canceling turn signals, 4-way flashers, horn wiring and our standard dress-up kit.



TILT / TELE CONVERSION CHART (Adaptor included in measurement)

16" Tilt Column =	19 1/4" Tilt/Tele Column
28" Tilt Column =	31 1/4" Tilt/Tele Column
30" Tilt Column =	33 1/4" Tilt/Tele Column
32" Tilt Column =	35 1/4" Tilt/Tele Column
35" Tilt Column =	38 1/4" Tilt/Tele Column

SPECIFICATIONS

- TUBE DIAMETER: STEEL: 2"
ALUMINUM: 2 1/4"
- 19 1/4" SHORTY: 3/4"DD LOWER SHAFT
REGULAR LENGTH STEEL: 1"DD LOWER SHAFT
REGULAR LENGTH ALUMINUM: 1"-48 LOWER SHAFT
- STEERING WHEEL ADAPTOR BOLT PATTERNS:
5-BOLT, 6-BOLT, OR 9-BOLT
- 3 7/8" GM STYLE WIRING PLUG
- CUSTOM LENGTHS ARE AVAILABLE
- ALL MEASUREMENTS ARE IN A COLLAPSED POSITION, THE COLUMN WILL TELESCOPE 1 1/2" TOWARDS THE DRIVER

9-BOLT PART NUMBERS

	Paintable Steel	Chrome	Black Powder Coated	Brushed Aluminum	Polished Aluminum
19 1/4"	1180160010	1180160020	1180160051	1040160030	1040160040
31 1/4"	1180280010	1180280020	1180280051	1040280030	1040280040
33 1/4"	1180300010	1180300020	1180300051	1040300030	1040300040
35 1/4"	1180320010	1180320020	1180320051	1040320030	1040320040
38 1/4"	1180350010	1180350020	1180350051	1040350030	1040350040

The above part numbers are for the Tilt/Tele column with a 9-bolt adaptor. Call us or refer to the price list for part numbers for columns with 5 or 6-bolt adaptors.

IGNITION OPTIONS

Keyed or Touch-N-Go Start keyless ignition are only available in steel, chrome or black powder coated Tilt & Telescoping columns.

Go to www.ididitinc.com for part numbers

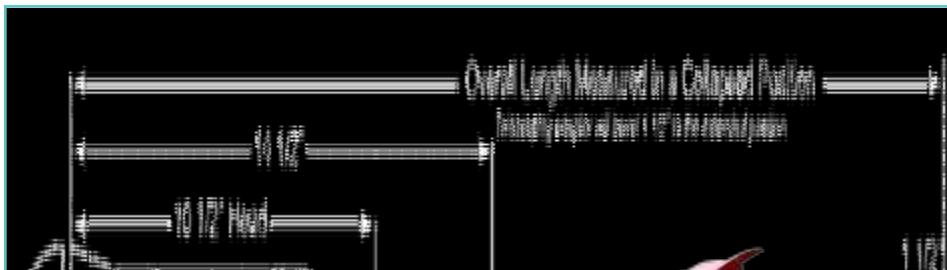

TILT & TELESCOPING COLUMN SHIFT

Our top of the line Tilt and Telescoping column shift has all the same great features as the floor shift, and includes a removable, indexable lower shift arm. With 12 possible positions, adjustability is just a turn of a wrench away! Will work with GM, Ford & Chrysler 3 or 4 speed automatic transmissions. Please refer to the Tilt/Tele Conversion Chart (below) to determine the proper column size.

SPECIFICATIONS

- TUBE DIAMETER: 2 1/4"
- 21 1/4" SHORTY: 3/4" DD LOWER SHAFT
REGULAR LENGTH STEEL: 1" DD LOWER SHAFT
REGULAR LENGTH ALUMINUM: 1"-48 LOWER SHAFT
- STEERING WHEEL ADAPTOR BOLT PATTERNS:
5-BOLT, 6-BOLT, OR 9-BOLT
- 3 7/8" GM STYLE WIRING PLUG
- CUSTOM LENGTHS AND OPTIONAL NEUTRAL SAFETY SWITCH ARE AVAILABLE
- ALL MEASUREMENTS ARE IN A COLLAPSED POSITION, THE COLUMN WILL TELESCOPE 1 1/2" TOWARDS THE DRIVER
- PLEASE NOTE: THIS COLUMN DOES **NOT** COME WITH A NEUTRAL SAFETY SWITCH. IF YOU HAVE A TRANSMISSION MOUNTED SWITCH, A NEUTRAL SAFETY SWITCH ON THE COLUMN IS NOT NEEDED.



12 POSITION LOWER SHIFT ARM



9-BOLT PART NUMBERS

	Paintable Steel	Chrome	Black Powder Coated	Brushed Aluminum	Polished Aluminum
21 1/4"	1190180010	1190180020	1190180051	1060180030	1060180040
31 1/4"	1190280010	1190280020	1190280051	1060280030	1060280040
33 1/4"	1190300010	1190300020	1190300051	1060300030	1060300040
36 1/4"	1190330010	1190330020	1190330051	1060330030	1060330040
38 1/4"	1190350010	1190350020	1190350051	1060350030	1060350040

The above part numbers are for the Tilt/Tele column with a 9-bolt adaptor. Call us or refer to the price list for part numbers for columns with 5 or 6-bolt adaptors.

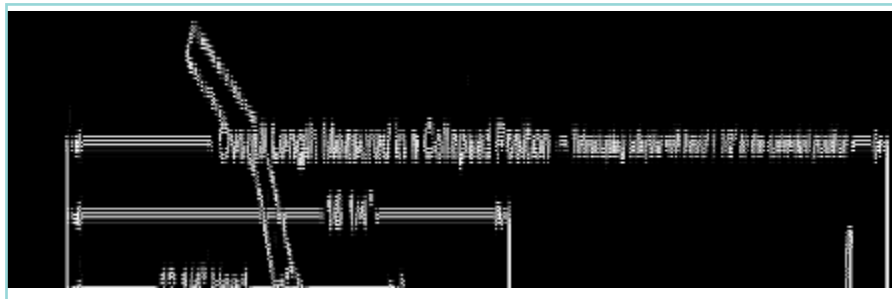

TILT / TELE CONVERSION CHART (Adaptor included in measurement)

18" Tilt Column = 21 1/4" Tilt/Tele Column
28" Tilt Column = 31 1/4" Tilt/Tele Column
30" Tilt Column = 33 1/4" Tilt/Tele Column
33" Tilt Column = 36 1/4" Tilt/Tele Column
35" Tilt Column = 38 1/4" Tilt/Tele Column

TECH TIP

IF YOU WOULD LIKE TO ADD A NEUTRAL SAFETY SWITCH TO YOUR COLUMN, THE LOCATION OF THE SWITCH MUST BE DETERMINED BEFORE PURCHASING THE COLUMN. ADDITIONAL CHARGES WILL APPLY.



Shorty

UNIVERSAL series

Need some extra space? Got an angle issue? If so, then the ididit Shorty column is your answer! ididit Shorty columns are designed to move around your big block and/or headers and can fit your custom application. The Shorty column is your go-to problem solver and allows you to choose the best angle to ensure driver comfort. ididit Shorty columns are available in our Classic, Straight, Tilt and Tilt & Telescoping styles in either floor shift or column shift. You can even upgrade to a keyed or Touch-N-Go Start ignition. The possibilities are endless!



SHORTY COLUMN INSTALLATION

STEP 1



Affix your adjustable under dash mount to the firewall and the dash

(Part # 2301000010)

(A support may need to be built behind the dash)



STEP 2



Attach the column to the mount using two steering column drops. Holes have been provided on the underdash mount to allow you to adjust the position of the column drops to where you see fit. The bigger the difference in length between the two drops, the greater the angle of the column will be.

STEP 3

Install a Flange Bearing to support your steering shaft, and to seal the fire wall. (Part# MSD52130) Attach the universal joint(s) and shafting from the column to the steering box or rack. Most universal joints can bend up to 35 degrees. If you need more than 35 degrees, but less than 70, a double u-joint is required. A support or rod end bearing is necessary for every u-joint over two within the system.



SUPPORT BEARING

Aluminum - Part # 3000650000

Polished Aluminum - Part # 3000660000



ROD END BEARING

Steel - Part # 3000700000

Stainless - Part # 3000710000

Polished Stainless - Part # 3000720000



COLUMN SHIFT

When using a column shift, you will need to mount the cable shift linkage to the base of the column. Route the cable through the kick panel to the transmission.



FINISHING STEPS

FLANGE BEARING

Part # MSD52130



Enjoy the increased foot and pedal space, as well as the added clearance around your engine and full use of your tilt column!

Steer Clear

BY WIZARD FABRICATION



WIZARD FABRICATION'S STEER CLEAR

Wizard Fabrication's Steer Clear is a revolutionary unit that offers you a complete solution to clearance problems encountered under the hood. It provides almost unlimited options for steering shaft clearance so a high performance engine and headers will fit, and it allows you to safely reposition the steering column to increase legroom and improve comfort. Internally this unit has precision sprockets, bearings and chain to allow for a smooth, safe and consistent feel. Steer Clear is made using a common 3/4" 36 spline input & output shafts which are popular in most steering systems and works with commonly available u-joints, couplers and vibration reducers. See it installed at www.wizardsteerclear.com



STEER CLEAR ADVANTAGES

- STEER CLEAR IS VERSATILE. IT CAN BE USED IN CUSTOM BUILDS, STREET RODS, NEWER VEHICLES, OFF-ROAD VEHICLES, JEEPS, WATER CRAFT AND MORE.
- STEER CLEAR IS SLEEK AND COMPACT. IT TAKES UP A MINIMAL AMOUNT OF SPACE AND CAN BE MOUNTED ON EITHER SIDE OF THE FIREWALL AT ANY ANGLE NECESSARY. THE FOUR REINFORCED THROUGH-HOLES ASSURE YOU A STRONG, SECURE INSTALLATION.
- ALLOWS YOU TO SAFELY RELOCATE THE STEERING COLUMN TO A MORE HORIZONTAL POSITION, ALLOWING FOR BETTER STEERING WHEEL POSITION FOR A MORE NATURAL AND COMFORTABLE FEEL WHILE IMPROVING DRIVER COMFORT.
- CAN GIVE YOU ADDITIONAL PEDAL CLEARANCE, NO MORE COLUMN STUCK BETWEEN YOUR PEDALS.
- ALLOWS YOU TO RAISE OR DROP THE STEERING SHAFT. MOVE IT OVER, OR CHANGE ITS ANGLE FOR INCREASED CLEARANCE AND AN EASIER FIT FOR YOUR ENGINE OR EXHAUST.



Available in five standard lengths:
8", 10", 12", 14" or 16"

Available in **Brushed** or **Polished** finishes

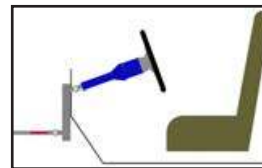

Adding the Steer Clear unit allows the column to stop at the firewall and allows the output shaft to be offset, positioning it lower in order to clear the engine.

BEFORE

Like most street rods, usable floor space is reduced by the position of the steering column. As a result, the driver is left with very little foot room and a steering wheel feel that has an awkward feel to it.



AFTER

After installing Steer Clear in his Foose-built 34 Ford, 6' 7" Ray has enough room to stretch his legs out and drive in comfort.



THEORY OF A COLLAPSIBLE COLUMN

AND WHAT YOU SHOULD KNOW

idit collapsible columns are designed to collapse upon impact from either end. To help you further understand this valuable safety feature, we have included a general guide to the physics of a steering column impact and it's effects on different steering column applications.

In general, there are two different types of steering column impacts that can occur during an accident.

IMPACT 1 - *The gearbox and shaft hit the bottom of the column.*

This is caused by the frame collapsing and pushing toward the firewall. This type of impact will cause the column to shear the shaft pins internally and shorten the shaft and outer housings of the lower half of the column. Following U.S. Federal Motor Vehicle Safety Standards, the idit collapsible column will collapse into itself 5 inches (127mm). In order for this to occur, the floor mount must allow the column to slip towards the driver as it absorbs the impact. This slipping action can only take place at the lower mount. When choosing or designing your lower mount, please consider the fact that it must shear or slip with less than 550 lbs of pressure. idit offers a mount that meets these requirements, and can be adapted to most vehicles (see page 19).

IMPACT 2 - *The impact of the driver hitting the wheel.*

As previously described, our collapsible column will collapse from either end. As a column collapses from the engine side, the upper mount must absorb that energy in order to stop the column from hitting the driver. This will require the upper mount to be rigid one way (must absorb at least 750 lbs of pressure from engine impact), but slip the other way (must absorb 550 lbs of pressure from driver impact) in order for the column to collapse forward (*away from the driver*). See page 19 for idit collapsible underdash mount.

The following demonstrates the relationship between seat belt usage and column positioning:

LAP BELT - Your lap belt creates a pivot point which will cause you to impact the steering wheel at a forward and downward arc. This means you will impact the wheel/collapsible column within the designed approach angle. This scenario is most common with Street Rod columns as they tend to have more of a vertical angle when installed in the firewall (*see Figure 1*).

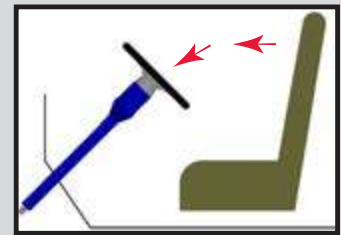

FIGURE 1

NO SEAT BELT - Unfortunately we see this happen, and it's never pretty. Figure 2 shows the result of the unprotected driver lifting off the seat and impacting the steering wheel with full force. Due to the vertical angle of the column, the steering wheel is unable to stop the driver from hitting the windshield. While you should always wear a seat belt, Figures 3 and 4 demonstrates how changing the angle of the column to a more horizontal position, will allow it to collapse properly upon impact and will give the body less tendency to go over the wheel and into the windshield. Lesson being, wear your seat belt.

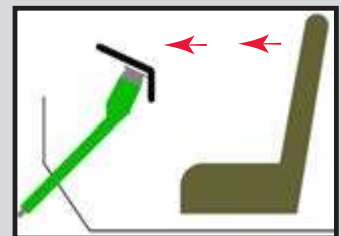

FIGURE 2

SEAT BELT WITH SHOULDER HARNESS - This is the ideal system. Combining the safety of the seat belt & shoulder harness with the horizontal angle of the column (shown in Figures 3 & 4) will help keep you in your seat, and allow our collapsible column do it's job properly - *lessen the impact of the crash*.

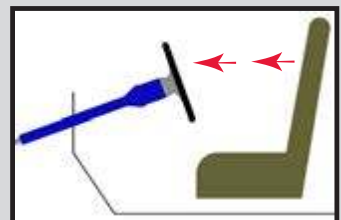

FIGURE 3

Figure 4 represents an alternative safety system using Steer Clear. In this system, the column is angled in a more horizontal position which alleviates the column from hitting the engine upon impact. Adding the Steer Clear unit allows the column to stop at the firewall and allows the output shaft to be offset, positioning it lower in order to clear the engine. This in conjunction with a collapsible intermediate shaft is a great way to keep you safe and secure. With this system, the rack or gearbox can take a hit and the collapsible intermediate shaft will absorb the force.

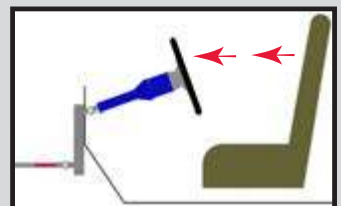

FIGURE 4

We have provided you with this information to help give you a better understanding of the different system theories. Each application will vary and proper installation is vital for the collapsible column to function as designed. For more information on these systems and regulations go to www.fmcsa.gov and search for code # 571.203 and 571.204. Additional information was gathered from The Society of Automotive Engineers Recommended Practice # J944

Collapsible

STEERING COLUMNS & accessories



COLLAPSIBLE FLOOR SHIFT

The ididit Collapsible column is one of the safest products you can install in your vehicle. Combined with the proper collapsible floor mount and underdash mount, this column will sustain impacts better than any standard steering column can, keeping you safe. ididit has gone through all the painstaking research ensuring that we are offering the latest technology in collapsibility and durability. But don't think you have to sacrifice style for safety. Our collapsible columns have the same clean look as our non-collapsible columns do. No unsightly laser cut mesh, no mess. This column features our unique 8-position tilt, which cannot be found anywhere else on the market. Self-canceling turn signals, 4-way flashers and our standard dress-up kit are also included with this column.

SPECIFICATIONS

- TUBE DIAMETER: UPPER 2 1/4" • LOWER 2"
- 1" DD LOWER SHAFT
- ACCEPTS 1969 OR NEWER GM PASSENGER CAR STEERING WHEELS
- 3 7/8" GM STYLE WIRING PLUG
- CUSTOM LENGTHS ARE NOT AVAILABLE

	Paintable Steel	Chrome	Black Powder Coated
28"	1300280010	1300280020	1300280051
30"	1300300010	1300300020	1300300051
32"	1300320010	1300320020	1300320051
35"	1300350010	1300350020	1300350051

TECH TIP

IF YOU ARE WELDING YOUR COLLAPSIBLE FLOOR MOUNT TO SECURE IT TO THE FLOOR, REMOVE THE O-RING BEFORE YOU START.

COLLAPSIBLE ACCESSORIES

Safely secure your column with these collapsible floor & dash mounts that are designed to work in conjunction with the collapsible steering column.

COLLAPSIBLE UNDERDASH MOUNT

2" Part # 2301410010
2 1/4" Part # 2301310010

This dash mount is specifically designed for the ididit Collapsible Series steering columns. The mounts located on either side of the mounting brackets have aluminum release blocks and when impacted, will slip or release allowing the mount to collapse forward (away from the driver) along with the rest of the collapsible steering system.

COLLAPSIBLE FLOOR MOUNT

2" Part # 2401010010
2 1/4" Part # 2402010010

This floor mount is designed to mount a steering column to the floor or firewall, and can be installed on either side of the firewall.



COLLAPSIBLE FLOOR MOUNT WITH PLATE

2" Part # 2401020010
2 1/4" Part # 2402020010

This floor mount is designed to mount a steering column to the floor or firewall, and can be installed on either side of the firewall. It includes extra material to allow you to cover any holes in the firewall left behind by the existing steering column. Trim to fit.



Right Hand Drive & Collapsible

STEERING COLUMNS

RIGHT HAND DRIVE COLLAPSIBLE TILT

For the dedicated hobbyist overseas, ididit offers a fully collapsible right hand drive steering column. The ididit Collapsible Series columns are one of the safest products you can install in your vehicle. Combined with the proper collapsible floor mount and underdash mount, this column will sustain impacts better than any standard steering column can, keeping you safe. Our Right Hand Drive Collapsible column includes all the same great features as our Universal Tilt Series columns such as, our unique 8-position tilt, self-canceling turn signals, 4-way flashers and our standard dress-up kit.

SPECIFICATIONS

- **TUBE DIAMETER:**
UPPER: 2 1/4" • LOWER: 2"
CAMARO UPPER: 2" • CAMARO LOWER: 2 1/4"
- **REGULAR LENGTH STEEL:** 1" DD LOWER SHAFT
1967-68 CAMARO: 1"-48 LOWER SHAFT
1968-69 MUSTANG: 3/4"-36 LOWER SHAFT
- **GM SHAFT:** ACCEPTS 1969 OR NEWER GM PASSENGER CAR STEERING WHEELS
- **FORD SHAFT:** EXCEPTS SAME YEAR STOCK WHEEL OR ADAPTOR FOR THE SAME YEAR COLUMN

	Paintable Steel	Chrome	Black Powder Coated
28"	1250280010	1250280020	1250280051
30"	1250300010	1250300020	1250300051
32"	1250320010	1250320020	1250320051
35"	1250350010	1250350020	1250350051
1967-68 Camaro	1250680010	1250680020	1250680051
1968 Mustang Ford Shaft	1250644010	1250644020	1250644051
1969 Mustang Ford Shaft	1250646010	1250646020	1250646051

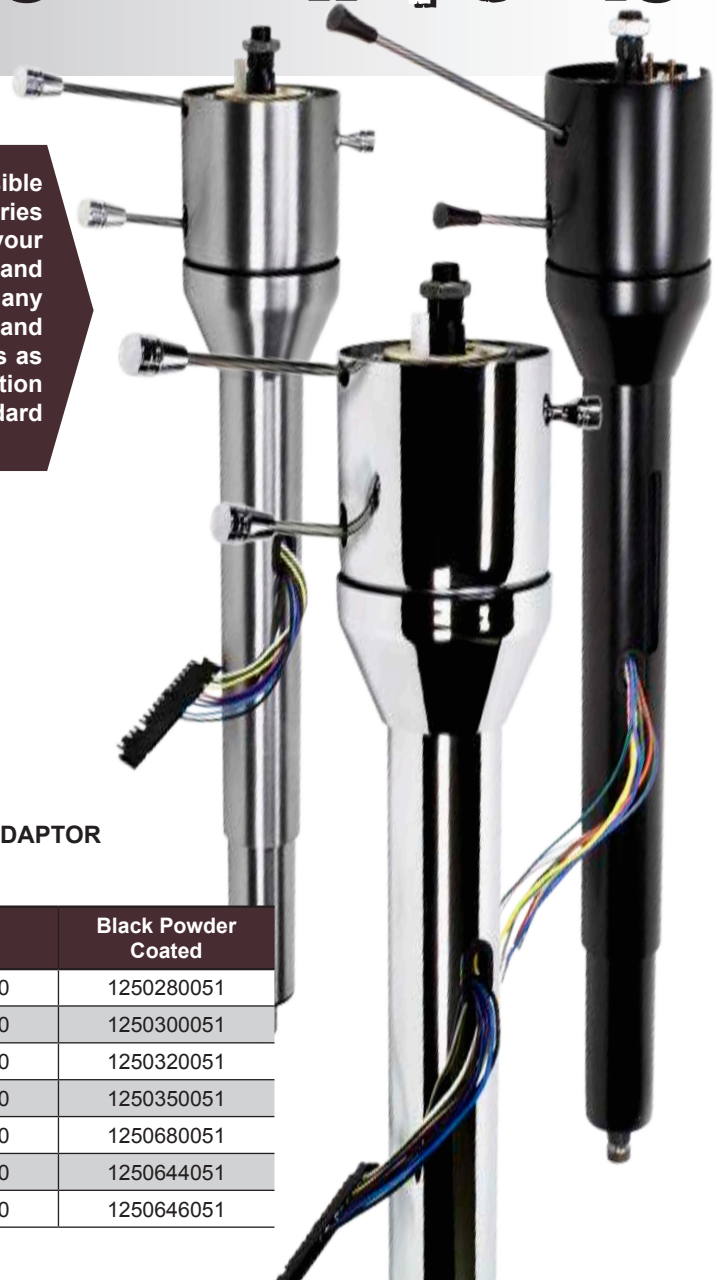

1955-56 CHEVY - COMES WITH

- 8-POSITION TILT
- SELF-CANCELING TURN SIGNALS
- 4-WAY FLASHERS
- RETRO STYLE KNOBS & LEVERS
- 3 7/8" WIRING PLUG
- TUBE DIAMETER: 2"
- 1" DD LOWER SHAFT
- ACCEPTS 1969 OR NEWER GM PASSENGER CAR STEERING WHEELS

1965-67 MUSTANG - COMES WITH

- 8-POSITION TILT
- FORD TURN SIGNAL SWITCH
- FORD SPLINED TOP SHAFT
- FORD STYLE KNOBS & LEVERS
- FLOOR MOUNT
- 4-WAY FLASHERS (67 ONLY)
- TUBE DIAMETER: 2 1/4"
- 3/4"-36 LOWER SHAFT
- EXCEPTS SAME YEAR STOCK WHEEL OR ADAPTOR FOR THE SAME YEAR COLUMN

RHD NON-COLLAPSIBLE TILT

ididit also offers a non-collapsible right hand drive column for our overseas friends who want the best for their Tri-Five or 1965-67 Mustang. These columns have all the same great features as their Retrofit Series counterparts but are designed to fit your right hand drive vehicle. If you don't find the column you need listed here please give us a call to see what we can do for you!

	Paintable Steel	Chrome	Black Powder Coated
1955-56 Chevy	1260550010	1260550020	1260550051
1965-66 Mustang	1260642010	1260642020	1260642051
1967 Mustang	1260643010	1260643020	1260643051

TECH TIP

IF USING A STOCK FORD STEERING WHEEL IT MUST BE FOR THE SAME YEAR APPLICATION AS THE COLUMN. USE OF A DIFFERENT YEAR WILL RESULT IN DAMAGE TO THE TURN SIGNAL SWITCH.

Retrofit Series

STEERING COLUMNS

THE BENEFITS OF CHOOSING AN IDIDIT RETROFIT STEERING COLUMN

- ▶ WE KNOW IT FITS! WE DESIGN THE COLUMN WITH THE VEHICLE IN HOUSE.
- ▶ MOST COLUMNS WILL FIT IN THE ORIGINAL POSITION WITH NO MODIFICATIONS TO YOUR VEHICLE.
- ▶ WE INCLUDE NEW FLOOR MOUNTS, WIRING ADAPTORS, DASH MOUNTS, ETC. WITH MANY OF OUR COLUMNS TO HELP MAKE THE TRANSITION FROM OLD TO NEW QUICK & EASY!
- ▶ 1969 & NEWER GM COLUMNS CAN USE THE STOCK STEERING WHEEL WITH NO ADAPTOR REQUIRED.

GM Columns



Tri-Five pg 24

Camaro/Firebird pg 26

Chevelle/El Camino IGTO pg 28



Corvette pg 30

Impala pg 32

Nova pg 34

Ford Columns



Falcon pg 36

Mercury Comet pg 37

Mustang pg 38

Mopar Columns



Cuda/Challenger pg 40

Chrysler B-Body pg 41



To us the term "Retrofit" means we have done the research, and have designed and developed a column that will fit your specific vehicle, often times with NO modification required to your vehicle. This means that when you buy one of our retrofit columns you are getting a perfectly engineered aftermarket column that will sit in the original steering column location, and in most cases, will put the steering wheel back in its original position. This is NOT a stock replacement, it's better! ididit Retrofit columns are designed with the vehicle in our shop to ensure the perfect fit and flawless installation. We've done the work so you won't have to!

In order to successfully accomplish this we must assume a few things:

- One, we assume you will be using an aftermarket wheel with your ididit retrofit column.
- Two, we assume the gearbox, firewall and dash have not been modified from their original state. This is the key to a perfect fit.

If you are unsure of what you have or have any questions regarding this please give us a call and we will be more than happy to help guide you through it.



QUICK REFERENCE GUIDE

ESSENTIAL PARTS WE'VE INCLUDED

USE THE CHART TO FIND WHAT ESSENTIAL PARTS ARE INCLUDED WITH YOUR IDIDIT COLUMN

GM Retrofit	Dash Mount	Floor Mount	Wiring Adaptor	Dash Locating Slot(s)	Other
1955-56 Chevy	OEM			X	
1957 Chevy	OEM				
1967 Camaro	OEM	OEM	X		
1968 Camaro	OEM	OEM	X		
1969 Camaro	OEM	OEM			
1970-75 Camaro	OEM	X	X		
1964-65 Chevelle	OEM	OEM			
1966 Chevelle	OEM	OEM			
1967-68 Chevelle	OEM	OEM	X		
1969-72 Chevelle	OEM	OEM			
1953-57 Corvette	OEM				
1958-62 Corvette	OEM	X			
1963-66 Corvette	OEM	OEM			
1968 Corvette	X	X	X		
1958 Impala	OEM	OEM			
1959-60 Impala/El Camino	OEM	OEM			
1961-62 Impala	OEM	OEM			
1963-64 Impala	OEM	OEM			Dash Bezel
1965-66 Impala	OEM	OEM		X	
1967 Impala	OEM	OEM	X		
1971-76 Impala/Caprice	OEM	OEM			
1962-66 Nova	OEM			X	
1967 Nova	OEM		X		
1969-73 Nova	OEM	OEM			
FORD Retrofit (Ford style)					
1964 Falcon	OEM	X	X	X	Gearbox Cover
1965 Falcon	OEM	X	X	X	Gearbox Cover
1965 Mercury	OEM	X	X		
1965-66 Mustang	OEM	X	X	X	Gearbox Cover
1967 Mustang	OEM	X	X	X	
1968 Mustang	OEM	X	X	X	
1969 Mustang	OEM	X	X	X	
FORD Retrofit (GM style)					
1964.5-66.5 Mustang	OEM		X		
1966.5-69 Mustang	OEM		X		

MOPAR Retrofit	Dash Mount	Floor Mount	Wiring Adaptor	Dash Locating Slot(s)	Other
1970-74 Cuda/Challenger	X	X	X		Ext. Shaft
1970-74 Cuda/Challenger w/ OE Wheel Adaptor	X	X	X		Ext. Shaft & OE Wheel Adaptor
1967-69 Chrysler B-Body	OEM	X	X		Ext. Shaft
1973 Chrysler B-Body	OEM	X	X		Ext. Shaft
GM Truck Retrofit					
47-54 Chevy Truck	X	X			
55-59 Chevy Truck	X	X			Gearbox Cover
60-66 Chevy Truck	OEM	OEM		X	
67-72 Chevy Truck	OEM	OEM	X		
67-72 Chevy Truck Column Shift	OEM	OEM	X	X	NSS
73-78 Chevy Truck			X		
FORD (Style) Truck Retrofit					
1974-74 Bronco	X	OEM	X		
1976-77 Bronco	X	OEM	X		
1965-66 Ford Truck	X	OEM	X		Ext. Shaft
1967-72 Ford Truck	X	OEM	X		Ext. Shaft
1973-77 Ford Truck	X	OEM	X		Ext. Shaft
1978-79 Ford Truck	X	OEM	X		
FORD (GM Style) Truck Retrofit					
1953-56 Ford Truck			X		Horn Relay
1965-66 Ford Truck	X	OEM	X		Horn Relay
1967-72 Ford Truck	X	OEM	X		Horn Relay
1973-77 Ford Truck	X	OEM	X		Horn Relay
1978-79 Ford Truck	X	OEM	X		Horn Relay
Jeep Retrofit					
1976-86 CJ5 & 7	OEM	OEM	X		

Please Note: Most column shift versions include a neutral safety switch



INDIVIDUAL KIT COMPONENTS

AND WHAT THEY ALL MEAN!

INTERMEDIATE SHAFT



THIS MILD STEEL SHAFT IS CUT TO LENGTH AND INSTALLED IN THE RAG JOINT AND/OR U-JOINT. SET SCREWS LOCK IT IN PLACE. THE 3/4" DD SHAPE OFFERS A SAFE & INEXPENSIVE WAY TO REPLACE YOUR OLD SHAFT. COLLAPSIBLE SHAFTS ARE AVAILABLE, ASK YOUR SALES REPRESENTATIVE FOR DETAILS

3/4"DD x 36
Part # 3000409436

MODIFIED SHAFT

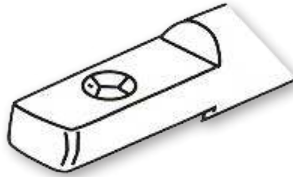

IF YOU ARE USING YOUR ORIGINAL MANUAL BOX AND PURCHASING AN ECONO KIT, FOR SOME APPLICATIONS, YOU WILL NEED TO CUT AND MODIFY YOUR 3/4" ROUND SHAFT INTO WHAT IS REFERRED TO AS A 3/4"DD SHAPE. INSTRUCTIONS TO DO THIS CAN BE FOUND IN THE SUPPLIED INSTALLATION INSTRUCTIONS BOOKLET. TO WATCH THE VIDEO GO TO OUR YOUTUBE CHANNEL.

COUPLER



THESE ARE USED TO MAKE AN IN-LINE CONNECTION FROM THE INTERMEDIATE SHAFT TO THE COLUMN.

3/4"-36 x 3/4"DD
Part # 3000313449
3/4"-36 x 3/4"-36
Part # 3000313434
1"DD x 3/4"DD
Part # 3000315249
1"-48 x 3/4"DD
Part # 3000314349

VIBRATION JOINT



A VIBRATION JOINT IS A VIBRATION REDUCER USED BETWEEN YOUR INTERMEDIATE SHAFT & GEARBOX AND IS USED WHEN AN ANGLE IS PRESENT IN YOUR STEERING SETUP.

3/4"DD x 3/4"-30
Part # 3000034931
3/4"DD x 13/16"-30
Part # 3000034940

RAG JOINT

A VIBRATION REDUCER USED BETWEEN YOUR INTERMEDIATE SHAFT & GEARBOX

3/4"-36 x 3/4"-30 Part # 3000053431	1"-48 x 3/4"-36 Part # 3000054334
3/4"-36 x 3/4"-36 Part # 3000053434	3/4"DD x 3/4"-30 Part # 3000054931
3/4"-36 x 13/16"-36 Part # 3000053440	3/4"DD x 13/16"-36 Part # 3000054940
3/4"DD x 3/4"-36 Part # 3000053449	1"DD x 3/4"-30 Part # 3000055231
1"DD x 3/4"-36 Part # 3000053452	1"DD x 13/16"-36 Part # 3000055240



UNIVERSAL JOINT



A U-JOINT CONNECTS THE INTERMEDIATE SHAFT TO THE IDIDIT COLUMN & IS USED WHENEVER THERE IS ANY TYPE OF BEND FROM YOUR COLUMN TO YOUR BOX OR RACK.

3/4"-36 x 3/4"DD
Part # 3000013449
1"DD x 3/4"DD
Part # 3000014952
1"-48 x 3/4"DD
Part # 3000014349

4-WAY FLASHER KIT

THIS WIRING KIT IS USED TO ADAPT YOUR STOCK WIRING TO YOUR IDIDIT COLUMN, WHILE ADDING THE SAFETY OF A 4-WAY FLASHER TO YOUR VEHICLE.

1955 Chevy & 1953-62 Corvette
Part # 3100035775

1956 Chevy
Part # 3100035780

1957-58 Chevy
Part # 3100035785

1964-66 Chevelle & 1966 Nova
Part # 3100037542

1959-62 Chevy, 1962 Nova & 1963 Corvette
Part # 3100037616

63-66 FI Sz Chevy & Truck, 63-65 Nova & 64-66 Vette
Part # 3100037618

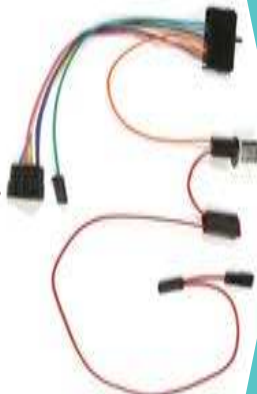

Chevy Tri-Five

1955-1957

TILT FLOOR SHIFT

Considering the unwavering popularity of the 1955-57 Chevy, we would not be doing our jobs if we didn't offer a retrofit column for these legendary machines. Whether you're using the original manual gearbox, an aftermarket power box or converting to an all new rack and pinion,* ididit has the column and the installation pieces you need to make this Classic even better.

* Some rack & pinion applications may require a longer column. Call us for more information.

COMES WITH

- 8-POSITION TILT
- SELF-CANCELING TURN SIGNALS
- 4-WAY FLASHERS
- RETRO KNOBS & LEVERS
- 3 7/8" WIRING PLUG
- 1"DD LOWER SHAFT



TECH TIP

WANNA USE YOUR ORIGINAL STEERING WHEEL WITH YOUR IDIDIT COLUMN? YOU CAN WITH THE HELP OF IDIDIT'S 1955-68 HORN KIT. (SEE PG 61 FOR MORE DETAILS.) MODIFICATION TO YOUR ORIGINAL WHEEL IS REQUIRED WITH THE USE OF THIS KIT.

	Paintable Steel	Chrome	Black Powder Coated	Brushed Aluminum	Polished Aluminum
1955 Chevy	1120550010	1120550020	1120550051	1070550030	1070550040
1956 Chevy	1120550010	1120550020	1120550051	1070550030	1070550040
1957 Chevy	1120570010	1120570020	1120570051	1070570030	1070570040

TECH TIP

NEED SOME EXTRA "BELLY ROOM"? IDIDIT OFFERS A 9-BOLT "SHORTY" STEERING WHEEL ADAPTOR THAT AFFIXES TO THE TOP OF YOUR IDIDIT TRI-FIVE COLUMN AND BRINGS YOUR WHEEL 2" CLOSER TO THE DASH. SEE PAGE 61 FOR MORE DETAILS.

Please note: a Cable Shift Linkage Kit is not recommended for use with Tri-Fives

TILT COLUMN SHIFT

Add the convenience of a column shift to your classic! Available with 8-position tilt or straight. This column comes with everything you'll need to use your original dash indicator (aftermarket shift indicator sold separately.) The shift pattern on the column allows you to use either a 3 or 4-speed automatic transmission (except early Powerglides, as they are a reverse pattern transmission.) A solid shift linkage (new or original) is required for installation and will attach to the lower shift arm provided on the column.

Warning: The 1957 Tilt Column Shift column will move the steering wheel 2" closer to your body compared to the original. To alleviate this issue use the available straight 1957 column shift or a "Shorty" 9 bolt adaptor with an aftermarket wheel.

COMES WITH

- 8-POSITION TILT OR STRAIGHT
- 4-WAY FLASHERS

- SELF-CANCELING TURN SIGNALS
- NEUTRAL SAFETY SWITCH

- RETRO KNOBS & LEVERS
- 3 7/8" WIRING PLUG
- 3/4"-36 LOWER SHAFT

Shift indicator not included



	Paintable Steel	Chrome	Black Powder Coated	Brushed Aluminum	Polished Aluminum
1955 Tilt	1140550010	1140550020	1140550051	1150550030	1150550040
1955 Straight	1160550010	1160550020	1160550051	N/A	N/A
1956 Tilt	1140550010	1140550020	1140550051	1150550030	1150550040
1956 Straight	1160550010	1160550020	1160550051	N/A	N/A
1957 Tilt	1140570010	1140570020	1140570051	1150570030	1150570040
1957 Straight	1160570010	1160570020	1160570051	N/A	N/A

Installation Kits

All the necessary components needed for flawless installation

ORIGINAL HARNESS

For vehicles with an original factory harness, a 4-way flasher kit is included with these kits. This 4-way flasher kit will not only add safety to your vehicle, but will also convert your original wiring harness to the 3 7/8" plug found on your ididit column. We have separate kits available for those using a POWER BOX, MANUAL BOX, or don't have a box specified. These kits include all the necessary parts you will need to install the column to the gearbox. Please note: If you will be using the original manual box, the 3/4" round shaft will need to be cut and modified into what is referred to as a 3/4"DD shape. *Borgeson box requires a 18mm DD rag joint



605 POWER GEARBOX

1955 (Floor Shift)
Part # 3005001005
Includes Rag Joint, Floor Mount, 4-way Flasher Kit

1955 (Column Shift)
Part # 3005004005
Includes Rag Joint, Floor Mount, 4-way Flasher Kit

1956 (Floor Shift)
Part # 3005001006
Includes Rag Joint, Floor Mount, 4-way Flasher Kit

1956 (Column Shift)
Part # 3005004006
Includes Rag Joint, Floor Mount, 4-way Flasher Kit

1957 (Floor Shift)
Part # 3005001007
Includes Rag Joint, Floor Mount, 4-way Flasher Kit

1957 (Column Shift)
Part # 3005004007
Includes Rag Joint, Floor Mount, 4-way Flasher Kit

MANUAL GEARBOX

1955 (Floor Shift)
Part # 3004002005
Includes Coupler, Floor Mount, 4-way Flasher Kit

1955 (Column Shift)
Part # 3004001005
Includes Coupler, Floor Mount, 4-way Flasher Kit

1956 (Floor Shift)
Part # 3004002006
Includes Coupler, Floor Mount, 4-way Flasher Kit

1956 (Column Shift)
Part # 3004001006
Includes Coupler, Floor Mount, 4-way Flasher Kit

1957 (Floor Shift)
Part # 3004002007
Includes Coupler, Floor Mount, 4-way Flasher Kit

1957 (Column Shift)
Part # 3004001007
Includes Coupler, Floor Mount, 4-way Flasher Kit

NO GEARBOX SPECIFIED

1955
Part # 3008001005
Includes Floor Mount, 4-way Flasher Kit

1956
Part # 3008001006
Includes Floor Mount, 4-way Flasher Kit

1957
Part # 3008001007
Includes Floor Mount, 4-way Flasher Kit

605 POWER GEARBOX

1955-57 (Floor Shift)
Part # 3005001000
Includes Rag Joint, Floor Mount

1955-57 (Column Shift)
Part # 3005004000
Includes Rag Joint, Floor Mount

NO GEARBOX SPECIFIED

MANUAL GEARBOX

1955-57 (Floor Shift)
Part # 3004002000
Includes Coupler, Floor Mount

1955-57 (Column Shift)
Part # 3004001000
Includes Coupler, Floor Mount

1955-57 Part # 2401400010
Includes Coupler, Floor Mount

AFTERMARKET HARNESS

Many aftermarket wiring companies offer replacement harnesses that incorporate a 4-way flasher unit as well as the flat 3 7/8" plug therefore a 4-way flasher kit is not included in these kits. We have separate kits available for those using a POWER BOX, MANUAL BOX, or don't have a box specified. These kits include all the necessary parts you will need to install the column to the gearbox. Please note: If you will be using the original manual box, the 3/4" round shaft will need to be cut and modified into what is referred to as a 3/4"DD shape.

HAVE A RACK & PINION?

Due to the variety of rack & pinion set ups out there call ididit for details on the u-joints & shafting you'll need.

NOT SURE WHAT YOU HAVE? Give us a call and we can help determine what you have and what application will work the best.



1955-56 CHEVY TRANSMISSION INDICATOR

Part # TRI1055
Made by Trim Parts. Injected molded using UV stabilized clear acrylic. No wavy lines or distortions. Available for 3 speed & overdrive transmissions.

CHEVY FLOOR MOUNT

Part # 2401400010
ididit's Classic Chevy Floor mount uses the two original holes in the floor of your 55-57 Chevy to mount the bracket. Comes complete with a clamp to secure the bracket to the column. **A new floor mount is required for ALL installations.** **The original will not fit the ididit steering column**



1955-57 FLOOR MOUNT

Use this Borgeson mount to fill the gap/hole in the floor when mounting the steering column.
Brushed Aluminum **Part # BOR909011**
Polished Aluminum **Part # BOR909012**



Z WIRE

55-56 Part # ROU9.45
1957 Part # ROU9.45A
This shifter wire is used to connect the ididit steering column to your stock in-dash shift indicator.



Camaro/Firebird

1967-1969

TILT FLOOR SHIFT

Designed to fit your Camaro or Firebird and does NOT require modification to your original vehicle to install. Installs in the same location as the old column using your original under dash mount, floor mount and a new rag joint installation kit. Using an adaptor, add an aftermarket wheel or call ididit for info on retro-fitting the original wheel to the column.



COMES WITH

- 8-POSITION TILT
- SELF-CANCELING TURN SIGNALS
- 4-WAY FLASHERS
- KNOBS & LEVERS
- 3 7/8" WIRING PLUG
- 67-68: 1"-48 LOWER SHAFT
- 69: 3/4"-36 LOWER SHAFT
- 67-68 INCLUDES WIRING HARNESS ADAPTOR
- 69 PLUGS DIRECTLY INTO FACTORY WIRING
- 69 INCLUDES IGNITION & RELAY PACK

	Paintable Steel	Chrome	Black Powder Coated	Brushed Aluminum	Polished Aluminum
1967-68	1120680010	1120680020	1120680051	1070680030	1070680040
1969 w/ Key*	1520790010	1520790020	1520790051	N/A	N/A
1969 w/Touch-N-Go*	1526790010	1526790020	1526790051	N/A	N/A

*Ignition excluded on '69 Firebird. Call ididit to find out why.
If using an aftermarket fuel injection system with an ididit ignition column please call.



TECH TIP

ORIGINAL '69 CAMARO FLOOR SHIFT COLUMNS CAME WITH A NEUTRAL SAFETY SWITCH (NSS). WHEN INSTALLING THE NEW IDIDIT '69 CAMARO FLOOR SHIFT COLUMN, YOU WILL NEED TO RELOCATE THE NSS TO THE TRANSMISSION.

TILT COLUMN SHIFT

This column shift has all the same great features as the floor shift, and is just as easy to install! The shift pattern on the column allows you to use either a 3 or 4-speed automatic transmission. A shift linkage (*new or original*) is required for installation and will attach to the lower shift arm provided on the column. Using an adaptor, add an aftermarket wheel and the gripping surface will be in the same location as the stock wheel.



TECH TIP

YOU CAN BOLT YOUR STOCK 1969 CAMARO STEERING WHEEL DIRECTLY TO THE IDIDIT STEERING COLUMN.

COMES WITH

- 8-POSITION TILT
- SELF-CANCELING TURN SIGNALS
- 4-WAY FLASHERS
- KNOBS & LEVERS
- NEUTRAL SAFETY SWITCH
Shift indicator not included
- 3 7/8" WIRING PLUG
- 3/4"-36 LOWER SHAFT
- 67-68 INCLUDES WIRING HARNESS ADAPTOR
- 69 PLUGS DIRECTLY INTO FACTORY WIRING
- 69 INCLUDES IGNITION & RELAY PACK

	Paintable Steel	Chrome	Black Powder Coated	Brushed Aluminum	Polished Aluminum
1967-68	1140680010	1140680020	1140680051	1150680030	1150680040
1969 w/ Key*	1540790010	1540790020	1540790051	N/A	N/A
1969 w/ Touch-N-Go*	1546790010	1546790020	1546790051	N/A	N/A

*Ignition excluded on '69 Firebird. Call ididit to find out why.

RAG JOINT Installation Kits

A rag joint is a vibration reducer used between your column & gearbox. In some vehicles, the original rag joint is pressed onto the lower shaft of the column. If yours has a pressed fit, it will need to be replaced. If yours is removable, the original may be used. However, please consider that due to age, the original rag joint may be worn so double check to make sure it is in good condition. *ididit, inc. always recommends replacing the rag joint.*

1967-68 (Floor Shift)

Part # 3000054331

Manual Gearbox: 3/4"-30
Includes 1"-48 x 3/4"-30
Rag Joint

1967-68 (Floor Shift)

Part # 3000054334

Manual Gearbox: 3/4"-36
Includes 1"-48 x 3/4"-36
Rag Joint

1967-68 (Floor Shift)

Part # 3000054340

Power Gearbox: 13/16"-36
Includes 1"-48 x 13/16"-36
Rag Joint

1967-68 (C/S) & 69 (all)

Part # 3000053431

Manual Gearbox: 3/4"-30
Includes 3/4"-36 x 3/4"-30
Rag Joint

1967-68 (C/S) & 69 (all)

Part # 3000053434

Manual Gearbox: 3/4"-36
Includes 3/4"-36 x 3/4"-36
Rag Joint

1967-68 (CS) & 69 (all)

Part # 3000053440

Power Gearbox: 13/16"-36
Includes 3/4"-36 x 13/16"-36
Rag Joint

Camaro

1970-1975

TILT FLOOR SHIFT

Designed to fit your Camaro and does NOT require modification to your original vehicle to install. The 1970-75 Camaro column is fully collapsible and comes standard with a keyed ignition in the original GM location. Installs in the same location as the old column using your original under dash mount and an ididit installation kit. Using an adaptor, add an aftermarket wheel and the gripping surface will be in the same location as the stock wheel. You can also bolt your original 1970-75 Camaro wheel directly to this column.

Please note: this column does not have the provision needed for the OEM Neutral Safety Switch or indicator. An alternate method must be used.

COMES WITH

- 8-POSITION TILT
- IGNITION & RELAY PACK
- SELF-CANCELING TURN SIGNALS
- 4-WAY FLASHERS
- KNOBS & LEVERS
- HORN WIRE
- 70-74: 3 7/8" WIRING PLUG
- 75: 4 1/4" WIRING PLUG
- 1"-48 LOWER SHAFT
- MODEL SPECIFIC FLOOR MOUNT
- PROVISIONS FOR MOUNTING BRACKETS

	Paintable Steel	Chrome	Black Powder Coated
1970-75 w/ Key	1620860010	1620860020	1620860051
1970-75 w/ Touch-N-Go	1626860010	1626860020	1626860051

If using an aftermarket fuel injection system with an ididit ignition column please call.

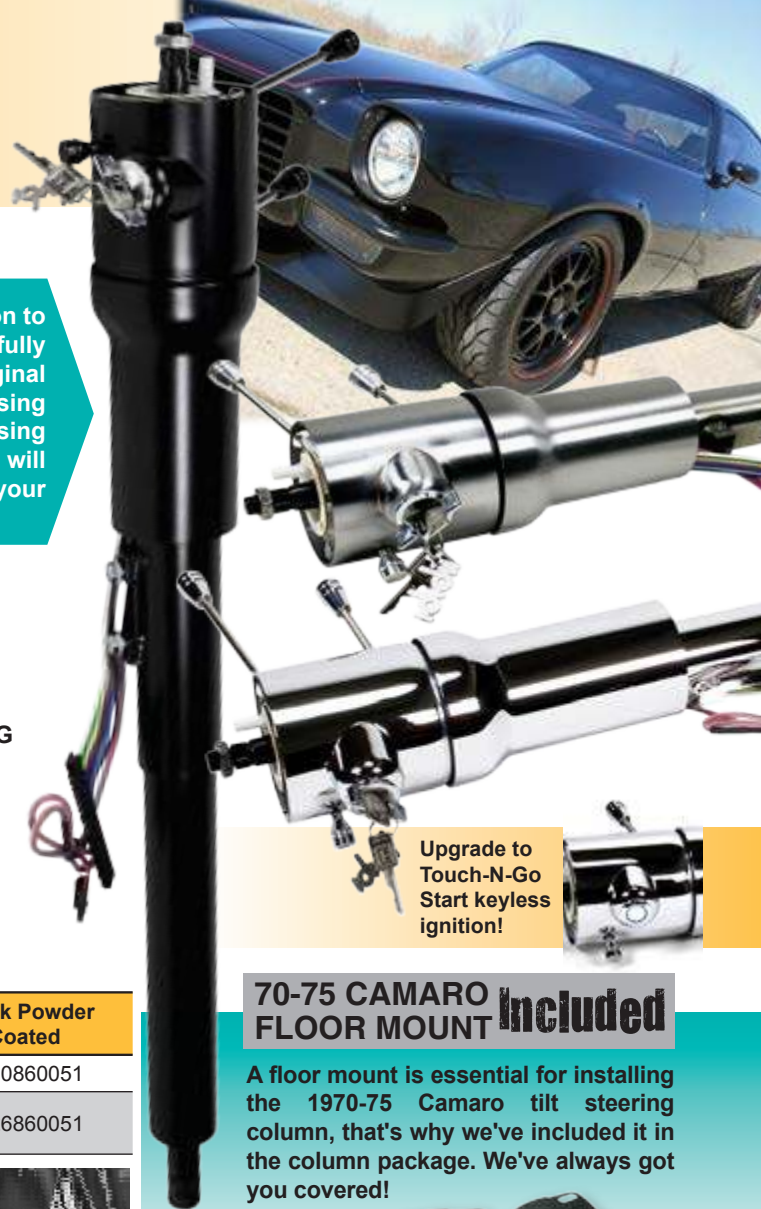
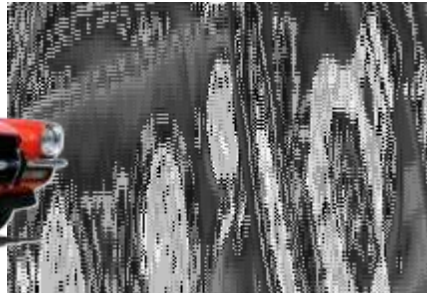

Upgrade to Touch-N-Go Start keyless ignition!

70-75 CAMARO FLOOR MOUNT **Included**

A floor mount is essential for installing the 1970-75 Camaro tilt steering column, that's why we've included it in the column package. We've always got you covered!



TECH TIP

YOU CAN BOLT YOUR STOCK 1970-75 CAMARO STEERING WHEEL DIRECTLY TO THE IDIDIT STEERING COLUMN.

Installation Kits

All the required components needed for flawless installation

If the original u-joint, shaft, or rag joint are missing, damaged, or worn one of the following installation kits will be required depending on the gearbox being used. *If you are using an aftermarket steering box, please call ididit for further information.*

1970-75

Part # 3011008000

Manual Gearbox: 3/4"-36

Includes 1"-48 x 3/4"DD U-Joint, 3/4"-36 x 1"DD Rag Joint and a Collapsible Intermediate Shaft

1970-75

Part # 3011009000

Power Gearbox: 13/16"-36

Includes 1"-48 x 3/4"DD U-Joint, 1"DD x 13/16"-36 Rag Joint and a Collapsible Intermediate Shaft



Chevelle/El Camino/GTO

1964-1972



TILT FLOOR SHIFT

Designed to fit your Chevelle, El Camino or GTO and does NOT require modification to your original vehicle to install. Installs in the same location as the old column using your original under dash mount, floor mount and an ididit installation kit. Using an adaptor, add an aftermarket wheel and the gripping surface will be in the same location as the stock wheel. Call ididit for info on retrofitting the original wheel to the column.

Please note: the 1969-72 column does not have the provision needed for the OEM Neutral Safety Switch or indicator. An alternate method must be used. See pg 56 for shift indicators.

COMES WITH

- 8-POSITION TILT
- SELF-CANCELING TURN SIGNALS
- 4-WAY FLASHERS
- KNOBS & LEVERS
- 64-68: 3 7/8" WIRING PLUG

- 69-72: 4 1/4" WIRING PLUG
- 64-65: 3/4"-36 LOWER SHAFT
- 66: 1" DD LOWER SHAFT
- 67-72: 1"-48 LOWER SHAFT
- 67-68 INCLUDES WIRING HARNESS ADAPTOR
- 69-72 INCLUDES IGNITION & RELAY PACK

	Paintable Steel	Chrome	Black Powder Coated	Brushed Aluminum	Polished Aluminum
1964-65	1120640010	1120640020	1120640051	1070640030	1070640040
1966	1120610010	1120610020	1120610051	1070610030	1070610040
1967-68	1120680010	1120680020	1120680051	1070680030	1070680040
1969-72 w/ Key*	1520690010	1520690020	1520690051	N/A	N/A
1969-72 w/ Touch-N-Go*	1526690010	1526690020	1526690051	N/A	N/A

*Ignition excluded on 1969 & 70 GTO. Call ididit to find out why. If using an aftermarket fuel injection system with an ididit ignition column please call.



TECH TIP

WITH THE HELP OF IDIDIT'S 1955-68 HORN KIT, YOU CAN BOLT MOST STOCK WHEELS TO YOUR IDIDIT COLUMN (SEE PG 61 FOR MORE DETAILS.)

TILT COLUMN SHIFT

This column shift has all the same great features as the floor shift, and is just as easy to install! The shift pattern on the column allows you to use either a 3 or 4-speed automatic transmission. A shift linkage (*new or original*) is required for installation and will attach to the lower shift arm provided on the column. Using an adaptor, add an aftermarket wheel and the gripping surface will be in the same location as the stock wheel.



	Paintable Steel	Chrome	Black Powder Coated	Brushed Aluminum	Polished Aluminum
1964-65*	1140640010	1140640020	1140640051	1150640030	1150640040
1966	1140610010	1140610020	1140610051	1150610030	1150610040
1967-68	1140680010	1140680020	1140680051	1150680030	1150680040
1969-72 w/Key**	1540690010	1540690020	1540690051	N/A	N/A
1969-72 w/ Touch-N-Go**	1546690010	1546690020	1546690051	N/A	N/A

* Column shift will not fit 1964-65 GTO's

**Ignition excluded on 1969 & 70 GTO. Call ididit to find out why. If using an aftermarket fuel injection system with an ididit ignition column please call.

COMES WITH

- 8-POSITION TILT
- SELF-CANCELING TURN SIGNALS
- 4-WAY FLASHERS
- NEUTRAL SAFETY SWITCH
Shift indicator not included
- KNOBS & LEVERS
- 64-68: 3 7/8" WIRING PLUG
- 69-72: 4 1/4" WIRING PLUG
- 64-68: 3/4"-36 LOWER SHAFT
- 69-72: 1"-48 LOWER SHAFT
- 69-72: IGNITION & RELAY PACK

Installation Kits

All the necessary components needed for flawless installation

DELUXE KITS - ORIGINAL HARNESS

For vehicles with an original factory harness, a 4-way flasher kit is included with these kits. This 4-way flasher kit will not only add safety to your vehicle, but will also convert your original wiring harness to the 3 7/8" plug found on your ididit column. These kits include all the necessary parts you will need to install the column to the gearbox. All you need to know is the diameter of the gearbox input shaft and the number of splines.

1964/65(F/S) & 1966(C/S) **Part # 3006001003**

Manual Gearbox: 3/4"-30
Includes Coupler,
Intermediate Shaft, Rag
Joint & 4-way Flasher Kit

1966 (Floor Shift)

Part # 3006004003

Manual Gearbox: 3/4"-30
Includes Coupler,
Intermediate Shaft, Rag
Joint & 4-way Flasher Kit

1964/65(F/S) & 1966(C/S) **Part # 3006002003**

Manual Gearbox: 3/4"-36
Includes Coupler,
Intermediate Shaft, Rag
Joint & 4-way Flasher Kit

1966 (Floor Shift)

Part # 3006005003

Manual Gearbox: 3/4"-36
Includes Coupler,
Intermediate Shaft, Rag
Joint & 4-way Flasher Kit

1965 (F/S) & 1966 (C/S) **Part # 3006003003**

Power Gearbox: 13/16"-36
Includes Coupler,
Intermediate Shaft, Rag
Joint & 4-way Flasher Kit

1966 (Floor Shift)

Part # 3006006003

Power Gearbox: 13/16"-36
Includes Coupler,
Intermediate Shaft, Rag
Joint & 4-way Flasher Kit

1964/65 (F/S) & 1966 (C/S)

Part # 3006001000

Manual Gearbox: 3/4"-30
Includes Coupler,
Intermediate Shaft, Rag Joint

1965 (F/S) & 1966 (C/S)

Part # 3006003000

Power Gearbox: 13/16"-36
Includes Coupler,
Intermediate Shaft, Rag Joint

1966 (Floor Shift)

Part # 3006005000

Manual Gearbox: 3/4"-36
Includes Coupler,
Intermediate Shaft, Rag Joint

1967-68 (Floor Shift)

Part # 3006009000

Power Gearbox: 13/16"-36
Includes Coupler,
Intermediate Shaft, Rag Joint

1969-72

Part # 3011007000

Manual Gearbox: 3/4"-30
Includes U-joint, Rag Joint,
Collapsible Intermediate Shaft

1964/65 (F/S) & 1966 (C/S)

Part # 3006002000

Manual Gearbox: 3/4"-36
Includes Coupler,
Intermediate Shaft, Rag Joint

1966 (Floor Shift)

Part # 3006004000

Manual Gearbox: 3/4"-30
Includes Coupler,
Intermediate Shaft, Rag Joint

1966 (Floor Shift)

Part # 3006006000

Power Gearbox: 13/16"-36
Includes Coupler,
Intermediate Shaft, Rag Joint

1967-68 (Column Shift)

Part # 3006001000

Manual Gearbox: 3/4"-30
Includes Coupler,
Intermediate Shaft, Rag Joint

1969-72

Part # 3011008000

Manual Gearbox: 3/4"-36
Includes U-joint, Rag Joint,
Collapsible Intermediate Shaft

DELUXE KITS - AFTERMARKET HARNESS

These kits include all the necessary parts you will need to install the column to the gearbox. Many aftermarket wiring companies offer replacement harnesses that incorporate a 4-way flasher unit as well as the flat 3 7/8" plug therefore, a 4-way flasher kit is not included in these kits. All you need to know before you order is the diameter of the gearbox input shaft and the number of splines.

1967-68 (Floor Shift)

Part # 3006007000

Manual Gearbox: 3/4"-30
Includes Coupler,
Intermediate Shaft, Rag Joint

1967-68 (Column Shift)

Part # 3006002000

Manual Gearbox: 3/4"-36
Includes Coupler,
Intermediate Shaft, Rag Joint

1969-72

Part # 3011009000

Manual Gearbox: 13/16"-36
Includes U-joint, Rag Joint,
Collapsible Intermediate Shaft

1967-68 (Floor Shift)

Part # 3006008000

Manual Gearbox: 3/4"-36
Includes Coupler,
Intermediate Shaft, Rag Joint

1967-68 (Column Shift)

Part # 3006003000

Power Gearbox: 13/16"-36
Includes Coupler,
Intermediate Shaft, Rag Joint

ECONO KITS

We had the builder on a budget in mind when we designed this kit. The original joint and intermediate shaft are used. The shaft will need to be cut and modified to match the 3/4" DD coupler. Due to age, the original rag joint may be worn so please double check to make sure it is in good condition.

We always recommend replacing the rag joint.



ORIGINAL HARNESS

1964/65 (F/S) & 1966 (C/S)

Part # 3001001003

Includes Coupler &
4-way Flasher Kit

1966 (Floor Shift)

Part # 3001002003

Includes Coupler &
4-way Flasher Kit

AFTERMARKET HARNESS

1964/65 (F/S) & 1966 (C/S)

Part # 3000313449

Includes 3/4" DD Coupler

1966 (Floor Shift)

Part # 3000315249

Includes
3/4" DD Coupler

Corvette

1953-1968



1953-62 STRAIGHT FLOOR SHIFT

Due to lack of space in front of the dash, the 1953-62 Corvette column is only available in straight floor shift. To install, simply remove your old column, saving your original under dash mount. You will be required to fabricate your own floor mount to safely secure the column to the firewall. The solid shaft that extends from inside the gearbox to the steering wheel will need to be cut and modified into the 3/4"DD shape in order to fit a coupler. Using an ididit installation kit, install your new steering column in place of the old. Add an aftermarket wheel with the help of the ididit 1956-62 Corvette Steering Wheel Adaptor.



COMES WITH

- SELF-CANCELING TURN SIGNALS
- 4-WAY FLASHERS
- RETRO STYLE KNOBS & LEVERS
- 3 7/8" WIRING PLUG
- 3/4"-36 LOWER SHAFT
- 58-62 INCLUDES MODEL SPECIFIC FLOOR MOUNT

	Paintable Steel	Chrome	Black Powder Coated	Brushed Aluminum	Polished Aluminum
1953-57 Straight	1010710010	1010710020	1010710051	N/A	N/A
1958-62 Straight	1010720010	1010720020	1010720051	1020720030	1020720040

CORVETTE STEERING WHEEL ADAPTORS



Do you want to use your original steering wheel with your new ididit column? Now you can with the help of an ididit Corvette Steering Wheel Adaptor. see page 61 for more details.



1963-66 TILT FLOOR SHIFT

This stylish 8-position tilt column is designed to fit your 1963-66 Corvette and does NOT require modification to your original vehicle to install. Easily installs in the same location as the old column using your original under dash mount, floor mount and a rag joint. You may use the original rag joint to connect to your gearbox as long as it's in good working condition, but due to age, it is highly recommended that you purchase a new one. Add an aftermarket wheel or use your original steering wheel with the help of an ididit 1963-66 Corvette Steering Wheel Adaptor.

Please note the space differences when using the original steering wheel vs an aftermarket wheel.
Tilt column with original wheel: 1/2" closer to the driver
Tilt column with aftermarket wheel: 1 1/2" closer to the dash

COMES WITH

- 8-POSITION TILT
- SELF-CANCELING TURN SIGNALS
- 4-WAY FLASHERS
- KNOBS & LEVERS
- 3 7/8" WIRING PLUG
- 3/4"-36 LOWER SHAFT

	Paintable Steel	Chrome	Black Powder Coated
1963-66 Tilt	1120770010	1120770020	1120770051





1968 TILT FLOOR SHIFT

This stylish 8-position tilt column is designed to fit your 1968 Corvette and does NOT require modification to your original vehicle to install. Easily installs in the same location as the old column using the new dash mount, floor mount and a rag joint. You may use the original rag joint to connect to your gearbox as long as it's in good working condition, but due to age, it is highly recommended that you purchase a new one. Add an aftermarket wheel or use your original steering wheel with the help of an ididit 1968 Corvette Steering Wheel Adaptor.



COMES WITH

- 8-POSITION TILT
- SELF-CANCELING TURN SIGNALS
- 4-WAY FLASHERS
- KNOBS & LEVERS
- 3 7/8" WIRING PLUG
- 1"-48 LOWER SHAFT
- PRE-WELDED UNDER DASH MOUNT
- MODEL SPECIFIC FLOOR MOUNT
- WIRING HARNESS ADAPTOR



	Paintable Steel	Chrome	Black Powder Coated
1968 Tilt	1120700010	1120700020	1120700051

All the necessary components needed for flawless installation

Installation Kits

ORIGINAL HARNESS

For vehicles with an original factory harness, a 4-way flasher kit is included with these kits. This 4-way flasher kit will not only add safety to your vehicle, but will also convert your original wiring harness to the 3 7/8" plug found on your ididit column. These kits include all the necessary parts you will need to install the column to the gearbox.

1953-62
Part # 3003003005
Includes
 3/4"-36 x 3/4"DD
 Coupler & 4-way
 Flasher Kit

1963
Part # 3003004001
Includes
 3/4"-36 x 3/4"-36
 Rag Joint & 4-way
 Flasher Kit

1964-66
Part # 3003004003
Includes
 3/4"-36 x 3/4"-36
 Rag Joint & 4-way
 Flasher Kit



1953-62
Part # 3000313449
Includes
 3/4"-36 x 3/4"DD
 Coupler

1963-66
Part # 3000053434
Includes
 3/4"-36 x 3/4"-36
 Rag Joint

1968 **Part # 3000054334**
Includes 1"-48 x 3/4"-36 Rag Joint

AFTERMARKET HARNESS

These kits include all the necessary parts you will need to install the column to the gearbox. Many aftermarket wiring companies offer replacement harnesses that incorporate a 4-way flasher unit as well as the flat 3 7/8" plug therefore, a 4-way flasher kit is not included in these kits.

Impala

1958-1976

TILT FLOOR SHIFT

Designed to fit your 58-67 & 71-76 Impala, 59-60 El Camino or 71-76 Caprice and does NOT require modification to your original vehicle to install. Installs in the same location as the old column using your original under dash mount, floor mount and an ididit installation kit. A new aluminum dash bezel is included with the 1963-64 column however, all the other columns will match the dash perfectly using the original bezel. Add an aftermarket wheel (using an adaptor) or original wheel but keep in mind that an aftermarket wheel may push the wheel closer to the driver and the original wheel will increase the overall length of the column towards the driver.

COMES WITH

- 8-POSITION TILT
- SELF-CANCELING TURN SIGNALS
- 4-WAY FLASHERS
- KNOBS & LEVERS
- 1958-60 INCLUDES RETRO STYLE KNOBS
- 3 7/8" WIRING PLUG
- 3/4"-36 LOWER SHAFT
- 1963-64 INCLUDES NEW DASH BEZEL
- 1967 INCLUDES WIRING HARNESS ADAPTOR
- 71-76 INCLUDES IGNITION & RELAY PACK

	Paintable Steel	Chrome	Black Powder Coated	Brushed Aluminum	Polished Aluminum
1958	1120580010	1120580020	1120580051	1070580030	1070580040
1959-60 Impala/El Camino	1120600010	1120600020	1120600051	1070600030	1070600040
1961-62	1120620010	1120620020	1120620051	1070620030	1070620040
1963-64	1120670010	1120670020	1120670051	1070670030	1070670040
1965-66	1120660010	1120660020	1120660051	1070660030	1070660040
1967	1120780010	1120780020	1120780051	1070780030	1070780040
1971-76 Imp/Caprice w/Key	1520760010	1520760020	1520760051	N/A	N/A
1971-76 Impala/Caprice w/Touch-N-Go	1526760010	1526760020	1526760051	N/A	N/A

If using an aftermarket fuel injection system with an ididit ignition column please call.

TECH TIP THE 1964 IDIDIT COLUMN IS NOT COMPATIBLE WITH THE 1964 IMPALA FACTORY TACHOMETER



TILT COLUMN SHIFT

The shift pattern on the column shift columns allows you to use either a 3 or 4-speed automatic transmission. A new aluminum dash bezel is included with the 1963-64 column however, all the other columns will match the dash perfectly using the original bezel. A shift linkage (*new or original*) is required for installation and will attach to the lower shift arm provided on the column. Add an aftermarket wheel (using an adaptor) or original wheel but keep in mind that an aftermarket wheel may push the wheel closer to the driver and the original wheel will increase the overall length of the column towards the driver.

COMES WITH

- 8-POSITION TILT
- SELF-CANCELING TURN SIGNALS
- 4-WAY FLASHERS
- NEUTRAL SAFETY SWITCH
- KNOBS & LEVERS
- 1958-60 INCLUDES RETRO STYLE KNOBS
- 3 7/8" WIRING PLUG
- 3/4"-36 LOWER SHAFT
- 1963-64 INCLUDES NEW DASH BEZEL
- 1967 INCLUDES WIRING HARNESS ADAPTOR
- 71-76 INCLUDES IGNITION & RELAY PACK

Shift indicator not included

	Paintable Steel	Chrome	Black Powder Coated	Brushed Aluminum	Polished Aluminum
1958	1140580010	1140580020	1140580051	1150580030	1150580040
1959-60 Imp/El Cam	1140600010	1140600020	1140600051	1150600030	1150600040
1961-62	1140620010	1140620020	1140620051	1150620030	1150620040
1963-64	1140670010	1140670020	1140670051	N/A	N/A
1965-66	1140660010	1140660020	1140660051	1150660030	1150660040
1967	1140780010	1140780020	1140780051	1150780030	1150780040
1971-76 Imp/Caprice w/Key	1540760010	1540760020	1540760051	N/A	N/A
1971-76 Impala/Caprice w/Touch-N-Go	1546760010	1546760020	1546760051	N/A	N/A



Installation Kits

All the necessary components needed for flawless installation

DELUXE KITS - ORIGINAL HARNESS

For vehicles with an original factory harness, a 4-way flasher kit is included with these kits. This 4-way flasher kit will not only add safety to your vehicle, but will also convert your original wiring harness to the 3 7/8" plug found on your ididit column. These kits include all the necessary parts you will need to install the column to the gearbox. All you need to know is the diameter of the gearbox input shaft and the number of splines. Please note 1965-66 is Rear Steer (the gearbox is near the back of the engine) so a u-joint & intermediate shaft is not needed, therefore they are not included in the install kit.

1958
Part # 3007001007
 Manual Gearbox: 3/4"-30
 Includes U-Joint, Intermediate Shaft, Rag Joint & 4-way Flasher Kit

1959-62
Part # 3007002001
 Manual Gearbox: 3/4"-36
 Includes U-Joint, Intermediate Shaft, Rag Joint & 4-way Flasher Kit

1965-66
Part # 3003001002
 Manual Gearbox: 3/4"-30
 Includes Rag Joint & 4-way Flasher Kit

1958
Part # 3007002007
 Manual Gearbox: 3/4"-36
 Includes U-Joint, Intermediate Shaft, Rag Joint & 4-way Flasher Kit

1963-64
Part # 3007001002
 Manual Gearbox: 3/4"-30
 Includes U-Joint, Intermediate Shaft, Rag Joint & 4-way Flasher Kit

1965-66
Part # 3003002002
 Manual Gearbox: 3/4"-36
 Includes Rag Joint & 4-way Flasher Kit

1959-62
Part # 3007001001
 Manual Gearbox: 3/4"-30
 Includes U-Joint, Intermediate Shaft, Rag Joint & 4-way Flasher Kit

1966-64
Part # 3007002002
 Manual Gearbox: 3/4"-36
 Includes U-Joint, Intermediate Shaft, Rag Joint & 4-way Flasher Kit

1965-66
Part # 3003003002
 Power Gearbox: 13-16"-36
 Includes Rag Joint & 4-way Flasher Kit

DELUXE KITS - AFTERMARKET HARNESS

These kits include all the necessary parts you will need to install the column to the gearbox. Many aftermarket wiring companies offer replacement harnesses that incorporate a 4-way flasher unit as well as the flat 3 7/8" plug therefore a 4-way flasher kit is not included in these kits. All you need to know before you order is the diameter of the gearbox input shaft and the number of splines. Please note 1965-67 is Rear Steer (the gearbox is near the back of the engine) so a u-joint & intermediate shaft is not needed, therefore they are not included in the install kit.

1958-64
Part # 3007001000
 Manual Gearbox: 3/4"-30
 Includes U-Joint, Intermediate Shaft, Rag Joint

1958-64
Part # 3007002000
 Manual Gearbox: 3/4"-36
 Includes U-Joint, Intermediate Shaft, Rag Joint

1965-67
Part # 3000053431
 Manual Gearbox: 3/4"-30
 Includes Rag Joint

1965-67
Part # 3000053434
 Manual Gearbox: 3/4"-36
 Includes Rag Joint

1965-67
Part # 3000053440
 Power Gearbox: 13/16"-36
 Includes Rag Joint



ECONO KITS

We had the builder on a budget in mind when we designed this kit. The original joint and intermediate shaft are used. The shaft will need to be cut and modified to match the 3/4" DD u-joint. Due to age, the original u-joint may be worn so please double check to make sure it is in good condition. We always recommend replacing the u-joint.

1963-64 DASH BEZEL Included



In the 1963-64 Impala the existing dash bezel is permanently attached to the original column. Therefore we've included a new dash bezel with your new 1963-64 ididit retrofit steering column.

ORIGINAL HARNESS

1958
Part # 3002001007
 Includes U-Joint & 4-way Flasher Kit

1959-62
Part # 3002001001
 Includes U-Joint & 4-way Flasher Kit

1963-64
Part # 3002001002
 Includes U-Joint & 4-way Flasher Kit

AFTERMARKET HARNESS

1958-64
Part # 3000013434
 Includes 3/4"-36 U-joint

TECH TIP

1958-60 IMPALA: THE COLUMN SHIFT COLUMN WILL MOVE THE STEERING WHEEL CLOSER TO YOUR BODY COMPARED TO THE ORIGINAL. ASK US HOW A SHORTY ADAPTOR OR NON-TILT COLUMN CAN HELP.

TECH TIP

1967 IMPALA: THE ORIGINAL DASH INDICATOR CAN NOT BE USED WITH THE '67 COLUMN SHIFT COLUMN. AN AFTERMARKET INDICATOR IS REQUIRED.



Nova

1962-1973

TILT FLOOR SHIFT

Designed to fit your Nova and does NOT require modification to your original vehicle to install. Installs in the same location as the old column. 1969-73 uses original under dash mount, floor mount and an ididit installation kit. 1962-67 Nova's can also reuse the original under dash mounts, but it is recommended that you purchase a NEW ididit 1962-67 Nova Floor Mount. Using an adaptor, add an aftermarket wheel and the gripping surface will be in the same location as the stock wheel. Call ididit for info on retro-fitting the original wheel to the column.

COMES WITH

- 8-POSITION TILT
- SELF-CANCELING TURN SIGNALS
- 4-WAY FLASHERS
- KNOBS & LEVERS
- 3 7/8" WIRING PLUG
- 3/4"-36 LOWER SHAFT
- 62-66 INCLUDES DASH LOCATING SLOT
- 69-73 INCLUDES IGNITION & RELAY PACK

	Paintable Steel	Chrome	Black Powder Coated	Brushed Aluminum	Polished Aluminum
1962-66	1120646010	1120646020	1120646051	1070646030	1070646040
1967	1120630010	1120630020	1120630051	1070630030	1070630040
1968	N/A	N/A	N/A	N/A	N/A
1969-73 w/ Key	1520720010	1520720020	1520720051	N/A	N/A
1969-73 w/ Touch-N-Go	1526720010	1526720020	1526720051	N/A	N/A

If using an aftermarket fuel injection system with an ididit ignition column please call.



TILT COLUMN SHIFT

This column shift has all the same great features as the floor shift, and is just as easy to install! The shift pattern on the column allows you to use either a 3 or 4-speed automatic transmission. A shift linkage (*new or original*) is required for installation and will attach to the lower shift arm provided on the column. Using an adaptor, add an aftermarket wheel and the gripping surface will be in the same location as the stock wheel.



COMES WITH

- 8-POSITION TILT
- SELF-CANCELING TURN SIGNALS
- 4-WAY FLASHERS
- NEUTRAL SAFETY SWITCH
Shift indicator not included
- KNOBS & LEVERS
- 3 7/8" WIRING PLUG
- 3/4"-36 LOWER SHAFT
- 62-66 INCLUDES DASH LOCATING SLOT
- 69-73 INCLUDES IGNITION & RELAY PACK

	Paintable Steel	Chrome	Black Powder Coated	Brushed Aluminum	Polished Aluminum
1962-66	1140646010	1140646020	1140646051	1150646030	1150646040
1967	1140630010	1140630020	1140630051	1150630030	1150630040
1968	N/A	N/A	N/A	N/A	N/A
1969-73 w/ Key	1540720010	1540720020	1540720051	N/A	N/A
1969-73 w/ Touch-N-Go	1546720010	1546720020	1546720051	N/A	N/A



TECH TIP

IDIDIT CABLE SHIFT LINKAGE KITS WILL NOT WORK FOR MOST NOVA'S WITH ORIGINAL OR IDIDIT STEERING COLUMNS.

Installation Kits

All the necessary components needed for flawless installation

ECONO KITS

We had the builder on a budget in mind when we designed this kit. The original joint and intermediate shaft are used. The shaft will need to be cut and modified to match the 3/4" DD coupler. Due to age, the original rag joint may be worn so please double check to make sure it is in good condition. *We always recommend replacing the rag joint.*

1967

Part # 3000313434

Includes 3/4"-36 x 3/4"-36 Coupler

ORIGINAL HARNESS

For vehicles with an original factory harness, a 4-way flasher kit is included in this kit. This 4-way flasher kit will not only add safety to your vehicle, but will also convert your original wiring harness to the 3 7/8" plug found on your ididit column.

1962

Part # 3001001001

Includes 3/4"-36 x 3/4"DD Coupler & 4-way Flasher Kit

1963-65

Part # 3001001002

Includes 3/4"-36 x 3/4"DD Coupler & 4-way Flasher Kit

1966

Part # 3001001003

Includes 3/4"-36 x 3/4"DD Coupler & 4-way Flasher Kit

AFTERMARKET HARNESS

Many aftermarket wiring companies offer replacement harnesses that incorporate a 4-way flasher unit as well as the flat 3 7/8" plug therefore a 4-way flasher kit is not included in these kits.

1962-66

Part # 3000313449

Includes 3/4"-36 x 3/4"DD Coupler

RAG JOINTS

A rag joint is a vibration reducer used between your column & gearbox. These kit's include a new 3/4"-36 rag joint. In order to choose the correct rag joint you will need to know the diameter of the gearbox input shaft and the number of splines. *ididit, inc. always recommends replacing the rag joint.*

1969-73

Part # 3000053431

Manual Gearbox: 3/4"-30

Includes 3/4"-36 x 3/4"-30 Rag Joint

1969-73

Part # 3000053434

Manual Gearbox: 3/4"-36

Includes 3/4"-36 x 3/4"-36 Rag Joint

1969-73

Part # 3000053440

Power Gearbox: 13/16"-36

Includes 3/4"-36 x 13/16"-36 Rag Joint

1962-67 NOVA FLOOR MOUNT

ididit recommends this special model specific floor mount for the 1962-67 Nova that will secure the lower end of your column to the firewall.

Part Number:
2400020010

Also works
great with a
Rack & Pinion!



TECH TIP

WITH THE HELP OF IDIDIT'S 1955-68 HORN KIT, YOU CAN BOLT MOST STOCK WHEELS TO YOUR IDIDIT COLUMN (SEE PG 61 FOR MORE DETAILS.)



Falcon

1964-1965



TILT FLOOR SHIFT

You asked for it, you got it! The Falcon tilt steering column is the newest Ford style column from ididit. Features all Ford wiring and will easily attach to your modified stock gearbox with a new coupler installation kit. Installs in the same location as the old column using your original under dash mount and the new model specific floor mount. Add your stock Falcon wheel and enjoy the convenience of 8-position tilt for that comfortable ride.

Please note: Dimmer/wiper and cruise control options can NOT be added to the Ford Style column due to the manufacturers design of the Ford Style wiring harness.

COMES WITH

- 8-POSITION TILT
- FORD SPLINED TOP SHAFT
- FORD TURN SIGNAL SWITCH
- FORD STYLE KNOBS & LEVERS
- SELF-CANCELING TURN SIGNALS
- GEARBOX COVER
- LOCATING SLOTS
- MODEL SPECIFIC FLOOR MOUNT
- 3/4"-36 LOWER SHAFT
- 65 COMES WITH FORD WIRING CONNECTORS
- 64 COMES WITH BULLET STYLE WIRING CONNECTORS
- 64 COMES WITH A HORN BRUSH

	Paintable Steel	Chrome	Black Powder Coated
1964	1170904010	1170904020	1170904051
1965	1170906010	1170906020	1170906051



TILT COLUMN SHIFT

This column shift has all the same great features as the floor shift, and is just as easy to install! The shift pattern on the column allows you to use either a 3 or 4-speed automatic transmission. This column utilizes the original transmission mounted neutral safety switch. A gear shift indicator is an option, but not included. A shift linkage (*new or original*) is required for installation and will attach to the lower shift arm provided on the column. Add your stock Falcon wheel directly to the column, no adaptor required.

Warning: The Column Shift column is 2" longer and will move the steering wheel 2" closer to the driver compared to the original.

	Paintable Steel	Chrome	Black Powder Coated
1964	1130904010	1130904020	1130904051
1965	1130906010	1130906020	1130906051

Included

The floor mount and gearbox cover are essential for flawless installation, so that's why they are included with every Falcon column! We've always got you covered!



65 Falcon Black

COUPLER Installation Kit

Required for installation

The 3/4" solid shaft from your original column will need to be cut & modified into what is referred to as a 3/4" DD shape.

Part # 3000313449

Includes 3/4"-36 x 3/4"DD Coupler

TECH TIP

WHEN INSTALLING YOUR OEM STEERING WHEEL TO YOUR IDIDIT FORD STYLE COLUMN, THE OEM WHEEL MUST BE FOR THE SAME YEAR APPLICATION AS THE COLUMN. USE OF A DIFFERENT YEAR WILL RESULT IN DAMAGE TO THE TURN SIGNAL SWITCH.



Mercury Comet

1965



TILT FLOOR SHIFT

A column for all the Mercury fans out there! This Ford style column will easily attach to your modified stock gearbox with a new coupler installation kit. Installs in the same location as the old column using your original under dash mount and the new model specific floor mount. Once in place, the original Comet wheel will be back in its original location and you'll have gained the convenience of 8-position tilt for that comfortable ride.

Please note: Dimmer/wiper and cruise control options can NOT be added to the Ford Style column due to the manufacturers design of the Ford Style wiring harness.

COMES WITH

- 8-POSITION TILT
- FORD SPLINED TOP SHAFT
- FORD TURN SIGNAL SWITCH
- FORD STYLE KNOBS & LEVERS
- SELF-CANCELING TURN SIGNALS
- MODEL SPECIFIC FLOOR MOUNT
- 3/4"-36 LOWER SHAFT
- FORD WIRING CONNECTORS

	Paintable Steel	Chrome	Black Powder Coated
1965	1170905010	1170905020	1170905051

1965 COMET FLOOR MOUNT **Included**

A floor mount is essential for installing the 1965 Mercury Comet tilt steering column, that's why we've included in the column package. We've always got you covered!



TECH TIP

WHEN INSTALLING YOUR OEM STEERING WHEEL TO YOUR IDIDIT FORD STYLE COLUMN, THE OEM WHEEL MUST BE FOR THE SAME YEAR APPLICATION AS THE COLUMN. USE OF A DIFFERENT YEAR WILL RESULT IN DAMAGE TO THE TURN SIGNAL SWITCH.

COUPLER Installation Kit

Required for installation

The 3/4" solid shaft from your original column will need to be cut & modified into what is referred to as a 3/4" DD shape.

Part # 3000313449

Includes 3/4"-36 x 3/4"DD Coupler



Mustang

1965-1969

FORD STYLE TILT FLOOR SHIFT

Mustang fan? Then these Ford Style columns are for you! They feature all Ford wiring and a Ford top shaft. We offer two types of columns for your specific year. Our standard column will bolt right to your stock box (using an ididit installation kit). Our rack version is made 1" shorter in order to lessen the angle of the U-joint when bolted into your rack & pinion system. Installs in the same location as the old column using your original under dash mount. A new column specific floor mount is included with every column and is designed to fit your application. Add your stock Mustang wheel and the gripping surface will be in the same location as the original.

Please note: Dimmer/wiper and cruise control options can NOT be added to the Ford Style column due to the manufacturers design of the Ford Style wiring harness.

COMES WITH

- 8-POSITION TILT
- FORD SPLINED TOP SHAFT
- FORD TURN SIGNAL SWITCH
- FORD STYLE KNOBS & LEVERS
- MODEL SPECIFIC FLOOR MOUNT
- FORD WIRING CONNECTORS
- 3/4"-36 LOWER SHAFT
- 68-69 IS FULLY COLLAPSIBLE
- 67-69 COMES WITH 4-WAY FLASHERS



	Paintable Steel	Chrome	Black Powder Coated
1965-66	1120642010	1120642020	1120642051
1965-66 w/Rack	1120644010	1120644020	1120644051
1967	1120643010	1120643020	1120643051
1967 w/Rack	1120645010	1120645020	1120645051
1968	1300644010	1300644020	1300644051
1968 w/Rack	1300645010	1300645020	1300645051
1969	1300646010	1300646020	1300646051
1969 w/Rack	1300647010	1300647020	1300647051

TECH TIP

WHEN INSTALLING YOUR OEM STEERING WHEEL TO YOUR IDIDIT FORD STYLE COLUMN, THE OEM WHEEL MUST BE FOR THE SAME YEAR APPLICATION AS THE COLUMN. USE OF A DIFFERENT YEAR WILL RESULT IN DAMAGE TO THE TURN SIGNAL SWITCH.

TECH TIP

THE 1965-66 IDIDIT MUSTANG COLUMN IS NOT COMPATIBLE WITH THE 1965-66 FACTORY RALLY PAC



MUSTANG FLOOR MOUNT Included

A new floor mount is essential for flawless installation, that's why we include a model specific floor mount with every ididit Mustang steering column.



Installation Kits

All the necessary components needed for flawless installation

1965-66 Manual Stock Box

Part # 3000313449

Includes 3/4"-36 x 3/4"DD Coupler. The 3/4" solid shaft from your original column will need to be cut & modified into what is referred to as a 3/4" DD shape.

TECH TIP

IF USING A BORGESON POWER ASSISTED BOX ON ANY YEAR MUSTANG, THE COLUMN WILL NEED TO BE SHORTER. CALL IDIDIT FOR ADDITIONAL INFO. (WILL NOT WORK FOR 1969 IDIDIT COLUMNS)

1965-66 & 1968-69

Rack & Pinion

3/4"DD x 3/4"-36 U-Joint

Part # 3000013449

18"DD Shaft Part # 3000409418

Manual Rack will also need a 3/4"DD x ? U-Joint (depending on manufacturers input shaft.) Power Rack will also need a 3/4"DD x ? Vibration Joint (depending on manufacturers input shaft.)

The 1967 Mustang used two types of stock boxes, "Long" and "Short." The Long box had one piece of shafting from the box to the upper shaft of the steering column. The Short box was attached to the column with a rag joint.

1967 Long Box

Part # 3000313449

Includes 3/4"-36 x 3/4"DD Coupler.

1967 Short Box

Part # 300600210

Includes 3/4"-36 x 3/4"DD Coupler, 2 5/16" long DD Shaft & 3/4"DD x 3/4"-36 Rag Joint

1968 Manual Stock Box

Part # 300600210

Includes 3/4"-36 x 3/4"DD Coupler, 2 5/16" long DD Shaft & 3/4"DD x 3/4"-36 Rag Joint

1969 Manual Stock Box

Part # 3000053434

Includes 3/4"-36 x 3/4"-36 Rag Joint



Mustang

1964.5-1969



GM STYLE TILT FLOOR SHIFT

This Mustang column is GM based and features a GM upper shaft, along with a 3 7/8" Wiring Plug. Some modification to the original gearbox and wiring will be required. Installs in the same location as the old column using your original under dash mount, floor mount and an ididit installation kit. Comes complete with a female end plug for your wiring. Using as adaptor, add an aftermarket wheel and the gripping surface will be in the same location as the original.

Because the GM Style column uses the standard GM wiring harness, dimmer/wiper and cruise control options CAN be added to the column. See pg 57 and 58 for more details.

COMES WITH

- 8-POSITION TILT
- SELF-CANCELING TURN SIGNALS
- 4-WAY FLASHERS
- KNOBS & LEVERS
- 3 7/8" WIRING PLUG
- 3/4"-36 LOWER SHAFT



	Paintable Steel	Chrome	Black Powder Coated	Brushed Aluminum	Polished Aluminum
1964.5-66.5	1120647110	1120647120	1120647151	1070647130	1070647140
1966.5-69	1120690010	1120690020	1120690051	1070690030	1070690040

TECH TIP

A STOCK FORD STEERING WHEEL WILL NOT BOLT TO THE IDIDIT GM STYLE MUSTANG STEERING COLUMN



Installation Kits

All the necessary components needed for flawless installation

1964.5-66.5

Part # 3000313449

Includes 3/4"-36 x 3/4"DD Coupler

Your original column has a solid shaft from inside the stock gearbox to the steering wheel. You will need to cut and modify this original shaft into what is referred to as a 3/4" DD shape. Use the coupler to connect the modified shaft to the ididit column.

1966.5-69

Part # 3000053434

Includes 3/4"-36 x 3/4"-36 Rag Joint

The rag joint will act as a coupler and a vibration reducer between your intermediate shaft and gearbox.

Turn Signal Wiring

Ford horn systems use two wires and 12 volts of power to control the horn function. ididit uses a ground type relay system. A relay is provided with your kit in order to successfully complete the conversion from the Ford system to the ididit system.

Cuda/Challenger

1970-1974

TILT FLOOR SHIFT

Got a Mopar? We've got you covered! This retrofit column is designed to fit your 1970-74 Chrysler E-Body Cuda/Challenger and does NOT require modification to your original vehicle to install. This column will easily bolt to your manual stock box, power box, or rack & pinion system using a new universal joint installation kit. This column is unique in the fact that it has the ability to fully collapse in 3 different areas, making it the safest aftermarket column you can buy. Do you want to use your OE Tuff Grip steering wheel or reproduction wheel? ididit gives you the option to include our specially designed Cuda/Challenger Steering Wheel Adaptor with your column order (use "1970-74 w/ OE wheel adaptor" part numbers).

COMES WITH

- 8-POSITION TILT
- IGNITION & RELAY PACK
- SELF-CANCELING TURN SIGNALS
- 4-WAY FLASHERS
- KNOBS & LEVERS
- 3 7/8" WIRING PLUG
- 3/4" DD EXTENDABLE LOWER SHAFT
- PRE-WELDED UNDER DASH MOUNT
- MODEL SPECIFIC FLOOR MOUNT
- MOPAR WIRING HARNESS ADAPTOR
- FULLY COLLAPSIBLE



	Paintable Steel	Chrome	Black Powder Coated
1970-74 w/Key	1620810010	1620810020	1620810051
1970-74 w/Key & OE wheel adaptor	1620820010	1620820020	1620820051
1970-74 w/Touch-N-GO	1626810010	1626810020	1626810051
1970-74 w/Touch-N-GO & OE wheel adaptor	1626820010	1626820020	1626820051

If using an aftermarket fuel injection system with an ididit ignition column please call.



Keyed ignition included or upgrade to Touch-N-Go Start keyless ignition!

FLOOR MOUNT & WIRING ADAPTOR Included

Because the floor mount & wiring adaptor is essential for flawless installation, ididit includes them with your 1970-74 Cuda/Challenger Tilt column.



U-JOINT Installation Kits

Required for flawless installation

A u-joint is required in order to install your ididit 1970-74 Cuda/Challenger column. A u-joint connects the steering box to the ididit column and is used whenever there is any type of bend from your column to your box or rack.

1970-74 Manual Gearbox
Part # 3000013449
Includes
3/4" DD x 3/4"-36
U-joint

1970-74 Power Gearbox
Part # 3000014921
Includes
3/4" DD x 5/8"-36C
U-joint

1970-74 CUDA CHALLENGER OE WHEEL ADAPTOR

This 3-bolt wheel adaptor is specially designed to bolt your OE steering wheel or reproduction wheel to your ididit 1970-74 Cuda/Challenger column.

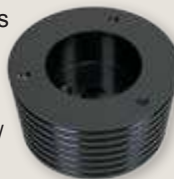

Available in:
Chrome 2209320020
Black Powder Coated 2209320051
Brushed Aluminum 2209320030
Polished Aluminum 2209320040

Adaptors & Horn Kit

HORN KIT FOR GRANT TUFF GRIP REPRODUCTION WHEEL



Part # 2611010010
This horn kit will allow you to use a

Grant Tuff Grip reproduction wheel with your ididit 1970-74 Cuda/Challenger column.

Chrysler B-Body

1967-1973



TILT FLOOR SHIFT

Designed to fit your Chrysler B-Body and does NOT require modification to your original vehicle to install. These columns are fully collapsible and will bolt right in to your manual box, power box or rack & pinion system. Installs in the same location as the old column using your original under dash mount and an ididit rag joint installation kit. Using an adaptor, add an aftermarket wheel and the gripping surface will be in the same location as the stock wheel.

Please note: A stock Chrysler steering wheel WILL NOT bolt to the ididit Chrysler B-Body steering column.

COMES WITH

- 8-POSITION TILT
- SELF-CANCELING TURN SIGNALS
- 4-WAY FLASHERS
- KNOBS & LEVERS
- YEAR SPECIFIC WIRE PLUG
- 3/4"DD EXTENDABLE LOWER SHAFT
- FULLY COLLAPSIBLE
- MODEL SPECIFIC FLOOR MOUNT
- WIRING HARNESS ADAPTOR
- PROVISIONS FOR MOUNTING BRACKETS
- 73 INCLUDES IGNITION & RELAY PACK

	Paintable Steel	Chrome	Black Powder Coated
1967-69	1300840010	1300840020	1300840051
1973 w/Key	1620870010	1620870020	1620870051
1973 w/Touch-N-GO	1626870010	1626870020	1626870051

If using an aftermarket fuel injection system with an ididit ignition column please call.

FLOOR MOUNT & WIRING ADAPTOR **Included**

The floor mount & wiring adaptor are essential for installing the 1967-69 & 1973 Chrysler B-body tilt steering columns, that's why we've included them in the column package. We've always got you covered!



RAG JOINT **Installation Kits**

Required for flawless installation

A rag joint is a vibration reducer used between your steering column and gearbox.

Please note: 2 different spline types were used with the power steering box. Check to verify which spline type you have to ensure proper rag joint fit.

1967-69 & 73
Part # 3000053449
 Manual Gearbox: 3/4"-36
 Includes 3/4"DD x 3/4"-36
 Rag Joint

1967-69 & 73
Part # 3000053449
 Power Gearbox: 3/4"-36
 Includes 3/4"DD x 3/4"-36
 Rag Joint

OR

1967-69 & 73
Part # 3000054921
 Power Gearbox: 5/8"-36C
 Includes 3/4"DD x 5/8"-36
 Rag Joint

TESTIMONIALS

FROM INDUSTRY EXPERTS

JESSE GREENING

Greening Auto Company

"For more than a decade we have been putting ididit columns in our builds. It doesn't matter if it's a Ridler build or a pro-touring/ daily driver it's getting an ididit. There is no beating the fit, finish, safety, and customer service of an ididit column."



JIM RING

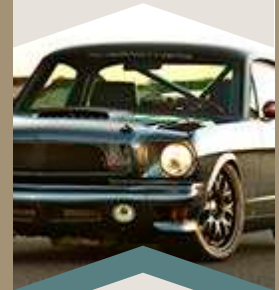

Ringbrothers

"There are many different steering columns available for our projects, ididit columns always get our projects turned in the right direction."

ROY BRIZIO

Roy Brizio Street Rods

I have been using ididit steering columns since their inception. Ken helped us car builders out so much when he introduced the ididit column. We no longer had to go to the wrecking yard to find a column to bring back to the shop and rebuild. Your product is the best, and that's what we want to put in our cars.



DAVE KINDIG



Kindig-It Design

"Whether it's polished, brushed or paintable, Kindig-it Design relies on ididit for high quality and a perfect fit every time."

ALAN JOHNSON

Johnson's Hot Rod Shop Inc.

"We never settle for less than the best for our customers and the projects we build. That is why I choose ididit and have done so for over 25 years. Their products and customer service have never let us down."



ZANE CULLEN



Cotati Speed Shop

"Cotati Speed Shop customers demand the finest components available. The team at ididit inc. deliver excellent customer service and quality products every time."

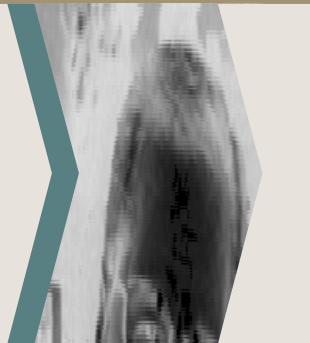

SAM MEMMOLO

TV Personality

"How can you beat a company that was born in America over 25 years ago and has grown to 32,000 square feet of good old American Quality Manufacturing.

ididit continues to demonstrate their incredible ingenuity with laser cuts, precision welders and meeting the growing needs of their customers with products that match. I have used several ididit columns over the past 15 years and have always been pleased with their service and technical expertise. Made in America means a lot to me!"

JOHN REID

Rods By Reid

"At Rods by Reid in Tauranga New Zealand, we have been using and recommending ididit products for nearly 20 years. Their top quality, American made product meets our high standards for safety, reliability, style, performance & function. ididit is the industry leader when it comes to custom steering columns.... producing steering columns you can trust."



CHRIS RYAN

Ryan's Rod and Kustom

"Here at Ryan's Rod and Kustom, we count on ididit as our one call solution to all of our steering column needs. You cannot surpass ididit's made in the USA top quality manufacturing. Their high level of customer service with a unparalleled selection of products to ensure proper fit for almost any application."



Retrofit Series

STEERING COLUMNS-TRUCKS

THE BENEFITS OF CHOOSING AN IDIDIT RETROFIT STEERING COLUMN

- ▶ WE KNOW IT FITS! WE DESIGN THE COLUMN WITH THE VEHICLE IN HOUSE.
- ▶ MOST COLUMNS WILL FIT IN THE ORIGINAL POSITION WITH NO MODIFICATIONS TO YOUR VEHICLE.
- ▶ WE INCLUDE NEW FLOOR MOUNTS, WIRING ADAPTORS, DASH MOUNTS, ETC. WITH MANY OF OUR COLUMNS TO HELP MAKE THE TRANSITION FROM OLD TO NEW QUICK & EASY!
- ▶ 1973 & NEWER GM COLUMNS CAN USE THE STOCK STEERING WHEEL WITH NO ADAPTOR REQUIRED.

GM Trucks



Chevy Truck pg 44

"NEW AGAIN"

Some of you may be familiar with Ken's 1965 F-100. This labor of love was completed in 2006, and was transformed panel by panel from a bone stock "county truck orange" truck, into the clean & stylish, one-of-a-kind truck you see today. Ken is very proud of his "project" and is thankful to all the talented craftsmen and companies that helped him along the way. He knew he could create something truly unique in this old truck, making it... "New Again"



Ford Trucks



Ford Bronco pg 47

Ford Truck pg 48



Jeep CJ



Jeep CJ5 & 7 pg 50

To us the term "Retrofit" means we have done the research, and have designed and developed a column that will fit your specific vehicle, often times with NO modification required to your vehicle. This means that when you buy one of our retrofit columns you are getting a perfectly engineered aftermarket column that will sit in the original steering column location, and in most cases, will put the steering wheel back in its original position. This is NOT a stock replacement, it's better! ididit Retrofit columns are designed with the vehicle in our shop to ensure the perfect fit and flawless installation. We've done the work so you won't have to!

In order to successfully accomplish this we must assume a few things:

- One, we assume you will be using an aftermarket wheel with your ididit retrofit column.
- Two, we assume the gearbox, firewall and dash have not been modified from their original state. This is the key to a perfect fit.

If you are unsure of what you have or have any questions regarding this please give us a call and we will be more than happy to help guide you through it.



Chevy Truck

1947-1978



TILT FLOOR SHIFT

We've got a wide selection of columns designed to fit your classic GM Truck! Each Chevy Truck column installs in the same location as the old and includes everything you'll need for flawless installation. All that's required is an ididit installation kit. **1947-54** Chevy Truck columns come complete with a new under dash mount and floor mount. The **1955-59** column comes with it's own specially designed under dash mount and floor mount with gasket, as well as an OE gearbox cover that is designed to protect the original gearbox from dirt and debris. Use your original under dash mount and floor mount to install the **1960-66** column. These columns also come with unique dash locating slots that allow for perfect installation every time. We offer both a standard and rack column for the **1967-72** Chevy Truck. The standard column will bolt right to your stock box (with a u-joint). The rack version is made shorter to lessen the angle of the u-joints. **1967-78** columns all install simply by using the original under dash mount and floor mount. Using an adaptor, add an aftermarket wheel and the gripping surface will be in the same location as the stock wheel. You can bolt your original **1973-78** steering wheel directly to the 1973-78 steering column, no adaptor required!

Please Note: A stock 1960-66 wheel can NOT be used with a 1960-66 ididit column See page 46 for Chevy Truck installation kits

COMES WITH

- 8-POSITION TILT
- SELF-CANCELING TURN SIGNALS
- 4-WAY FLASHERS
- KNOBS & LEVERS
- 1955-59 INCLUDES RETRO STYLE KNOBS
- 3 7/8" WIRING PLUG
- 73-78: 4 1/4" WIRING PLUG
- 47-59: 1" DD LOWER SHAFT
- 60-72: 3/4"-36 LOWER SHAFT
- 73-78: 1"-48 LOWER SHAFT
- 47-54 INCLUDES DASH MOUNT & FLOOR MOUNT
- 55-59 INCLUDES DASH MOUNT, MODEL SPECIFIC FLOOR MOUNT W/ GASKET & OE GEARBOX COVER
- 60-66 INCLUDES DASH LOCATING SLOT
- 67-72 INCLUDES WIRING HARNESS ADAPTOR
- 73-78 INCLUDES IGNITION & RELAY PACK



	Paintable Steel	Chrome	Black Powder Coated	Brushed Aluminum	Polished Aluminum
1947-54	1120651010	1120651020	1120651051	1070651030	1070651040
1955-59	1120652010	1120652020	1120652051	1070652030	1070652040
1960-66	1120650010	1120650020	1120650051	1070650030	1070650040
1967-72	1120657010	1120657020	1120657051	1070657030	1070657040
1967-72 w/ Rack	1120658010	1120658020	1120658051	1070658030	1070658040
1973-78 w/ Key	1520760010	1520760020	1520760051	N/A	N/A
1973-78 w/Touch-N-Go	1526760010	1526760020	1526760051	N/A	N/A



If using an aftermarket fuel injection system with an ididit ignition column please call.

TECH TIP

WANNA USE YOUR ORIGINAL 1967-72 WHEEL WITH YOUR 67-72 IDIDIT STEERING COLUMN? YOU CAN WITH THE HELP OF IDIDIT'S 1955-68 HORN KIT W/ RING. (SEE PG 61 FOR MORE DETAILS.)

TECH TIP 1960-66 CHEVY TRUCK COLUMN INCLUDES THE PROVISIONS NEEDED TO MOUNT THE EMERGENCY BRAKE HANDLE. (FOR STEEL, CHROME OR BLACK ONLY)



TILT COLUMN SHIFT

This column shift has all the same great features as the floor shift, and is just as easy to install! The shift pattern on the column allows you to use either a 3 or 4-speed automatic transmission. A shift linkage (*new or original*) is required for installation and will attach to the lower shift arm provided on the column. Using an adaptor, add an aftermarket wheel and the gripping surface will be in the same location as the stock wheel. You can bolt your original **1973-78** steering wheel directly to the 1973-78 steering column, no adaptor required!

Please Note: The 1947-54 column does NOT come with a neutral safety switch or shift indicator. Call ididit for info on adding. A stock 1960-66 wheel can NOT be used with a 1960-66 ididit column See page 46 for Chevy Truck installation kits

COMES WITH

- 8-POSITION TILT
- SELF-CANCELING TURN SIGNALS
- 4-WAY FLASHERS
- KNOBS & LEVERS
- 1955-59 INCLUDES RETRO STYLE KNOBS
- 55-78 COMES WITH NEUTRAL SAFETY SWITCH
Shift indicator not included
- 3 7/8" WIRING PLUG
- 73-78: 4 1/4" WIRING PLUG
- 47-59: 1" DD LOWER SHAFT
- 60-72: 3/4"-36 LOWER SHAFT
- 73-78: 1"-48 LOWER SHAFT
- 47-54 INCLUDES DASH MOUNT & FLOOR MOUNT
- 55-59 INCLUDES DASH MOUNT, MODEL SPECIFIC FLOOR MOUNT W/ GASKET & OE GEARBOX COVER
- 60-66 INCLUDES DASH LOCATING SLOT
- 67-72 INCLUDES WIRING HARNESS ADAPTOR
- 73-78 INCLUDES IGNITION & RELAY PACK

1947-54 CHEVY TRUCK **Includes**

Each 1947-54 column comes complete with a column specific under dash mount and classic floor mount for easy, hassle free installation.



	Paintable Steel	Chrome	Black Powder Coated	Brushed Aluminum	Polished Aluminum
1947-54	1130651010	1130651020	1130651051	1150651030	1150651040
1955-59	1140652010	1140652020	1140652051	1150652030	1150652040
1960-66	1140650010	1140650020	1140650051	1150650030	1150650040
1967-72	1140657010	1140657020	1140657051	1150657030	1150657040
1967-72 w/ Rack	1140658010	1140658020	1140658051	1150658030	1150658040
1973-78 w/ Key	1540760010	1540760020	1540760051	N/A	N/A
1973-78 w/Touch-N-Go	1546760010	1546760020	1546760051	N/A	N/A

If using an aftermarket fuel injection system with an ididit ignition column please call.

1955-59 CHEVY TRUCK **Includes**

The floor mount w/ gasket, under dash mount, and OE gearbox cover are essential for flawless installation, so that's why they are included with every 1955-59 Chevy truck column. We've always got you covered!



1955-1978 Chevy Truck Installation Kits

All the necessary components needed for flawless installation

DELUXE KITS - ORIGINAL HARNESS

For vehicles with an original factory harness, a 4-way flasher kit is included with these kits. This 4-way flasher kit will not only add safety to your vehicle, but will also convert your original wiring harness to the 3 7/8" plug found on your ididit column. These kits include all the necessary parts you will need to install the column to the gearbox. All you need to know is the diameter of the gearbox input shaft and the number of splines.

1960-62

Part # 3006001001

Manual Gearbox: 3/4"-30
Includes Coupler, Intermediate Shaft, Rag Joint & 4-way Flasher Kit

1963-66

Part # 3006001002

Manual Gearbox: 3/4"-30
Includes Coupler, Intermediate Shaft, Rag Joint & 4-way Flasher Kit

1960-62

Part # 3006002001

Manual Gearbox: 3/4"-36
Includes Coupler, Intermediate Shaft, Rag Joint & 4-way Flasher Kit

1963-66

Part # 3006002002

Manual Gearbox: 3/4"-36
Includes Coupler, Intermediate Shaft, Rag Joint & 4-way Flasher Kit

1960-66

Part # 3006001000

Manual/Power Gearbox: 3/4"-30
Includes Coupler, Intermediate Shaft & Rag Joint

1967-72

Part # 3007002000

Manual Gearbox: 3/4"-36
Includes U-Joint, Intermediate Shaft & Rag Joint

1977-78

Part # 3010007000

Manual/Power Assisted Gearbox: 3/4"-30
Includes U-Joint, Telescoping Shaft & Vibration Joint

1960-66

Part # 3006002000

Manual Gearbox: 3/4"-36
Includes Coupler, Intermediate Shaft & Rag Joint

1967-72

Part # 3007003000

Power Gearbox: 13/16"-36
Includes U-Joint, Intermediate Shaft & Rag Joint

1967-72

Part # 3007001000

Manual/Power Gearbox: 3/4"-30
Includes U-Joint, Intermediate Shaft & Rag Joint

1973-76

Part # 3010006000

Power Gearbox: 13/16"-36
Includes U-Joint, Telescoping Shaft & Vibration Joint

DELUXE KITS AFTERMARKET HARNESS

These kits include all the necessary parts you will need to install the column to the gearbox. Many aftermarket wiring companies offer replacement harnesses that incorporate a 4-way flasher unit as well as the flat 3 7/8" plug therefore, a 4-way flasher kit is not included in these kits. All you need to know before you order is the diameter of the gearbox input shaft and the number of splines.



1955-59 Installation Kit

Required for installation

This coupler is needed if you are using a stock box in your 1955-59 Chevy Truck. If using a rack & pinion or later model steering box, please call ididit for further information.

Part # 3000315249

Includes 3/4"DD x 1"DD Coupler

1955-59 Turn Signal Wiring

If your Chevy Truck was originally equipped with turn signals, you will need one of the following year specific wiring harness adaptors.

1955 Part # 3100035775

1956 Part # 3100035780

1957-59 Part # 3100035785

If your truck did NOT come with factory turn signals, use this plug to connect your wiring.

Female End Plug Part # 3106050010

ECONO KITS

We had the builder on a budget in mind when we designed this kit. The original joint and intermediate shaft are used. For the 1960-66 column, the shaft will need to be cut and modified to match the 3/4" DD coupler. The factory joint can be used for the 1967-72 column. Due to age, the original u-joint may be worn so please double check to make sure it is in good condition. We always recommend replacing the u-joint.

ORIGINAL HARNESS

1960-62

Part # 3001001001

Includes Coupler & 4-way Flasher Kit

1963-66

Part # 3001001002

Includes Coupler & 4-way Flasher Kit

AFTERMARKET HARNESS

1960-66

Part # 3000313449

Includes 3/4"-36 x 3/4"DD Coupler

Bronco

1974-1979

TILT FLOOR SHIFT

Designed to fit your Bronco and does NOT require modification to your original vehicle to install. This Ford Style column features all Ford wiring, a Ford top shaft and will easily attach to your stock gearbox with a new half rag joint installation kit. Installs in the same location as the old column using your original floor mount and new dash mount. Add your stock Bronco wheel and the gripping surface will be in the same location as the original.

	Paintable Steel	Chrome	Black Powder Coated
1974-75	1170845010	1170845020	1170845051
1976-77	1170855010	1170855020	1170855051
1978-79	1170815010	1170815020	1170815051

COMES WITH

- 8-POSITION TILT
- FORD SPLINED TOP SHAFT
- FORD TURN SIGNAL SWITCH
- FORD STYLE KNOBS & LEVERS
- 4-WAY FLASHERS
- 3/4"-36 LOWER SHAFT
- FORD WIRING CONNECTORS
- PRE-WELDED UNDER DASH MOUNT

TECH TIP

WHEN INSTALLING YOUR OEM STEERING WHEEL TO YOUR IDIDIT FORD STYLE COLUMN, THE OEM WHEEL MUST BE FOR THE SAME YEAR APPLICATION AS THE COLUMN. USE OF A DIFFERENT YEAR WILL RESULT IN DAMAGE TO THE TURN SIGNAL SWITCH.



74-75 Bronco Steel

74-75 Bronco Black

78-79 Bronco Chrome

TILT COLUMN SHIFT

This column shift has all the same great features as the floor shift, and is just as easy to install! The shift pattern on the column allows you to use either a 3 or 4-speed automatic transmission. This column utilizes the original transmission mounted neutral safety switch. A gear shift indicator is an option, but not included. A shift linkage (new or original) is required for installation and will attach to the lower shift arm provided on the column. Add your stock Bronco wheel directly to the column, no adaptor required.

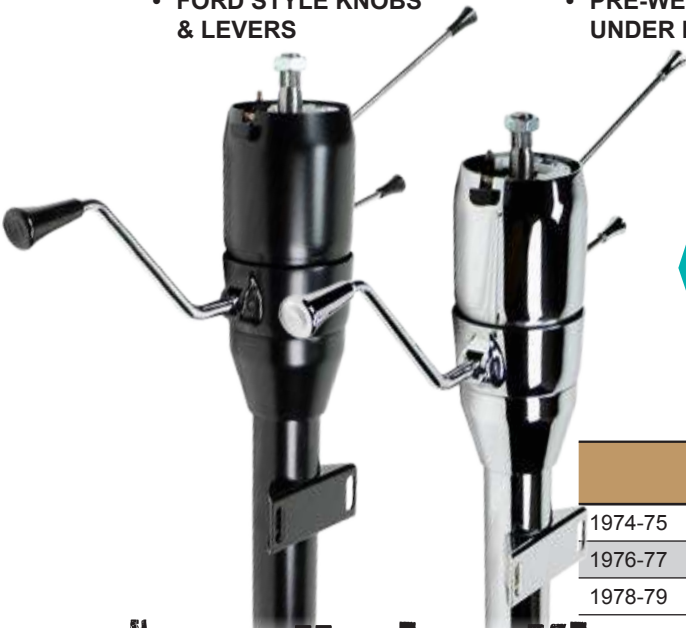

	Paintable Steel	Chrome	Black Powder Coated
1974-75	1130845010	1130845020	1130845051
1976-77	1130855010	1130855020	1130855051
1978-79	SEE PG 49 FOR INFORMATION ON THIS COLUMN		



FORD SHIFT INDICATORS

Get a Ford AOD, AODE, C4 or C6 shift indicator for your Ford transmission. See pg 57 for details.

Installation Kits

All the necessary components needed for flawless installation

1974-77
Part # 3000383400
 Includes 3/4"-36 Half Rag Joint

A new half rag joint is required for installation. The original rag joint was pressed onto the original column and cannot be removed.



1974-77
Part # 3000941000
 Includes replacement rubber disk for Rag Joint, nuts, bolts & washers.

Before installing, carefully inspect the rubber on the other half of the original rag joint to be sure it is all intact. If it is not, you will need to use this replacement.



1978-79
Part # 300053434
 Includes 3/4"-36 x 3/4"-36 Rag Joint



Ford 1/2 Ton Truck

1953-1979

FORD STYLE TILT FLOOR SHIFT

ididit built this Ford Style column specifically for those who are using stock Ford wiring and wish to use their original steering wheel. They feature all Ford wiring and a Ford top shaft and will work with your stock box or rack & pinion system. 1965-77 columns come with an extendable shaft which allows you to adjust the column length to fit your manual or power gearbox. Using a new rag joint installation kit, install your new steering column in place of the old. Add your stock Ford Truck wheel and the gripping surface will be in the same location as the original.

COMES WITH

- 8-POSITION TILT
- FORD SPLINED TOP SHAFT
- FORD TURN SIGNAL SWITCH
- FORD STYLE KNOBS & LEVERS
- PRE-WELDED UNDER DASH MOUNT
- FORD WIRING CONNECTORS
- 65-77: EXTENDABLE LOWER SHAFT
- 73-79 COMES WITH 4-WAY FLASHERS

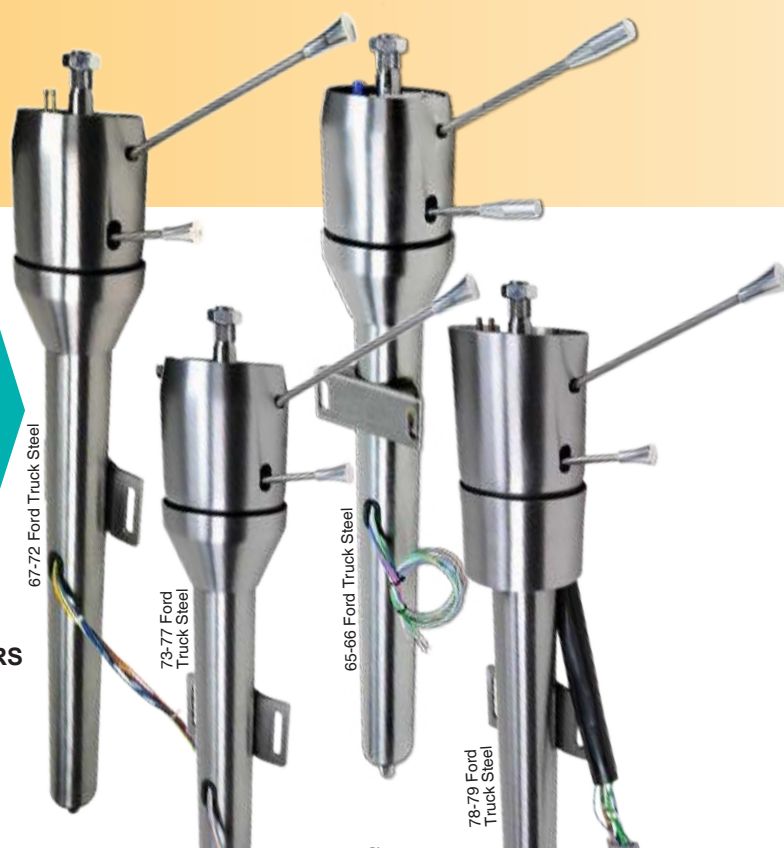

RAG JOINT Installation Kit

Required for Ford Style column installation

1965-77
Part # 3000053449
Includes 3/4"DD x 3/4"-36 Rag Joint

1978-79
Part # 3000053434
Includes 3/4"-36 x 3/4"-36 Rag Joint

	Paintable Steel	Chrome	Black Powder Coated
1965-66	1170825010	1170825020	1170825051
1967-72	1170735010	1170735020	1170735051
1973-77	1170755010	1170755020	1170755051
1978-79	1170815010	1170815020	1170815051

TECH TIP

WHEN INSTALLING YOUR OEM STEERING WHEEL TO YOUR IDIDIT FORD STYLE COLUMN, THE OEM WHEEL MUST BE FOR THE SAME YEAR APPLICATION AS THE COLUMN. USE OF A DIFFERENT YEAR WILL RESULT IN DAMAGE TO THE TURN SIGNAL SWITCH.



COMES WITH

- 8-POSITION TILT
- SELF-CANCELING TURN SIGNALS
- 4-WAY FLASHERS
- KNOBS & LEVERS
- 3 7/8" WIRING PLUG
- FEMALE END PLUG
- 53-56: 1" DD LOWER SHAFT
- 65-79: 3/4"-36 LOWER SHAFT
- 65-79 INCLUDES PRE-WELDED UNDER DASH MOUNT

Please Note: A stock Ford wheel will NOT bolt to these columns.

GM STYLE TILT FLOOR SHIFT

This GM based Ford Truck column is designed to fit your Ford Truck and features a GM upper shaft, along with a 3 7/8" Wiring Plug. Installs in the same location as the old column using your original floor mount, a pre-welded under dash mount and an ididit installation kit. 1953-56 columns will require a new swinger-style column drop, floor mount and u-joint. Using an adaptor, add an aftermarket wheel and the gripping surface will be in the same location as the original.

	Paintable Steel	Chrome	Black Powder Coated	Brushed Aluminum	Polished Aluminum
1953-56	1120800010	1120800020	1120800051	1070800030	1070800040
1965-66	1170820010	1170820020	1170820051	1070820030	1070820040
1967-72 Manual Box	1170730010	1170730020	1170730051	1070730030	1070730040
1967-72 Power Box	1170740010	1170740020	1170740051	1070740030	1070740040
1973-77	1170750010	1170750020	1170750051	1070750030	1070750040
1978-79	1170810010	1170810020	1170810051	1070810030	1070810040

A column for years 1957-64 is NOT available. Call ididit for recommendations.

67-72 Ford Truck Chrome

78-79 Ford Truck Chrome



GM STYLE TILT COLUMN SHIFT

This column shift has all the same great features as the floor shift, and is just as easy to install! The shift pattern on the column allows you to use either a 3 or 4-speed automatic transmission. The 1965-77 column shift column comes complete with a neutral safety switch, while the 1978-79 column utilizes the original transmission mounted neutral safety switch. A gear shift indicator is an option, but not included. A shift linkage (*new or original*) is required for installation and will attach to the lower shift arm provided on the column. Using an adaptor, add an aftermarket wheel and the gripping surface will be in the same location as the stock wheel.

Please Note: A stock Ford wheel will NOT bolt to these columns.

For 1965-66 columns: The Bendix box was frequently used as a replacement for the Saginaw box. If not using the stock steering box, a shorter length column may be required. Call ididit for details.

COMES WITH

- 8-POSITION TILT
- SELF-CANCELING TURN SIGNALS
- 4-WAY FLASHERS
- KNOBS & LEVERS
- 65-77 COMES WITH NEUTRAL SAFETY SWITCH
Shift indicator not included
- 3 7/8" WIRING PLUG
- FEMALE END PLUG
- 53-56: 1" DD LOWER SHAFT
- 65-79: 3/4"-36 LOWER SHAFT
- 65-79 INCLUDES PRE-WELDED UNDER DASH MOUNT

A COLUMN FOR YOUR 78-79 BRONCO

The 1978-79 column shift GM style Ford Truck steering column will also fit your 1978-79 Ford Bronco!



	Paintable Steel	Chrome	Black Powder Coated	Brushed Aluminum	Polished Aluminum
1953-56	1130800010	1130800020	1130800051	1150800030	1150800040
1965-66	1130820010	1130820020	1130820051	N/A	N/A
1967-72 Manual Box	1130730010	1130730020	1130730051	1150730030	1150730040
1967-72 Power Box	1130740010	1130740020	1130740051	1150740030	1150740040
1973-77	1130750010	1130750020	1130750051	1150750030	1150750040
1978-79	1130810010	1130810020	1130810051	1150810030	1150810040

A column for years 1957-64 is NOT available.

FORD SHIFT INDICATORS



Get a Ford AOD, AODE, C4 or C6 shift indicator for your Ford transmission. See pg 57 for details.

Installation Kits

FOR GM STYLE COLUMNS

All the necessary components needed for flawless installation

1953-56 FORD HALF-TON TRUCK

This column comes complete with a turn signal plug and horn relay that will convert the ididit wiring to your stock Ford wiring. To install, a swinger-style column drop will be required to secure the column to the dash, as well as a floor mount and u-joint.

If you are using your stock manual gearbox you will need to cut & modify this original shaft into what is referred to as a 3/4" DD shape.

If using a rack & pinion system a 3/4"DD x 36" Intermediate Shaft may be required. **Part # 3000409436**

1965-79 FORD HALF-TON TRUCK

Required for installation

Part # 3000053434

Includes 3/4"-36 x 3/4"-36 Rag Joint

The rag joint will act as a coupler and a vibration reducer between your steering column and gearbox.

A Female End Plug is included and will connect with the ididit wiring plug. The wires will simply be matched by function rather than color.

Jeep CJ5 & CJ7

1976-1986

TILT FLOOR SHIFT

Designed to fit your Jeep CJ5 or CJ7 and does NOT require modification to your original vehicle to install. This rugged and durable column comes complete with a keyed ignition. Installs in the same location as the old column using your original under dash mount and floor mount. Using an adaptor, add an aftermarket wheel and the gripping surface will be in the same location as the stock wheel. You can also bolt your stock Jeep CJ wheel directly to this column.

COMES WITH

- 8-POSITION TILT
- IGNITION & RELAY PACK
- SELF-CANCELING TURN SIGNALS
- 4-WAY FLASHERS
- KNOBS & LEVERS
- 3 7/8" & 4 1/4" WIRING PLUG
- 1" 48 LOWER SHAFT
- PROVISIONS FOR MOUNTING BRACKET



Upgrade to Touch-N-Go Start keyless ignition!

	Paintable Steel	Chrome	Black Powder Coated
1976-86 with Key	1520800010	1520800020	1520800051
1976-86 with Touch-N-Go	1526800010	1526800020	1526800051

If using an aftermarket fuel injection system with an ididit ignition column please call.



Installation Kits

All the necessary components needed for flawless installation

If using the original u-joint and shafting, no installation kit is required. However, if the shafting is worn or missing, we offer these replacement steering shafts for your Jeep CJ. Available as a direct replacement to match the original or upgrade to a steering shaft with a vibration reducer built right in.

REGULAR SHAFT

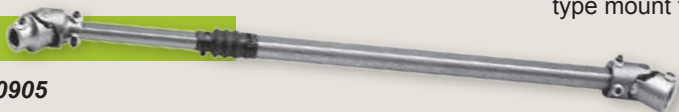

Manual Box **Part # 3000000905**

Power Box **Part # 3000000910**

VIBRATION REDUCER UPGRADE



Manual Box **Part # 3000000915**

Power Box **Part # 3000000920**

76-86 JEEP CJ MOUNT



Part # 2312600051

Are you replacing your original tilt column with a new ididit Jeep tilt column? If so, this mount will be required in order to bolt the new column in place of the old. The original tilt CJ column used a different type mount than the non-tilt CJ column.



Golf Cart

STEERING COLUMNS

Club Car



Golf carts aren't just for the golf course anymore! ididit's line of golf cart columns allows you to enjoy the luxury of tilt steering in your prized cart all while helping you with easy access in and out of your cart. Get the comforts of driving a Cadillac or Lincoln both on the course and around the neighborhood. And of course we didn't forget about your safety! We've built in self cancelling turn signals and four way flashers into the column so you'll have all the safety features of a standard vehicle.

Customize your cart with an ididit Golf Cart tilt steering column! We fit:

- ▶ CLUB CAR
- ▶ EZ GO
- ▶ YAMAHA



Available finishes include chrome or black powder coat. Add a stylish steering wheel and be the envy of the whole neighborhood. Enjoy the great outdoors, while enjoying the ease of a tilt steering column in your golf cart!

E-Z Go



Yamaha



Golf Cart

STEERING COLUMNS

CLUB CAR TILT

This column is made to fit your Club Car Cart and is designed to fit into the original dash support. For hassle free installation, the lower shaft of the column matches the spline of the original universal joint. The wiring slot is located at the lower end of the column, allowing the wiring to be easily hidden behind the dash. An installation kit is required to install the ididit Precedent Series columns.

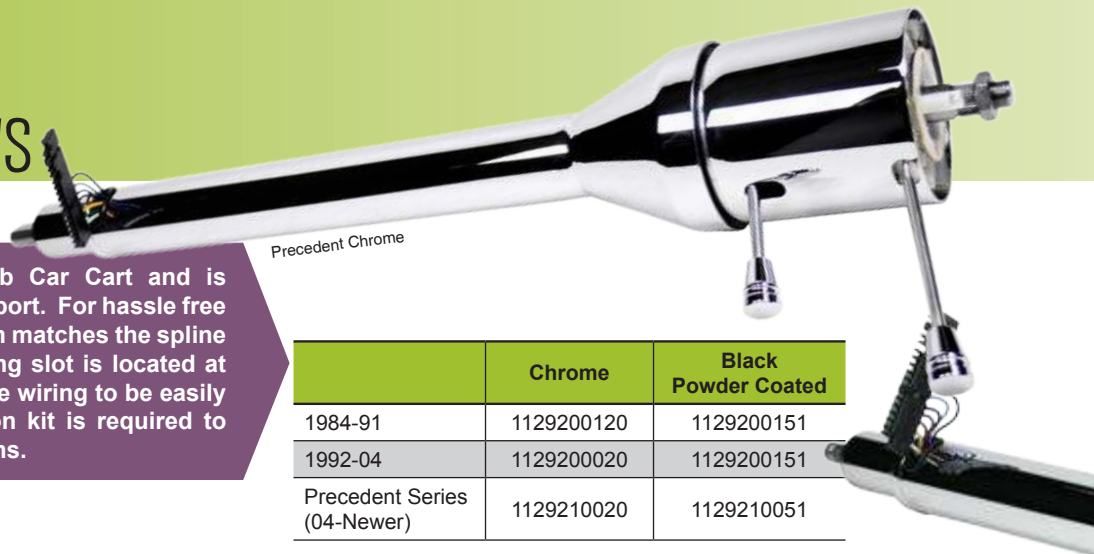

	Chrome	Black Powder Coated
1984-91	1129200120	1129200151
1992-04	1129200020	1129200151
Precedent Series (04-Newer)	1129210020	1129210051

E-Z GO TILT

This column is designed to fit into the original floor support of your E-Z Go TXT and is available with a 3-bolt or 4-bolt floor mount. Brand new to ididit's E-Z Go line is a tilt column for the 2008 & newer RXV. The wiring slot is located at the lower end of the each column, allowing the wiring to be easily hidden behind the dash.



	Chrome	Black Powder Coated
TXT 4-Bolt Floor Mount	1129400020	1129400051
TXT 3-Bolt Floor Mount	1129401020	1129401051
RXV (08-Newer) NEW	1129210020	1129210051

ALL IDIDIT GOLF CART COLUMNS COME WITH

- 8-POSITION TILT
- SELF-CANCELING TURN SIGNALS
- 4-WAY FLASHERS
- KNOBS & LEVERS
- 3 7/8" GM STYLE WIRING PLUG
- ACCEPTS 1969 OR NEWER GM PASSENGER CAR STEERING WHEELS & ADAPTORS

YAMAHA TILT

The original box on early model Yamaha carts were built with an integral shaft, making the column and gearbox a one piece unit. Therefore the gearbox will need to be modified before installing the ididit Yamaha tilt column. These columns come with the necessary coupler, as well as detailed instructions on how to modify the gearbox. Late model Yamaha's do NOT require any modifications to the gearbox. ididit's all new Yamaha Drive tilt column comes in two versions, one for aftermarket light kits and one for OE light kits. The wiring slot is located at the lower end of the column, allowing the wiring to be easily hidden behind the dash.



	Chrome	Black Powder Coated
Early model: G9, G14, G16 & G19	1129600020	1129600051
G22 and GMAX	1129600120	1129600151
Drive (07-Newer) NEW	1129210020	1129210051
Drive (07-Newer) w/OE Light Kit NEW	1129220020	1129220051

STRAIGHT SERIES GOLF CART COLUMNS

Get the "Hot Rod" look for your golf cart with ididit's all new Classic Straight steering column available for select golf cart models. Comes with self-canceling turn signals, 4-way flashers & our standard dress-up kit.



	Chrome	Black Powder Coated
Club Car Precedent	1019010020	1019010051
EZ-GO RXV	1019010020	1019010051
Yamaha Drive	1019010020	1019010051

Installation Kits

All the necessary components needed for flawless installation

CLUB CAR - PRECEDENT

Precedent 2004-Newer

Part # 301202009

Includes U-Joint, Shaft, Floor Mount, 4-way Flasher Kit



Precedent 2004-Newer using LED Tailights

Part # 3014020010

Includes U-Joint, Shaft, Floor Mount, Flasher Kit for LED's

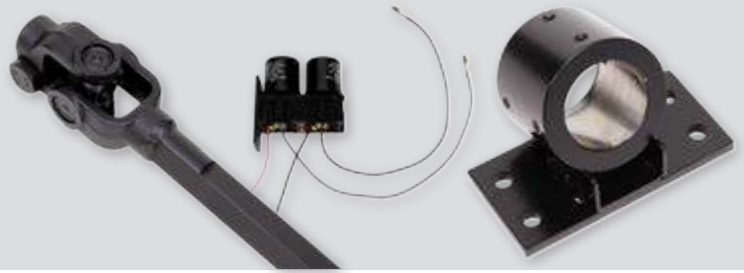

EZ-GO - RXV

RXV 2008-Newer

Part # 3012021009

Includes U-Joint, Shaft, Floor Mount, 4-way Flasher Kit



RXV 2008-Newer using LED Tailights

Part # 3014021010

Includes U-Joint, Shaft, Floor Mount, Flasher Kit for LED's



4-WAY FLASHER KIT

Add the safety of turn signals & 4-way flashers to your golf cart with this wiring adaptor kit.

Part Number: 3100500741



YAMAHA - DRIVE

Drive 2007-Newer using LED Tailights

Part # 3015020010

Includes Floor Mount, Flasher Kit for LED's

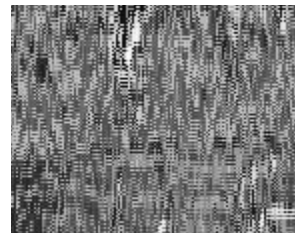
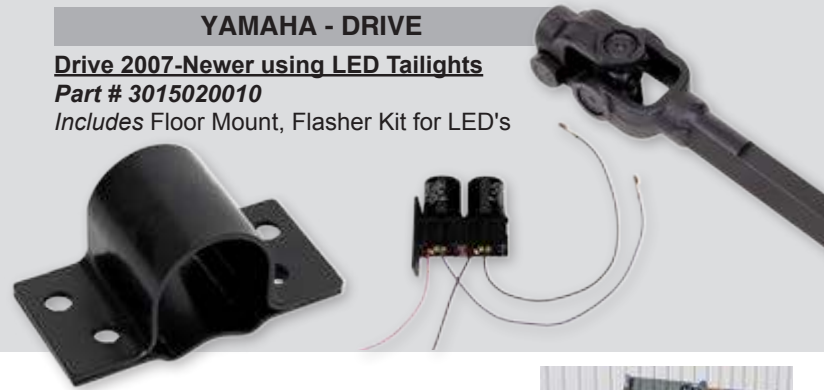

Add-Ons & Accessories

FOR YOUR STEERING COLUMN



Floor Mounts

pg 55



Column Drops

pg 56



Shift Indicators

pg 57



You will save yourself time, money and hassle if you plan ahead and choose the column add-ons and accessories you'll need before ordering your ididit steering column. We can install cruise control, dimmer, wipers or a neutral safety switch to your ididit column right when you order (labor charges may apply), saving you the hassle of having to ship your column back to our facility after you've received it. Planning ahead will greatly increase the success of your project.

Call us with any questions you may have and we will be more than happy to help you choose what you'll need to customize your ididit column.



Cruise Control

pg 57



Dimmer/Wiper Kits

pg 58



Touch-N-Go Start

pg 58



Cable Shift Linkage Kits

pg 59



Dress-Up Kits

pg 60



Wheel Adaptors

pg 61



SHIFT LEVER ARMS

We can all be a bit tough on our toys sometimes, that's why ididit offers these great shift arm replacements for your ididit Column Shift column.



SWEPT STYLE

Part # 2504300120



SWEPT STYLE LONG

Part # 2504300220

S-STYLE

Part # 2504300020



STRAIGHT STYLE

Part # 2504300320



Floor Mounts

A floor mount is essential for proper steering column installation. Don't overlook this important safety feature! ididit floor mounts are available in a variety of sizes to fit your column.

SWIVEL BALL FLOOR MOUNT

The ididit swivel ball floor mount allows you to precisely position your steering column right where you want it. You can move it up, down, side to side and everything in between. A trim ring for the engine compartment side is included along with all the necessary hardware for installation. Available in polished aluminum. For aftermarket columns only.



If using a swivel ball floor mount with a chrome or black powder coated column please use the part numbers listed in the table below. These floor mounts are bored out more due to the thickness of the column finishes.



Paintable Steel Columns		Chrome & Black Powder Coated Columns	
1 3/4" Polished Aluminum	2400500040	1 3/4" Polished Aluminum	2400550040
2" Polished Aluminum	2401500040	2" Polished Aluminum	2401550040
2 1/4" Polished Aluminum	2402500040	2 1/4" Polished Aluminum	2402550040

ADJUSTABLE FLOOR MOUNT W/ TRIM KIT

This kit will not only secure your column, but it will also add style and class to your interior! Kit includes an adjustable floor mount and polished aluminum trim ring with hardware. Add one of our stylish vinyl boots to cover the mount (sold separately.) Choose from 4 different colors!

1 3/4" Adjustable Trim Kit	2400800010
2" Adjustable Trim Kit	2401800010
2 1/4" Adjustable Trim Kit	2402800010
Black Boot for Adjustable Trim Kit	2405810010
Bone Boot for Adjustable Trim Kit	2405820010
Brown Boot for Adjustable Trim Kit	2405830010
Grey Boot for Adjustable Trim Kit	2405840010

Vinyl Boot available in:

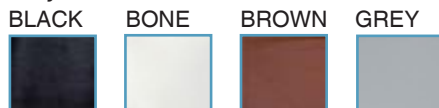

ADJUSTABLE FLOOR MOUNT

This inexpensive steel floor mount will safely secure your column at the floor board or firewall and can adjust to fit most angles, up or down.



1 3/4"	2400300010
2"	2401300010
2 1/4"	2402300010



CLASSIC CHEVY FLOOR MOUNT

The Classic Chevy Floor mount uses the two original holes in the inside floor of your 55-57 Chevy to mount the bracket. Comes complete with a clamp to secure the bracket to the column. *This floor mount is strongly recommended for all Chevy Tri-Five Installations.*

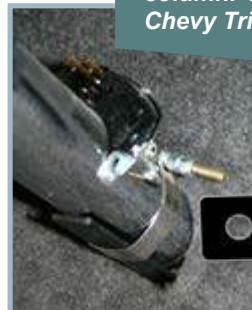

2" Classic Chevy	2401400010
2 1/4" Classic Chevy	2402400010



COLLAPSIBLE FLOOR MOUNT WITH PLATE

This mount is designed to mount a steering column to the floor or firewall & can be installed on either side of the firewall. It includes extra material to allow you to cover any holes left behind by the existing steering column. Trim to fit.

1 1/2" Part # 2401120010 • 1 3/4" Part # 2401220010
2" Part # 2401020010 • 2 1/4" Part # 2402020010

COLLAPSIBLE FLOOR MOUNT

This floor mount is designed to mount a steering column to the floor or firewall, and can be installed on either side of the firewall.

1 1/2" Part # 2401110010 • 1 3/4" Part # 2401210010
2" Part # 2401010010 • 2 1/4" Part # 2402010010



Column Drops

IDIDIT - 2 1/4"

Designed for tubes 2 1/4" in diameter.
Mounting bolts are set 2 5/8" apart.

Drop Length	Brushed AL	Polished AL
2 1/2"	2302370030	2302370040
3 1/2"	2303370030	2303370040
4 1/2"	2304370030	2304370040
5 1/2"	2305370030	2305370040
6 1/2"	2306370030	2306370040
7 1/2"	2307370030	2307370040



IDIDIT II - 2"

Designed for tubes 2" in diameter.
Mounting bolts are set 2 5/8" apart.

Drop Length	Brushed AL	Polished AL
2 1/2"	2302470030	2302470040
3 1/2"	2303470030	2303470040
4 1/2"	2304470030	2304470040
5 1/2"	2305470030	2305470040
6 1/2"	2306470030	2306470040
7 1/2"	2307470030	2307470040



1 3/4"

Designed for tubes 1 3/4" in diameter.
Mounting bolts are set 2 5/8" apart.

Drop Length	Brushed AL	Polished AL
2 1/2"	2302570030	2302570040
3 1/2"	2303570030	2303570040
4 1/2"	2304570030	2304570040
5 1/2"	2305570030	2305570040
6 1/2"	2306570030	2306570040
7 1/2"	2307570030	2307570040



GM - 2 3/8"

Designed for tubes 2 3/8" in diameter.
Mounting bolts are set 2 5/8" apart.

Drop Length	Brushed AL	Polished AL
2 1/2"	2302170030	2302170040
3 1/2"	2303170030	2303170040
4 1/2"	2304170030	2304170040
5 1/2"	2305170030	2305170040
6 1/2"	2306170030	2306170040
7 1/2"	2307170030	2307170040



VAN - 2"

Designed for tubes 2" in diameter.
Mounting bolts are set 2 5/8" apart.

Drop Length	Brushed AL	Polished AL
2 1/2"	2302270030	2302270040
3 1/2"	2303270030	2303270040
4 1/2"	2304270030	2304270040
5 1/2"	2305270030	2305270040
6 1/2"	2306270030	2306270040
7 1/2"	2307270030	2307270040



1932 FORD

Designed for the 1932 Ford dash.
Mounting bolts are set 2 5/8" apart.
Standard length is 5" from center.

Hole Size	Brushed AL	Polished AL
GM 2 3/8"	2305180030	2305180040
Van 2"	2305280030	2305280040
ididit 2 1/4"	2305380030	2305380040
ididit II 2"	2305480030	2305480040
1 3/4"	2305580030	2305580040



1965-66 FORD F-100

Mounting slots are set
3 5/8" apart

Hole Size	Brushed AL	Polished AL
2"	2311000030	2311000040
2 1/4"	2311500030	2311500040



STEEL WELD-ON

Designed to weld onto your 2" diameter steering
column and under your dash for a custom setup.
Mounting slots are set 1 3/4" apart. (slotted 1 7/8")

Drop Length	Steel
3"	2303490010
4"	2304490010
5"	2305490010
7"	2307490010



GM 1969 OR NEWER UNDERDASH MOUNT

Mounting slots are set 5 1/4" apart. (slotted 1")

Hole Size	Brushed AL	Polished AL
1 3/4"	2310300030	2310300040
2"	2310000030	2310000040
2 1/4"	2310500030	2310500040



1947-54 CHEVY TRUCK

ididit's 1947-54 Chevy Truck Dash Bracket is designed to
affix your column drop to your dash. Part # 2301050010



Column Add-Ons



SHIFT INDICATOR W/ POINTER

Just Shift It! ididit offers easy to install, acrylic shift indicators for your column shift column. Made from high quality acrylic, these indicators can fit any 4" diameter column. Comes complete with matching acrylic pointer and easily attaches to your column with adhesive tape. Available for your 3 speed or 4 speed automatic transmission.



3 Speed	2600000010
4 Speed	2600050010
Ford AOD 1980-93	2600060010
Ford AODE 1992 & Up	2600070010
Ford C4 & C6	2600071010

TECH TIP IDIDIT ACRYLIC INDICATORS WILL NOT FIT IN OEM HOUSINGS.

SHIFT INDICATOR W/ POINTER & HOUSING

Add some flair to your acrylic indicator with a sleek aluminum housing! ididit's shift indicator with housing comes complete with acrylic indicator, matching aluminum pointer and two short screws that are used to affix the housing and indicator to your column. Available for your 3 speed or 4 speed automatic transmission.



Ford AOD
Black Powder Coated



C4 & C6
Polished Aluminum

	3 Speed	4 Speed	Ford AOD 80-93	Ford AODE 92 & Up	C4 & C6
Chrome	2600200020	2600250020	2600260020	2600270020	2600271020
Black Powder Coated	2600200051	2600250051	2600260051	2600270051	2600271051
Brushed Aluminum	2600200030	2600250030	2600260030	2600270030	2600271030
Polished Aluminum	2600200040	2600250040	2600260040	2600270040	2600271040

RIGHT HAND DRIVE SHIFT INDICATORS

Our popular acrylic shift indicators are also available for your right hand drive column. Available with or without an aluminum housing, these high quality indicators will work great with your 3 speed or 4 speed automatic transmission.



	3 Speed	4 Speed
Indicator w/ Pointer	2600001010	2600051010

Indicator w/ Pointer & Housing	3 Speed	4 Speed
Chrome	2600201020	2600251020
Black Powder Coated	2600201051	2600251051
Brushed Aluminum	2600201030	2600251030
Polished Aluminum	2600201040	2600251040

Cruise Control

Call us today to find out how you can save yourself a whole lot of time and money by having ididit install your cruise control lever while we assemble your column! *Labor charges may apply.*

Please note: Cruise Control units can NOT be returned if the wires have been cut.



FOR NON COMPUTERIZED ENGINES

Part # 3100020000

This Rostra electric servo unit uses solid state electronics for accuracy and reliability. The servo and control unit are small and easy to mount. Kit includes pulse generator and cruise control lever.

Running an LS engine or "throttle by wire"? Call ididit for details.



FOR COMPUTERIZED ENGINES

Part # 3100010000

This Rostra unit gathers information from your car's computer, so no external sensors are required. Adjustable for 2,000, 4,000 or 8,000 pulses per mile. Small and easy to mount. Kit includes a cruise control lever.

CRUISE CONTROL COVERS

Dress-up your cruise control lever with this stylish aluminum cover!



Brushed Aluminum	2501000030
Polished Aluminum	2501000040
Brushed Aluminum Right Hand Drive	2501050030
Polished Aluminum Right Hand Drive	2501050040

Column Add-Ons

DIMMER KIT

ididit's dimmer kit features a momentary switch and relay pack. The relay pack makes the switch an "on/on" that will toggle your headlights from high beam to low beam and back again. You have the option of putting the switch on either your tilt or turn signal lever.



Kit with Turn Signal Lever Brushed	3100030030
Kit with Turn Signal Lever Polished	3100030040
Kit with Tilt Lever Brushed	3100040030
Kit with Tilt Lever Polished	3100040040

WIPER KIT

ididit's wiper kit features an on/off function and comes complete with lever and relay pack. You have the option of putting the switch on either your tilt or turn signal lever, the choice is yours.



Kit with Turn Signal Lever Brushed	3100050030
Kit with Turn Signal Lever Polished	3100050040
Kit with Tilt Lever Brushed	3100060030
Kit with Tilt Lever Polished	3100060040

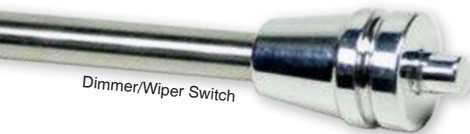

Save time & money by having ididit install your dimmer/wiper lever while your column gets assembled! *Labor charges may apply.*

FEMALE END PLUG

This end plug is the mate to the 3 7/8" wire plug found on your ididit column. Eight crimp-on terminals are included and easily attach to your wires and are then clipped into the plug. *Part # 3106050010*

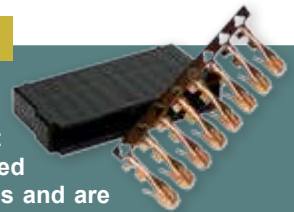

FAST/MAST RELAY PACK

If you are using a FAST or MAST aftermarket fuel management system you will be required to use this special relay pack with your ididit column with ignition. This relay pack allows the computer to stay on when your ignition is between crank and run, without losing signal and causing the system to shut down. If you are using your original fuel management system this relay pack is NOT necessary. *Part # 3100038100*

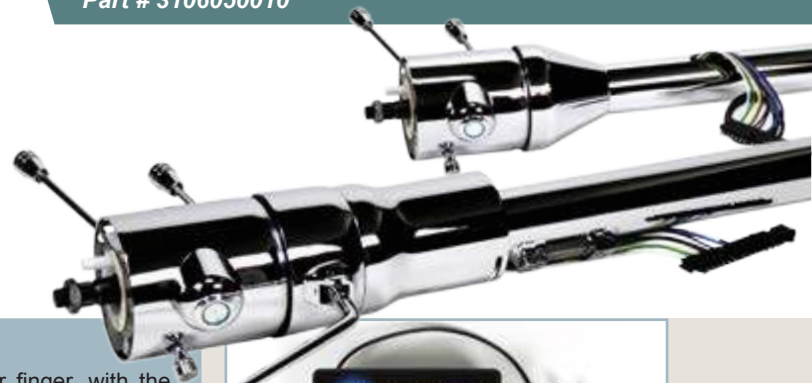

Touch-N-Go Start

Get the most advanced keyless ignition technology at the tip of your finger, with the Touch-N-Go Start keyless ignition system for your ididit steering column. This is the industry's FIRST touch sensitive start system and features a 22mm aluminum button (25mm with column mount) with multi-color interactive LED lights that always let you know what mode it's in. There are no moving components to wear out, ensuring years of outstanding performance.

You'll never have to use your keys again! This system can be used as a simple start button system or you can utilize more advance functions, such as keyless entry. Just stick your programmable key fob in your pocket and the system will sense your approach, automatically unlocking your door as you get close and locking it up as you leave (the system only responds when the key fob is in range). For added safety, this system can also be programmed to turn on your dome lights as you approach.

Available with most ididit tilt steering columns, or replace your stock in-dash ignition with the Touch-N-Go Start System. *Part # 2600670100*



TOUCH-N-GO START FEATURES

- STARTS YOUR CAR WITH THE SIMPLE TOUCH OF A BUTTON.
- COMES WITH 2 KEY FOBs WITH UP TO 4 PROGRAMMABLE CHANNELS.
- COMES WITH A CONTROL BOX SMALL ENOUGH TO FIT JUST ABOUT ANYWHERE.
- HAS A PROXIMITY RANGE OF 2 - 15 FT.
- SIMULATES THE FIVE COMMON GM IGNITION POSITIONS: OFF, ACCESSORY, ON, CRANK, AND RUN.
- FOR ADDED SECURITY, A VALET SWITCH IS INCLUDED ALLOWING YOU TO OVERRIDE THE KEY FOB SYSTEM.
- NO INTERNAL RELAYS. USES MOSFET TECHNOLOGY.
- 22MM DASH MOUNT OR 25MM COLUMN MOUNT ALUMINUM TOUCH BUTTON WITH LED DISPLAY IS FULLY CUSTOMIZABLE, WITH MULTIPLE COLORS TO CHOOSE FROM. LED LIGHTS CAN BE DIMMED.

Cable Shift Linkage Kits



KIT CONTENTS

ididit's award winning cable shift linkage kits all contain a 6ft standard shift cable, a column bracket for your ididit or stock column and a transmission bracket. Give us a call if you need a custom kit made for your application.

Cable Shift Linkage Kit w/ stock Column

Cable Shift Linkage Kit w/ ididit Column



GM Transmission Bracket except early powerglide or 4L80



Chrysler 727 & 904 Transmission Bracket



Ford AOD Transmission Bracket



Ford C-4 Transmission Bracket



Ford C-6 Transmission Bracket



Ford 4R70W/AODE Transmission Bracket



6ft Standard Shift Cable Custom lengths are available



ididit Column Bracket Used with your ididit column



Stock Column Bracket & Horseshoe Bracket Used with your stock column

GM TRANSMISSION KITS

Go www.ididitinc.com/accessories/CableShiftLinkage.com for complete list of GM transmissions these kits will work with.

For a 2" ididit column Part # 2801000010

Includes 6 ft shift cable, 2" ididit column bracket, GM transmission bracket.

For a 2 1/4" ididit column Part # 2802000010

Includes 6 ft shift cable, 2 1/4" ididit column bracket, GM transmission bracket.

For a 2" GM stock column Part # 2801050010

Includes 6 ft shift cable, 2" stock column bracket & horseshoe bracket, GM transmission bracket.

C-4 TRANSMISSION KITS

For a 2" ididit column* Part # 2801300010

Includes: 6 ft shift cable, 2" ididit column bracket, Ford C-4 transmission bracket.

For a 2 1/4" ididit column* Part # 2802300010

Includes: 6 ft shift cable, 2 1/4" ididit column bracket, Ford C-4 transmission bracket.

For a 2 1/4" Ford stock column Part # 2802350010

Includes: 6 ft shift cable, 2 1/4" stock column bracket & horseshoe bracket, Ford C-4 transmission bracket.

C-6 TRANSMISSION KITS

For a 2" ididit column* Part # 2801400010

Includes: 6 ft shift cable, 2" ididit column bracket, Ford C-6 transmission bracket.

For a 2 1/4" ididit column* Part # 2802400010

Includes: 6 ft shift cable, 2 1/4" ididit column bracket, Ford C-6 transmission bracket.

For a 2 1/4" Ford stock column Part # 2802450010

Includes: 6 ft shift cable, 2 1/4" stock column bracket & horseshoe bracket, Ford C-6 transmission bracket.

AOD TRANSMISSION KITS

For a 2" ididit column* Part # 2801500010

Includes: 6 ft shift cable, 2" ididit column bracket, Ford AOD transmission bracket.

For a 2 1/4" ididit column* Part # 2802500010

Includes: 6 ft shift cable, 2 1/4" ididit column bracket, Ford AOD transmission bracket.

For a 2 1/4" Ford stock column Part # 2802550010

Includes: 6 ft shift cable, 2 1/4" stock column bracket & horseshoe bracket, Ford AOD transmission bracket.



FORD 4R70W/AODE TRANSMISSION KITS

For a 2" ididit column* Part # 2801600010

Includes 6 ft shift cable, 2" ididit column bracket, Ford 4R70W/AODE transmission bracket.

For a 2 1/4" ididit column* Part # 2802600010

Includes 6 ft shift cable, 2 1/4" ididit column bracket, Ford 4R70W/AODE transmission bracket.

For a 2 1/4" Ford stock column Part # 2802650010

Includes 6 ft shift cable, 2 1/4" stock column bracket & horseshoe bracket, Ford 4R70W/AODE transmission bracket.

HALF MOON SHIFT LEVER



Shift around that pesky brake! The ididit Half Moon Shift Lever will maneuver around your brake pedal. Comes complete with bushing and the hardware needed to mount to your ididit steering column.
2": Part # 2600700052
2 1/4": Part # 2600700152

CHRYSLER 727 & 904 TRANSMISSION KITS

For a 2" ididit column* Part # 2801700010

Includes 6 ft shift cable, 2" ididit column bracket, Chrysler 727 & 904 transmission bracket.

For a 2 1/4" ididit column* Part # 2802700010

Includes 6 ft shift cable, 2 1/4" ididit column bracket, Chrysler 727 & 904 transmission bracket.

For a 2" Chrysler stock column Part # 2801750010

Includes 6 ft shift cable, 2" stock column bracket & horseshoe bracket, Chrysler 727 & 904 transmission bracket.

* THESE KITS WILL NOT WORK WITH 1ST GENERATION IDIDIT STEERING COLUMNS. 1st generation columns have square lever holes and do not come with a serial number sticker located on the inside of the upper sleeve.

Knobs & Levers

DRESS-UP KITS

Each tilt dress-up kit includes turn signal lever with knob, tilt lever with knob and 4-way flasher knob. Non-tilt dress-up kits come with turn signal lever with knob and 4-way flasher knob only.

Please note: Deco style knobs are only available in polished aluminum finish.



PUSH-IN STYLE DRESS-UP KIT

- KIT INCLUDES A TURN SIGNAL LEVER WITH KNOB, A TILT LEVER WITH KNOB AND A 4-WAY FLASHER KNOB.
- THE TURN SIGNAL LEVER SIMPLY SNAPS INTO PLACE.
- FITS MOST 1977 AND NEWER GM COLUMNS.
- COMES IN STANDARD STYLE ONLY.

Brushed Aluminum Part # 2500010030

Polished Aluminum Part # 2500010040

GEAR SHIFT KNOBS

Replace your old worn out plastic gear shift knob with a sparkling new ididit knob! These gear shift knobs will match your ididit dress-up kit perfectly and attach with a single set screw. They are designed to be used with GM and ididit gear shift handles only. A set screw is supplied to secure all shift knobs.



Knob Style	Chrome	Brushed AL	Polished AL	Blk Powder Coated
Standard	2500500020	2500500030	2500500040	2500500051
Retro	2520500020	2520500030	2520500040	2520500051
Deco	N/A	N/A	2510500040	N/A
Early Ford	2500500120	2500500130	2500500140	2500500151
Late Ford	2500500220	2500500230	2500500240	2500500251

TILT DRESS-UP KIT

- INCLUDES TURN SIGNAL LEVER WITH KNOB, TILT LEVER WITH KNOB AND A 4-WAY FLASHER KNOB.
- THE TURN SIGNAL LEVER IS FLATTENED AND ATTACHES TO THE COLUMN WITH A SINGLE SCREW.
- FITS 1969 AND NEWER GM AND CHRYSLER COLUMNS.



Knob Style	Chrome	Brushed AL	Polished AL	Blk Powder Coated
Standard	2500000020	2500000030	2500000040	2500000051
Retro	2520000020	2520000030	2520000040	2520000051
Deco	N/A	N/A	2510000040	N/A
Early Ford	2500260020	2500260030	2500260040	2500260051
Late Ford	2500261020	2500261030	2500261040	2500261051

A 4-way flasher knob does NOT come in the Ford style dress-up kits

TILT/TELESCOPING DRESS-UP KIT

- INCLUDES TURN SIGNAL LEVER WITH KNOB, TILT LEVER WITH KNOB AND A 4-WAY FLASHER KNOB.
- THE TURN SIGNAL LEVER IS THREADED AND SCREWS INTO PLACE.
- FITS 63-76 GM TILT/TELESCOPING & EARLY IDIDIT UNIVERSAL SERIES STEERING COLUMNS.



Knob Style	Chrome	Brushed AL	Polished AL	Blk Powder Coated
Standard	2500250020	2500250030	2500250040	2500250051
Retro	2520250020	2520250030	2520250040	2520250051
Deco	N/A	N/A	2510250040	N/A

NON-TILT DRESS-UP KIT

- INCLUDES TURN SIGNAL LEVER WITH KNOB AND A 4-WAY FLASHER KNOB.
- THE TURN SIGNAL LEVER IS FLATTENED AND ATTACHES TO THE COLUMN WITH A SINGLE SCREW.
- FITS 1969 AND NEWER GM AND CHRYSLER COLUMNS.



Knob Style	Chrome	Brushed AL	Polished AL	Blk Powder Coated
Standard	2500100020	2500100030	2500100040	2500100051
Retro	2520100020	2520100030	2520100040	2520100051
Deco	N/A	N/A	2510100040	N/A

SINGLE KNOBS

ididit offers single dash knobs that will add flair to your dash and will match your Standard or Deco column dress-up kit. These dash knobs can be used for your headlight switch, your wiper switches and so much more!

STANDARD STYLE

	Chrome	Brushed AL	Polished AL	Blk Powder Coated
10-32	2503300020	2503300030	2503300040	2503300051
10-24	2503200020	2503200030	2503200040	2503200051
1/4" Bore	2503100020	2503100030	2503100040	2503100051
3/16" Bore	2503000020	2503000030	2503000040	2503000051

DECO STYLE

10-32 Polished AL Part # 2513300040 **10-24** Polished AL Part # 2513200040 **1/4" Bore** Polished AL Part # 2513200040 **3/16" Bore** Polished AL Part # 2513200040

Steering Wheel Adaptors

9 BOLT ADAPTOR

These 9-bolt pattern adaptors will match aftermarket wheels from Lecarra, Billet Specialties, Budnik, Colorado Custom, and more! Standard size is 2.5" deep.



Steering wheel adaptors are made to adapt the 3, 5, 6, or 9-bolt patterns of a steering wheel to the tapered, splined top shaft of a steering column. All ididit adaptors will fit most ididit columns as well as most 1969 or newer GM passenger car columns and are secured in place with a single nut. A horn wire is included with most adaptors.

	Chrome	Brushed AL	Polished AL	Black Powder Coated
Standard No Horn	2201300020	2201300030	2201300040	2201300051
Standard w/Horn	2201310020	2201310030	2201310040	2201310051

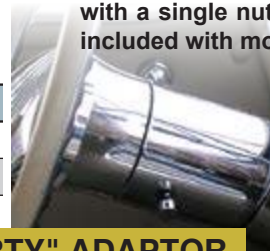

9 BOLT "SHORTY" ADAPTOR

The ididit 9-bolt shorty adaptor is uniquely designed to move the bolting surface of the steering wheel 2" closer to the dash, giving you that extra "belly room". Caution should be taken when using this adaptor. Please note the clearance needed between the wheel and turn signal lever, and/or shift arm. Modifications may be necessary for proper installation. Chrome Part # 2201100020
Polished Aluminum Part # 2201100040



5 & 6 BOLT ADAPTORS

5 & 6-bolt adaptors for Grant and Lecarra come with a horn button. Momo, Dino, Nardi, Diablo and Corvette adaptors do not because the horn button is already included on the steering wheel. Standard size is 2.5" deep.



	Chrome	Brushed AL	Polished AL	Blk Powder Coated
5 Bolt Grant	2207310020	2207310030	2207310040	2207310051
6 Bolt Lecarra	2202310020	2202310030	2202310040	2202310051
6 Bolt Momo	2202320020	2202320030	2202320040	2202320051
6 Bolt Dino/Diablo	2202330020	2202330030	2202330040	2202330051
6 Bolt Nardi	2202340020	2202340030	2202340040	2202340051
6 Bolt 1963-66 & 68 Corvette	2202350020	2202350030	2202350040	2202350051
6 Bolt 1956-62 Corvette	2202360020	2202360030	2202360040	2202360051

	Chrome	Brushed AL	Polished AL	Black Powder Coated
3 Bolt STD	2208310020	2208310030	2208310040	2208310051
3 Bolt "Bell"	2209300020	2209300030	2209300040	2209300051
3 Bolt "Bell" with Horn	2209310020	2209310030	2209310040	2209310051
CON2R	2209330020	2209330030	2209330040	2209330051

3 BOLT ADAPTOR

Grant and Wheel Shoppe are the most popular applications for the ididit standard 3-bolt adaptor. Add the convenience of a horn button for your Pete & Jake's or other bell style wheel with the ididit "Bell" style 3-bolt adaptor. Standard size is 1.25" deep.



1955-68 HORN KIT

ididit's 1955-68 Horn Kit has everything you need to adapt most 55-68 GM stock steering wheels to your ididit steering column. Comes complete with aluminum trim ring, horn contact plate, spring, pin and retainer. Part # 2612100040

To see how it works go to ididitinc.com and click on the videos link!



1965 IMPALA/CHEVELLE & 1966 NOVA HORN KIT

This Horn kit will adapt a stock 1965 Impala and Chevelle (not the SuperSport) steering wheel to your ididit steering column as well as a stock 1966 Nova wheel. Comes complete with aluminum trim ring, horn contact plate, spring, pin and retainer. Part # 2612100240





Types of Shafts

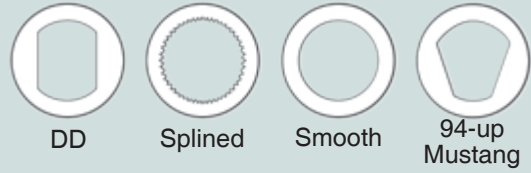

UNIVERSAL JOINTS

Single universal joints work smoothly up to 35 degrees

Single u-joints available in the following styles:

- Smooth bore both ends
- Smooth bore x spline or DD
- Spline or DD x spline or DD
- Available in a variety of finishes



SINGLE U-JOINT

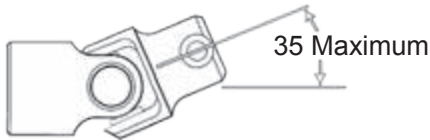
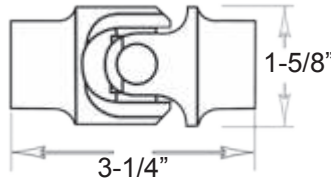

Double universal joints will work smoothly up to 70 degrees

Double u-joints available in the following styles:

- Smooth bore both ends
- Smooth bore x spline or DD
- Spline or DD x spline or DD
- Available in a variety of finishes

DOUBLE U-JOINT

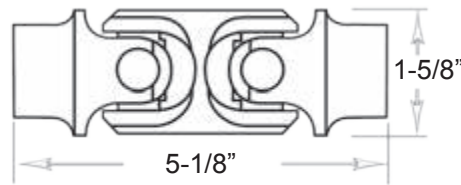

VIBRATION REDUCERS

- Used to stop pulsations from the power steering pump.
- A vibration joint will work smoothly up to 35 degrees.
- Rag joints are available and **must be mounted straight!** Any angle of deflection on a rag joint could result in a loss of steering.



RAG JOINT

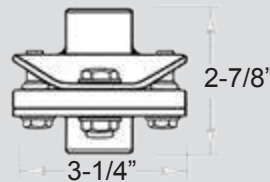

RAG JOINT:
BOLT SPACING = 2.5"
DIAMETER = 3.25"

U-JOINT VIBRATION REDUCER

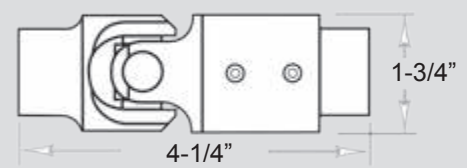

STRAIGHT COUPLERS

- Coupler and adaptor must be welded
- Most sizes available
- **Pre-Welded coupler/adapters available from ididit:**
 - 1"48 x 3/4"DD
 - 1"DD x 3/4"DD
 - 3/4"36 x 3/4"DD



Adaptor



Coupler



Pre-Welded Coupler

SHAFTS

Steel Shafts:

- 2" - 36" Splined both ends
- 2" spline on each end
- 18" DD Shaft
- 36" DD Shaft



Stainless Steel:

available in polished or unpolished

- 4" - 36" Splined both ends
- 1" spline on each end
- 22" DD Shaft
- 36" DD Shaft

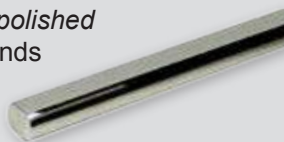

SUPPORT BEARINGS

- Support bearings must be used when using more than 2 u-joints.
- 3/4" DD shafts will work in round support bearings.
- Double u-joints would be counted as 2 u-joints.



Aluminum Shaft Support



Rod End Bearing

- Available in a variety of finishes



Steel Support Bearing
(cut to fit)



Vega



525/122



600



700



Mustang



For Splined Shafts with a Flat
Count the number of splines of
half of the circumference
and double that
number for total

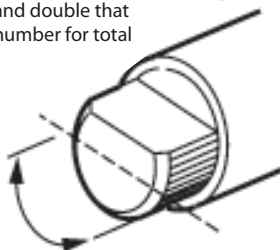

Popular Splines And Double D Applications

All Measurements can be +/- .015". Precision measuring equipment should be used.

Column Application	Description	Size	Diameter	Splines	Double D Flats
GM Column	Small Spline	3/4"-36	.735	36	
	Large Spline	1"-48	.985	48	
	Small Double D	3/4" DD	.750		.550
	Large Double D	1" DD	.993		.790
Ford Column	Small Spline	3/4"-36	.735	36	
	Small Double D	3/4" DD	.750		.550
	Large Double D	1" DD	.993		.790
Other Manufacturers	International	1"-48	.985	48	
	Ididit-aluminum	1"-48	.985	48	
	Ididit-steel	1" DD	.993		.790
	Flaming River	1" DD (standard)	.993		.790
Borgeson	3/4"-36	.735		36	
Boxes & Racks Application	Description	Size	Diameter	Splines	Double D Flats
Chrysler Box or Rack	Chrysler	9/16"-17	.562	17	
	Chrysler	9/16"-26	.562	26	
	Chrysler	9/16"-36	.562	36	
	Chrysler	5/8"-36 C*	.625	36	
	Chrysler	11/16"-36	.687	36	
	Chrysler	3/4"-36	.735	36	
	Chrysler	13/16"-36	.812	36	
	Chrysler Omni	9/16"-26	.562	26	
GM Manual Box	Corvair	5/8"-36	.625	36	
	Vega (model 140)	5/8"-36	.625	36	
	Corvette ('63-67)	3/4"-36	.728	36	
	Corvette ('68-83)	3/4"-30	.735	30	
	('58-64)	3/4"-36	.735	36	
	Model 122 ('65-85)	3/4"-30 or 3/4"-36	.730	30 or 36	
	Model 525 ('86 & later)	3/4"-30	.728	30	
GM Power Box	Model 605 ('78-84)	3/4"-30	.728	30	
	Model 700 ('77 & earlier)	13/16"-36	.812	36	
	Model 700 ('78 & later)	3/4"-30	.728	30	
GM Rack	'79 & later	5/8"-36	.625	36	
	Some Models	3/4"-30	.728	30	
	Corvette ('84 & later)	17mm DD	.670		.570
	Fiero	17mm DD	.670		.570
Ford Box	Manual & Power	3/4"-36	.735	36	
Ford Rack	Mustang & Pinto Manual	9/16"-26	.562	26	
	Mustang & Pinto Power	3/4"-36	.735	36	
	94-Later Mustang	3/4"-V	.740		
Other Manufacturers	Borgeson 55-57 Chevy Conversion	18mm DD	.708		.635
	Borgeson 58-64 Chevy Conversion	17mm DD	.670		.570
	Borgeson Chevy II Nova Conversion	11/16"-36	.687	36	
	Borgeson Corvette Conversion Box	18mm DD	.708		.635
	Borgeson Ford Conversion Boxes	11/16"-36	.687	36	
	Heidt's Super Ride Rack	9/16"-26	.562	26	
	Woodward Rack	3/4"-20	.735	20	
	Nissan	11/16"-36	.687	36	
	Jaguar & MGB	3/4"-48	.750	48	
	Unisteer Manual Rack	9/16"-26	.562	26	
	Volkswagen Rabbit Rack	11/16"-40	.687	40	
	VW Rabbit Rack Diesel	3/4"-36	.735	36	

*The 5/8"-36 Chrysler is not interchangeable with 5/8"-36.

FREQUENTLY ASKED QUESTIONS

WHY AREN'T PRICES INCLUDED IN THE CATALOG?

We are a manufacturer and we strongly support our dealer network. We refer our customers to our dealers because we know they will get the most competitive price on our products. Therefore, we don't list prices in our catalog so we can focus on product education.

HOW DO I GET MY HORN TO WORK?

First you must identify which horn system your vehicle is using.

Take note: Putting power to a GM horn wire will fry the contact spring inside the column faster than you can disconnect it. This is a ground based system.

One Wire System

1. This is the standard setup on all of ididit GM based steering columns, as well as most 1969 or newer GM columns.
2. The horn wire will connect from the spade connector in the center of the horn button to the inside of the white plastic tube (horn cam) on the top of the column.
3. ididit includes a horn wire with most of our steering wheel adaptors.
4. You can buy them directly from GM. (**part # 9769448 or 474102**)
5. Horn wires are available from ididit, inc. (**part # 2620000014**)

Horn Plunger (metal pin) System

1. Horn plungers were used in many pre-69' GM columns.
2. The horn plunger will fit inside the white plastic tube (horn cam) located on top of the column.
3. As the horn is depressed, the metal plunger acts as a conductor to transfer the ground.
4. This horn kit is available from ididit, inc. (**part # 2620000010**)

Ford System

1. Most, but not all, original Ford wiring systems will use a two wire system (power in and power out) coming out of the column. If you have a single wire system in your Ford column, this is ground based (like our GM style column) and is waiting for a ground.
2. You can NOT mix a one wire horn system with a two wire horn system without a relay. Using a relay will combine the two wire system with the one wire as a ground trigger. For further explanation please refer to the instructions on the relay. Improper wiring of the relay will fry the contact spring faster than you can blink! (**Horn Contact Repair Kit: 2620000010**)
3. Relays are available from ididit, inc. as well as most auto part stores (**part number: 2620000013**).

WHY DOES MY HORN SOUND ALL THE TIME?

1. Somewhere in the wiring system the black wire is going to the ground. This should be an open circuit waiting for the ground.
2. The screw that fastens your turn signal lever in place may be loose, allowing it to touch the bottom side of the horn cam, causing the horn to sound. Make sure this screw is tight.

WILL AN IDIDIT COLUMN SHIFT WORK WITH A 2, 3, OR 4 SPEED AUTOMATIC TRANSMISSION?

Yes, with the exception of early Powerglides, as they have a reverse pattern transmission.

I CAN'T GET INTO PARK OR LOW. WHAT AM I DOING WRONG?

The length of the pivots must be the same on the transmission as it is on the steering column (the column is 2 7/8" and the transmission linkage should be the same). When you set up your linkage, start with the column and transmission in neutral. This will give you a central location to start from, allowing you to split any variation in the low gear and park detents.

HOW DO I GET MY COLUMN DROP OVER MY WIRES?

Our polisher is always proud of this question. By removing the two bolts from the bottom side of the column drop, the drop will split apart at the center of the hole. The split is nearly invisible. See page 4 for our column drop diagram.

WHAT SHOULD I DO FOR A NEUTRAL SAFETY SWITCH?

Many of our Retrofit columns come with a neutral safety switch however, our Universal columns do not. A transmission mounted neutral safety switch is one alternative. A column-mounted switch can be added to your column, but the location of the switch must be determined before purchasing. *Additional charges will apply.*

To add a neutral safety switch to your ididit column follow these simple steps:

1. The switch must be attached to the column. Some machining is required and must be done by ididit, inc. Installing your own neutral safety switch to the column will void any warranty.
2. We will need to know where the neutral safety switch will be installed.
 - The switch must be installed below the wiring slot.
 - We need to know the distance from the top outer housing of the column, as well as the exact position for rotation (on a clock face). Be sure to determine these measurements as if you were sitting in the vehicle (3 o'clock is towards the passenger). *Standard labor charges will apply. Please see the custom column drawings which can be found on our website at www.ididitinc.com/guides-and-tips.*

WHAT ADAPTOR DO I NEED TO FIT AN IDIDIT COLUMN?

The top shaft of most ididit columns is the same size as the 1969 or newer GM passenger car column (pre-air bag). This is also the most popular adaptor used in the aftermarket industry. All ididit, inc. adaptors will match this spline. Our standard 3-bolt Adaptors are 1-1/4" deep and our standard 5, 6 and 9-bolt adaptors are 2-1/2" deep.

Ford style ididit columns have a Ford top shaft and will require an adaptor for the same year as your application. Use of a different year will result in damage to the turn signal switch.

We also carry a horn kit to adapt most stock 1955-68 GM wheels to your ididit column . Go to page 61 for more information.

HOW SHOULD I PREP MY COLUMN FOR PAINTING OR POWDER COATING?

In order to prevent rusting, all raw steel columns are wiped down with WD-40 before leaving our facility. Use a non-abrasive cloth and some type of grease or wax remover to remove the WD-40. Please note: our paintable steel columns are made from a mild steel material and will rust without proper primer and paint.

When prepping your column we DO NOT advise you to disassemble your column. It is important that the column is fully supported at both ends. DO NOT suspend/hang the column by one end only, as the column is heavy and may fall. We recommend using 2 pieces of 2x6 board 12 inches long so the column can be rotated safely while having both ends supported. The top board should have a 9/16 inch hole cut out in the center to support the shaft and the bottom board should have either 1 inch or 3/4 inch hole depending on the shaft size.

When masking your column, you will need to close off the top of the column, but masking off the tilt and turn signal holes is not. Some people prefer to tuck a piece of paper behind the holes, but once again it is not completely necessary. We do recommend removing the orange wire grommet and then taping off the rest of the wires that exit the tube. It tends to be difficult to get good coverage in the tilt portion of the column. This alternate surface has been primed by us at the factory to insure the metal is sealed. You should tilt the column both ways and paint as much of this surface as possible.

One question we get quite often is; Can ididit columns can be clear coated? We have learned from years of painting display columns that lacquer, enamel, polyurethane and epoxy clear coats will NOT seal.

Please call ididit, inc. if you will be powder coating your column at your own powder coater, because it *will* have to be disassembled due to the powder coating process. When placing your column order let us know and we will send you just the parts that need to be powder coated and we will then re-assemble the column and send the finished piece back to you.

DOES MY COLUMN NEED A GROUND?

Yes, the horn requires a ground in order to work. Normally the under dash or floor mount will provide an adequate ground but that is not always true with a fiberglass car. In this case, you should utilize the existing grounding strip located under the dash mount to secure a grounding connection.

IDIDIT APPAREL & GIFTS

T-SHIRTS

100% Cotton
Short Sleeve
Sizes: S-M-L-XL-2XL-3XL
Colors: Black, Tan



1/4 ZIP SWEATSHIRT

Sizes: S-M-L-XL-2XL-3XL
Colors: Black only



DICKIES WORK SHIRT

Available in Long or Short Sleeve
Button up
Sizes: M-L-XL-2XL-3XL
Colors: Tan only



EMBROIDERED LOGO HATS

Embroidered with ididit logo
Colors: Washed Denim
Washed Red
One size fits all



IDIDIT KEYCHAIN



IDIDIT MUGS

Black ceramic mug with 2 color ididit logo

Diamond plate travel mug with red ididit logo



THE IDIDIT FAMILY



Front Row
(from left to right)
Maria, Charlie,
George, Rick,
Rosa

Second Row
(from left to right)
Tom, John, Gil,
Joe, Dereck,
Vinnie

Back Row
(from left to right)
Joe, Drew, Don,
Lenny, Brandon,
Jeff, Ken, Steven

Not Pictured
Darlynn



Marty
Sales Manager



Lorri
Customer Service



Kellie
Outside Sales Manager



George
Sales



Derek
Sales/Tech



Stacey
Receptionist



Terry
Tech Guru



Barry
Shipping



Celeste
Inventory Controller



Stacy
Inventory Clerk



Jon
Purchaser



Bob
Plant Manager



Greg
Machining Coordinator



Megan
Marketing Coordinator



Madison
Marketing Assistant



Angie
Human Resources



Mary Sue
Controller



Nikki
Accounting Assistant



ORDERING & SHIPPING INFO

Orders

Orders may be placed by phone Monday-Friday from 8:30 am until 5:30 pm and Saturdays from 10:00 am until 2:00 pm EST (Summer Hours: closed on Saturdays Memorial Day-Labor Day.) You may also place your order by Fax (517) 424-7293 or Email (sales@ididitinc.com) 24 hours a day, seven days a week. We are more than happy to answer any questions you may have regarding our products, product installation, or anything else that might help make your project simple and easy.

Shipping/Handling

All orders will be shipped by UPS Ground, unless otherwise specified. For instance, we have found using the US Postal Service is often the most economical choice for shipments into Canada. A \$5.00 handling charge will be applied to orders under \$100.00, and a \$7.00 handling charge for orders over \$100.00.

Returns

Merchandise must be in resalable condition. Any merchandise returned for a refund must be returned within 30 days of purchase and is subject to inspection by ididit, inc. A 20% restocking fee may apply. **ELECTRICAL PARTS CANNOT BE RETURNED.** ididit, inc. DOES NOT accept COD returns.

Liability

Because ididit, inc. has no control over installation and/or use of it's products, ididit, inc. will not be held liable for personal, property, legal or financial damages or claims stemming from the use or misuse of any product we manufacture or sell. The purchaser assumes all responsibility for safety, performance and applicability of these products. No warranty is expressed or implied. We will repair or replace any product found to be defective, subject to our inspection.



Terms

Payments can be made using Visa, MasterCard, Discover, Money Order or Cashiers Check. Personal checks will be accepted for orders totaling less than \$100.00. Payment through UPS COD is available for shipments in the USA. Advance payment is required for our international friends.

Damages

All ididit, inc. products are inspected and determined to be in perfect condition prior to leaving our facility. If you receive damaged products, please note with the carrier and then notify ididit, inc. immediately!

Return Authorization

All merchandise to be returned **MUST** have an authorization number. To receive authorization number, call us at (517) 424-0577 during normal business hours and explain the reason for the return. All returns must include a copy of the original invoice, authorization number and a brief written explanation for the return. Items purchased through an ididit dealer must be returned where purchased.





Since 1986, ididit, inc. has been the industry leader in steering column innovation. We have dedicated ourselves to produce the finest quality, 100% American Made products. ididit offers state of the art columns for your Street Rod, Muscle Car, Classic Truck, Mopar and so much more! We also produce specialty columns for a multitude of applications, such as your prized golf cart. When it's time to put a steering column in your vehicle, make it the best...make it an ididit.

We are located in Tecumseh, MI just east of the beautiful Irish Hills region and 15 miles from Michigan International Speedway. Stop by our showroom or give us a call!



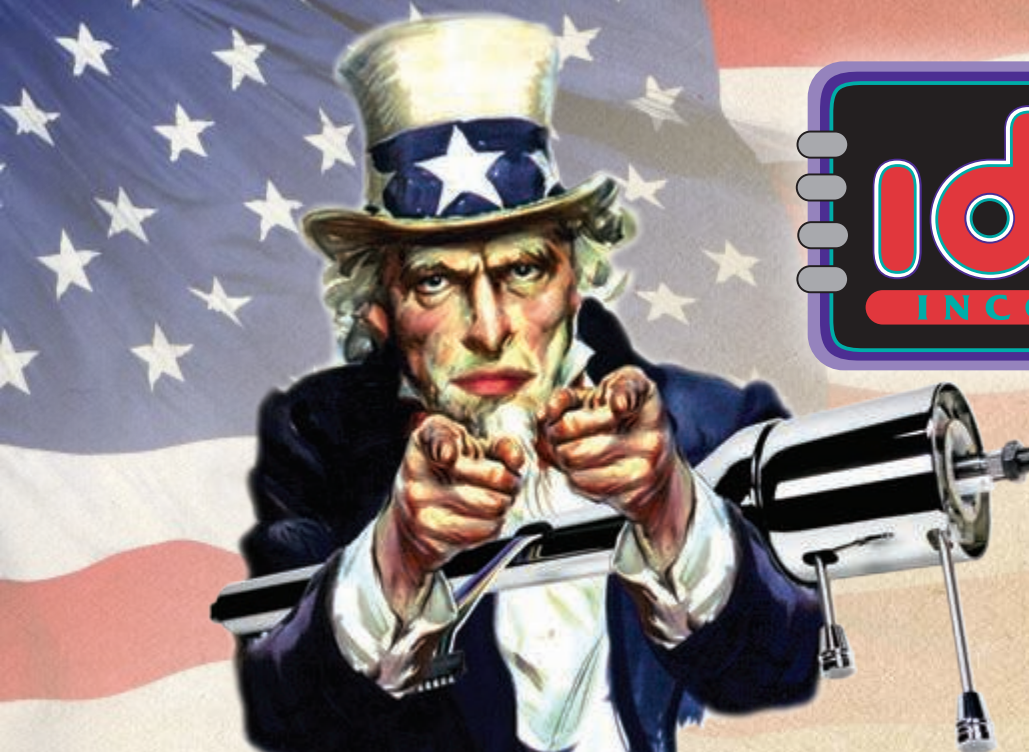

**ALL COLUMNS
ARE NOT
CREATED EQUAL!**

www.ididitinc.com

ididit WANTS YOU TO BUY AMERICAN

CALL US FOR THE NEAREST COLUMN RECRUITING STATION

HOW IT ALL BEGAN...

Ken Callison hit the streets cruisin' suburban Detroit the second he got his license in hand. His first rod was an ex-chicken coop 1938 Chevy Coupe that he lovingly returned to life and is still on the streets today. Jane, the woman he would marry, grew up in a family without a car. By the time she got her license she was **READY** for her own brand of crusin' in her 1960 Falcon "Flower Wagon". ***THIS marriage was meant to be.***

In 1970, after serving in the Navy as a machinist, Ken went to work for Ford Motor Company. Over the years he continued to show interest and talent for machining trick parts for him and his friends' projects. Life was predictable until 1983 when a fellow Ypsilanti Area Street Rods member asked him to machine a billet aluminum steering column. Ken went on to produce the first of many thousands of ididit columns and demand grew quickly. By 1986 Ken and his son Scott were in a steadily growing business.

One day while at a swap meet, a man approached Ken and Scott's display, picked up one of the machined aluminum parts and asked who had made it. Ken replied, "I did." The man picked up another part and asked the same question, to which again he replied, "I did." After

several repetitions, the man said, "For the last time, who made these parts?" Ken, his patience running short, told him, "For the last time I DID! I made everything on this table." At that point the disbeliever looked Ken up and down and said, "No way. You're not smart enough to make stuff this nice." Ken had had enough. He reached across the table, grabbed the offender by his lapels and yelled - "Look here! #\$\$!# I DID IT ! ! ! !"
The company now had a name.

Jane joined ididit in 1987 when the growth of the company demanded full time management and has held down the office since. Ken retired from Ford in 1994, forsaking the security of a "job" in order to pursue the dream he and his talented family had carved for themselves.

Today the family - Ken, Jane, Scott, Kim, and their staff continue to offer 100% American Made products found in some of the finest street rods and specialty cars in the world today.

