

# FEHLING INSTRUMENTS

HCR MICS INSTRUMENTS

HCR MICS INSTRUMENTE

FEHLING  
INSTRUMENTS

---

Hanauer Landstr. 7A · 63791 Karlstein/Germany · [www.fehling-instruments.de](http://www.fehling-instruments.de)

☎ +49 (0) 61 88 – 95 74.40 · 📠 +49 (0) 61 88 – 95 74.45 · ✉ [info@fehling-instruments.de](mailto:info@fehling-instruments.de)

---

CERAMO® HCR

MICS INSTRUMENTS  
MICS INSTRUMENTE

FORCEPS / PINZETTEN



	 1,2 x 8 mm $\frac{1}{4}$		 1 x 10 mm $\frac{1}{4}$		 3 x 15 mm $\frac{1}{4}$		
	SUTURE NAHT				VALVE KLAPPE		
Total Length Gesamtlänge	280 mm	350 mm	345 mm	400 mm	280 mm	350 mm	400 mm
Shaft Diameter Schaftdurchmesser	∅ 3,5 mm	∅ 3,4 mm	∅ 5,0 mm	∅ 5,0 mm	∅ 5,0 mm	∅ 5,0 mm	∅ 5,0 mm
Item No. Artikelnummer	MRC-1	MSP-7	MRA-5	MRA-5L	MQZ-8	MRA-0 MRQ-3 <sup>1)</sup> MQZ-9 <sup>2)</sup>	MRA-0L MRQ-3L <sup>1)</sup> MQZ-9L <sup>2)</sup>



	 $\frac{1}{4}$			 $\frac{1}{4}$
	RUSSIAN RUSSISCH			TISSUE GEWEBE
Total Length Gesamtlänge	280 mm	350 mm	400 mm	350 mm
Shaft Diameter Schaftdurchmesser	∅ 5,0 mm	∅ 5,0 mm	∅ 5,0 mm	∅ 3,0 mm
Item No. Artikelnummer	MQZ-5	MRQ-5	MRQ-5L	MSQ-4

1) WITH LOOK / MIT SPERRE  
2) DE BAKEY-TOOTHING / DE BAKEY-ZAHNUNG

CERAMO® HCR

MICS INSTRUMENTS  
MICS INSTRUMENTE

FORCEPS / PINZETTEN

	 <p>45° 1,5 x 11 mm</p>		 <p>1,5 x 11 mm</p>			
	NON-TRAUMATIC ATRAUMATISCH					
Total Length Gesamtlänge	350 mm	400 mm	280 mm	350 mm	400 mm	
Shaft Diameter Schaftdurchmesser	Ø 5,0 mm	Ø 5,0 mm	Ø 5,0 mm	Ø 5,0 mm	Ø 5,0 mm	
Item No. Artikelnummer	MRG-7	MRG-7L	MSO-6	MRG-6	MRG-6L	

	 <p>2,8 x 15 mm</p>					
	NON-TRAUMATIC ATRAUMATISCH					
Total Length Gesamtlänge	290 mm	350 mm	280 mm	350 mm	400 mm	430 mm
Shaft Diameter Schaftdurchmesser	Ø 3,0 mm	Ø 3,0 mm	Ø 5,0 mm	Ø 5,0 mm	Ø 5,0 mm	Ø 5,0 mm
Item No. Artikelnummer	MRC-2D	MSP-8D	MRN-0 MRN-0B 1)	MRA -3 MRA-3B 1) MRA-3U 2)	MQZ-2 1) MRA-3L	MRD-4

1) WITH LOOK / MIT SPERRE  
2) NO CERAMO / KEIN CERAMO\*



CERAMO® HCR

MICS INSTRUMENTS  
MICS INSTRUMENTE

FORCEPS / PINZETTEN



	NON-TRAUMATIC ATRAUMATISCH				
Total Length Gesamtlänge	350 mm	400 mm	280 mm	350 mm	400 mm
Shaft Diameter Schaftdurchmesser	Ø 5,0 mm	Ø 5,0 mm	Ø 5,0 mm	Ø 5,0 mm	Ø 5,0 mm
Item No. Artikelnummer	MRA-4	MRA-4L	MQY-6K	MQY-6	MQY-6L

	NON-TRAUMATIC ATRAUMATISCH		
Total Length Gesamtlänge	280 mm	350 mm	400 mm
Shaft Diameter Schaftdurchmesser	Ø 5,0 mm	Ø 5,0 mm	Ø 5,0 mm
Item No. Artikelnummer	MQY-7K	MQY-7	MQY-7L



CERAMO® HCR

MICS INSTRUMENTS  
MICS INSTRUMENTE

FORCEPS / PINZETTEN

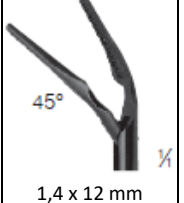
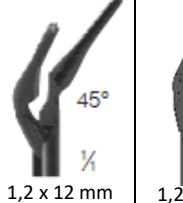
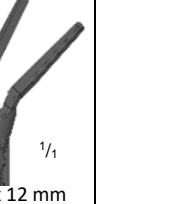

	 1,2 x 15 mm $\frac{1}{4}$	 1,4 x 12 mm $\frac{1}{4}$ 45°	 1,2 x 12 mm $\frac{1}{4}$ 45°	 1,2 x 12 mm $\frac{1}{4}$	
	NON-TRAUMATIC ATRAUMATISCH				
Total Length Gesamtlänge	240 mm	290 mm	280 mm	280 mm	350 mm
Shaft Diameter Schaftdurchmesser	Ø 3,4 mm	Ø 3,5 mm	Ø 3,5 mm	Ø 3,5 mm	Ø 3,4 mm
Item No. Artikelnummer	MRC-2K	MRC-2	MRC-0	MRC-3	MSP-9



	 $\frac{1}{4}$ DELICATE / FEIN	 $\frac{1}{4}$ DELICATE / FEIN	 $\frac{1}{4}$ 2,8 x 15 mm
	NON-TRAUMATIC ATRAUMATISCH		
Total Length Gesamtlänge	350 mm	350 mm	400 mm
Shaft Diameter Schaftdurchmesser	Ø 3,0 mm	Ø 3,0 mm	Ø 3,4 mm
Item No. Artikelnummer	MSP-9D	MSQ-3	MRB-7



CERAMO® HCR

MICS INSTRUMENTS  
MICS INSTRUMENTE

NEEDLE HOLDERS / NADELHALTER (WITH LOOK / MIT SPERRE)



	 1 x 10 mm <b>max. 6x0</b>			 2 x 10 mm <b>max. 5x0</b>		
	TCM					
Total Length Gesamtlänge	250 mm	280 mm	350 mm	240 mm	280 mm	360 mm
Shaft Diameter Schaftdurchmesser	Ø 3,5 mm	Ø 3,4 mm	Ø 3,4 mm	Ø 3,5 mm	Ø 3,5 mm	Ø 3,5 mm
Item No. Artikelnummer	MRM-4	MRC-5	MSP-6	MRC-4K	MRC-4	MRC-4L



	 1 x 10 mm <b>max. 5x0</b>		 2 x 10 mm <b>max. 5x0</b>		 3 x 10 mm <b>max. 3x0</b>			
	TCM							
Total Length Gesamtlänge	340 mm	400 mm	340 mm	400 mm	280 mm	340 mm	400 mm	430 mm
Shaft Diameter Schaftdurchmesser	Ø 5,0 mm	Ø 5,0 mm	Ø 5,0 mm	Ø 5,0 mm	Ø 5,0 mm	Ø 5,0 mm	Ø 5,0 mm	Ø 5,0 mm
Item No. Artikelnummer	MRB-3	MRB-3L	MRB-2	MRB-2L	MRG-8	MRB-1 MRB-1U <sup>1)</sup>	MRB-1L	MRD-5

1) WITHOUT LOOK / OHNE SPERRE

CERAMO® HCR

MICS INSTRUMENTS  
MICS INSTRUMENTE

NEEDLE HOLDERS / NADELHALTER (WITH LOOK / MIT SPERRE)

	 1,5 mm <i>max. 5x0</i>		 2,5 x 10 mm <i>max. 2x0</i>		 3 x 10 mm <i>max. 2x0</i>		
	TC Ryder		TC				
Total Length Gesamtlänge	350 mm	400 mm	340 mm	400 mm	280 mm	340 mm	400 mm
Shaft Diameter Schaftdurchmesser	Ø 5,0 mm	Ø 5,0 mm	Ø 5,0 mm	Ø 5,0 mm	Ø 5,0 mm	Ø 5,0 mm	Ø 5,0 mm
Item No. Artikelnummer	MSO-1	MSO-1L	MRT-1	MRT-1L	MRT-6	MRG-9 MRD-0 <sup>1)</sup>	MRG-9L

	 3 x 10 mm <i>max. 2x0</i>				
	TC				
Total Length Gesamtlänge	280 mm	400 mm	340 mm	350 mm	440 mm
Shaft Diameter Schaftdurchmesser	Ø 5,0 mm	Ø 5,0 mm	Ø 5,0 mm	Ø 5,0 mm	Ø 5,0 mm
Item No. Artikelnummer	MSO-5	MSO-5L	MRG-2S MRB-9 <sup>1)</sup>	MRG-2	MRG-2L <sup>1)</sup>

1) WITHOUT LOOK / OHNE SPERRE









2/3

CERAMO® HCR

MICS INSTRUMENTS  
MICS INSTRUMENTE

SCISSORS / SCHEREN

							
	VALVE KLAPPE						
Total Length Gesamtlänge	280 mm	350 mm	280 mm	350 mm	280 mm	350 mm	450 mm
Shaft Diameter Schaftdurchmesser	Ø 5,0 mm	Ø 5,0 mm	Ø 5,0 mm	Ø 5,0 mm	Ø 5,0 mm	Ø 5,0 mm	Ø 5,0 mm
Item No. Artikelnummer	MQZ-7	MRT-2	MSO-2	MRT-3	MSO-3	MRD-7	MRD-7L

							
	VALVE KLAPPE						
Total Length Gesamtlänge	350 mm	280 mm	350 mm	400 mm	280 mm	350 mm	400 mm
Shaft Diameter Schaftdurchmesser	Ø 5,0 mm	Ø 5,0 mm	Ø 5,0 mm	Ø 5,0 mm	Ø 5,0 mm	Ø 5,0 mm	Ø 5,0 mm
Item No. Artikelnummer	MRA-7	MSO-4	MRT-5	MRT-5L	MQZ-6	MSO-8	MSO-8L





2/3









CERAMO® HCR

MICS INSTRUMENTS  
MICS INSTRUMENTE

SCISSORS / SCHEREN

							
	DISSECTION PRÄPARATION			MICRO DISSECTION MIKRO PRÄPARATION			
Total Length Gesamtlänge	280 mm	350 mm	430 mm	280 mm	350 mm	280 mm	350 mm
Shaft Diameter Schaftdurchmesser	Ø 5,0 mm	Ø 5,0 mm	Ø 5,0 mm	Ø 3,4 mm	Ø 3,4 mm	Ø 3,5 mm	Ø 3,4 mm
Item No. Artikelnummer	MRQ-0	MRA-6	MRD-6	MSP-1D	MRC-6D	MRC-6	MSP-1

							
	VASCULAR GEFÄSS						
Total Length Gesamtlänge	280 mm	280 mm	280 mm	335 mm	345 mm	345 mm	400 mm
Shaft Diameter Schaftdurchmesser	Ø 3,5 mm	Ø 3,5 mm	Ø 3,5 mm	Ø 5,0 mm	Ø 5,0 mm	Ø 5,0 mm	Ø 5,0 mm
Item No. Artikelnummer	MRC-7	MRC-8	MRM-0	MRA-9	MRA-8B	MRA-8	MRA-8L







2/3





CERAMO® HCR

MICS INSTRUMENTS  
MICS INSTRUMENTE

SCISSORS / SCHEREN

	 25° 1/1	 45° 1/1	 60° 1/1			
	VASCULAR GEFÄSS					
Total Length Gesamtlänge	290 mm	320 mm	290 mm	320 mm	290 mm	320 mm
Shaft Diameter Schaftdurchmesser	∅ 3,0 mm	∅ 3,0 mm	∅ 3,0 mm	∅ 3,0 mm	∅ 3,0 mm	∅ 3,0 mm
Item No. Artikelnummer	TOZ-0	TOZ-0L	TOZ-1	TOZ-1L	TOZ-2	TOZ-2L

	 90° 1/1	 120° 1/1			
	VASCULAR GEFÄSS				
Total Length Gesamtlänge	290 mm	320 mm	290 mm	320 mm	
Shaft Diameter Schaftdurchmesser	∅ 3,0 mm	∅ 3,0 mm	∅ 3,0 mm	∅ 3,0 mm	
Item No. Artikelnummer	TOZ-3	TOZ-3L	TOZ-4	TOZ-4L	

	 25° 1/1 DELICATE/FEIN	 45° 1/1 DELICATE/FEIN	 60° 1/1 DELICATE/FEIN	 90° 1/1 DELICATE/FEIN	 120° 1/1 DELICATE/FEIN
	VASCULAR GEFÄSS				
Total Length Gesamtlänge	290 mm	290 mm	290 mm	290 mm	290 mm
Shaft Diameter Schaftdurchmesser	∅ 3,0 mm	∅ 3,0 mm	∅ 3,0 mm	∅ 3,0 mm	∅ 3,0 mm
Item No. Artikelnummer	TPA-1	TPA-2	TPA-3	TPA-4	TPA-5



CERAMO® HCR

MICS INSTRUMENTS  
MICS INSTRUMENTE



	 <p>5 x 30 mm</p>	
	<p>NON-TRAUMATIC GRASPING FORCEPS ATRAUMATISCHE ORGANFASSZANGE</p>	
Total Length Gesamtlänge	370 mm	450 mm
Shaft Diameter Schaftdurchmesser	Ø 5,0 mm	Ø 5,0 mm
Item No. Artikelnummer	MRL-8	MRL-8L

	 <p>25° 1/4</p>				
	<p>KNOT PUSHER</p>				
Total Length Gesamtlänge	280 mm	340 mm	400 mm	280 mm	350 mm
Shaft Diameter Schaftdurchmesser	Ø 5,0 mm	Ø 5,0 mm	Ø 5,0 mm	Ø 3,0 mm	Ø 3,0 mm
Item No. Artikelnummer	MRQ-2	MRB-6 MRB-6B <sup>1)</sup>	MRB-6L	MSQ-2	MSQ-1

1) WITH LOOK / MIT SPERRE

	 <p>1/4</p>		
	<p>KNOT PUSHER KNOTENSCHIEBER</p>		
Total Length Gesamtlänge	280 mm	350 mm	400 mm
Shaft Diameter Schaftdurchmesser	Ø 3,4 mm	Ø 3,4 mm	Ø 3,4 mm
Item No. Artikelnummer	MQY-5K	MQY-5	MQY-5L

CERAMO® HCR

MICS INSTRUMENTS  
MICS INSTRUMENTE



				
	<b>CLIP APPLYER <sup>1)</sup></b> <b>CLIPANLEGEZANGE</b>			
Total Length Gesamtlänge	370 mm	370 mm	365 mm	375 mm
	SMALL	MEDIUM	MEDIUM	MEDIUM
Shaft Diameter Schaftdurchmesser	Ø 5,0 mm	Ø 5,0 mm	Ø 5,0 mm	Ø 5,0 mm
Item No. Artikelnummer	MRG-3T	MRG-4T	MRG-4 <sup>2)</sup> MSO-0 <sup>1)</sup>	MRG-4C <sup>2)</sup>

1) FOR/FÜR ETHICON + HORIZON CLIPS  
2) WITH CERAMO® / MIT CERAMO®

CERAMO® HCR

MICS INSTRUMENTS  
MICS INSTRUMENTE



	 $\frac{1}{4}$ 1 x / mm	
	NERV HOOK NERVHAKEN	
Total Length Gesamtlänge	280 mm	340 mm
Shaft Diameter Schaftdurchmesser	Ø 4,5 mm	Ø 4,5 mm
Item No. Artikelnummer	MRQ-1	MRB-4

	 $\frac{1}{4}$
	SCALPEL HANDLE <sup>1)</sup> SKALPELLGRIFF
Total Length Gesamtlänge	350 mm
Shaft Diameter Schaftdurchmesser	Ø 5,0 mm
Item No. Artikelnummer	MRL-4

	 $\frac{1}{4}$ 10 mm
	VALVE INSPECTOR KLAPPENFÜHRINSTR.
Total Length Gesamtlänge	350 mm
Shaft Diameter Schaftdurchmesser	Ø 3,0 mm
Item No. Artikelnummer	MRL-2

1) FOR BEAVER BLADES / FÜR BEAVER MESSER

$\frac{2}{3}$

CERAMO® HCR

MICS INSTRUMENTS  
MICS INSTRUMENTE



		
	MAGNETIC FINDER MAGNETSTAB	
Total Length Gesamtlänge	350 mm	
Shaft Diameter Schaftdurchmesser	Ø 5,0 mm	
Item No. Artikelnummer	MRL-5	

		
	KNOT PUSHER KNOTENSCHIEBER	
Total Length Gesamtlänge	280 mm	340 mm
Shaft Diameter Schaftdurchmesser	Ø 5,0 mm	Ø 5,0 mm
Item No. Artikelnummer	MRK-9K	MRK-9P

TREEDE MAXPOSITION BLADE (SIZE ADJUSTABLE)  
TREEDE MAXPOSITION BLATT (GRÖSSENVERSTELLBAR)

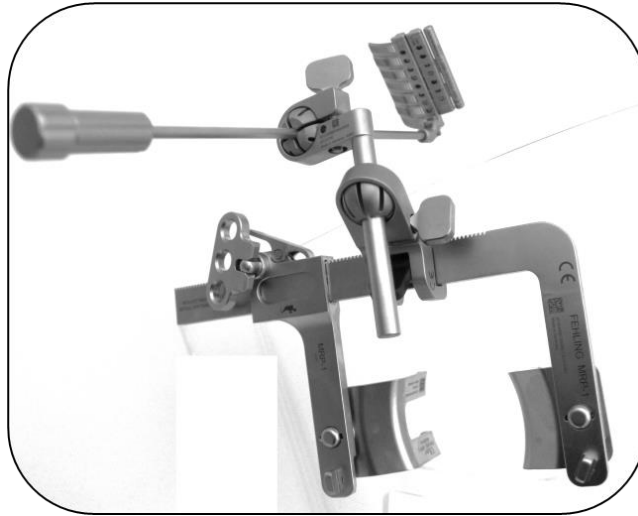

exemplary configuration  
Beispielkonfiguration



2/3

U.S. Pat. 11,806,003

	LENGTH x WIDTH LÄNGE x BREITE	SPREADING WIDTH SPREIZWEITE
MMZ-8	46 x 30 mm	D 40
MMZ-7	46 x 40 mm	D 60



cardian screw driver Torx LMT-4T required  
Kardianschraubendreher Torx LMT-4T erforderlich



BLADE GUIDE  
HAKENFÜHRUNG  
MRN-3

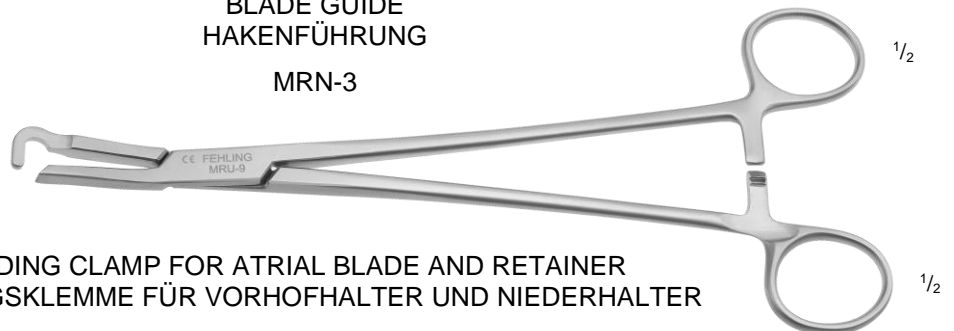

GUIDING CLAMP FOR ATRIAL BLADE AND RETAINER  
FÜHRUNGSKLEMME FÜR VORHOFHALTER UND NIEDERHALTER

MRU-9

SUPERFLEX SOFT TISSUE RETRACTOR  
WEICHGEWEBERETRAKTOR

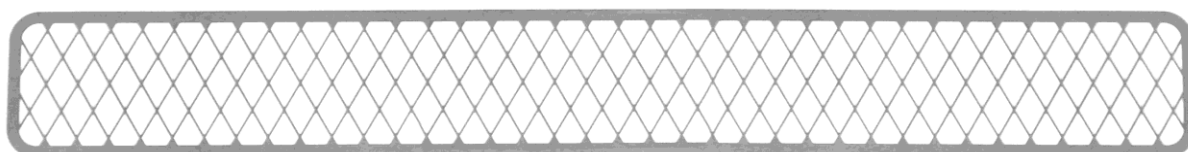

2/3

THICKNESS STÄRKE	25 x 200 mm	30 x 300 mm
0,13 mm	MTI-0	
0,17 mm		MTK-4
0,22 mm		MTK-5
0,25 mm	MTK-1	
0,34 mm	MTK-2	MTK-6
0,45 mm	MTK-3	



STERILISATION AND STORAGE TRAY FOR MTI-0  
STERILISIER- UND LAGERSIEB FÜR MTI-0  
220 x 51,2 x 19,5 mm

MTK-0



SOMOHA

RETRACTOR  
SPREIZER



SPREADING WIDTH SPREIZWEITE	LENGTH LÄNGE	ITEM NO. ARTIKELNUMMER
D 19-21 mm	87 mm	MTJ-1
D 21-23 mm	93 mm	MTJ-2
D 23-25 mm	100 mm	MTJ-3