



CERAMO® HCR

MICS INSTRUMENTS
MICS INSTRUMENTE

FORCEPS / PINZETTEN



	 1,2 x 8 mm		 1 x 10 mm		 3 x 15 mm		
	SUTURE NAHT				VALVE KLAPPE		
Total Length Gesamtlänge	280 mm	350 mm	345 mm	400 mm	280 mm	350 mm	400 mm
Shaft Diameter Schaftdurchmesser	∅ 3,5 mm	∅ 3,4 mm	∅ 5,0 mm	∅ 5,0 mm	∅ 5,0 mm	∅ 5,0 mm	∅ 5,0 mm
Item No. Artikelnummer	MRC-1	MSP-7	MRA-5	MRA-5L	MQZ-8	MRA-0 MRQ-3 ¹⁾ MQZ-9 ²⁾	MRA-0L MRQ-3L ¹⁾ MQZ-9L ²⁾

	 1/4			 1/4 Disc/Teller 1 mm
	RUSSIAN RUSSISCH			TISSUE GEWEBE
Total Length Gesamtlänge	280 mm	350 mm	400 mm	350 mm
Shaft Diameter Schaftdurchmesser	∅ 5,0 mm	∅ 5,0 mm	∅ 5,0 mm	∅ 3,0 mm
Item No. Artikelnummer	MQZ-5	MRQ-5	MRQ-5L	MSQ-4

1) WITH LOOK / MIT SPERRE
2) DE BAKEY-TOOTHING / DE BAKEY-ZAHNUNG

CERAMO® HCR

MICS INSTRUMENTS
MICS INSTRUMENTE

FORCEPS / PINZETTEN



	<p>45° ¼ 1,5 x 11 mm</p>		<p>¼ 1,5 x 11 mm</p>		
	NON-TRAUMATIC ATRAUMATISCH				
Total Length Gesamtlänge	350 mm	400 mm	280 mm	350 mm	400 mm
Shaft Diameter Schaftdurchmesser	Ø 5,0 mm	Ø 5,0 mm	Ø 5,0 mm	Ø 5,0 mm	Ø 5,0 mm
Item No. Artikelnummer	MRG-7	MRG-7L	MSO-6	MRG-6	MRG-6L



	<p>¼ 2,8 x 15 mm</p>				<p>45° ¼ 2,8 x 15 mm</p>			
	NON-TRAUMATIC ATRAUMATISCH							
Total Length Gesamtlänge	290 mm	350 mm	280 mm	350 mm	400 mm	350 mm	400 mm	
Shaft Diameter Schaftdurchmesser	Ø 3,0 mm	Ø 3,0 mm	Ø 5,0 mm	Ø 5,0 mm	Ø 5,0 mm	Ø 5,0 mm	Ø 5,0 mm	
Item No. Artikelnummer	MRC-2D	MSP-8D	MRN-0 MRN-0B ¹⁾	MRA-3 MRA-3B ¹⁾ MRA-3U ²⁾	MQZ-2 ¹⁾ MRA-3L	MRA-4	MRA-4L	



1) WITH LOCK / MIT SPERRE
2) NO CERAMO / KEIN CERAMO*

CERAMO® HCR

MICS INSTRUMENTS
MICS INSTRUMENTE

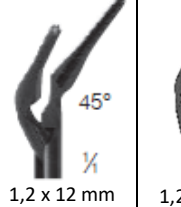
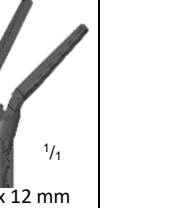
FORCEPS / PINZETTEN

	 1,2 x 15 mm $\frac{1}{4}$	 1,4 x 12 mm $\frac{1}{4}$ 45°	 1,2 x 12 mm $\frac{1}{4}$ 45°	 1,2 x 12 mm $\frac{1}{4}$	
	NON-TRAUMATIC ATRAUMATISCH				
Total Length Gesamtlänge	240 mm	290 mm	280 mm	280 mm	350 mm
Shaft Diameter Schaftdurchmesser	Ø 3,4 mm	Ø 3,5 mm	Ø 3,5 mm	Ø 3,5 mm	Ø 3,4 mm
Item No. Artikelnummer	MRC-2K	MRC-2	MRC-0	MRC-3	MSP-9

	 $\frac{1}{4}$ DELICATE / FEIN	 $\frac{1}{4}$ DELICATE / FEIN	 $\frac{1}{4}$ 2,8 x 15 mm
	NON-TRAUMATIC ATRAUMATISCH		
Total Length Gesamtlänge	350 mm	350 mm	400 mm
Shaft Diameter Schaftdurchmesser	Ø 3,0 mm	Ø 3,0 mm	Ø 3,4 mm
Item No. Artikelnummer	MSP-9D	MSQ-3	MRB-7



2/3





CERAMO® HCR

MICS INSTRUMENTS
MICS INSTRUMENTE

NEEDLE HOLDERS / NADELHALTER (WITH LOOK / MIT SPERRE)



	 1 x 10 mm max. 6x0				 2 x 10 mm max. 5x0		
	TCM						
Total Length Gesamtlänge	250 mm	280 mm	350 mm	350 mm	240 mm	280 mm	360 mm
Shaft Diameter Schaftdurchmesser	Ø 3,5 mm	Ø 3,4 mm	Ø 5,0 mm	Ø 3,4 mm	Ø 3,5 mm	Ø 3,5 mm	Ø 3,5 mm
Item No. Artikelnummer	MRM-4	MRC-5	MSO-1	MSP-6	MRC-4K	MRC-4	MRC-4L

	 1,5 mm max. 5x0	 1 x 10 mm max. 5x0	 2 x 10 mm max. 5x0	 3 x 10 mm max. 3x0		
	TC RYDER	TCM				
Total Length Gesamtlänge	350 mm	340 mm	340 mm	280 mm	340 mm	430 mm
Shaft Diameter Schaftdurchmesser	Ø 5,0 mm	Ø 5,0 mm	Ø 5,0 mm	Ø 5,0 mm	Ø 5,0 mm	Ø 5,0 mm
Item No. Artikelnummer		MRB-3	MRB-2	MRG-8	MRB-1 MRB-1U ¹⁾	MRD-5

1) WITHOUT LOOK / OHNE SPERRE

CERAMO® HCR

MICS INSTRUMENTS
MICS INSTRUMENTE

NEEDLE HOLDERS / NADELHALTER (WITH LOOK / MIT SPERRE)



	<p>2,5 x 10 mm <i>max. 2x0</i></p>		<p>3 x 10 mm <i>max. 2x0</i></p>	
	TC			
Total Length Gesamtlänge	340 mm	280 mm	340 mm	400 mm
Shaft Diameter Schaftdurchmesser	Ø 5,0 mm	Ø 5,0 mm	Ø 5,0 mm	Ø 5,0 mm
Item No. Artikelnummer	MRT-1	MRT-6	MRG-9 MRD-0 ¹⁾	MRG-9L

	<p>3 x 10 mm <i>max. 2x0</i></p>			
	TC			
Total Length Gesamtlänge	280 mm	340 mm	350 mm	440 mm
Shaft Diameter Schaftdurchmesser	Ø 5,0 mm	Ø 5,0 mm	Ø 5,0 mm	Ø 5,0 mm
Item No. Artikelnummer	MSO-5	MRG-2S MRB-9 ¹⁾	MRG-2	MRG-2L ¹⁾



1) WITHOUT LOOK / OHNE SPERRE



CERAMO® HCR

MICS INSTRUMENTS
MICS INSTRUMENTE

SCISSORS / SCHEREN



							
	VALVE KLAPPE						
Total Length Gesamtlänge	280 mm	350 mm	280 mm	350 mm	280 mm	350 mm	450 mm
Shaft Diameter Schaftdurchmesser	Ø 5,0 mm	Ø 5,0 mm	Ø 5,0 mm	Ø 5,0 mm	Ø 5,0 mm	Ø 5,0 mm	Ø 5,0 mm
Item No. Artikelnummer	MQZ-7	MRT-2	MSO-2	MRT-3	MSO-3	MRD-7	MRD-7L



						
	VALVE KLAPPE					
Total Length Gesamtlänge	350 mm	280 mm	350 mm	280 mm	350 mm	
Shaft Diameter Schaftdurchmesser	Ø 5,0 mm	Ø 5,0 mm	Ø 5,0 mm	Ø 5,0 mm	Ø 5,0 mm	
Item No. Artikelnummer	MRA-7	MSO-4	MRT-5	MQZ-6	MSO-8	







2/3

CERAMO® HCR

MICS INSTRUMENTS
MICS INSTRUMENTE

SCISSORS / SCHEREN

							
	DISSECTION PRÄPARATION			MICRO DISSECTION MIKRO PRÄPARATION			
Total Length Gesamtlänge	280 mm	350 mm	430 mm	280 mm	350 mm	280 mm	350 mm
Shaft Diameter Schaftdurchmesser	Ø 5,0 mm	Ø 5,0 mm	Ø 5,0 mm	Ø 3,4 mm	Ø 3,4 mm	Ø 3,5 mm	Ø 3,4 mm
Item No. Artikelnummer	MRQ-0	MRA-6	MRD-6	MSP-1D	MRC-6D	MRC-6	MSP-1

						
	VASCULAR GEFÄSS					
Total Length Gesamtlänge	280 mm	280 mm	280 mm	335 mm	345 mm	345 mm
Shaft Diameter Schaftdurchmesser	Ø 3,5 mm	Ø 3,5 mm	Ø 3,5 mm	Ø 5,0 mm	Ø 5,0 mm	Ø 5,0 mm
Item No. Artikelnummer	MRC-7	MRC-8	MRM-0	MRA-9	MRA-8B	MRA-8







CERAMO® HCR

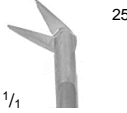

MICS INSTRUMENTS
MICS INSTRUMENTE

SCISSORS / SCHEREN



	 25° 1/1		 45° 1/1		 60° 1/1	
	VASCULAR GEFÄSS					
Total Length Gesamtlänge	290 mm	320 mm	290 mm	320 mm	290 mm	320 mm
Shaft Diameter Schaftdurchmesser	∅ 3,0 mm	∅ 3,0 mm	∅ 3,0 mm	∅ 3,0 mm	∅ 3,0 mm	∅ 3,0 mm
Item No. Artikelnummer	TOZ-1	TOZ-1L	TOZ-0	TOZ-0L	TOZ-2	TOZ-2L

	 90° 1/1		 120° 1/1	
	VASCULAR GEFÄSS			
Total Length Gesamtlänge	290 mm	320 mm	290 mm	320 mm
Shaft Diameter Schaftdurchmesser	∅ 3,0 mm	∅ 3,0 mm	∅ 3,0 mm	∅ 3,0 mm
Item No. Artikelnummer	TOZ-3	TOZ-3L	TOZ-4	TOZ-4L

	 25° 1/1 DELICATE/FEIN	 60° 1/1 DELICATE/FEIN	 120° 1/1 DELICATE/FEIN
	VASCULAR GEFÄSS		
Total Length Gesamtlänge	290 mm	290 mm	290 mm
Shaft Diameter Schaftdurchmesser	∅ 3,0 mm	∅ 3,0 mm	∅ 3,0 mm
Item No. Artikelnummer	TPA-1	TPA-3	TPA-5

CERAMO® HCR

MICS INSTRUMENTS
MICS INSTRUMENTE



	 <p>5 x 30 mm</p>
	<p>NON-TRAUMATIC GRASPING FORCEPS ATRAUMATISCHE ORGANFASSZANGE</p>
Total Length Gesamtlänge	370 mm
Shaft Diameter Schaftdurchmesser	Ø 5,0 mm
Item No. Artikelnummer	MRL-8 MRL-8L ¹⁾

				
	<p>KNOT PUSHER KNOTENSCHIEBER</p>			
Total Length Gesamtlänge	280 mm	340 mm	280 mm	350 mm
Shaft Diameter Schaftdurchmesser	Ø 5,0 mm	Ø 5,0 mm	Ø 3,0 mm	Ø 3,0 mm
Item No. Artikelnummer	MRQ-2	MRB-6 MRB-6B ¹⁾	MSQ-2	MSQ-1

1) WITH LOCK / MIT SPERRE

CERAMO® HCR

MICS INSTRUMENTS
MICS INSTRUMENTE



				
	CLIP APPLIER ¹⁾ CLIPANLEGEZANGE			
Total Length Gesamtlänge	370 mm	370 mm	365 mm	375 mm
	SMALL	MEDIUM	MEDIUM	MEDIUM
Shaft Diameter Schaftdurchmesser	Ø 5,0 mm	Ø 5,0 mm	Ø 5,0 mm	Ø 5,0 mm
Item No. Artikelnummer	MRG-3T	MRG-4T	MRG-4 ²⁾	MRG-4C ²⁾

1) FOR/FÜR ETHICON + HORIZON CLIPS
2) WITH CERAMO® / MIT CERAMO®

CERAMO® HCR

MICS INSTRUMENTS
MICS INSTRUMENTE



	 1 x / mm	
	NERV HOOK NERVHAKEN	
Total Length Gesamtlänge	280 mm	340 mm
Shaft Diameter Schaftdurchmesser	Ø 4,5 mm	Ø 4,5 mm
Item No. Artikelnummer	MRQ-1	MRB-4

	 1/4
	SCALPEL HANDLE ¹⁾ SKALPELLGRIFF
Total Length Gesamtlänge	350 mm
Shaft Diameter Schaftdurchmesser	Ø 5,0 mm
Item No. Artikelnummer	MRL-4

	 10 mm
	VALVE INSPECTOR KLAPPENFÜHRINSTR.
Total Length Gesamtlänge	350 mm
Shaft Diameter Schaftdurchmesser	Ø 3,0 mm
Item No. Artikelnummer	MRL-2

1) FOR BEAVER BLADES / FÜR BEAVER MESSER

2/3

CERAMO® HCR

MICS INSTRUMENTS
MICS INSTRUMENTE



		
	MAGNETIC FINDER MAGNETSTAB	
Total Length Gesamtlänge	350 mm	
Shaft Diameter Schaftdurchmesser	Ø 5,0 mm	
Item No. Artikelnummer	MRL-5	

		
	KNOT PUSHER KNOTENSCHIEBER	
Total Length Gesamtlänge	280 mm	340 mm
Shaft Diameter Schaftdurchmesser	Ø 5,0 mm	Ø 5,0 mm
Item No. Artikelnummer	MRK-9K	MRK-9P