



Accutinter 8000*Elite* | End User Guide

Getting Started

Maintenance and Care

Troubleshooting

Warranty

Part No: 35616
Rev. D
04.2016



Your

customers have a vision,
you want to make it happen, and

Fluid Management can give you the answer.

Fluid Management is a global leader in dispensing and mixing equipment used in the paint industry, as well as, specialized equipment for the chemical, and home improvement industries.

Located in the suburbs of Chicago, Illinois, Fluid Management is a United States owned and operated company with historical roots to the paint industry dating back to 1927. In 1996, IDEX Corporation purchased Fluid Management giving the organization the financial wherewithal and global footprint of a large organization while still maintaining its deep values and history.

As industry leaders, Fluid Management provides trend-setting creativity in the design, products, and services it offers. United with FMDirectSM, our nationwide service team, we provide after-sales support around the clock—when you need them. Being factory-direct employees, FMDirect technicians are experts on Fluid Management equipment and understand customer needs from start to finish.

The combination of leading edge technology, excellent service and support, and a company prepared for the future's ever-changing business environment makes Fluid Management an ideal partner to assist in providing solutions to your business needs. Thank you for putting your trust in Fluid Management products and making us part of your customer's vision.

©2012 Fluid Management as published work all rights reserved.

Under the copyright laws, this material may not be copied, in whole or in part, without the written consent of Fluid Management.

Your rights to the software are governed by the accompanying software license agreement.

Use of Fluid Management trademarks, service marks, or logos for commercial purposes without the prior written consent of Fluid Management may constitute trademark infringement and unfair competition in violation of federal and state laws. Fluid Management, FMDirect, ColorPro, DVX, Harbil, Blendorama, Accutinter, Duraflow, Fast & Fluid Management, GyroFlex, GyroMixer, Infina, MicroTint, TintMaster, V1, and VR1 are trademarks of Fluid Management, registered in the U.S. and/or other countries.



Every effort has been made to ensure that the information in this guide is accurate. Fluid Management is not responsible for printing or clerical errors.

Fluid Management

1023 Wheeling Road
Wheeling, Illinois 60090-5776 USA
800-462-2466
<http://www.fluidman.com>

Published in the United States.

Mention of third-party products is for informational purposes only and constitutes neither an endorsement nor a recommendation. Fluid Management assumes no responsibility with regard to the performance or use of these products.



Fluid Management Accutinter 8000Elite

Once you've installed your Accutinter 8000Elite Dispenser, what's next? In this booklet, you'll find more information to help you get the most from your new Fluid Management Accutinter 8000Elite.



ACCUTINTER 8000ELITE



Contents

About this Guide

- 5 How to Use this Guide
- 5 For Your Safety

Important Safety Information

- 6 Information and Instruction Labels
- 6 Safety Notice Information
- 6 General Safety Information
- 6 Air Circulation
- 7 Grounding
- 7 Danger
- 7 Caring for Your Computer
- 7 Communication Regulation Information

Getting to Know Your Accutinter 8000*Elite*

- 8 Technical Specifications
- 8 Environmental Conditions
- 8 Optional Accessories
- 9 Accutinter 8000*Elite* Features
- 9 Tips to Improve Operation

Getting Started

- 10 Installation
- 11 Unpacking and Set Up
- 13 Connecting the label printer (optional)
- 14 Connecting the barcode scanner (optional)
- 16 Preparing and refilling the canisters
- 18 Preparing the system
- 19 Using the shelves

Basic Operations

- 20 Welcome to ColorPro4
- 21 Main menu
- 22 Dispensing from Formula Book
- 24 Manual dispensing
- 25 Using external data source and dispense queuing
- 26 Adjusting formulas
- 27 Using color scaling
- 28 Purging the lines
- 29 Stirring the colorants
- 30 Using ColorPro Help

Maintenance, Care and Use

- 31 Daily, weekly, monthly maintenance

Frequently Asked Questions

- 32 Equipment troubleshooting
- 36 ColorPro troubleshooting

Service

- 38 FMDirect
- 38 Upgrades and Replacement Parts
- 38 Obtain Warranty Service

Warranty

- 39 Fluid Management Statement of Limited Warranty

Index

- 42 A - W



About this Guide

How to Use this Guide

This *Guide* is organized into nine sections. Each section provides detailed information on Accutinter 8000*Elite* topics and provides a basic reference that can be used to help you with specific issues.

This *Guide* provides the information for installing your Accutinter 8000*Elite*, dispensing for the first time, and using ColorPro. This publication also includes basic troubleshooting suggestions, customer service help, information, daily and preventative maintenance procedures, and warranty information.

Your Accutinter 8000*Elite* dispenser includes detailed illustrated labels for how to clean the nozzles located inside the top canister cover of the machine. You can also find daily maintenance instructions in this guide on page 31. Make sure to follow these directions for the best performance of your machine.

ColorPro has basic information about using your Accutinter in the **Help** section of the software.

If you have internet access, the most current information for your Accutinter 8000*Elite* is available from the worldwide web at <http://www.fluidman.com>.

For Your Safety

Customer safety is important. Our products are designed to be safe and effective. However, dispensers are electrical equipment. The Accutinter line is safe, fast, and reliable—designed to bring many years of operation. There are precautions you can take to avoid damage to the equipment or bodily injury before operating. By carefully following the instructions in this document and the warning and maintenance labels on the machine, you can help protect yourself from hazards and create a safer work environment.

Equipment can become damaged due to misuse or neglect. Some product damage is serious enough that the product should not be used again until it has been inspected and, if necessary, repaired by a Fluid Management authorized service technician. **DO NOT** take risks or attempt to diagnose the situation yourself. Contact Fluid Management at 1.800.462.2466 for assistance.

NOTE: *This appliance can be used by children aged from 8 years and above, and persons with reduced physical, sensory, or mental capabilities or lack of experience and knowledge, if they have been given supervision or instruction concerning use of the appliance in a safe way and understand the hazards involved. Children shall not play with the appliance. Cleaning and user maintenance shall not be made by children without supervision.*

Safety Precautions

- Read this guide and all warning labels before using the machine.
- Keep this guide in a safe place.
- Read and adhere to all Warning and Caution labels on the machine.
- Prepare, level, and clear the area where the machine will be installed.
- To avoid risk of fire or injury, unplug the power before servicing electrical components.
- DO NOT dispense flammable materials.
- After installing, complete a purge and check the plumbing.
- Check that canisters and lines are secure and in place.
- Plug into an approved grounded outlet only. Make sure the outlet meets all national and local codes.
- DO NOT install equipment in an area that water jet equipment is used.
- DO NOT push any objects into the air vents or openings of your equipment. Doing so can cause fire or electric shock by shorting out interior components.
- DO NOT • Ensure that nothing rests on your equipment's cables and that the cables are not located where they can be stepped on or tripped over.



Important Safety Information



WARNING:
**Unplug before
servicing**

Information and Instruction Labels

You should become familiar with the information labels affixed to the machine, as well as the warnings, cautions, and notes which appear throughout this guide. Read all the warning labels on the exterior and interior of the dispenser. If the labels become damaged or unreadable, you may purchase replacements from Fluid Management Customer Service.



**Use a dedicated
15 amp circuit**

Safety Notice Information

• **WARNING**
**HAZARDOUS
ELECTRICAL
COMPONENTS**

The two main notices used in this *Guide* and on the Accutinter 8000*Elite* are **Warning** and **Caution**. A **Warning** notice tells you about a hazard that could cause serious injury to you or extensive damage to the equipment. This information is featured in the beginning of the guide to emphasize safety.

When you see a **Warning** notice in this guide, read it carefully before continuing with the operation of the machine. Take all necessary precautions to avoid potential injury.



WARNING:
**DO NOT use with or
near flammables**

• **CAUTION:**
**POTENTIAL
SAFETY
HAZARD**

A **Caution** notice tells you about a danger that could cause injury to you or minor damage to the dispenser. When you see a **Caution** notice in this guide, read it carefully and be sure you understand it before continuing.

General Safety Information

DO NOT attempt to service a product yourself unless instructed to do so by Fluid Management Customer Service. Use only a Fluid Management Authorized Service Technician to repair your equipment. Please note that some parts can be upgraded or replaced by the customer. Fluid Management identifies those parts as such and provides documentation with instructions when it is appropriate for customers to replace those parts. You must closely follow all instructions when performing such replacements. **ALWAYS** make sure that the power is turned off and that the machine is unplugged before you attempt the replacement. If you have any questions or concerns, contact Fluid Management Customer Service.

Air Circulation

Your computer and monitor for your dispenser produce heat. The computer has a fan that pulls in fresh air and forces out hot air. The monitor lets hot air escape through vents. Blocking the air vents can cause overheating, which might result in a malfunction or damage. Place the computer and monitor so that nothing blocks the air vents. Allow 4 inches (101.6 mm) clearance around air vents.



Important Safety Information

Grounding

This product must be grounded. In the event of an electrical short circuit, grounding reduces the risk of electrical shock by providing an escape for the electric current. This product is equipped with a cord that has a grounding wire and an appropriate grounding plug. The plug must be inserted into an outlet that is properly installed and grounded in accordance with all local codes and ordinances.

Danger

Improper installation of the grounding plug can result in a risk of electric shock. If repair or replacement of the cord or plug is necessary, **DO NOT** connect the grounding wire to either flat blade terminal. The insulation wire with green or green and yellow stripes on the outer surface is the grounding wire. Check with a qualified electrician if the grounding instructions are not completely understood, or if in doubt about whether the product is properly grounded. **DO NOT modify the plug provided.** If it will not fit into the outlet, have the proper outlet installed by a qualified electrician.

NOTE: This product is for use on a dedicated nominal 120 Volt (US only) or nominal 220 volt circuit where applicable and has a grounding plug.

Caring for Your Computer

Disconnect the power plug on the computer (by pulling the plug, not the cord) if any of the following conditions exists:

- You want to remove any parts.
- The power cord or plug becomes frayed or otherwise damaged.
- You spill something into the case.
- Your computer is exposed to rain, flooding, or any other excess moisture.

Keep the flat panel monitor in room temperature conditions. Excessive cold or hot conditions can have an adverse effect on the liquid crystal display of the monitor.

NOTE: Review the weight limits referenced in your computer documentation before placing monitor or other devices on top of your computer.

Communications Regulation Information

Safety and regulatory compliance Information

See the affixed labeling on the machine. ETL Listed, conforms to UL STD 1450. Certified to CAN/CSA STD C22.2 NO. 68.

FCC Compliance Statement

This device complies with part 15 of the FCC Rules. Operation is subject to the following two conditions: (1) This device may not cause harmful interference, and (2) this device must accept any interference received, including interference that may cause undesired operation.



Fluid Management Customer Service 1.800.462.2466



Warnings

- This machine draws 10 amps at 120 ± 10% VAC.
- This machine draws 5 amps at 220/230 ± 10% VAC.
- DO NOT modify the provided plug.
- Improper use of grounding plug can result in risk of electric shock.
- Hazardous moving parts. Keep fingers and other body parts away.



Cautions

- Check with a qualified electrician or service person if grounding instructions are not completely understood or if in doubt as to whether product is properly grounded.
- DO NOT use an adapter or extension cord with this product.
- This unit must be plugged into a dedicated electrical line.
- To reduce risk of electric shock or injury, use indoors only.
- Never force a connector into a port. If the connector and port do not join with reasonable ease, they probably do not match. Make sure that the connector matches the port and that you have positioned the connector correctly in relation to the port.

Getting to Know Your Accutinter 8000Elite

Technical Specifications

Height: 43" (109 cm)
Width: 45" (114 cm)
Depth 43" (109 cm)
Weight (Empty Canisters):
700 pounds (317 kg)

Maximum power:

- 120 volts +/- 10%, 60 Hz, 10 amp
- 220/230 volts +/- 10%, 50/60 Hz, 5 amp

Environmental Conditions*

- Operating temperature: between 50° F (10° C) and 104° F (40° C)
- Relative humidity: between 5% and 85% without condensation

Optional Accessories

- Computer with 17" Flat Screen Monitor, Keyboard & Mouse
- Label Printer
- Barcode Scanner
- Surge Protector

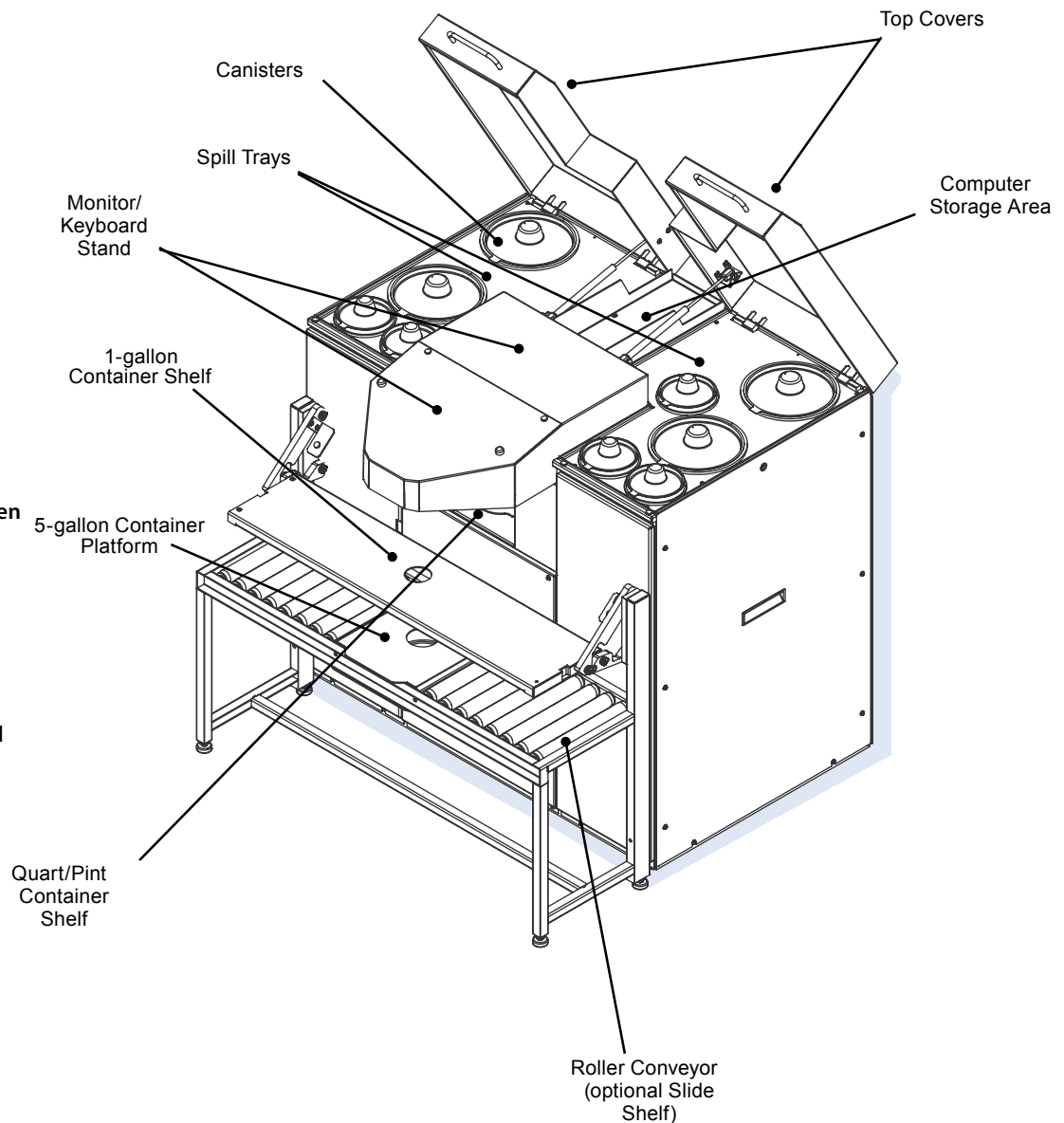

***NOTE:** Environmental conditions are strictly based on the types of colorants used (information provided by paint manufacturer). The specifications shown are for the machine only.



Getting to Know Your Accutinter 8000*Elite*

Accutinter 8000*Elite* Features

- High speed dispense improves your order fulfillment efficiency
- DVX technology reduces frequency of calibration maintenance, parts and costs while providing amazing accuracy, reliability, and repeatability with each dispense
- Precision tinting-order after order
- Compact footprint-small design with large capacity
- Robust conveyor front for queuing 5-gallon containers with drop down 1-gallon shelf and pull out quart/pint shelf.
- Automatic nozzle closer and sealed canister lids provide improved environment for waterborne colorants
- Automatic and manual agitation settings keep colorant viscosity ready for use
- LED locators including 5-gallon bung hole locator for improved container alignment
- Stainless steel surfaces for easy cleaning
- Swing out electronics door and casters allow for easier service and cleaning access

Tips to Improve Operation

- Clean nozzles daily for consistent and accurate dispense
- Purge each colorant once a day
- Follow the preventative maintenance schedule for your Accutinter 8000*Elite*
- **DO NOT** use solvents in your Accutinter 8000*Elite*
- Keep ColorPro software current
- **DO NOT** load screen savers onto your Accutinter 8000*Elite* computer/monitor. Adding this and other software may conflict with ColorPro and effect dispense operation
- Use the Welcome to ColorPro section of this manual for answers to questions about ColorPro
- Use the correct sized labels for your label printer (optional).



Getting Started

Installation

Your Accutinter 8000*Elite* has been designed for quick set up. If you have never used an Accutinter dispenser or are new to paint dispensers, read this section for instructions on getting started and installing your machine.

If you are an experienced user, you may already know enough to get started. Be sure to look over the information in the “Welcome to ColorPro” section of this guide to find out more about the new features and capabilities in ColorPro.

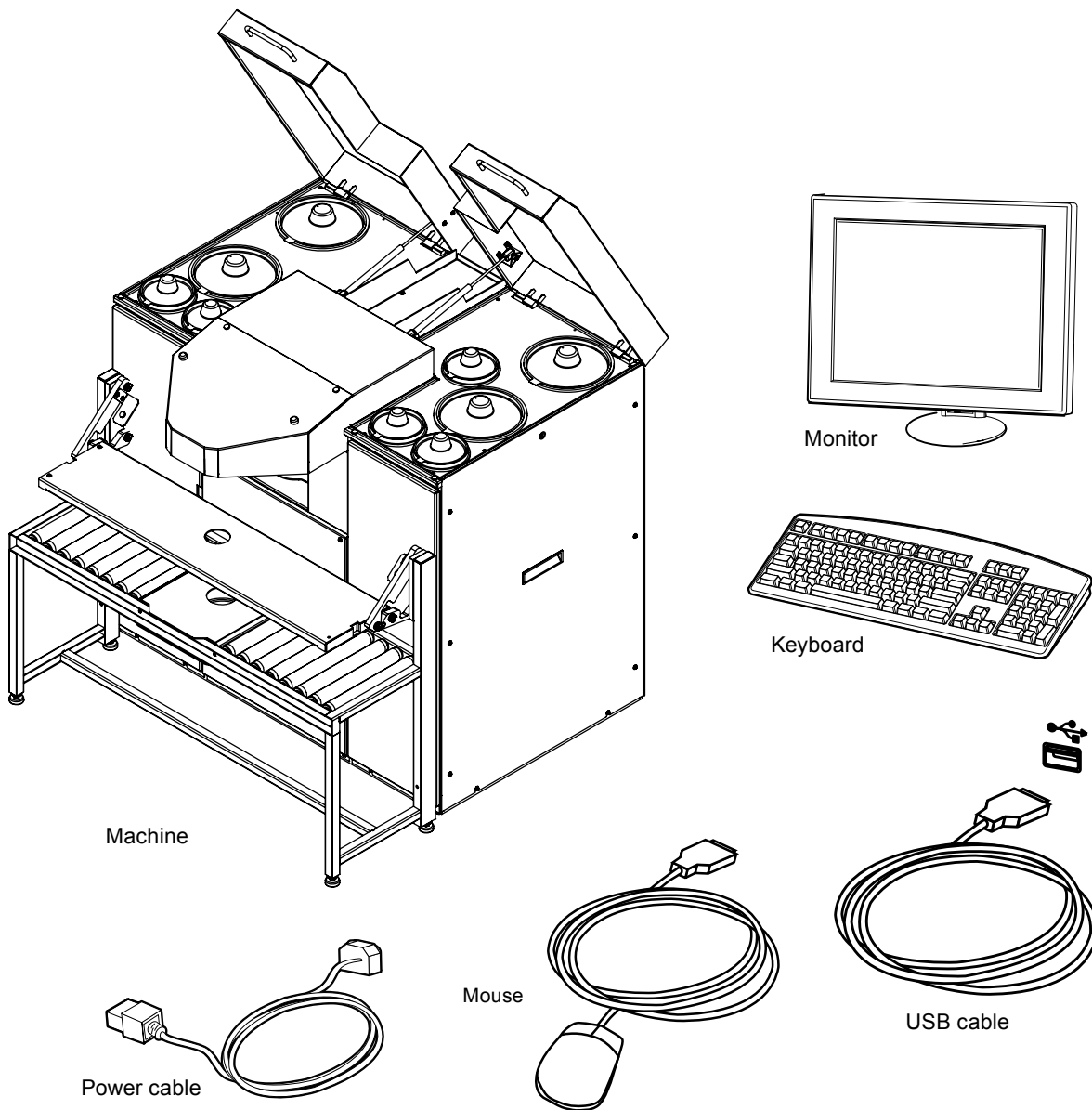

Getting Started

Installation

Unpacking and Set up

Follow the steps on the next four pages to set up your Accutinter 8000Elite.

1 Make sure these items are available before installing.

Accutinter 8000Elite unit
Computer, mouse, and keyboard
Label printer and labels (optional)
Barcode scanner (optional)
Surge protector (not included)

2 Tools needed for installation.

Phillips screwdriver
Scissors or diagonal cutters

3 Unpack the machine.

- Remove the interior contents of the packaging.
- While unpacking the machine, inspect the machine for any damage that may have occurred during shipping.

If any damage is found, notify the carrier immediately. Arrange for inspection in order to claim recovery. Claims for damage must be made by the consignee (YOU). The carrier assumes full responsibility upon acceptance of the shipment and will not entertain any claims by the consignor.

Verify the contents against the packing slip. Note if any items are missing or damaged. Call Fluid Management Customer Service at 1.800.462.2466 if any items are missing.

4 Position dispenser in permanent location.

Choose a location for your dispenser that is capable of supporting the weight (1,000 pounds [454 kg]). Make sure there is enough room for service personnel to have access to the rear of the machine. If there is not enough room, routine maintenance may be difficult to perform.

5 Position the monitor, keyboard, and computer.

Place the monitor and keyboard on the keyboard support on the top of the machine. See Figure 1.

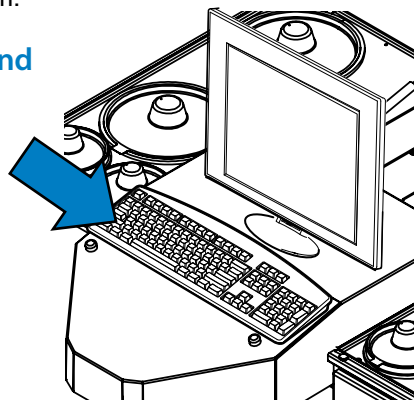

FIGURE 1



• Warnings

ALWAYS shut off the power and unplug your machine from the AC power outlet before servicing.

- This unit must be plugged into a dedicated electrical line. This includes:
 - 15 amp line for 120 Volt equipment
 - 10 amp line for 220 Volt equipment
- The surface the dispenser sits on must be strong enough to support its weight of up to 1,000 lbs (454 kg).
- Dispenser to be installed on surface that is less than 1.5o of tilt to avoid risk of injury
- Replace all fuses with the exact sized replacements.
- This machine is not explosion proof and must not be used in a flammable atmosphere or with flammable materials.
- To reduce the risk of electric shock or injury, use indoors only.



Getting Started

Installation

6 Plug in the power cord and connect all cables.

- Route the keyboard, monitor, and mouse cables to the rear of the machine where the computer has been placed. Plug them into the appropriate ports on the back of the computer.
- If you purchased the optional barcode scanner, label printer or are using a spectrophotometer, route the cables to the rear of the machine where the computer has been placed. Plug these cables into the appropriate ports on the back of the computer.
- Connect the USB cable coming out of the hole of machine where the computer has been placed. Attach the USB cable to the port labeled “DISPENSER” on the back of the computer. *See Figure 2*
- Plug the power cords from the monitor, computer and Accutinter into the recommended surge protector.
- Plug the surge protector into a 15 amp dedicated electrical outlet.

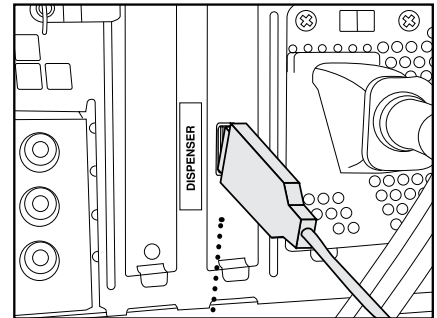
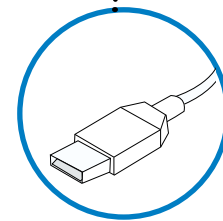

FIGURE 2



7 Turn on machine.

- Locate the front panel below the nozzle closer in the center of the machine.
- Locate and unscrew the two Philips head machine screws provided.
- Open the front panel and locate on the red toggle switch near the bottom of the compartment.
- The red toggle switch needs to be in the ‘ON’ position or ‘RESET’ position for the Accutinter to work properly.
- Close the front panel and screw in the two Philips head machine screws provided.

8 Turn on computer and monitor.

Locate the on/off button on your computer and turn it on. Reference the computer’s user manual if you have difficulty locating.

9 Locate the ColorPro icon on your desktop.

ColorPro and your manufacturer’s database were loaded at Fluid Management’s factory. If you cannot locate the ColorPro icon, Contact Fluid Management Customer Service. Open ColorPro by double clicking on the icon.

10 After the machine is installed fill the canisters and update ColorPro

Complete an initial manual dispense for each colorant.
(See “Getting Started: Preparing and refilling the canisters” on page 16).



Getting Started

Connecting the label printer (optional)

The label printer software for the label printer is installed on the computer by Fluid Management. All you need to do is connect the printer cables to the computer and to a dedicated power outlet. The original packaging from the printer vendor includes the software, a quick start guide with detailed instructions, and the necessary cables.

Follow these steps to connect the printer:

1



- Unpack the printer.
- Make sure you have these items:
 - CD - ROM
 - Quick Start Guide
 - Roll of labels
 - USB cable
 - Label printer
 - Power cable
 - Power adapter
- Plug the power cord into the power adapter.

2



- Plug the power adapter into the power connector on the bottom of the printer.
- Plug the other end of the power cord into a power outlet.
- Plug the USB cable into the bottom of the printer.

3

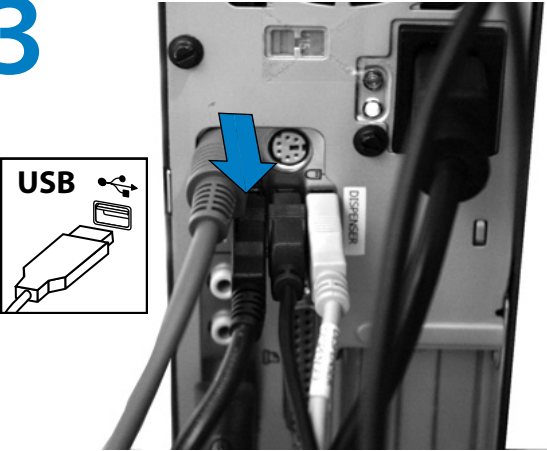

Plug the USB cable into the available USB port on the back of the computer.

4

The blue light on the front of the printer should be on if the printer is ready.

- Click the **Print Label (F5)** button to print labels when dispensing a formula.



Getting Started

Connecting the barcode scanner (optional)

The barcode scanner must be connected to the computer and keyboard. The barcode scanner is pre-programmed by Fluid Management. After the barcode scanner is connected, the scanner must be enabled to be compatible with ColorPro. The original packaging from the vendor includes the barcode scanner, the cable, and a quick start guide.

Follow these steps to install the barcode scanner:

1



- a. Unpack the barcode scanner.
- b. Make sure the barcode scanner and the cable are included.
- c. Turn on the computer.

2

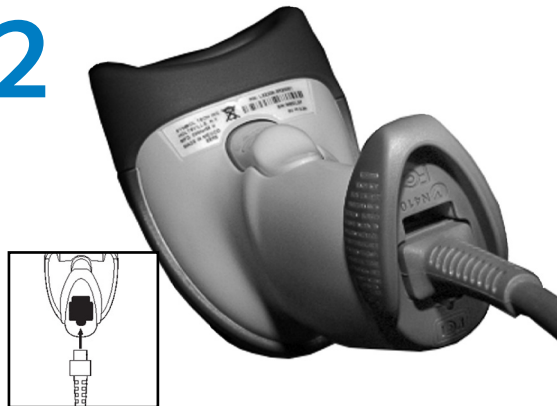

Plug the interface cable modular cord into the port in the bottom of the scanner's handle.

3

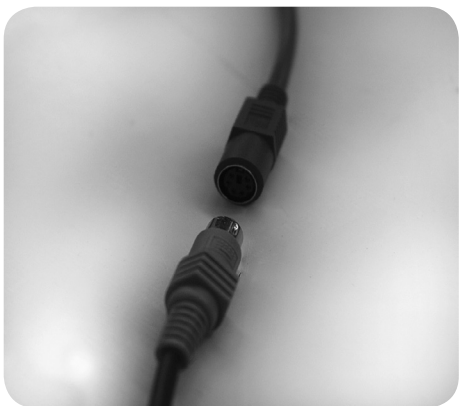

Connect the scanner cable to the keyboard cable from the Accutinter8000Elite.

NOTE! If the keyboard cable is a USB, add an adapter and connect the two cables.

4

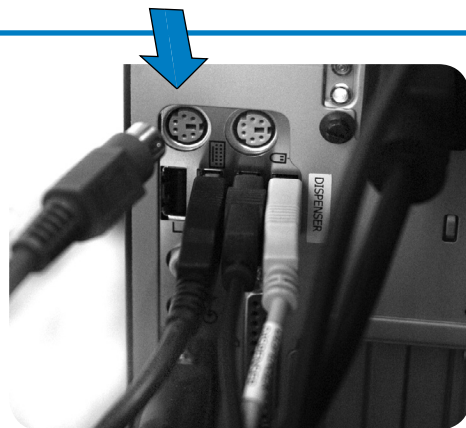

Connect the scanner cable to the purple keyboard connector on the back of the computer where the keyboard symbol is marked.

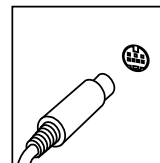

Getting Started

Connecting the barcode scanner (optional)

After the barcode scanner is connected to the computer and keyboard, it must be enabled in ColorPro.

Follow these steps to enable the barcode scanner:

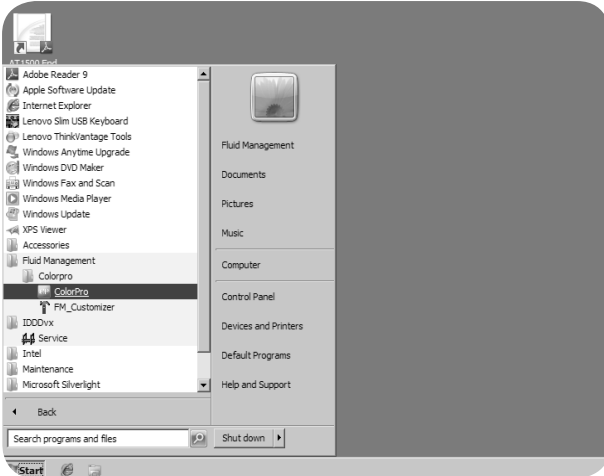

- 5** Locate **FM_Customizer** from Fluid Management folder and launch.
- Type in "service" when you are prompted for the password.
 - Click **Check**.

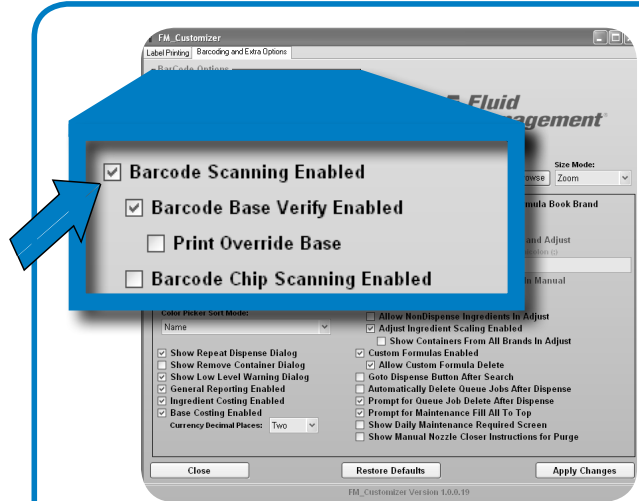

- 6**
- Check the **Barcode Scanning Enabled** box on the **Barcoding and Extra Options** tab.
 - Click **Apply Changes**, then click **Yes** and **OK**.
 - Close.

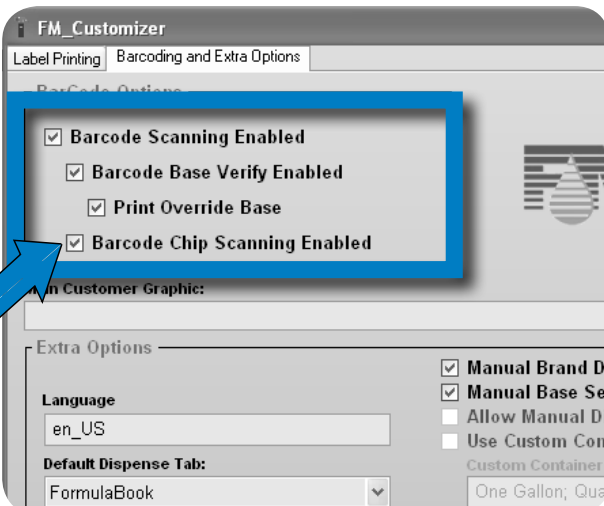

- 7**
- Check **Print Override Base** to allow operators to manually override using scanner.
 - Check **Barcode Chip Scanning Enabled** if you are using barcodes to identify formulas from other color chips.

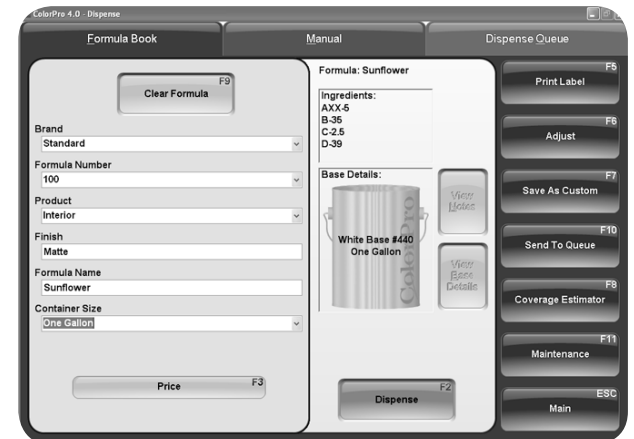

- 8** After enabling the barcode scanner, you can test the scanner by dispensing.
- Open the **Dispense** menu.
 - Select a formula.
 - Click the **Dispense** button. If you receive a prompt that says, "Please Scan the Base Barcode", you have successfully enabled the bar code scanner.



Getting Started

Preparing and refilling the canisters

After your machine is installed in the proper location, you need to fill the canisters with colorant so you can dispense for the first time. Your machine may be shipped with a small amount of glycol or colorant in the canisters already, but you need to fill them to capacity with colorant. When re-filling canisters, you will follow the same process. Canisters come in varying capacities. Check the label inside the top cover for capacity and colorant locations. **DO NOT** overfill the canisters. After the canisters are filled, ColorPro (or your manufacture's software) must be updated (See page 17).

1 Raise the top covers of the Accutinter so you can see the canisters inside.

2 Remove the caps from each canister one at a time and prepare to fill them with colorant.

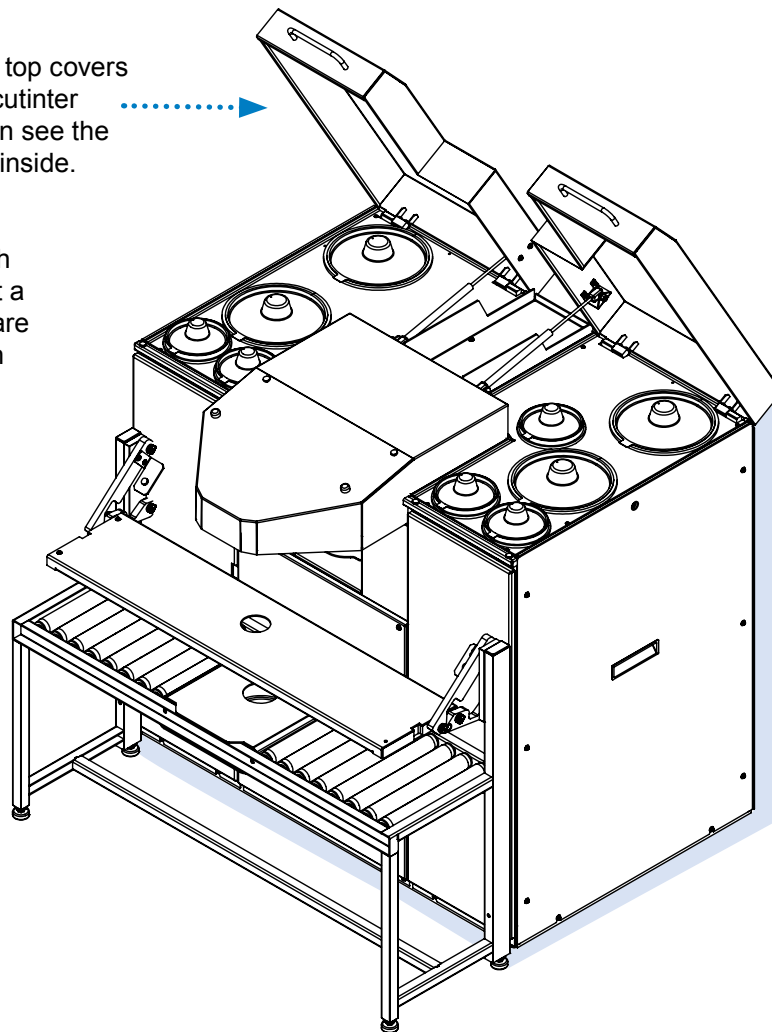

Cautions

- DO NOT operate the dispenser until it is in a permanent location.
- DO NOT dispense if canisters are empty
- Before dispensing colorant for the first time, you must complete a manual dispense.
- DO NOT dispense without a container in place.
- DO NOT use shelf surface to seal open cans.



Getting Started

Preparing and refilling the canisters

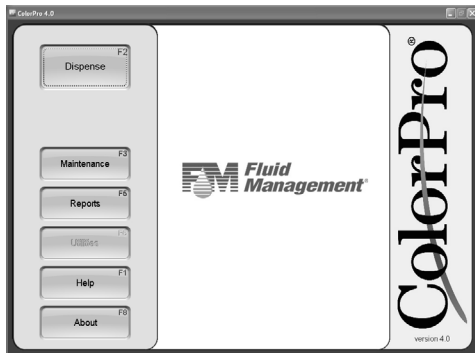

Main Menu

3 Update ColorPro with the canister level information after you have filled all of the canisters.

4 From the Main Menu, select **Maintenance (F3)**. In the **Fill** tab, select **All (F2)**.

Fill Menu ...
Use the Fill Menu to update the software after you have filled all of the canisters for the first time. When refilling, select All (F2) or the correct individual colorant.

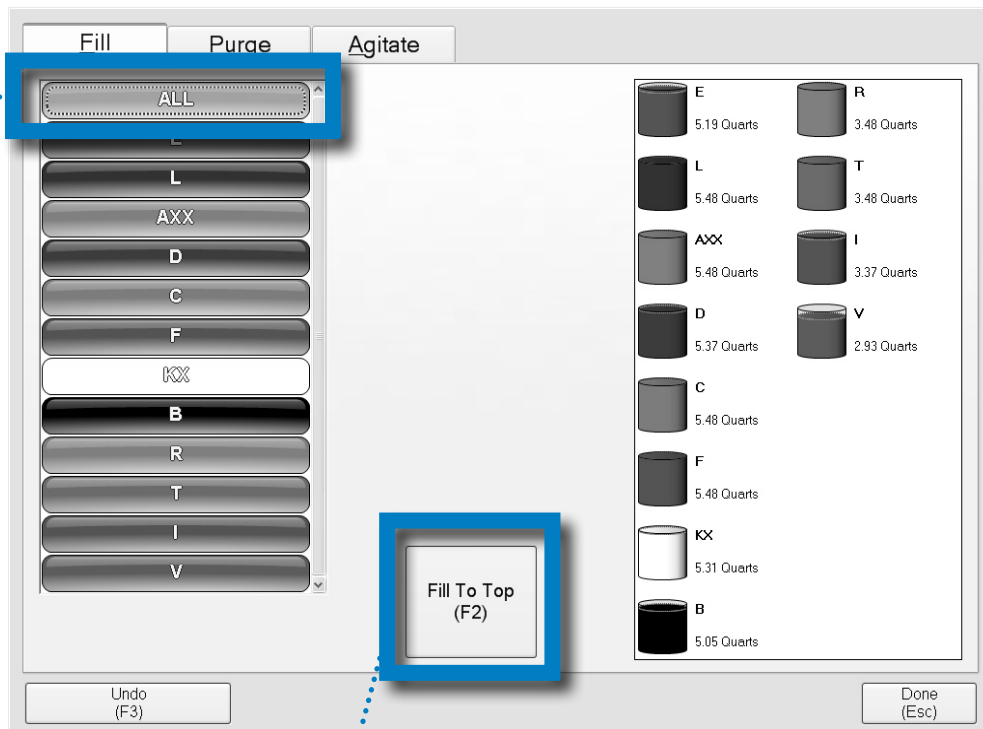

5 Select **Fill To Top (F2)** button.

6 When prompted, "...are you sure?", click **Yes**.

7 Select **Done (Esc)** to return to the Main Menu.

NOTE: When refilling, update the canisters by entering the amount of colorant you added in the text box. Press **Enter**.

NOTE: Repeat entire process for each empty canister.



Getting Started

Preparing the system

After you have filled the canisters and updated the software, you must do an initial dispense to make sure the Accutinter is working properly.

1 From any screen choose **Maintenance (F3 or F11)**.

Smart Purge

Use "Smart Purge" for daily Purging. This will only purge colorants that have not been recently used.

2 Click on the **Purge** tab.

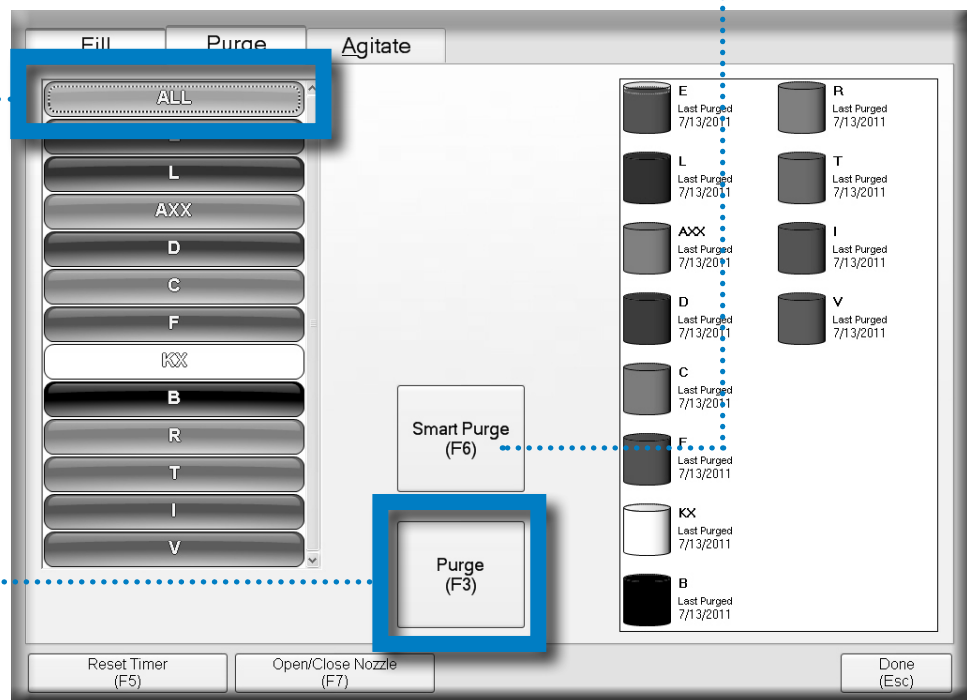

3 Purge colorants. Click on the colorant to be purged or select **ALL** button to purge entire system. Click the **Purge (F3)** button.

4 Place a container underneath the nozzle **with nozzle closer open**.

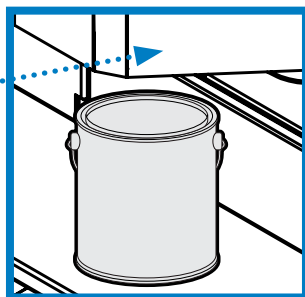

5 Click **Dispense (F2)**. Colorant(s) will dispense. Prompt will appear confirming dispense.

6 Click **Done (Esc)**.



Getting Started

Using the shelves



For 5-gallon containers, place them on the roller conveyor (or optional slide shelf) underneath the nozzle. Use LED lights to triangulate the container hole.



For quart and pint containers, pull out the shelf using the two pulls and place the container underneath nozzle. Use LED lights to align in center of container.



For 1-gallon containers, lower the shelf and place the container underneath the nozzle. Use LED lights to align in center of container.



Basic Operations

Welcome to ColorPro4

ColorPro and ColorPro Professional puts usability at your fingertips with features that allow you to operate your Accutinter 8000Elite dispenser—instantly dispense any formula in your database, perform maintenance, run usage reports, estimate paint coverage for any room, adjust formulas, and calculate the formulas for lightening and darkening paint.

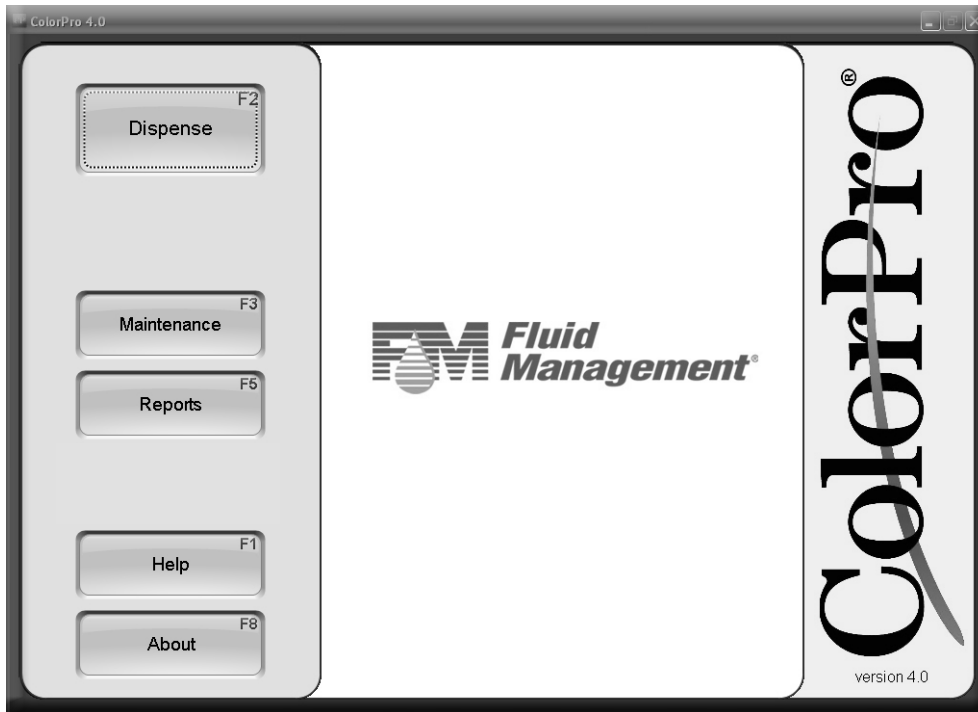

ColorPro4 Features:

- Dispense all your database formulations or manually create your own colors
- Store customer information and color requirements so you can provide consistent service time and time again
- Integrates with spectrophotometer hardware and software
- Customize settings to meet your business volume needs.
- Easy to use screens will assist you in routine maintenance
- Run diagnostics on the machine for quick troubleshooting
- Track and report colorant, machine, and formula usage to assist you in inventory, maintenance and trend management
- All functions can be conducted with mouse or keyboard
- ColorPro translated into a variety of operator languages



Basic Operations

Main menu

The main screen of ColorPro features five selections.

Dispense
Click here to go to the Formula Book, Manual Dispense, and Dispense Queue menus.

Maintenance
Click here to add colorant, purge lines, agitate colorants.

Reports
Click here to run reports for a selected date range in csv.file format.

Help Menu
Click here for training videos to get answers to your ColorPro and Accutinter questions.

About
Click here to see ColorPro and Accutinter information.

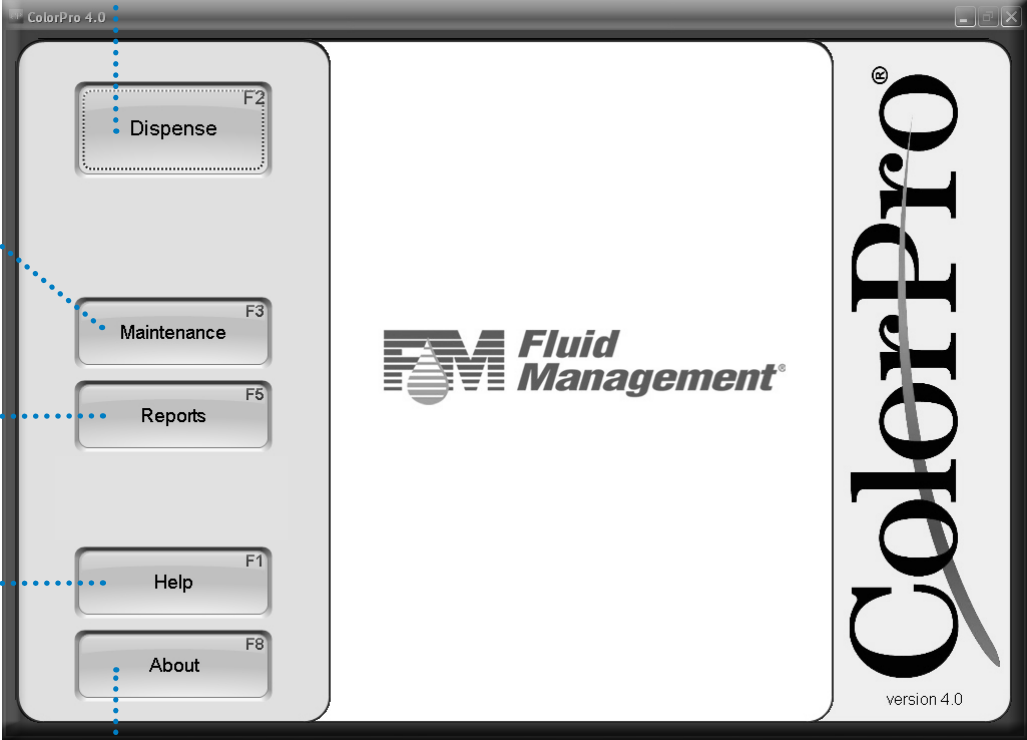

Basic Operations

Dispensing from Formula Book

From the **Main Menu**, choose **Dispense (F2)** button. The **Formula Book** tab allows you to select, dispense, and adjust the formula. You can also estimate paint quantities and enter new formulas.

Clear Formula

To select a new formula or to start over, choose Clear Formula (F9).

Formula Information

Select the Brand of formula you are searching for by using the drop down menus.

Enter the Formula Name or use the drop down menus to search for the Formula Number in your database.

Select the desired Product, Finish, and Container Size using the drop down menus.

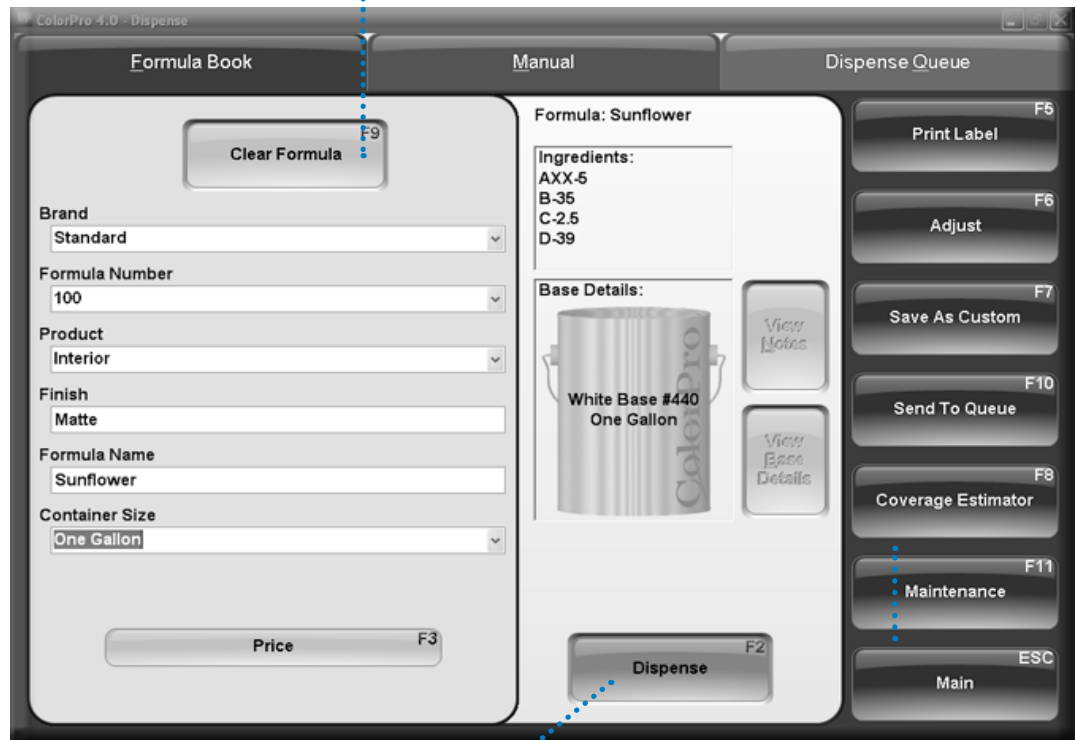

Dispense

Choose Dispense (F2) to dispense the formula now. When dispensing, place container under nozzle. Prompt will appear confirming dispense.

To dispense another container of the same formula, choose Dispense (F2).



Basic Operations

Dispensing from Formula Book

The screenshot shows the ColorPro 4.0 - Dispense software interface. The interface is divided into three main sections: Formula Book, Manual, and Dispense Queue. The Formula Book section on the left contains a 'Clear Formula' button (F9) and several dropdown menus for Brand (Standard), Formula Number (100), Product (Interior), Finish (Matte), Formula Name (Sunflower), and Container Size (One Gallon). A 'Price' button (F3) is located at the bottom of this section. The Manual section in the center displays 'Formula: Sunflower' with a list of ingredients (AXX-5, B-35, C-2.5, D-39) and 'Base Details' for 'White Base #440 One Gallon'. A 'Dispense' button (F2) is at the bottom of this section. The Dispense Queue section on the right contains a 'Print Label' button (F6), an 'Adjust' button (F6), a 'Save As Custom' button (F7), a 'Send To Queue' button (F10), a 'Coverage Estimator' button (F8), a 'Maintenance' button (F11), and a 'Main' button (ESC). A small blue box with the number '2' is in the top right corner of the interface. Dotted lines connect callout boxes to these specific buttons and sections.

Ingredients
The colorant ingredients needed to dispense your formula will show here.

Print Label
Click here to print labels.

Order Queue
This number indicates the number of jobs queuing.

Adjust
Click here (F6) to adjust individual formulas (See page 28).

Save As Custom
Click here (F7) to save as a custom color or customer information.

Send To Queue
Choose Send to Queue (F10) to dispense the formula later.

Price
Click here (F3) to estimate the cost of a job or price for a specific formula (optional).

Coverage Estimator
Click Coverage Estimator (F8) to estimate how much paint is needed for a job.



Basic Operations

Manual dispensing

From the **Main Menu**, choose **Dispense (F2)** button. The **Manual Dispense** tab allows you to select, dispense, and adjust the formula. You can also estimate paint quantities, and enter new formulas.

Enter Amounts

The colorants will be displayed under Selected Ingredients. Type in the shot size of the colorant that you require. Repeat the steps for each colorant in that formula.

Save As Custom

Click here (F7) to save custom formula information

Brand

Select the Brand of paint you are creating a formula for by using the drop down menu.

Ingredients

From the ingredient list, select the first colorant by double clicking on the button.

Get Base

After selecting brand and colorants, click here to select Base and size to dispense new formula info.

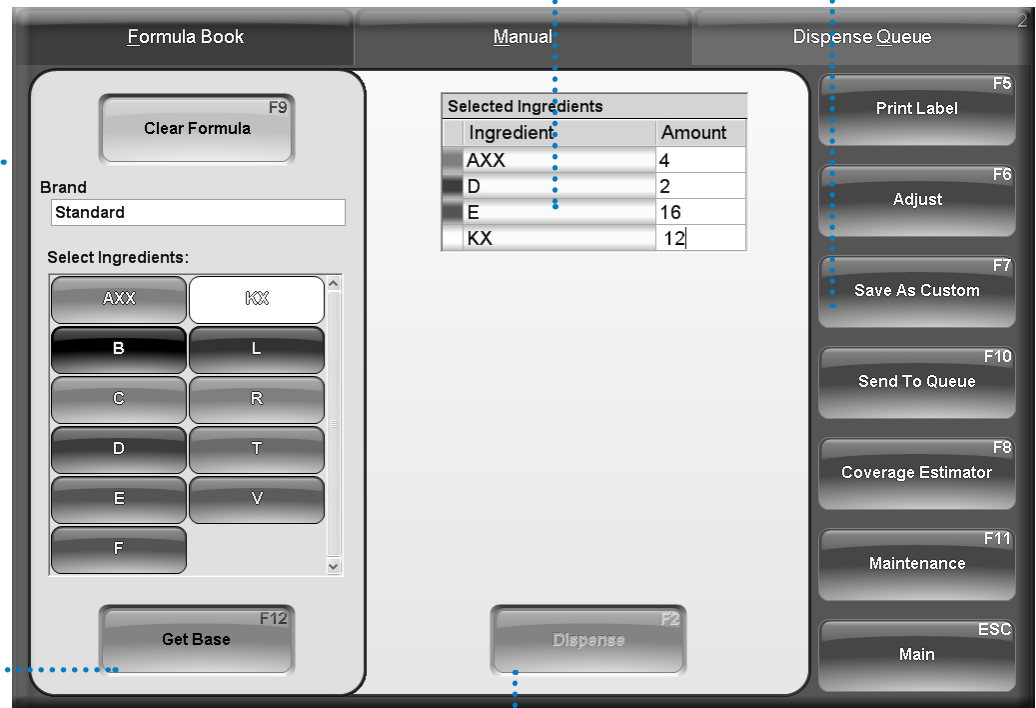

Dispense Now

Dispense now by selecting Dispense (F2).

Or

Send to Queue

Choose to dispense the formula later by selecting Send to Queue (F10).



Basic Operations

Using external data source and dispense queuing

From the **Main Menu**, choose **Dispense (F2)**. The **Dispense Queue** tab allows you to enter and dispense a formula scanned by a spectrophotometer (optional) or from a previous order not yet dispensed.

Order Queue

This number indicates the number of jobs queuing. . . .

Input List

The Input List (F4) displays all the formulas waiting to be dispensed from an external source or previously requested. The number of jobs queuing is located in top right corner.

Search for a job by clicking on any of the input tabs.

Remove Job

Click here to remove the highlighted dispense from the input list.

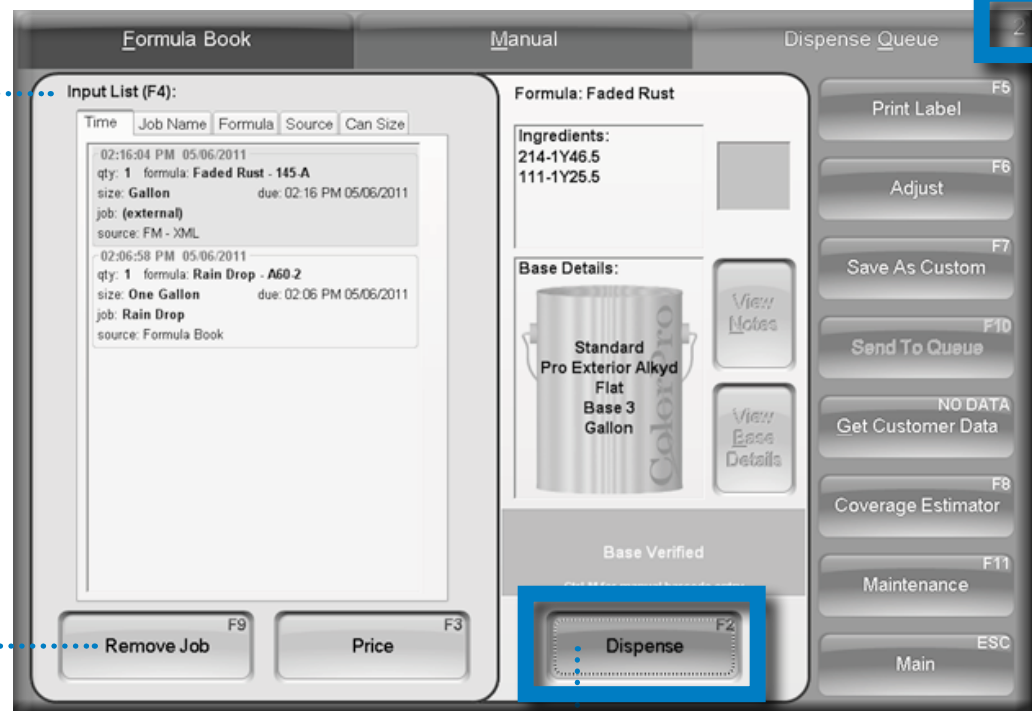

Dispense

Choose Dispense (F2) after selecting the formula from the Input List.



Basic Operations

Adjusting formulas

Color formulas can be modified to adjust lightness, darkness, and modify existing formulas. From any tab in the Dispense Menu, click **Adjust (F6)** after a formula is selected.

Adjust Ingredients

On the Adjust Ingredients tab, the original formula colorant amounts are displayed.

Selected Ingredients

In the Change +/- fields, type the amount to add or subtract from the original formula for each colorant. The totals will change based upon amounts you enter.

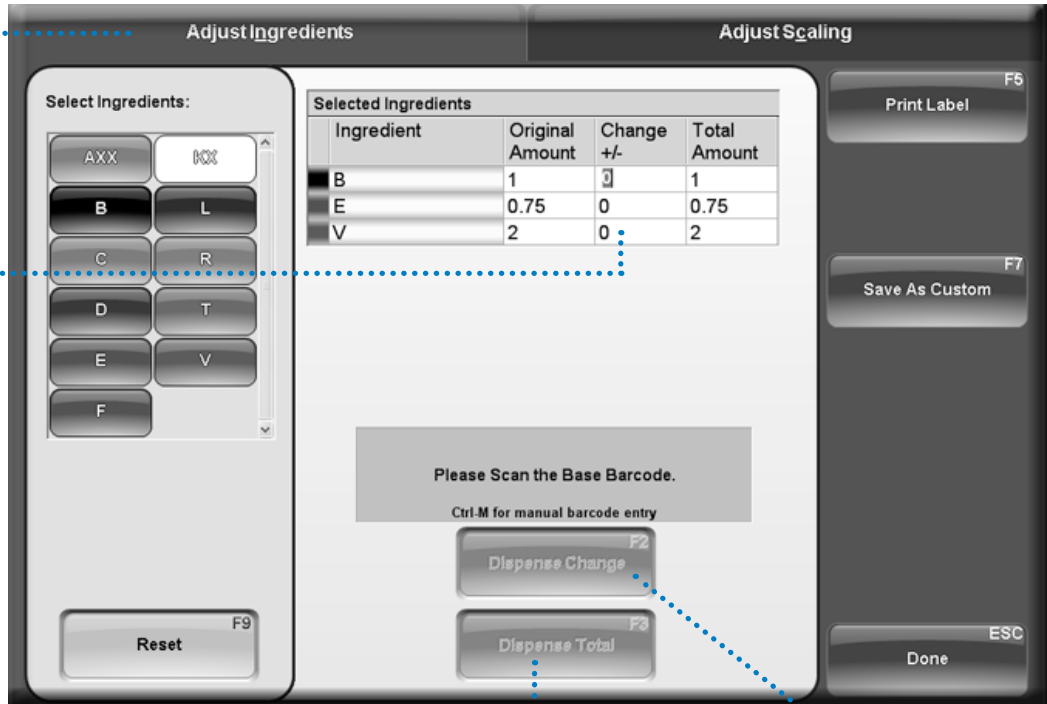

Dispense Total

Click Dispense Total (F3) to dispense the original formula plus adjusted amounts.

Dispense Change

Click Dispense Change (F2) to dispense the incremental added colorant amounts.



Basic Operations

Using color scaling

On the **Adjust Scaling** tab, the original formula colorant amounts are displayed.

Create a deeper or lighter formula by selecting Percent Change and selecting a value from drop down box, or select Container Size and select a different paint container size from drop down box.

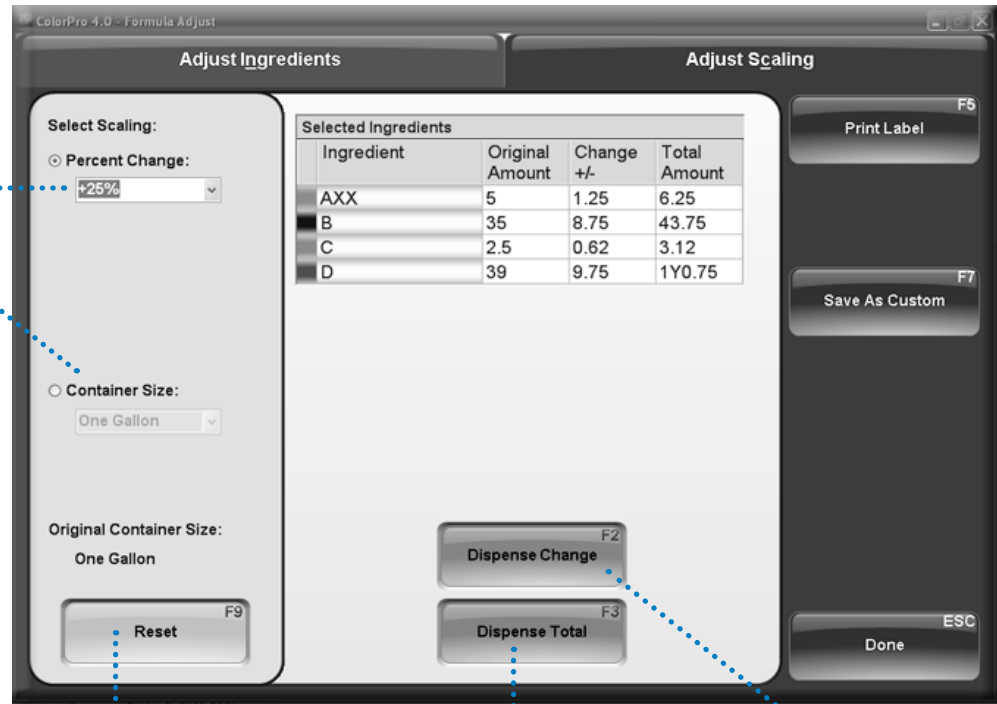

Reset
Click here (F9) to return to original formula settings.

Dispense Total
Click Dispense Total (F3) to dispense the original formula plus adjusted amounts.

Dispense Change
Click Dispense Change (F2) to dispense the incremental added colorant amounts.



Basic Operations

Purging the lines

It is recommended that you complete a purge daily to ensure optimal Accutinter performance and avoid possible mis-tints.

1 From any screen choose **Maintenance (F3 or F11)**.

Smart Purge

Use "Smart Purge" for daily Purging. This will only purge colorants that have not been recently used.

2 Click on the **Purge** tab.

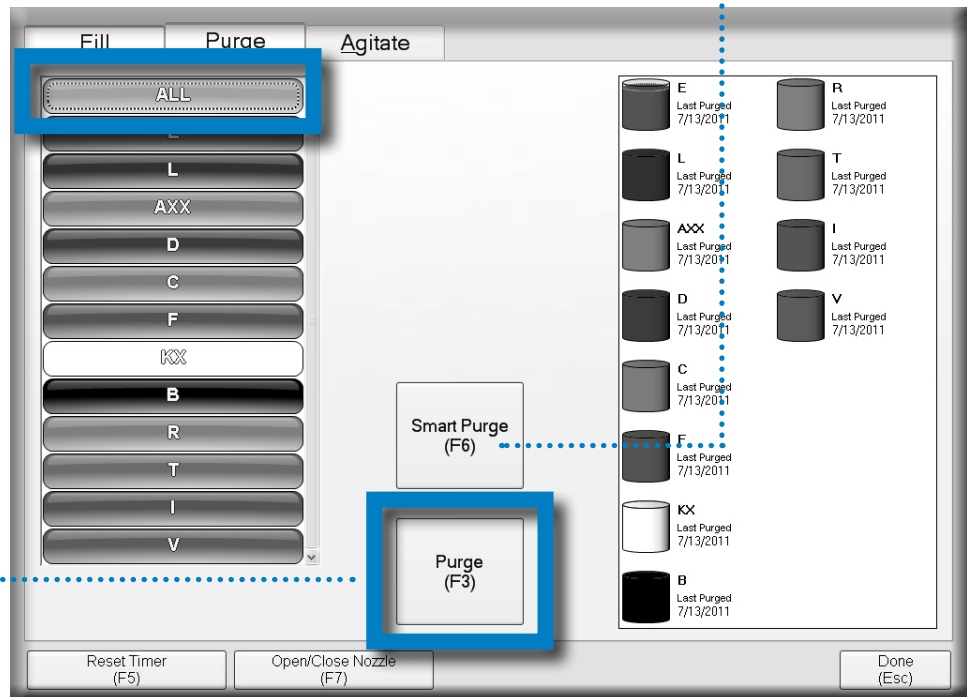

3 Purge colorants. Click on the colorant to be purged or select **All** button to purge entire system. Click the **Purge (F3)** button.

4 Place a container underneath the nozzle **with nozzle closer open**.

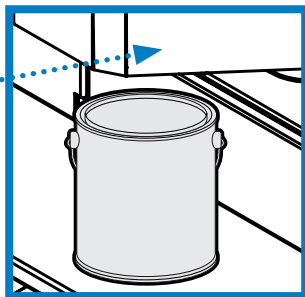

5 Click **Dispense (F2)**. Colorant(s) will dispense. Prompt will appear confirming dispense.

6 Click **Done (Esc)**.



Basic Operations

Stirring the colorants

When adding new colorants or if the colorant has not been used for several days, you may want to manually stir colors. From any screen, choose **Maintenance (F3 or F11)**. The Agitate tab allows you to stir colorants in the canister.

1 Click on **Agitate** tab. In the **Duration in Minutes (F4)** field, type in the amount of time colorants should stir.

2 Click **Agitate (F2)** to begin agitation cycle. Progress bar will appear confirming agitation cycle. Click **Done (Esc)**.



NOTE: The default cycle is 30 seconds per hour. Fluid Management recommends 4 minutes for manual agitation.



Basic Operations

Using ColorPro Help

For additional information on how to operate your Accutinter or ColorPro, click **Help (F1)**. The main screen of ColorPro features six selections.

Accutinter Models

Contains information regarding shelves, container sizes, and dispensing.

ColorPro

Find information about dispensing with ColorPro, maintaining the machine, and customization.

Quick Start Guide

Overviews regarding dispensing, maintaining, and customizing your Accutinter.

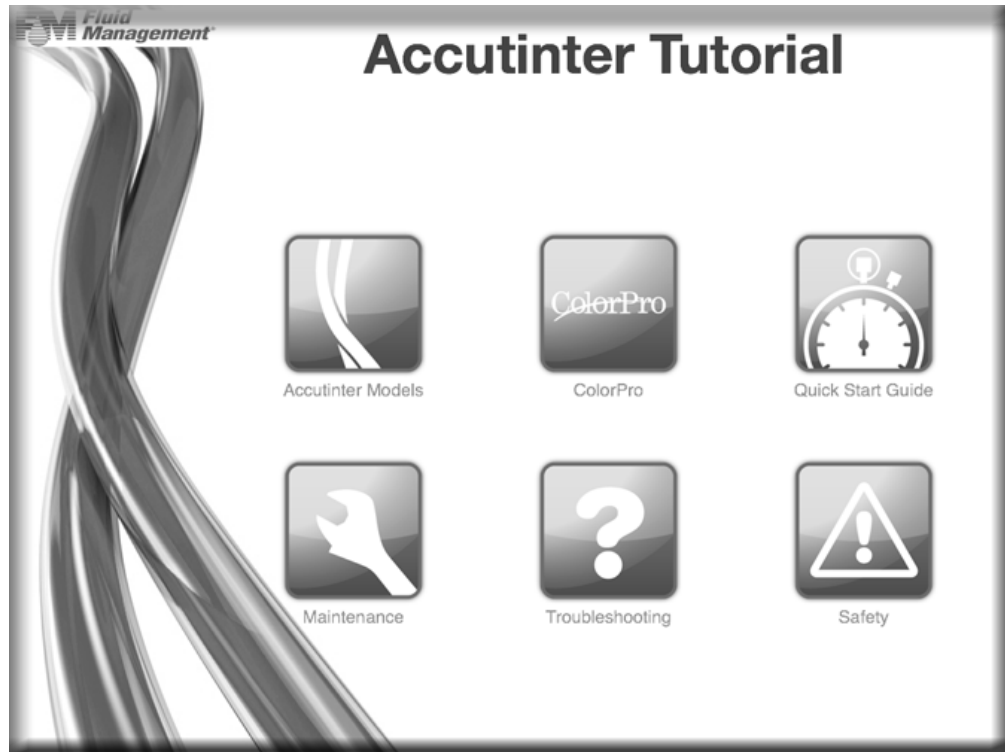

Maintenance

Includes information about canister, nozzle, and preventative maintenance, and line purging.

Troubleshooting

Contains information regarding dispensing, color tinting and other operational issues.

Safety

Important safety instructions to note when operating equipment.



Maintenance, Care and Use

Your Accutinter 8000*Elite* depends on clean and well maintained parts. To ensure dispensing accuracy and increase the operation of your Accutinter 8000*Elite*, follow the maintenance schedule detailed below:

PERFORM EVERY DAY:

- Clean each of the nozzles with the recommended nozzle cleaning tool and purge (see below).
- Remove all excess colorant and debris from the nozzle and nozzle area.
- Clean all accessible surfaces and cabinet with a mild cleaning solution.
- Empty and clean the drip tray. Replace if necessary.
- Moist sponge daily to keep colorant from drying.

PERFORM EVERY WEEK:

- Clean the spill trays around canisters.

PERFORM EVERY SIX MONTHS:

- Check the calibration and re-calibrate as required.*

*This should be performed by a Fluid Management authorized service technician.

Your Accutinter 8000*Elite* will perform best if the nozzle and colorant lines are purged and cleaned every day. If you use your machine frequently, Fluid Management recommends cleaning and purging the nozzle at least once a day. The instructions for daily nozzle cleaning are below. For filling the colorant canisters, go to page 17.

Do not clean the equipment with a water jet.

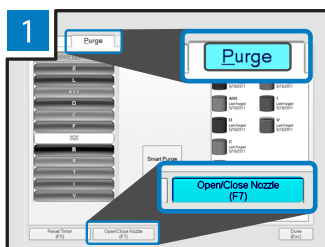

Open nozzle closer

- Click Maintenance (F11)
- Choose Purge tab
- Click Open/Close (F7)

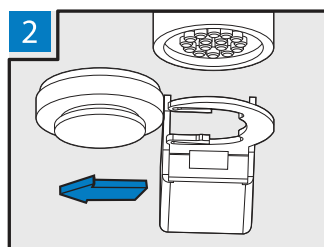

Remove cup holder from nozzle closer

- Slide black cup holder left
- Remove cup from bracket and place to the side

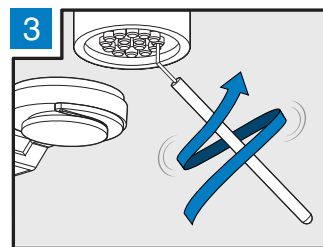

Clean nozzle

- Clean each opening with included nozzle cleaning pick
- Use a circular motion to make sure opening is clear

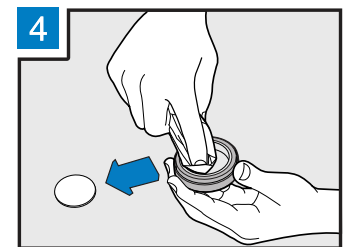

Clean cup

- Remove sponge insert
- Clean inside of cup liner with water and paper towel

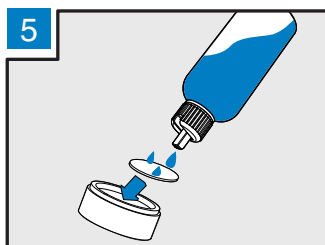

Replace sponge

- Replace sponge insert
- Moisten sponge with water
- Replace cup holder to closer bracket

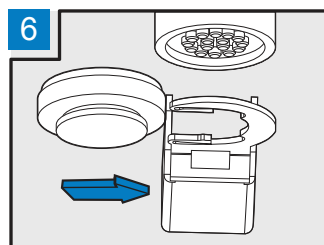

Replace cup holder to nozzle closer

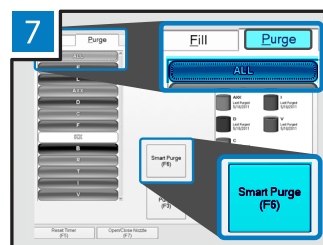

Purge colorants

- Click Maintenance (F11)
- Choose Purge tab
- Click All
- Click Purge (F3)
- Click Dispense (F2)

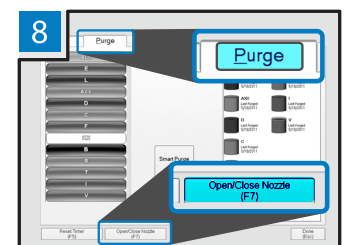

Close nozzle closer

- Click Maintenance (F11)
- Choose Purge tab
- Click Open/Close

NOTE: Environmental Conditions: Operating temperature between 50° F (10° C) and 104° F (40° C)
The A-weighted sound pressure is below 70 dB.



Frequently Asked Questions

Equipment troubleshooting

Most of the problems listed in this section can be prevented by daily cleaning and by purging the nozzle. See the **Maintenance, Care and Use** section in this manual for instructions.

Use the chart below to locate the problem and perform the recommended actions in the last column.

Contact **Fluid Management Customer Service** if you are unable to find a resolution.

PROBLEM	FIRST CHECK:	ACTION
The machine is dispensing mis-tints.	<p>...Do the fill settings in ColorPro match what is inside the canister?</p> <p>...Have the nozzle openings been cleaned recently?</p> <p>...Is the Accutinter dispensing accurately?</p>	<p>Compare the canister contents with the fill settings. Adjust if necessary:</p> <ol style="list-style-type: none"> 1- Look inside the canister and compare the contents with what the fill settings in ColorPro show. 2- If they do not match, fill the canister and adjust the colorant level in ColorPro (see page 17). <p>Clean the nozzles:</p> <ol style="list-style-type: none"> 1- Clean each nozzle opening with a nozzle cleaning tool. 2- Remove all excess colorant from around the nozzles (see page 31). 3- Purge the lines with ColorPro (see page 28). 4- Repeat cleaning and purging if necessary. <ul style="list-style-type: none"> ▪ Dispense one ounce of each colorant into a marked measuring container. If you notice any colorants are not dispensing, call Customer Service for assistance.
The colorant shoots to the side during a dispense.	<p>...Have the nozzles been cleaned recently?</p>	<ol style="list-style-type: none"> 1- Clean the nozzle. Remove all excess colorant and dried debris. 2- Purge the colorant line. 3- Repeat if necessary.



Frequently Asked Questions

Equipment troubleshooting

PROBLEM	FIRST CHECK:	ACTION
The nozzle closer is not opening or closing.	...Is the nozzle closer covered with dried colorant and debris?	<ul style="list-style-type: none"> ▪ Clean all dried colorant and debris from the nozzle closer area. Make sure the nozzle arm is clean so it moves freely. ▪ If the nozzle closer still does not close, call Customer Service.
Colorant drips or runs after dispensing.	<p>...Is ColorPro prompting you to fill the canister?</p> <p>...Do the nozzle openings need to be cleaned?</p> <p>...Does the colorant have air in it?</p>	<ol style="list-style-type: none"> 1- If yes, fill the canister with colorant (see page 16). 2- Agitate for up to three minutes. 3- Purge the line. <ul style="list-style-type: none"> ▪ If the canister is full, clean the nozzle and complete a purge using ColorPro (see page 28). Repeat if necessary. ▪ Complete a purge using ColorPro (see page 28). Repeat if necessary.
A colorant canister needs to be filled.		<ul style="list-style-type: none"> ▪ Follow the “Preparing and refilling canisters” instructions on page 16.
The canister cover and lids need to be cleaned.		<ul style="list-style-type: none"> ▪ Soak the canister covers in hot water and mild detergent. Wipe off the excess debris and dried colorant when the colorant has loosened. ▪ Scrape the excess colorant off with a putty knife.
The colorant coming out of the nozzle is drippy or clumpy.	...Do the nozzle openings need to be cleaned?	<ul style="list-style-type: none"> ▪ Clean the nozzle openings and purge the lines (see page 31). The colorant should come out of the nozzle in a steady stream.



Frequently Asked Questions

Equipment troubleshooting

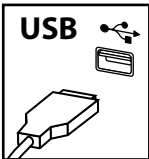
PROBLEM	FIRST CHECK:	ACTION
The machine is not dispensing.	...Is the machine turned on and plugged in?	<ul style="list-style-type: none"> ▪ Make sure the power cord is plugged in. ▪ Restart the machine: <ol style="list-style-type: none"> 1- Exit ColorPro. 2- Shut down the computer. 3- Press the reset switch on the front of the keyboard tray. 4- Wait 30 seconds. 5- Turn the computer back on. ▪ If the problem still persists, call Customer Service.
There is no power.	<p>...Is the machine turned on and plugged in?</p> <p>...Is there power at the receptacle?</p> <p>...Is the surge protector turned on?</p>	<ul style="list-style-type: none"> ▪ Make sure the power cord is plugged in. Replace the power cord if damaged. ▪ Check the circuit breaker ▪ Turn on the surge protector; replace if necessary.
The printer is not printing.	<p>...Is the power cord firmly connected to the computer and functioning properly?</p> <p>...Is the USB cable connected at both ends?</p> <div style="text-align: center;">  </div>	<ul style="list-style-type: none"> ▪ Make sure the printing device is properly connected. ▪ Unplug the power to the printer for 30 seconds and then replug. Try to print again. ▪ Restart the computer. After restarting, print again. ▪ If you still have problems, after following these suggestions, contact the printer manufacturer at 1.800.426.7827
The motor is running erratically or not at all.	...Is the dispenser on a dedicated line?	<ul style="list-style-type: none"> ▪ If no, plug the dispenser into a dedicated 115 or 220 Volt line.



Frequently Asked Questions

Equipment troubleshooting

PROBLEM	FIRST CHECK:	ACTION
One or two colorants are not dispensing.	...Are the nozzles clogged?	Follow the daily nozzle cleaning instructions (see page 31) for your model.
How do I clean the nozzle openings?		<ul style="list-style-type: none"> ▪ Follow the daily nozzle cleaning instructions (see page 31). <p>OR</p> <ul style="list-style-type: none"> ▪ Follow the “Daily Nozzle Cleaning Instructions” on the inside of the top cover of your machine.
The computer doesn't start when you press the power button.	...Is the power cord plugged in?	<ul style="list-style-type: none"> ▪ Make sure the power cord is plugged into the rear of the computer and to a working electrical outlet.
The monitor screen is blank.	...Is the power turned on and are the cables attached?	<ul style="list-style-type: none"> ▪ Make sure the USB cable is plugged into the back of the monitor and to the back of the computer. ▪ Make sure the power cord is plugged to the back of the computer and to a working electrical outlet. ▪ Make sure the recommended surge protector is turned on.
The keyboard isn't responding.	<p>...Are all the cables securely attached between the computer and the keyboard?</p> <p>...Are all the cables securely attached between the computer and the keyboard?</p> <p>...Does the keyboard need replacing?</p>	<ul style="list-style-type: none"> ▪ If not, firmly attach all cables. ▪ Replace the keyboard.



Frequently Asked Questions

ColorPro troubleshooting

PROBLEM	FIRST CHECK:	ACTION
<p>General ColorPro related</p>	<p>...Make sure ColorPro is installed.</p> <p>...Try re-starting the machine to see if that solves the problem.</p> <p>...Can you find the answer in the Help section of ColorPro?</p> <p>...Make sure your computer is properly connected.</p>	<ul style="list-style-type: none"> ▪ Turn on the computer. Does the ColorPro main screen open up? If yes, then ColorPro is installed. ▪ Press the restart switch on the front of the keyboard tray. ▪ Look in Help for instructions and troubleshooting information. ▪ Make sure the communication cable connects the computer to the dispenser. ▪ If screen savers have been installed recently, they may conflict with ColorPro. Uninstall the screen savers. ▪ Restart the computer. Press the on/off button of the computer. Wait thirty seconds and turn the computer back on. ▪ If none of these suggestions work, call Customer Service.
<p>A message in ColorPro says, "<i>Communication to dispenser has been severed. Recheck connections and try again.</i>"</p>	<p>...Make sure the communication cable is connected between the computer and the machine.</p>	<ul style="list-style-type: none"> ▪ Exit ColorPro. ▪ Shut down the computer. ▪ Restart the computer. Press the red button on the right side of the computer. Wait 30 seconds and turn the computer back on. ▪ If you still receive the message, call Customer Service.



Frequently Asked Questions

ColorPro troubleshooting

PROBLEM	FIRST CHECK:
A message in ColorPro says, “Encoder pulse failure. Motor failed on canister containing...”	<ul style="list-style-type: none"> ▪ Call Customer Service.
The optional barcode scanner does not work...	<ul style="list-style-type: none"> ▪ You must have ColorPro Professional for barcoding capability; ▪ Make sure the Barcode Scanning Enabled box is checked in FM_Customizer (see pages 14-15).
If you suspect a problem with the label printer...	<ul style="list-style-type: none"> ▪ Contact the printer manufacturer at 1.800.426.7827
If you suspect a problem with the colorants...	<ul style="list-style-type: none"> ▪ Contact your department manager or store manager.



Service

FMDirect

Fluid Management products are backed by FMDirect, our nationwide team of phone and field service engineers. Providing you with local, hands-on support, over 30 factory-direct service technicians deliver expertise when and where you need it.

- 24/7 multilingual tech support
- Professional installation and on-site operator training
- Fully-stocked parts inventory on FMDirect vans
- Extended warranty and preventive maintenance programs

Upgrades and Replacement Parts

Some parts can be upgraded or replaced by the customer. Fluid Management expressly identifies parts as such, and provides documentation with instructions when it is appropriate for customers to replace those parts. You must closely follow all instructions when performing such replacements. **ALWAYS** make sure that the power is turned off and that the product is unplugged from any power source before you attempt the replacement.

DO NOT attempt to service a product yourself unless instructed to do so by a Customer Service Representative. Use only a service provider who is approved to repair your particular product.

Obtain Warranty Service

First, follow the advice in this guide. If the unit still does not function, call Customer Service for information about how to obtain warranty service.



Fluid Management Customer Service 1.800.462.2466

Save time and money. If something should go wrong, we suggest consulting the **Maintenance, Troubleshooting** and **Service** sections of this guide. They are designed to solve basic problems before consulting a service technician.

However, should you need assistance, please have your model and serial number ready. Be near your machine when you call and have a purchase order number if ordering parts.

Fluid Management[®]

SERIAL NO. _____

MODEL NO. _____

PN 4980001

1 800 462 2466 MADE IN USA
1023 Wheeling Road, Wheeling, Illinois 60090-5776

The serial plate is located underneath the lid of the machine. It includes the serial and model numbers for your machine. Please make a note of these numbers below:

Date of purchase: _____

Model Number: _____

Serial Number: _____

Your Service Technician's Name: _____



Fluid Management Statement of Limited Warranty 2014

WARRANTY COVERAGE

Fluid Management, Inc. ("Fluid Management") warrants all Fluid Management Accutinters, Manual Paint Dispensers, and Paint Mixers and Shakers ("Paint Equipment") to be free of defects in material and workmanship during normal operation, use and service for a period of two years from the date of shipment by Fluid Management.

For Paint Equipment installed and used at a location in the United States or Canada

The first year of the warranty period covers parts and labor. If any Paint Equipment fails during normal operation, use and service during the first year of the warranty period due to a defect in material or workmanship, Fluid Management will repair the defective Paint Equipment and replace any defective parts at no charge to the Customer. The warranty repairs and defective parts replacement will be carried out by Fluid Management or one of its Authorized Service Representatives.

The second year of the warranty period covers parts only. If any Paint Equipment fails during normal operation, use and service during the second year of the warranty period due to a defect in material or workmanship, Fluid Management will provide Customer with a replacement for any defective parts at no charge to the Customer. Customer will be responsible for all labor.

For Paint Equipment installed and used at a location outside the United States and Canada

The first year and second years of the warranty period covers parts only. If any Paint Equipment fails during normal operation, use and service during the first or second year of the warranty period due to a defect in material or workmanship, Fluid Management will provide Customer with a replacement for any defective parts at no charge to the Customer. Customer will be responsible for all labor.

WARRANTY CLAIMS

Warranty claims must be asserted during the warranty period. While Paint Equipment is under warranty, no repair or part replacement should be undertaken without first contacting Fluid Management at 800-462-2466. To expedite the process, the model and serial numbers of the Paint Equipment should be available at the time of the call.

WARRANTY CONDITIONS, EXCLUSIONS AND LIMITATIONS

- Fluid Management shall have no liability or obligation under its warranty in connection with any warranty claim asserted or any failure or malfunction occurring after the expiration of the warranty period.
- As a condition to any warranty repair or part replacement, Fluid Management shall have the right to first inspect, test and evaluate the Paint Equipment and parts that are claimed to be defective.
- Return of Paint Equipment and parts to Fluid Management requires a Return Goods Authorization (RGA) from Fluid Management, and the RGA number must be included with any returned Paint Equipment or part.
- Customer shall be required to provide Fluid Management and its Authorized Service Representatives with all information that any of them may request concerning the maintenance, operation, use, service, failure or malfunction of Paint Equipment and parts that are claimed to be defective.
- Fluid Management may use reconditioned parts for warranty repairs and parts replacement.
- Warranty repairs and part replacement do not extend the warranty period for Paint Equipment and repaired Paint Equipment and replacement parts are warranted only for the remainder of the original warranty period.
- Any repair or replacement requested as a warranty repair or replacement that is not covered by Fluid Management's warranty will be billed to Customer as non-warranty repair or replacement on a time and materials basis.

*Excludes Blendorama Model 22CW Manual Dispensers, and X-Smart Automatic Dispensers, for which Fluid Management provides separate equipment specific limited warranties



Fluid Management Statement of Limited Warranty 2014

WARRANTY CONDITIONS, EXCLUSIONS AND LIMITATIONS (CONT.)

- Fluid Management's warranty transfers to the new owner with transfer of ownership Paint Equipment. It is the responsibility of new owner to notify Fluid Management at 1-800-462-2466 of the transfer of ownership of Paint Equipment. Transfer of ownership does not extend the warranty period.
- Fluid Management's warranty does not cover, extend or apply to, or include:
 - Computer or computer-related equipment such as laptops, monitors and printers and other third-party equipment supplied with Paint Equipment (In the case of computer and computer-related equipment such as laptops, monitors or printer, and other third-party equipment, any warranty is limited to a pass through to Customer of any warranty received from the equipment manufacture, and is subject to whatever terms, conditions and limitations are imposed by the equipment manufacturer)
 - Third-party software supplied with Paint Equipment (In the case of third-party software, any warranty is limited to a pass through to Customer of any warranty received from the software provider and is subject to whatever terms, conditions and limitations are imposed by the software provider)
 - Normal wear and tear
 - Any computer or computer-related equipment, other peripheral equipment, accessories, formulations, software or other items provided by anyone other than Fluid Management, including Customer
 - Any Paint Equipment or part failure or malfunction that Fluid Management or one of its Authorized Service Representatives determines to have been caused by or attributable to any computer or computer-related equipment, other peripheral equipment, accessories, formulations, software or other items provided by anyone other than Fluid Management, including Customer
 - Any Paint Equipment or part failure or malfunction that Fluid Management or one of its Authorized Service Representatives determines to have been caused by or attributable to damage during or after shipment, colorant in the wrong canister, colorant related issues (e.g. beads in colorant, colorant contamination, colorant thickening, changes in colorant viscosity, defective/recalled colorant, etc.), overfilling of canisters, improper operation or misuse, lack of daily maintenance, power surge, power outage, voltage incompatibility, fire, flood, water leakage, accident, acts of god, casualty, or other similar causes. (For the avoidance of doubt, issues with motors, circuit boards and other electrical components that could have been avoided with the use of a use a power conditioner are not covered)
 - Any Paint Equipment or part that Fluid Management or one of its Authorized Service Representatives determines was tampered with, disassembled, repaired, modified, altered, changed or otherwise worked on by anyone other than Fluid Management or one of its Authorized Service Representatives without the prior written authorization of Fluid Management, used to mix or dispense material that the Paint Equipment was not designed to mix or dispense or otherwise used for a purpose or under conditions that differ from those for which the Paint Equipment was designed, or subjected to abnormal use or service, or has had its serial number removed or altered (If Paint Equipment is tested and certified for use with a particular colorant or paint base, and such Paint Equipment is used with a colorant or paint base other than the particular colorant or paint base for which it was tested or certified or the colorant or paint base for which it was tested and certified is modified, altered or changed in any way by the manufacturer or otherwise, such Paint Equipment shall be deemed to have been "used to mix or dispense material that the Paint Equipment was not designed to mix or dispense")
 - Field repair, removal, installation, reinstallation or other similar tasks not performed by Fluid Management or one of its Authorized Service Representatives
 - Cabinets and structural frames
 - Mistints or misfills



Fluid Management Statement of Limited Warranty 2014

WARRANTY DISCLAIMERS AND LIABILITY LIMITATIONS

THE ABOVE WARRANTY IS THE SOLE AND EXCLUSIVE WARRANTY MADE BY FLUID MANAGEMENT WITH RESPECT TO EQUIPMENT, COMPONENTS OR PARTS AND IS IN LIEU OF ALL OTHER WARRANTIES, EXPRESS OR IMPLIED, INCLUDING, BUT NOT LIMITED TO, ALL WARRANTIES OF MERCHANTABILITY AND FITNESS FOR A PARTICULAR PURPOSE, ALL OF WHICH OTHER WARRANTIES ARE EXPRESSLY EXCLUDED.

THE OBLIGATIONS, RIGHTS AND REMEDIES SET FORTH ABOVE ARE THE SOLE AND EXCLUSIVE OBLIGATIONS OF AND SOLE AND EXCLUSIVE RIGHTS AND REMEDIES AGAINST FLUID MANAGEMENT WITH RESPECT TO ANY ALLEGED DEFECT OR DEFICIENCY IN ANY PAINT EQUIPMENT, COMPONENTS OR PARTS.

UNDER NO CIRCUMSTANCES SHALL FLUID MANAGEMENT OR ANY OF ITS AUTHORIZED SERVICE REPRESENTATIVES HAVE (I) ANY LIABILITY FOR ANY CLAIM, LOSS, DAMAGE, INJURY, LIABILITY, OBLIGATION, COST OR EXPENSE THAT DIRECTLY OR INDIRECTLY RELATES TO OR ARISES OUT OF THE PERFORMANCE OF ANY SERVICES OR THE USE, FAILURE OR MALFUNCTION OF ANY EQUIPMENT, COMPONENT OR PART OR (II) ANY LIABILITY FOR INDIRECT, SPECIAL, PUNITIVE OR CONSEQUENTIAL DAMAGES, INCLUDING, BUT NOT LIMITED TO, LOSS OF SALES, LOSS OF PROFITS, LOSS OF MATERIAL BEING DISPENSED, DOWN TIME, LOSS OF PRODUCTION, LOSS OF CONTRACTS, OR DAMAGE TO REPUTATION OR GOOD WILL, WHETHER OR NOT FLUID MANAGEMENT OR ANY OF ITS AUTHORIZED SERVICE REPRESENTATIVES WAS AWARE OF OR ADVISED OF THE POSSIBILITY OF SUCH DAMAGES.

IN ANY EVENT, FLUID MANAGEMENT'S TOTAL LIABILITY IN CONNECTION WITH ANY INDIVIDUAL ITEM OF PAINT EQUIPMENT SHALL LIMITED TO THE NET PRICE PAID TO FLUID MANAGEMENT FOR SUCH ITEM OF PAINT EQUIPMENT.



Index

A

accessories 8
adding colorant 16-17
adjusting formulas 26

B

barcode scanner 8, 11-12, 14-15, 38

C

cabinet, about the 8, 32
canisters 5, 8, 11-12, 16-18, 34
cautions 5-7
cleaning your Accutinter 33
colorant 8-9, 11-12, 16-18, 22-29, 33-34, 36, 38
ColorPro 5, 9, 12, 16, 21-24, 29-32
ColorPro help 30
computer 6, 8, 9, 11, 12
connecting
 to a Spectrophotometer 12
 to the computer 11, 12
 to a monitor 11, 12
coverage estimator 23
custom formula 24, 27

D

database 9, 20, 22, 24
diagnostics 9, 20
dispense 5, 8, 9, 11-12, 16, 20-26, 29
DVX 8

F

filling canisters 9, 11, 16-17, 29
formulas 20, 22-26
formula book 21, 22
fuses 11

G

grounding 7

I

installation 7, 10-12

K

keyboard 8, 10-12, 14-15, 36

L

labels 5, 6, 11-13, 23, 38

M

maintenance 5, 8-9, 11, 17, 21, 30-31
mis-tints 28, 32
monitor 6, 8-12,

N

nozzle 5, 8, 9, 11, 28, 30-34, 36
nozzle cleaning tool 38

P

preventative maintenance 5, 9
printer 8-9, 11, 13, 35, 37
pumps 9
purge 5, 9, 21, 28, 32

R

replacement parts 6
reports 20-21
reset 27

S

safety 5-7
scaling percentages 27
screen savers 9
service 1, 5-9, 30-31, 38,
shaking colorant 9, 11
spectrophotometer 9, 12, 25

T

troubleshooting 5, 9, 33-37

U

upgrading software 17, 21
USB cable 10, 12
usage reports 20
utilities 21, 30

W

WARNINGS 6, 7, 11
warning labels 5, 6
warranty 40



Accutinter 8000*Elite*

Fluid Management, Inc.
1023 Wheeling Road • Wheeling IL 60090
p: 800.462.2466
f: 847.537.3221
www.fluidman.com

