

# SIGNPRO<sup>®</sup>

S Y S T E M S

## // VOLUME 8 WAYFINDING SIGN SYSTEMS

17"  
frame dimension

18.19"

17.15/16"

graphic dimension

2022 ISSUE 1

THE SIGN MAKERS'<sup>®</sup>  
**HAND  
BOOK**  
WAYFINDING SYSTEMS

# TABLE OF CONTENTS

---

## ■ FLAT WAYFINDING

WALL SIGNS	3
PROJECTING SIGNS	8
SUSPENDED SIGNS	10
TRIANGULAR SIGNS	11

## ■ CURVED WAYFINDING

WALL SIGNS	13
DIRECTORIES	16
PROJECTING SIGNS	20
SUSPENDED SIGNS	22
TRIANGULAR SIGNS	24

## ■ SNAPPING SOLUTIONS

POSTER FRAMES	26
PROJECTING	28
SUSPENDED	29

## ■ STANDING SIGN SOLUTIONS

PYLONS & INFO CENTERS	31
-----------------------	----



## Introducing: FLAT SYSTEM

- //Modern Flat Shape
- //Round or Square Profile
- //Black or Silver
- //Customized Options

Perfect systems for directional guidance in offices, hospitals, retailers, schools to help visitors navigate through the building with ease.

SignPro Systems® (SPS) provides affordable, modular wayfinding signage to the trade. From wall frames to self-standing pylon directories and everything in between, SignPro offers the directional indoor signage your clients need. SPS is proud to boast ever-increasing custom capabilities; we can build frames and signs suited to your exact specifications.



## CURVED SYSTEM

- //Sleek Curved Shape
- //Black or Silver or combination thereof
- //Customized Options

SignPro frames accommodate a multitude of sign substrates, from printed paper inserts mounted with your protective lens, to laminated prints, cut vinyl, photopolymer, ADA faces, engraved plastics, metal and more. We ensure to work with you based on the material best suited for the project.

Made in the **USA** // **AFFORDABLE** // **FAST**

# INTRODUCTION



## FLAT SYSTEM

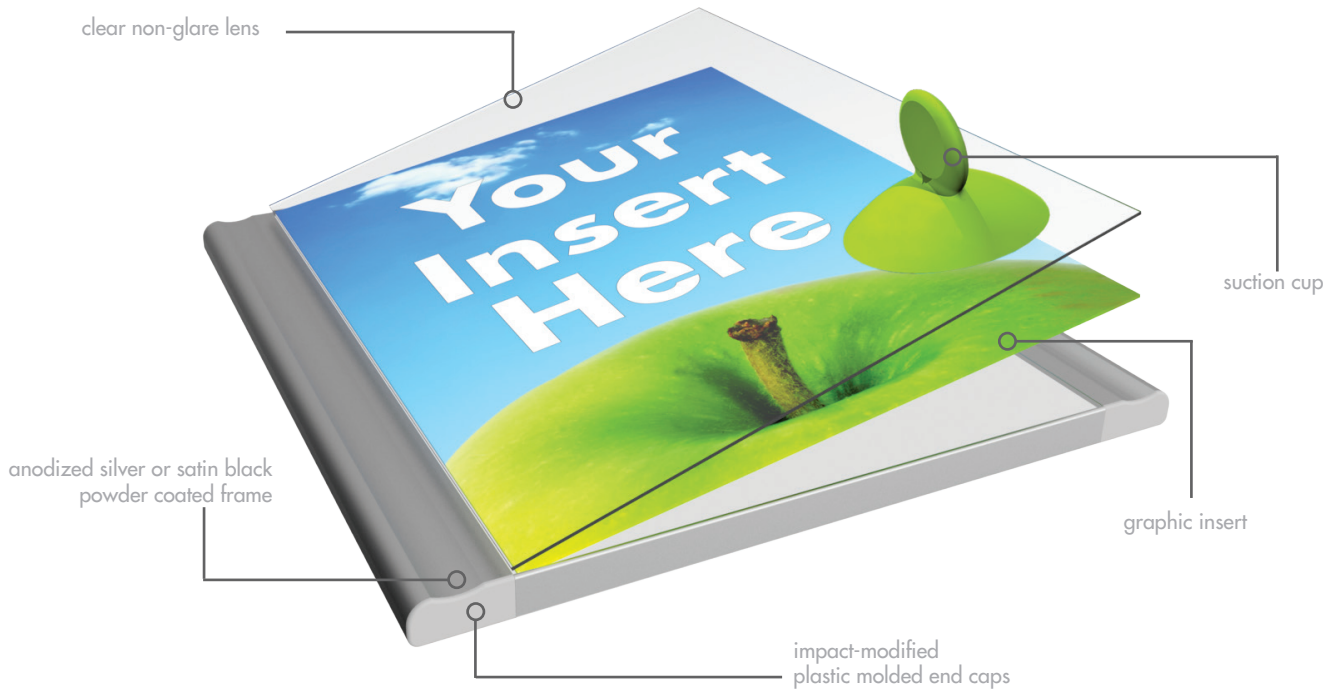

- \\ Aluminum frame extrusions are offered from 6" to 32" wide, at varying heights
- \\ Frames include round or square-shaped profile
- \\ Frames are available in anodized silver or powder-coated black
- \\ Plastic end caps are offered in gray or black
- \\ Frames come standard with a clear, non-glare lens
- \\ Tape mounting included, holes are an additional cost
- \\ Custom lengths available



■ Frame Size ■ Graphic Dims ■ Visible Area PREFIX: Add "FLAT-" to each listed code

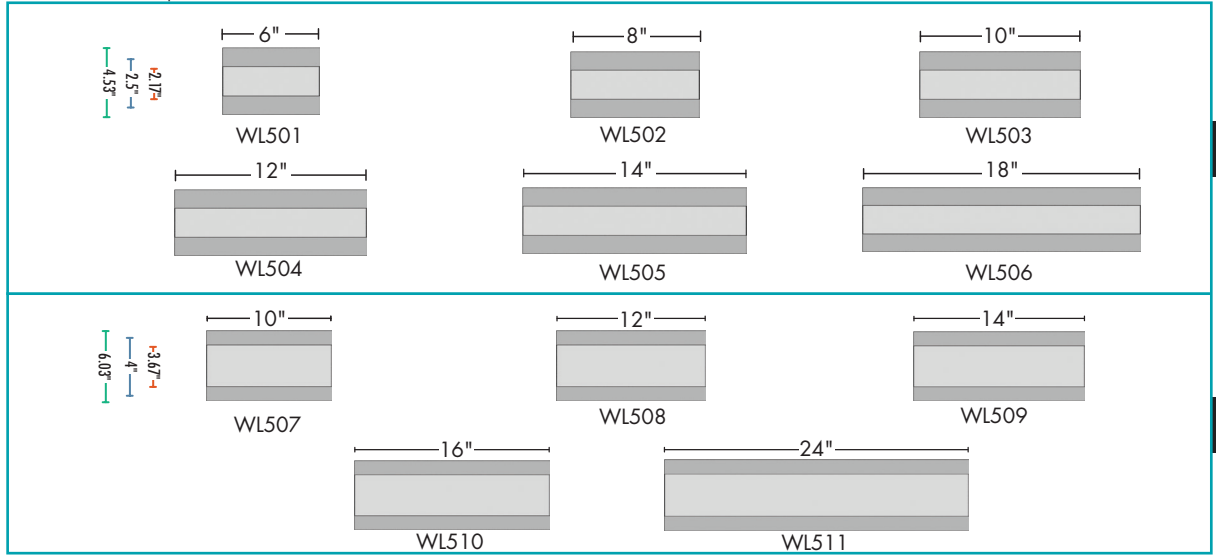

2.5

4

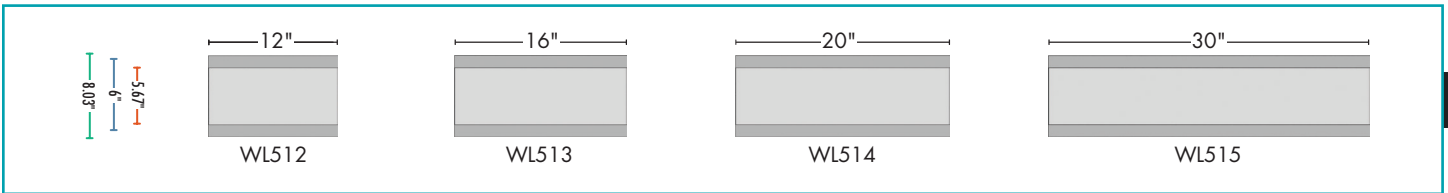

6

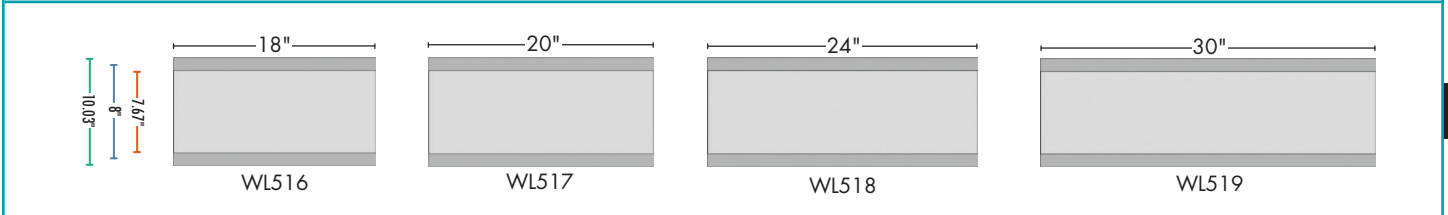

8

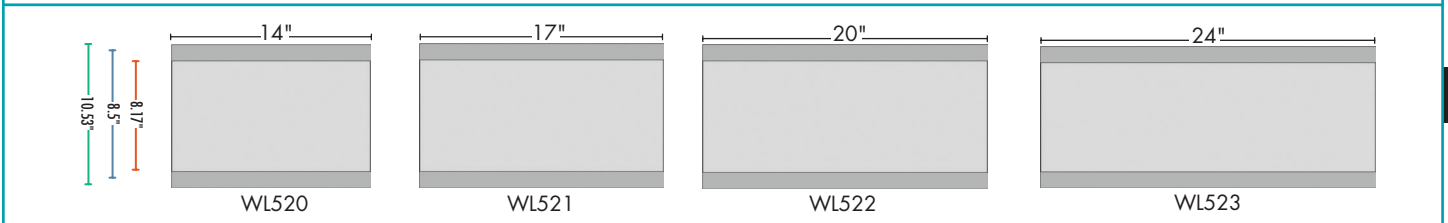

LETTER

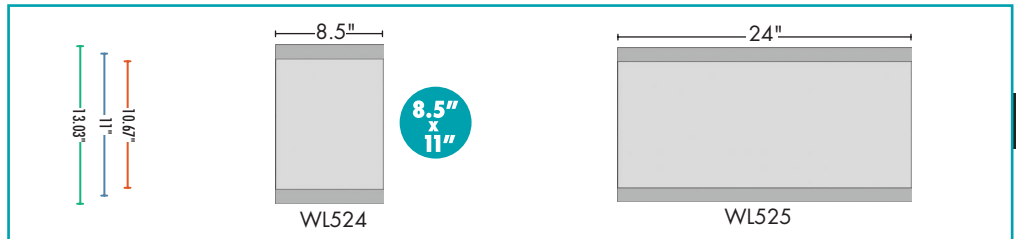
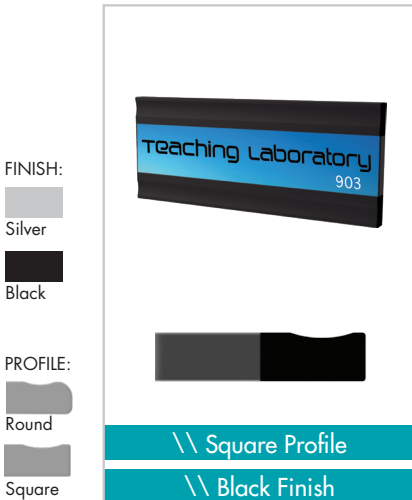

11

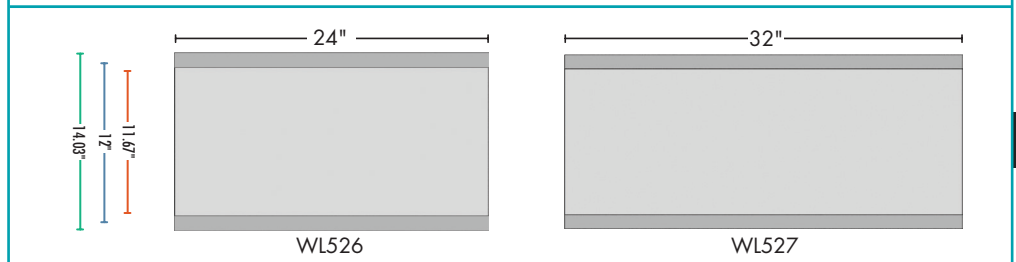

12



FINISH:



Silver



Black

PROFILE:



Round



Square

■ Frame Size ■ Graphic Dims ■ Visible Area PREFIX: Add "FLAT-" to each listed code

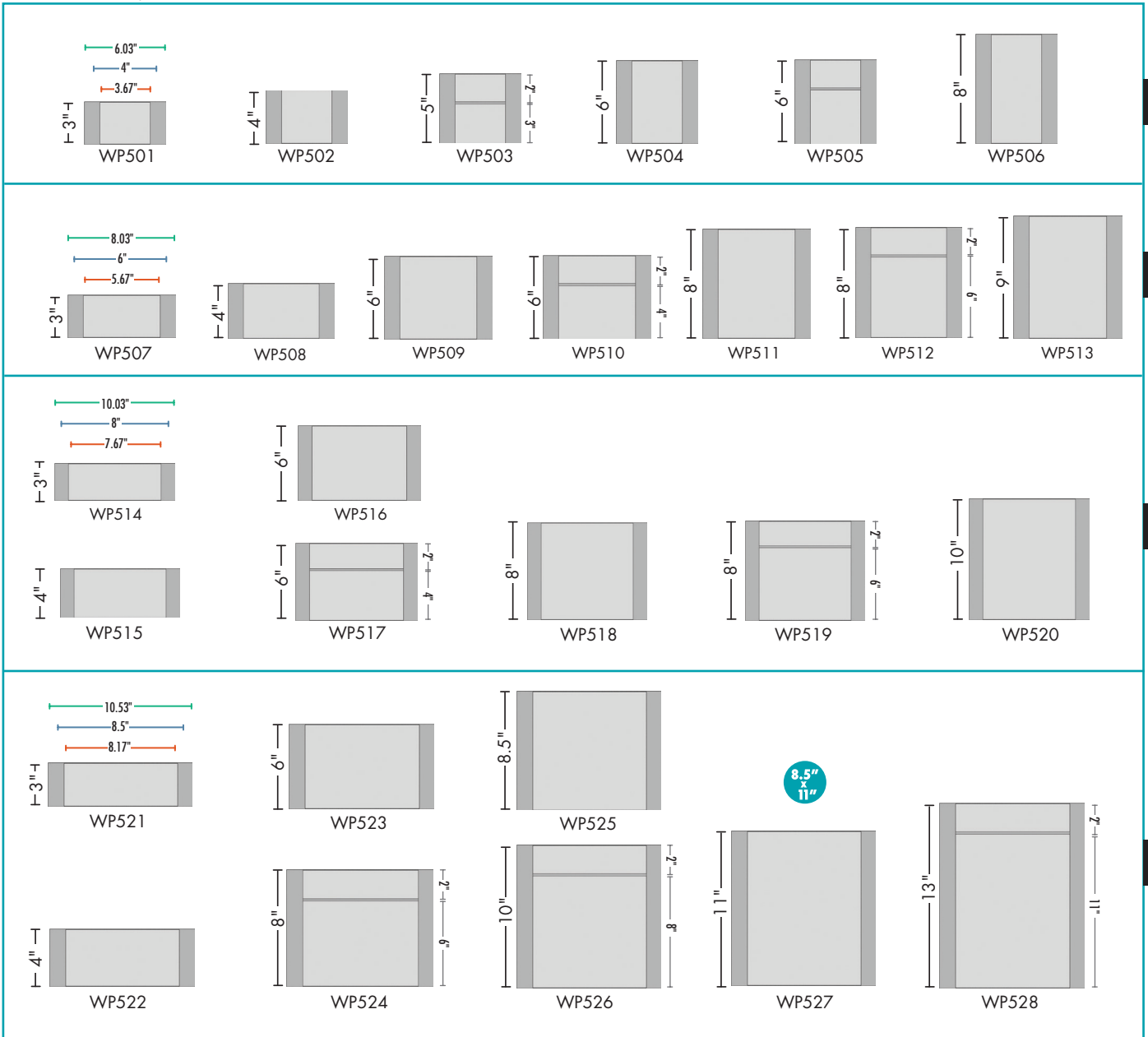

**LEFT & RIGHT  
WALL SIGNS**

■ Frame Size ■ Graphic Dims ■ Visible Area

PREFIX: Add "FLAT-" to each listed code

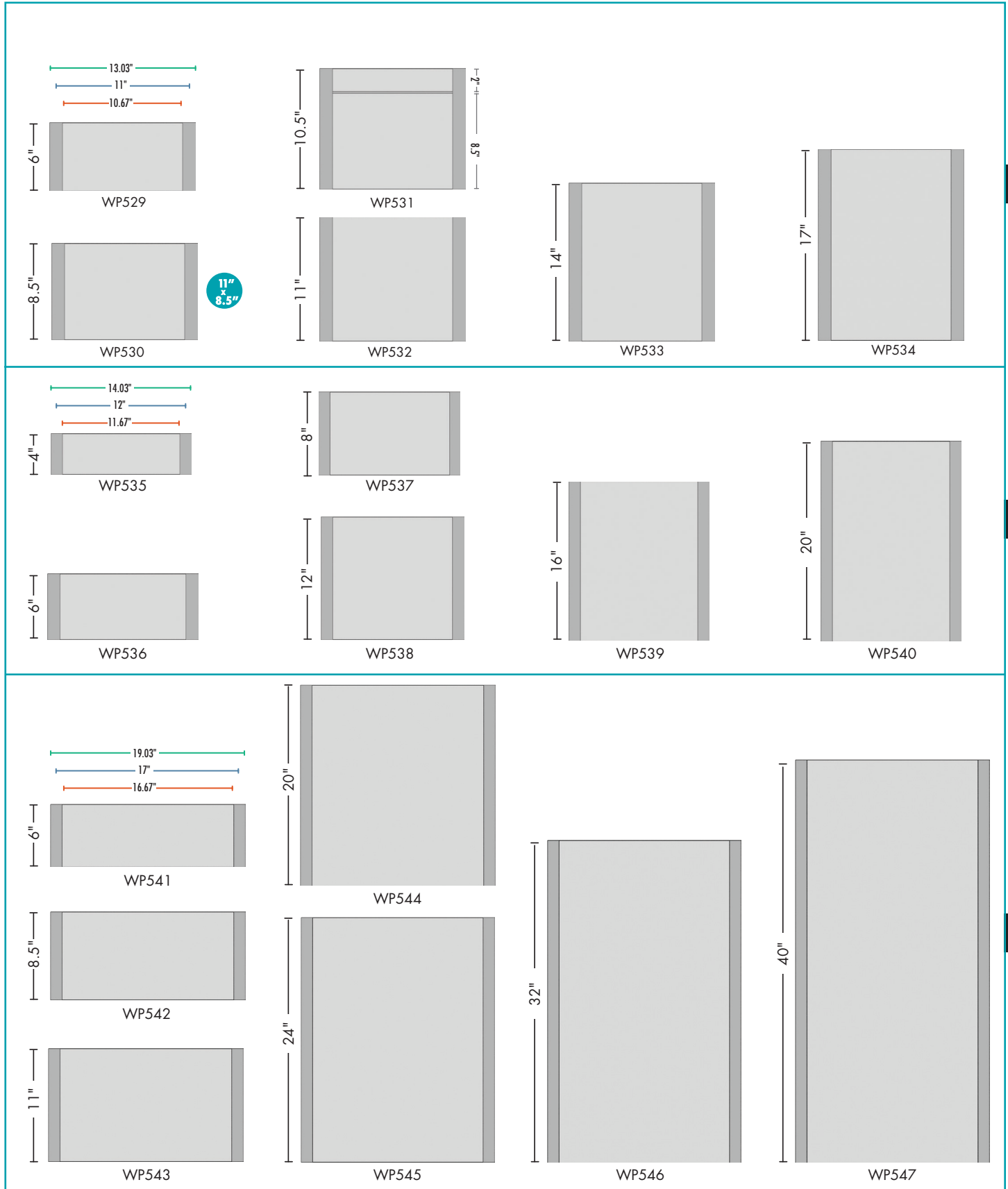

11

12

17

**LEFT & RIGHT  
WALL SIGNS**

■ Frame Size ■ Graphic Dims ■ Visible Area PREFIX: Add "FLAT-" to each listed code

20

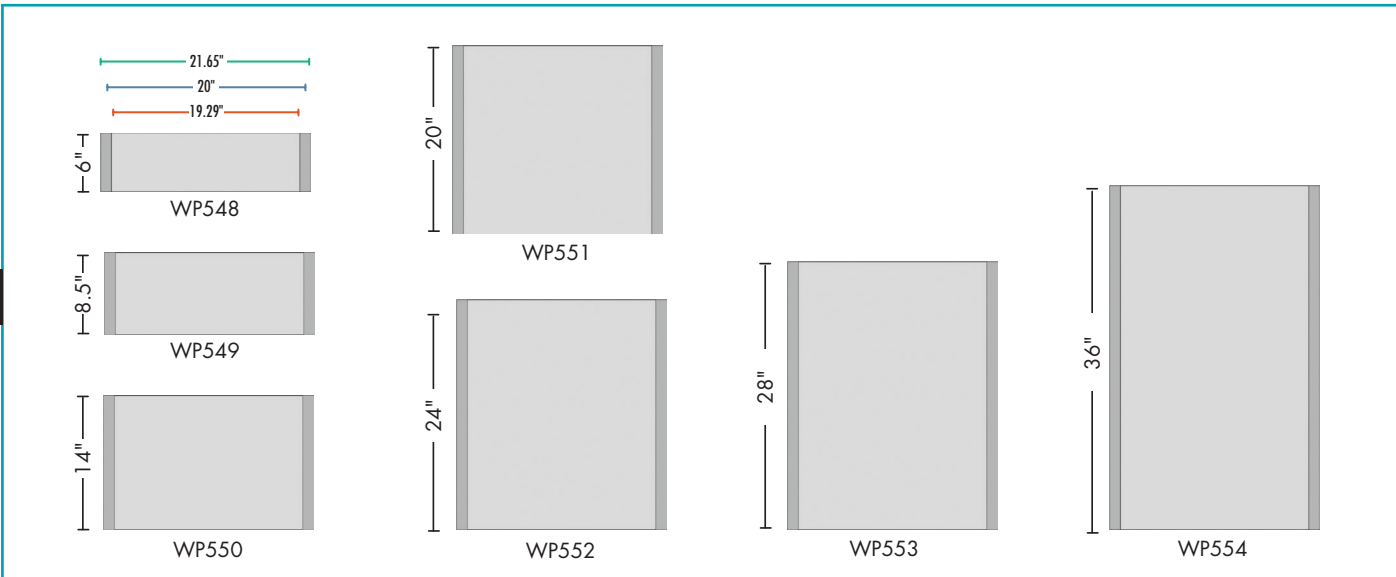

24

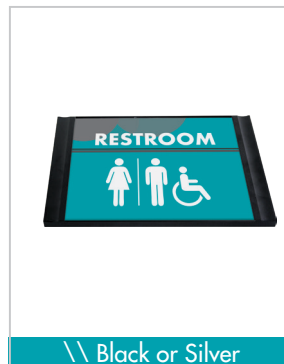
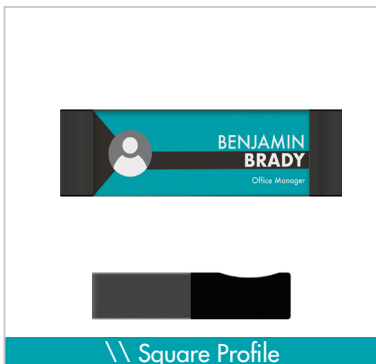
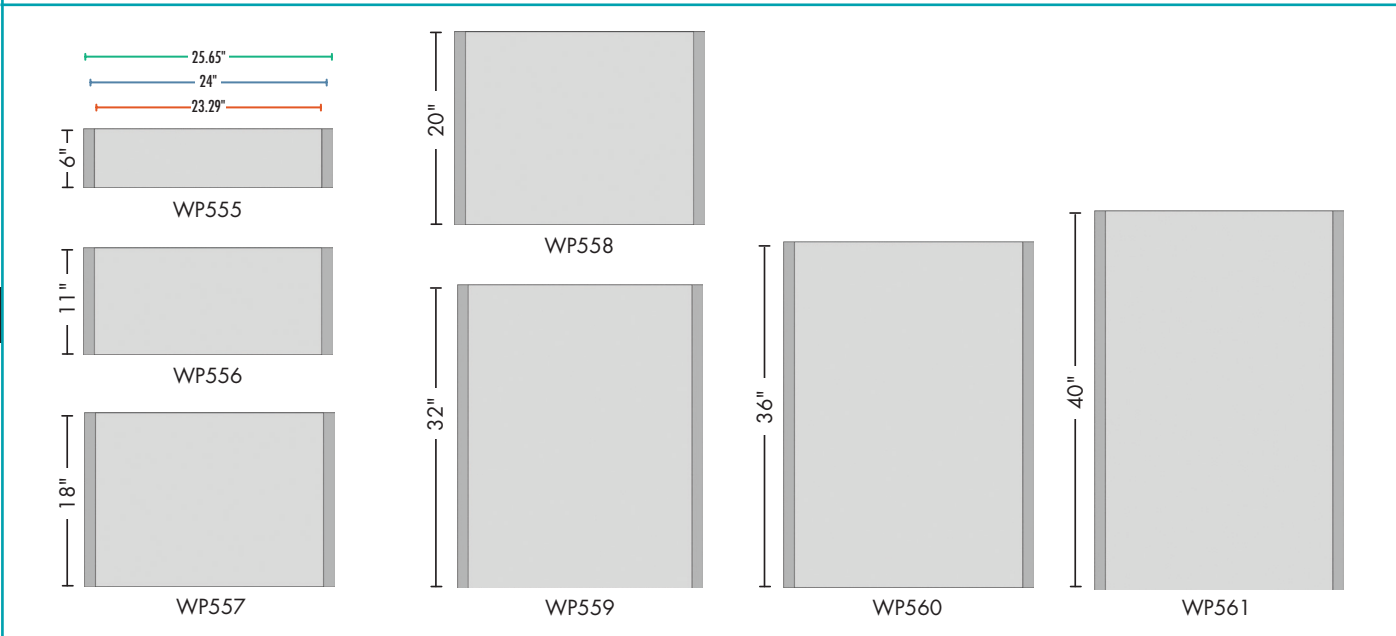

- FINISH:
- Silver
  - Black
- PROFILE:
- Round
  - Square





TOP & BOTTOM

PROJECTING

■ Frame Size ■ Graphic Dims ■ Visible Area

PREFIX: Add "FLAT-" to each listed code

4

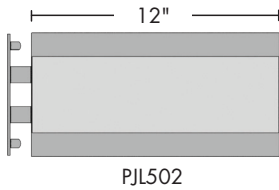
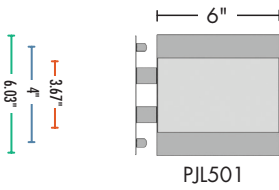

6

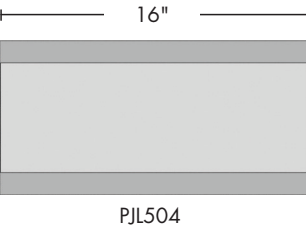
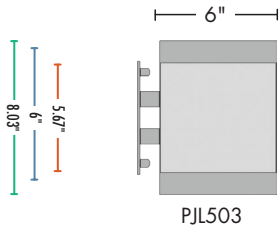

8

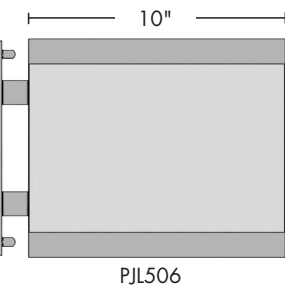
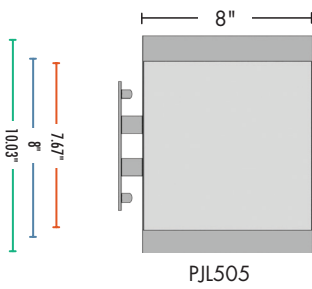

LETTER

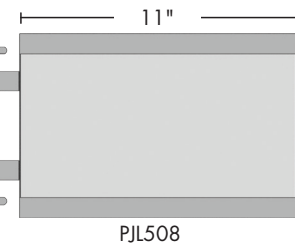
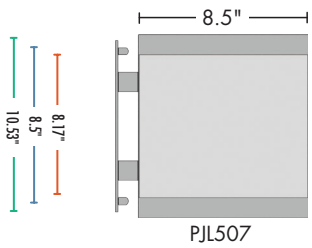

11

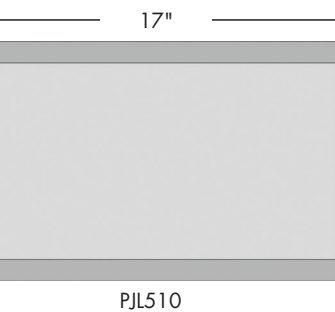
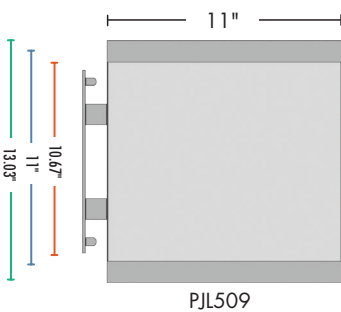

- \\ Double-sided flat projecting frames in landscape orientation
- \\ Frames located on top & bottom offered anodized in silver or black
- \\ Frames offered in choice of round or square-shaped
- \\ End caps match the frame color of choice
- \\ Inserts can be replaced
- \\ Comes with non-glare lens, fully assembled
- \\ Custom sizes available



FINISH:

- Silver
- Black

PROFILE:

- Round
- Square



■ Frame Size ■ Graphic Dims ■ Visible Area PREFIX: Add "FLAT-" to each listed code

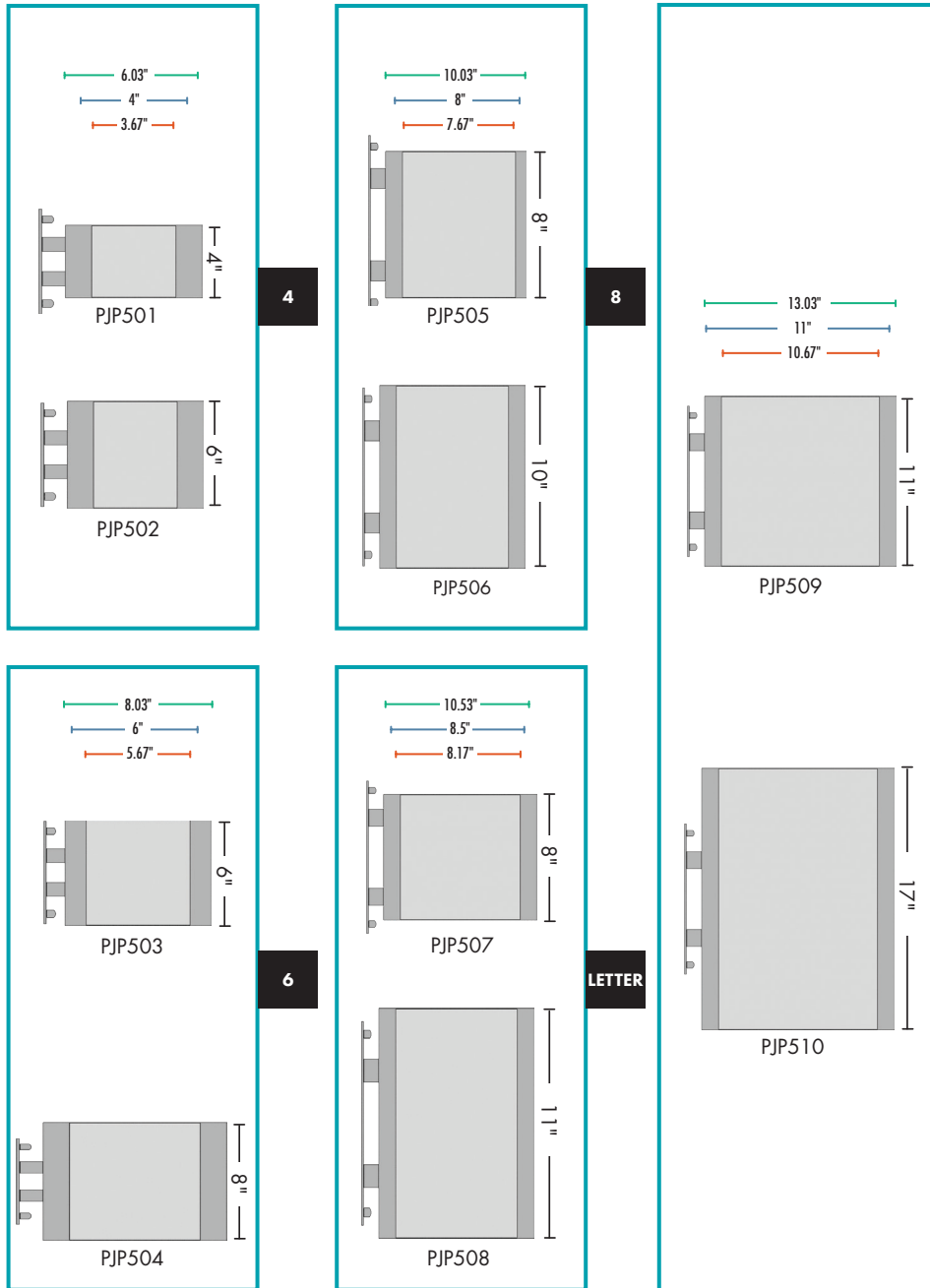

- \\ Double-sided flat projecting frames in portrait orientation
- \\ Frames located on left & right sides
- \\ Frame color choice of anodized silver or black
- \\ Frames offered in choice of round or square-shaped
- \\ End caps match the frame color of choice
- \\ Inserts can be replaced individually
- \\ Comes with non-glare lens, fully assembled
- \\ Custom sizes available

\\ Square Profile  
\\ Black Finish

**TOP & BOTTOM  
SUSPENDED**

■ Frame Size ■ Graphic Dims ■ Visible Area PREFIX: Add "FLAT-" to each listed code

<b>4</b>	<p>SUSP501</p>	<p>SUSP502</p>	<p>SUSP503</p>
<b>6</b>	<p>SUSP504</p>	<p>SUSP505</p>	<p>SUSP506</p>
<b>8</b>	<p>SUSP507</p>	<p>SUSP508</p>	<p>SUSP509</p>
<b>LETTER</b>	<p>SUSP510</p>	<p>SUSP511</p>	<p>SUSP512</p>
<b>11</b>	<p>SUSP513</p>	<p>SUSP514</p>	
<b>17</b>	<p>SUSP515</p>	<p>SUSP516</p>	<p>SUSP517</p>

- \\ Double-sided flat projecting frames in landscape orientation
- \\ Frames located on top & bottom offered in anodized silver or black
- \\ Frames offered in choice of round or square-shaped
- \\ End caps match the frame color of choice
- \\ Inserts can be replaced individually
- \\ Comes with non-glare lens, fully assembled
- \\ Custom sizes available

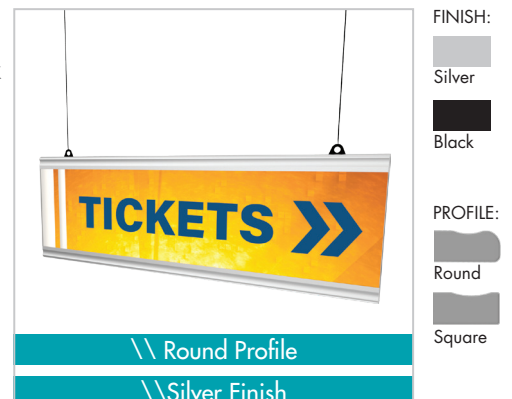

- \\ Triangular frame shape offered in choice of round or square-shaped
- \\ Frames located on the left & right sides
- \\ Configure the directory header to be placed as desired
- \\ Frame color choice of anodized silver or black
- \\ Inserts can be replaced individually
- \\ Custom sizes available

■ Frame Size ■ Graphic Dims ■ Visible Area

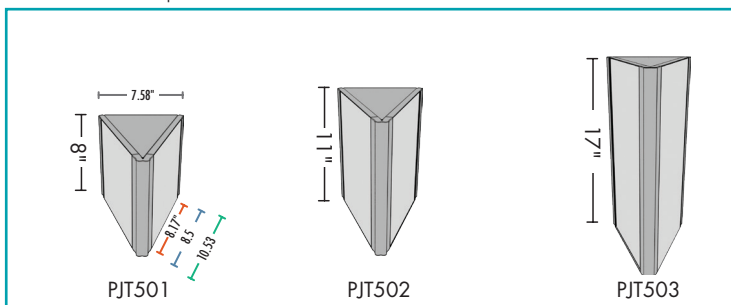

PREFIX: Add "FLAT-" to each listed code





## CURVED SYSTEM



- \\ Aluminum frame extrusions are offered from 4" to 48" wide, at varying heights
- \\ Frames are available in anodized silver or powder coated black
- \\ Plastic end caps are offered in gray or black
- \\ Frames come standard with a clear, non-glare lens
- \\ Tape mounting included, holes are an additional cost
- \\ Custom lengths available





								2.36" 2-1/8"	<b>60</b>			
										3.93" 3-3/4"	<b>100</b>	
										4.72" 4-7/8"	<b>120</b>	
										5.90" 5-3/4"	<b>150</b>	
										7.87" 7-3/4"	<b>200</b>	
									8.64" 8-17/32"	<b>LETTER</b>		
										11.19" 11-1/16"	<b>11</b>	
											12.19" 12-1/16"	<b>12</b>
										17" 17"	<b>17</b>	
										18.19" 17-15/16"	<b>18</b>	
										24" 24.0625"	<b>24</b>	



blue insert slides left & right



partition pins used to secure frame to fabric wall

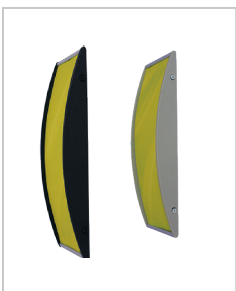

All length measurements apply to the extrusion only and exclude the end caps.



# LEFT-TO-RIGHT WALL SIGNS

- \\ High quality, left-to-right curved frames
- \\ Frames are available in anodized silver or powder coated black
- \\ Frames come standard with a clear, non-glare lens
- \\ Tape mounting included, holes are an additional cost
- \\ Frames are ADA-compatible
- \\ Custom lengths available

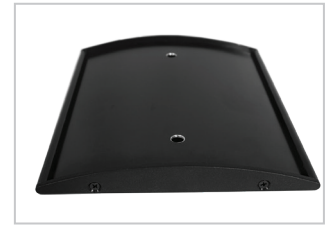
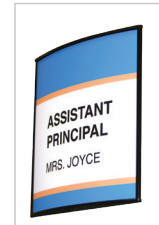
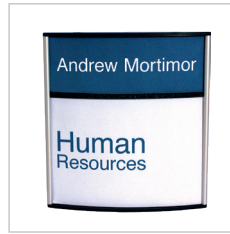

comes fully assembled



graphic dimension

frame dimension

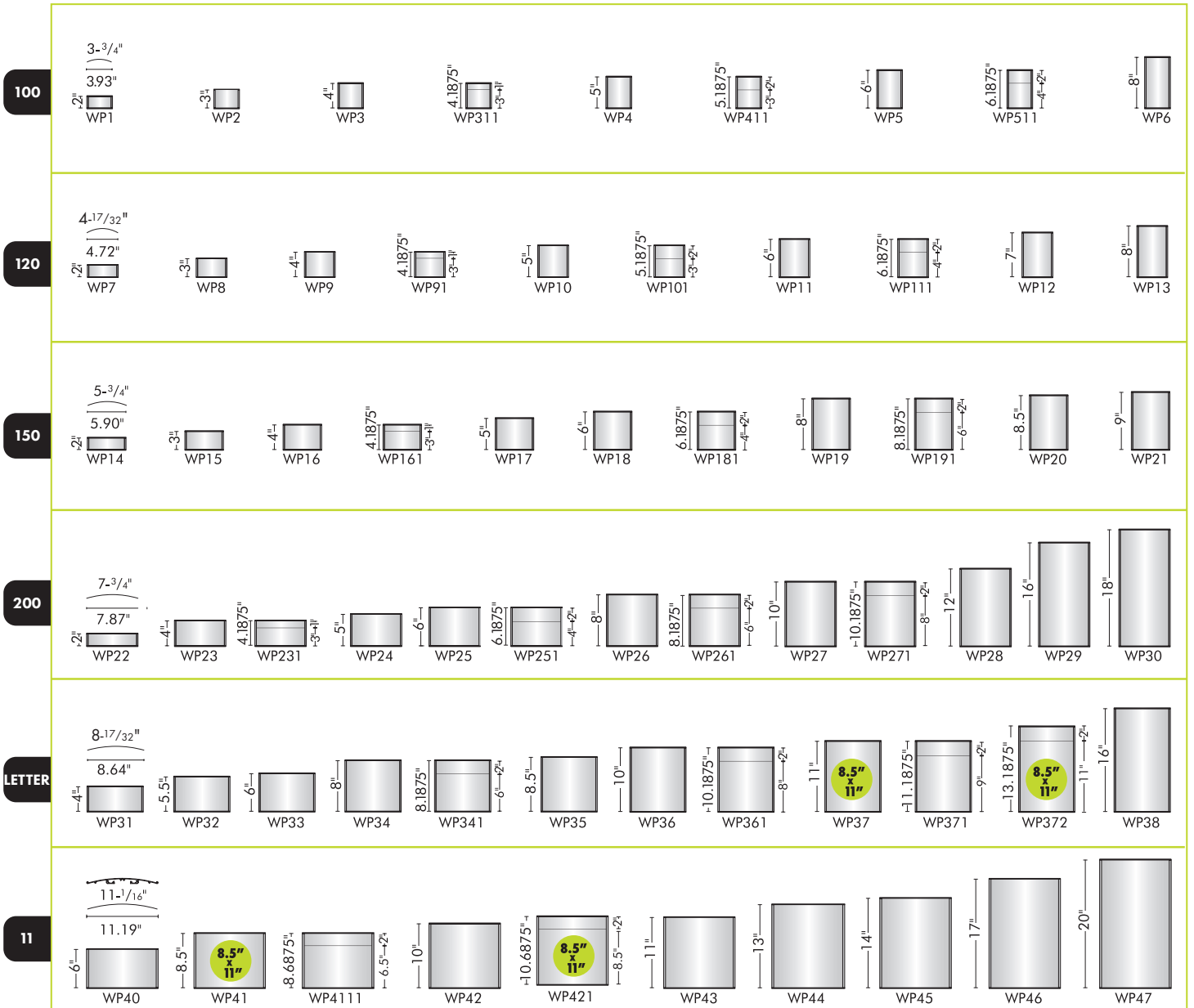

All length measurements apply to the extrusion only and exclude the end caps.



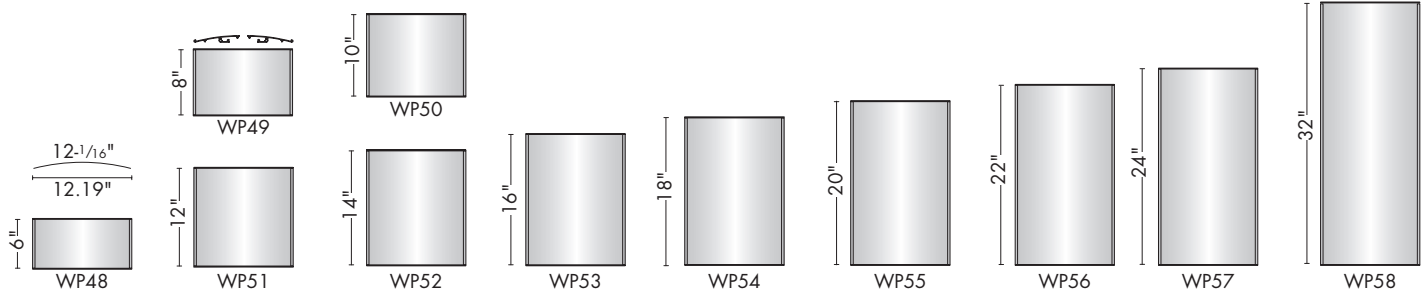

12

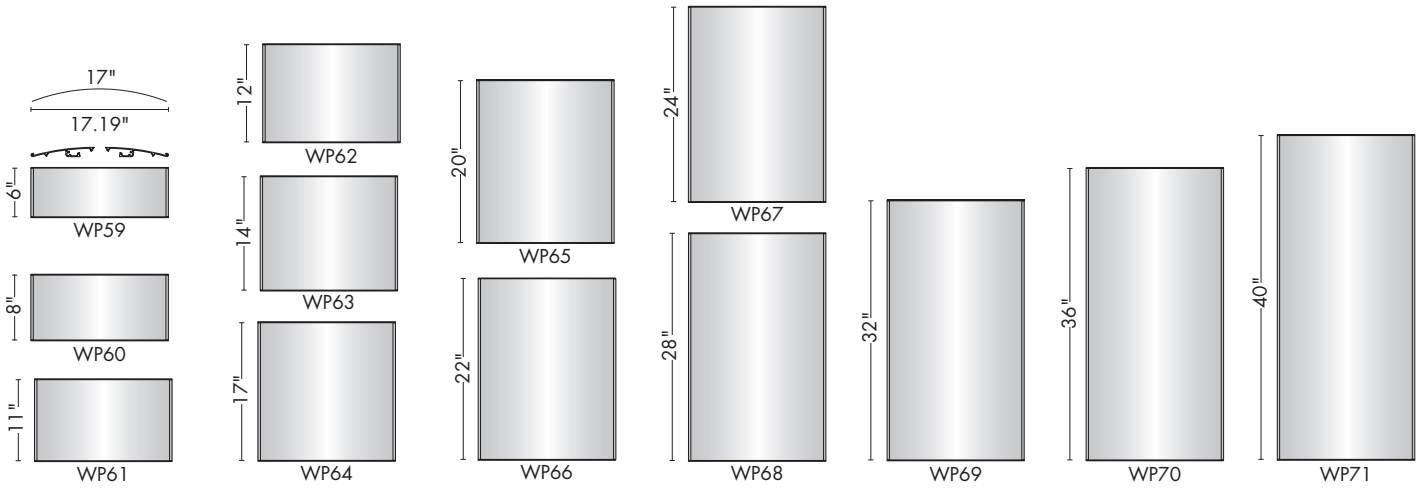

17

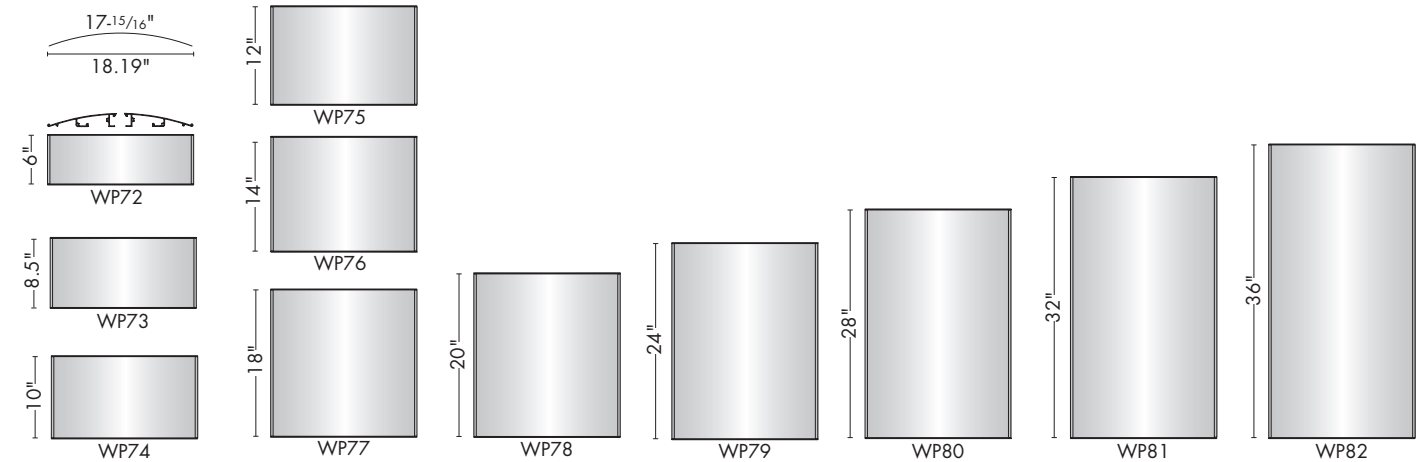

18

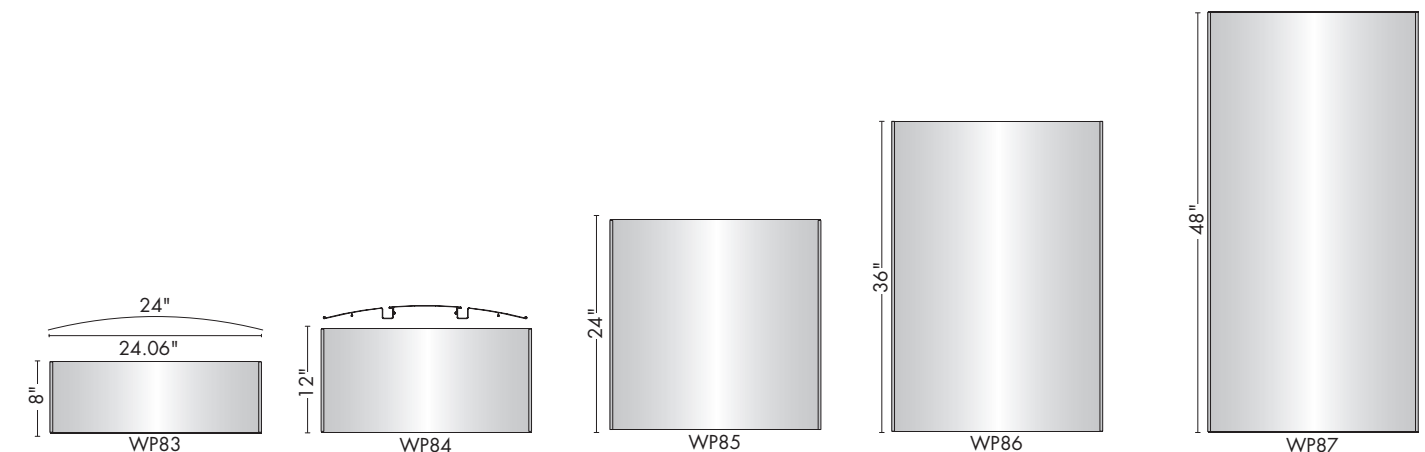

24

All length measurements apply to the extrusion only and exclude the end caps.

ADA lenses available for select wall frames only. Minimum of ten ADA lenses required per order.

**DIRP SERIES**  
**DIRECTORIES**

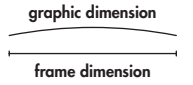

11

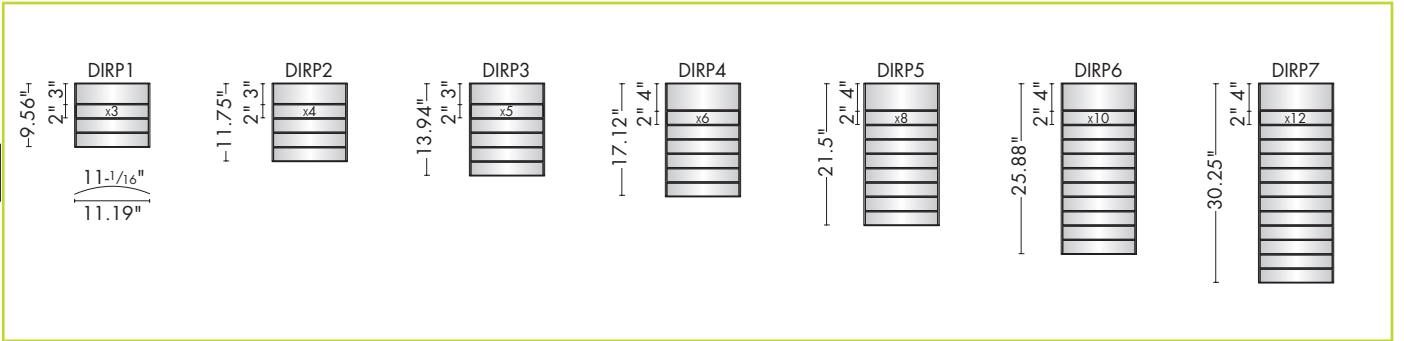

17

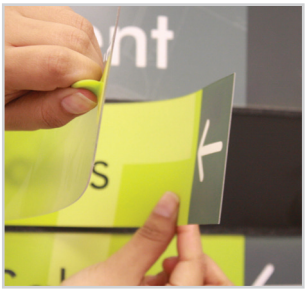
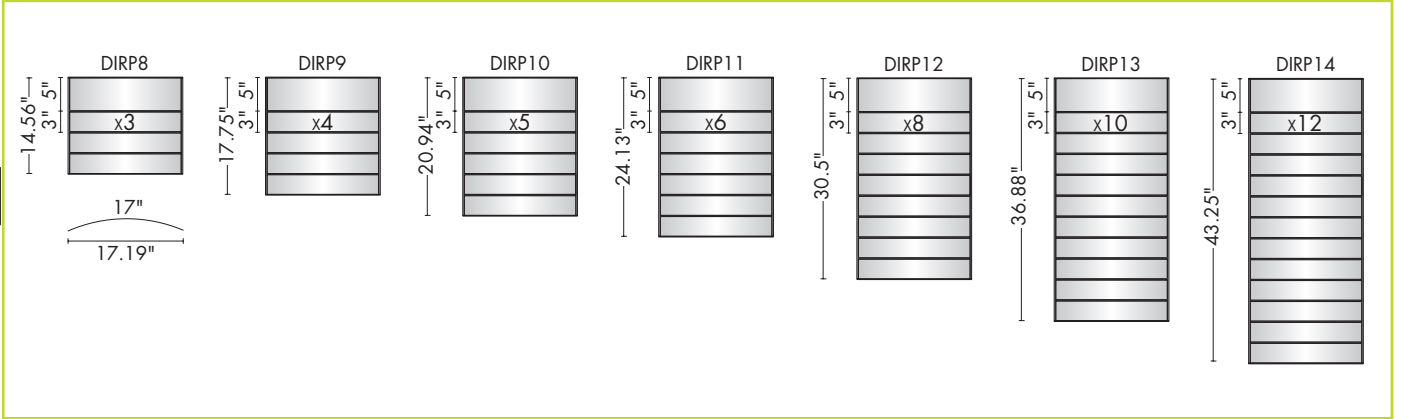

graphic is easily inserted before clear, non-glare lens

24

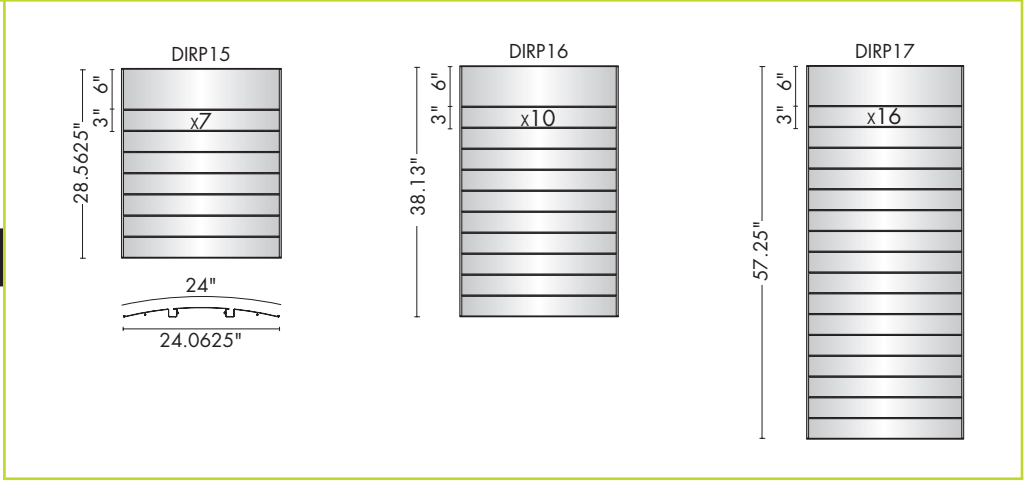

All length measurements apply to the extrusion only and exclude the end caps.

- \\ Dividing strips adhere to the frame and can be placed anywhere desired
- \\ End caps located on top & bottom
- \\ Inserts can be replaced individually
- \\ Custom frame combinations & lengths available



- \\ Combine multiple vertical frames with a top-to-bottom curve header
- \\ Vertical frames come with black dividing strips
- \\ Inserts can be replaced individually
- \\ Choice of black or gray end caps
- \\ Custom frame combinations & lengths available

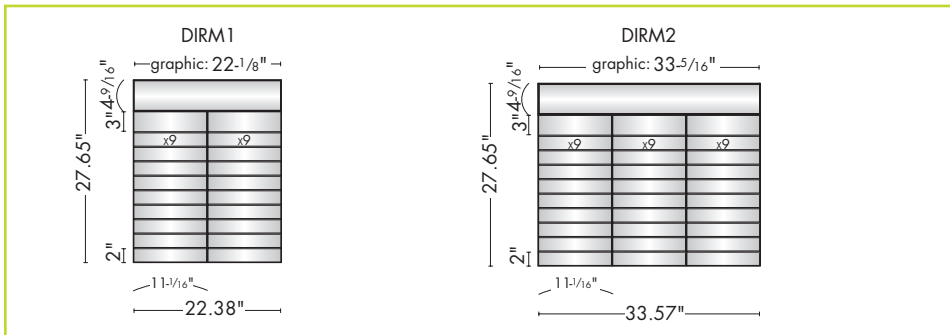

EAST WING LEVEL 1		
103	ADMINISTRATION	RESPIRATORY THERAPY 112
104	ADMISSIONS/CASHIER	REHABILITATION OFFICE 113
105	PATIENT RELATIONS OFFICE	PURCHASING/RECEIVING 114
106	PHARMACY	FAMILY WAITING ROOM 115
107	RADIOLOGY	ENVIRONMENTAL OFFICE 116
108	PHYSICAL THERAPY	SOCIAL SERVICES 117
109	ULTRASONOGRAPHY	GIFT SHOP 118
110	PATHOLOGY	CAFE 119
111	CT SCAN	HUMAN RESOURCES 120

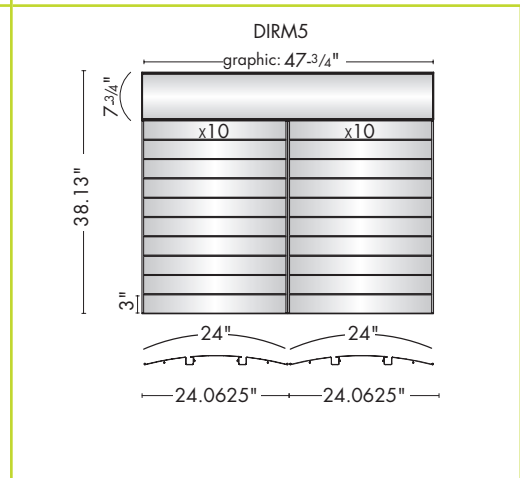
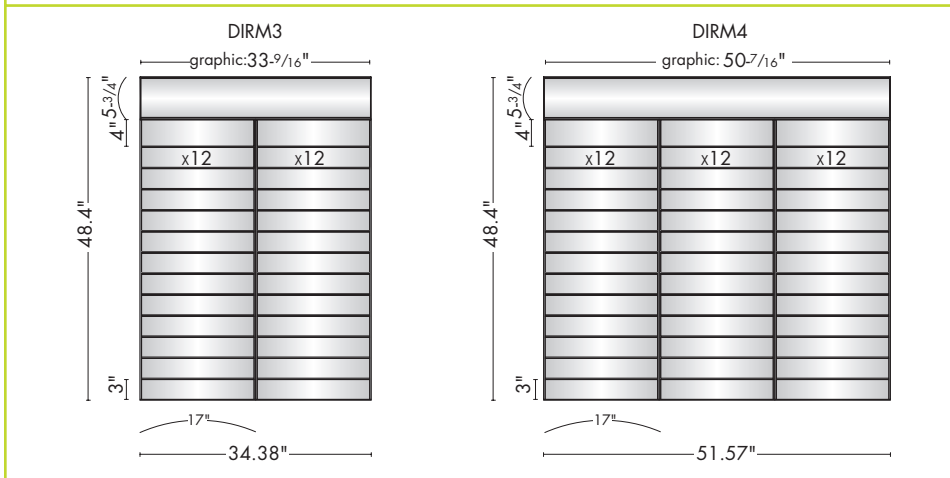

All length measurements apply to the extrusion only and exclude the end caps.

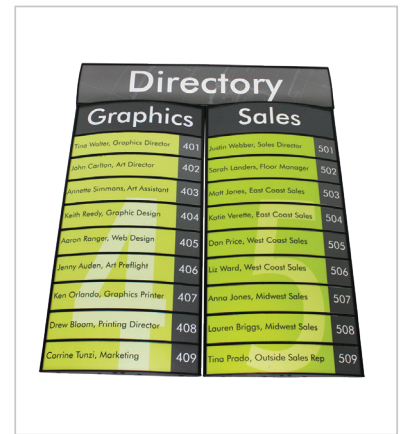
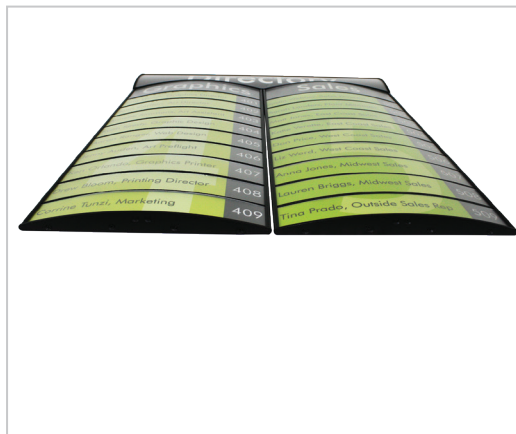

the non-glare lens is easily taken off with the suction cup for individual graphic replacement

**DIRL SERIES**

**DIRECTORIES**

- \\ Consists of multiple top-to-bottom curved frames combined
- \\ End caps on left & right sides
- \\ Comes as separate frames to mount to the wall individually
- \\ Choice of black or gray end caps
- \\ Custom frame combinations & lengths available

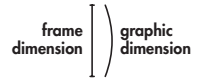

100	 DIRL1	 DIRL2	 DIRL3	
200	 DIRL4	 DIRL5	 DIRL6	
LETTER	 DIRL7	 DIRL8	 DIRL9	

All length measurements apply to the extrusion only and exclude the end caps.

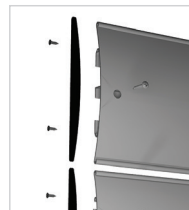
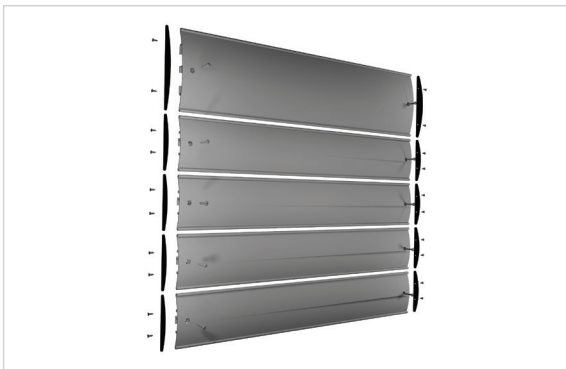

each frame allows for unique insert, available in custom widths up to 8'



the non-glare lens is easily taken off with the suction cup for individual graphic replacement



“This project was a great success. There is a sign type for every room and wayfinding location, and it was easy to customize and incorporate the signage into the entire design concept of the facility.”

photos courtesy of Fastsigns Lewiston

Tri-State Memorial Hospital

## Signage Challenge

Tri-State Memorial Hospital was in need of a variable and consistent wayfinding and room identification system throughout the facility. The sign solution needed to offer a variety of functions, while remaining easy-to-read to assist doctors, patients and visitors in navigating the facility to different wings and specialty clinics.

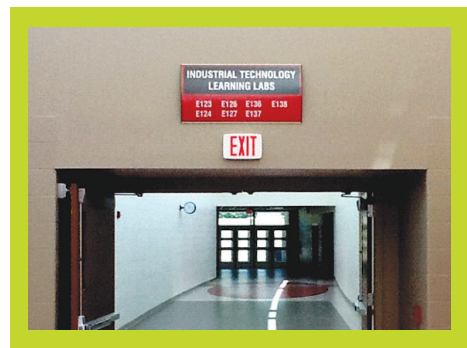

photos courtesy of Signs Now #74

## Signage Challenge

North Gibson School Corporation was in need of interior wayfinding signage for their high school to guide students, staff, and visitors to the right rooms and destinations.

“The outcome is effective and aesthetically pleasing to everyone who visits. The signage blends well. It directly guides visitors, students and staff to their intended destinations.”



**PJL**

**PROJECTING**

- \\ Double-sided, comes in landscape or portrait positions
- \\ End caps on left & right sides
- \\ Anodized silver or powder coated black frames
- \\ Choice of black or gray end caps
- \\ Comes with clear non-glare lens
- \\ Custom lengths available

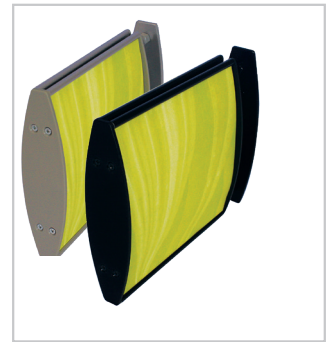

graphic dimension | frame dimension

100



150



200

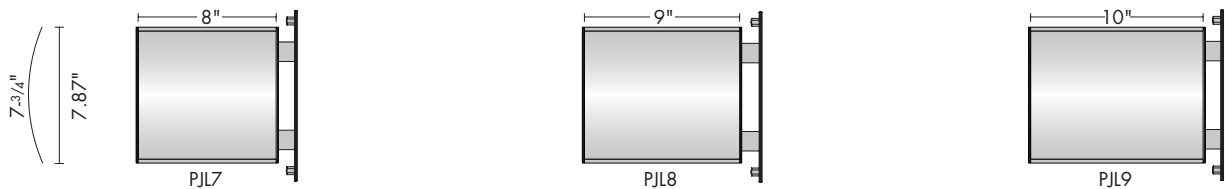

LETTER

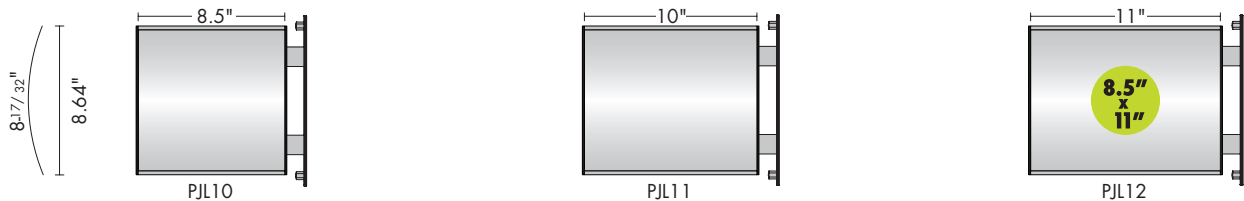

11

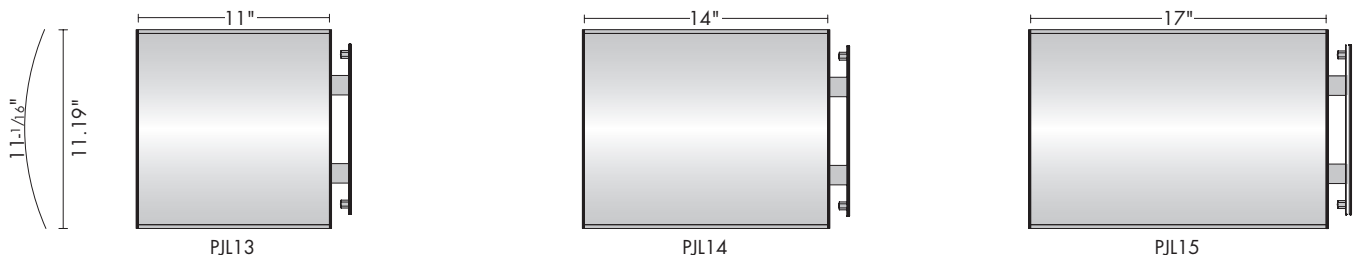

All length measurements apply to the extrusion only and exclude the end caps.



- \\ Flat, double-sided, projecting signs
- \\ Idea for cut vinyl applications
- \\ Sliver finish with black plastic end caps
- \\ Comes fully assembled
- \\ Custom lengths available

**PJF**  
**PROJECTING**

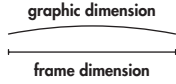

5" 4" PJF1

7.5" 4" PJF2

10" 4" PJF3

12" 4" PJF4

14" 4" PJF5

16" 4" PJF6

3-3/4" 3.93" graphic dimension

4.75" PJP1

5.5" PJP2

100

7-3/4" 7.87" graphic dimension

8" PJP5

10" PJP6

200

5-3/4" 5.90" graphic dimension

6" PJP3

6.75" PJP4

150

8-17/32" 8.64" graphic dimension

8" PJP7

11" PJP8

8.5" x 11"

LETTER

11-1/16" 11.19" graphic dimension

11" PJP9

14" PJP10

17" PJP11

11

All length measurements apply to the extrusion only and exclude the end caps.

TOP-TO-BOTTOM

SUSPENDED

- \\ Suspended signs combine back-to-back extrusions
- \\ Ideal for cut vinyl applications
- \\ Choice of black or gray end caps
- \\ Comes with clear non-glare lens, fully assembled
- \\ Custom lengths available



frame dimension | graphic dimension

60	<p>2-1/8" ( ) 2.36"</p>	<p>SUSP2 16"</p>	<p>SUSP3 20"</p>	<p>SUSP4 24"</p>	
100	<p>3-3/4" ( ) 3.93"</p>	<p>SUSP6 24"</p>	<p>SUSP7 28"</p>	<p>SUSP8 32"</p>	
120	<p>4-17/32" ( ) 4.72"</p>	<p>SUSP10 26"</p>	<p>SUSP11 30"</p>	<p>SUSP12 34"</p>	
150	<p>5-3/4" ( ) 5.9"</p>	<p>SUSP14 28"</p>	<p>SUSP15 33"</p>	<p>SUSP16 38"</p>	
200	<p>7-3/4" ( ) 7.87"</p>	<p>SUSP18 26"</p>	<p>SUSP19 32"</p>	<p>SUSP20 38"</p>	
LETTER	<p>8-17/32" ( ) 8.64"</p>	<p>SUSP22 20"</p>	<p>SUSP23 25"</p>	<p>SUSP24 40"</p>	
11	<p>11-1/16" ( ) 11.19"</p>	<p>SUSP242 17"</p>	<p>SUSP243 24"</p>	<p>SUSP244 36"</p>	
17	<p>17" ( ) 17.19"</p>	<p>SUSP246 24"</p>	<p>SUSP247 28"</p>	<p>SUSP248 36"</p>	<p>SUSP249 48"</p>

All length measurements apply to the extrusion only and exclude the end caps.

<p>SUSP25 16" 2.1/8"</p>	<p>SUSP26 24" 2.36"</p>	<p>SUSP27 24" 2.1/8"</p>	<p>60</p> <p>60</p> <p>60</p>
<p>SUSP31 26" 4.72"</p>	<p>SUSP32 30" 4.17/32"</p>	<p>SUSP33 34" 4.17/32"</p>	<p>120</p> <p>120</p>
<p>SUSP34 28" 5.90"</p>	<p>SUSP35 34" 5.3/4"</p>	<p>SUSP36 38" 5.90"</p>	<p>150</p> <p>150</p>
<p>SUSP40 11" 8.5" x 11" 8.5" x 11"</p>	<p>SUSP41 26" 8.64"</p>	<p>SUSP42 40" 8.17/32"</p>	<p>LETTER</p> <p>LETTER</p>
<p>SUSP46 20" 8.64"</p>	<p>SUSP47 25" 8.17/32"</p>	<p>SUSP48 30" 4.72"</p>	<p>LETTER</p> <p>120</p> <p>120</p>

All length measurements apply to the extrusion only and exclude the end caps.



24" left-to-right curve



17" left-to-right curve

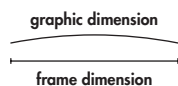

**LEFT-TO-RIGHT**

**SUSPENDED**

- \\ Available with a left-to-right curve orientation in both 24" and 17" widths
- \\ Combined with the height of your choice
- \\ Silver or black curved aluminum face, choice of black or grey end caps
- \\ Comes complete with a clear, non-glare lens
- \\ Comes fully assembled

**PJT**

**TRIANGULAR**

- \\ Triangular frames offered in two silver or black aluminum curved faces
- \\ Black powder-coated steel end caps
- \\ Mounting plates come standard with keyholes and round holes
- \\ Available in eight standard heights
- \\ Custom lengths available

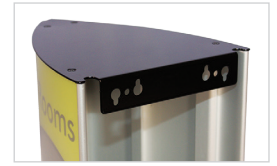
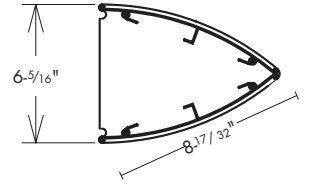

 PJT1	 PJT2	 PJT3	 PJT4	 PJT5	 PJT6	 PJT7	 PJT8
----------	----------	----------	----------	----------	----------	----------	----------

**TR**

**TRIANGULAR**

- \\ The triangular aluminum extruded body with impact-modified molded plastic end caps
- \\ Allows for wall or ceiling mount
- \\ Visible from two directions
- \\ Custom lengths available

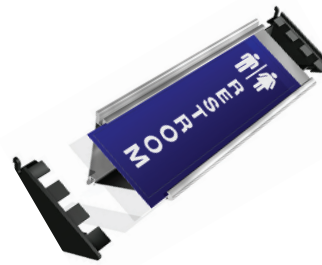

 TR1	 TR2	 TR3	 TR4	 TR5	 TR6	 TR7
---------	---------	---------	---------	---------	---------	---------

All length measurements apply to the extrusion only and exclude the end caps.



DIRECTORY	
FIRST FLOOR	SECOND FLOOR
Hawkeye Real Estate 101	Midwest Loan Office 201
Brookfield Properties 102	Decor Jewelry Repair 202
Johnson Consultants 103	General Import Store 203
Charles Whitney Inc. 104	Dravis Tailoring 204
Cohesion Tax Services 105	Illinois Medical Supply 205
Ward Financial 106	Barrington Properties 206



## SNAP-EDGE

### TRAPPA

- \\ Silver or black anodized finish with precision mitered corners
- \\ Snaps open for quick and easy graphic changes
- \\ No tools required
- \\ Aluminum extrusions mounted to a high-impact polystyrene backer
- \\ Comes with clear non-glare lens, mounting hardware
- \\ Protective sheet material: PVC

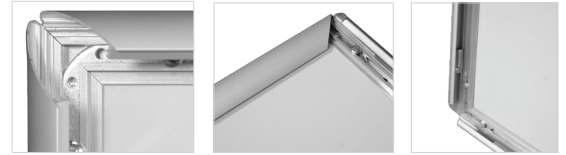

Dimensions below refer to size of printed graphic only.

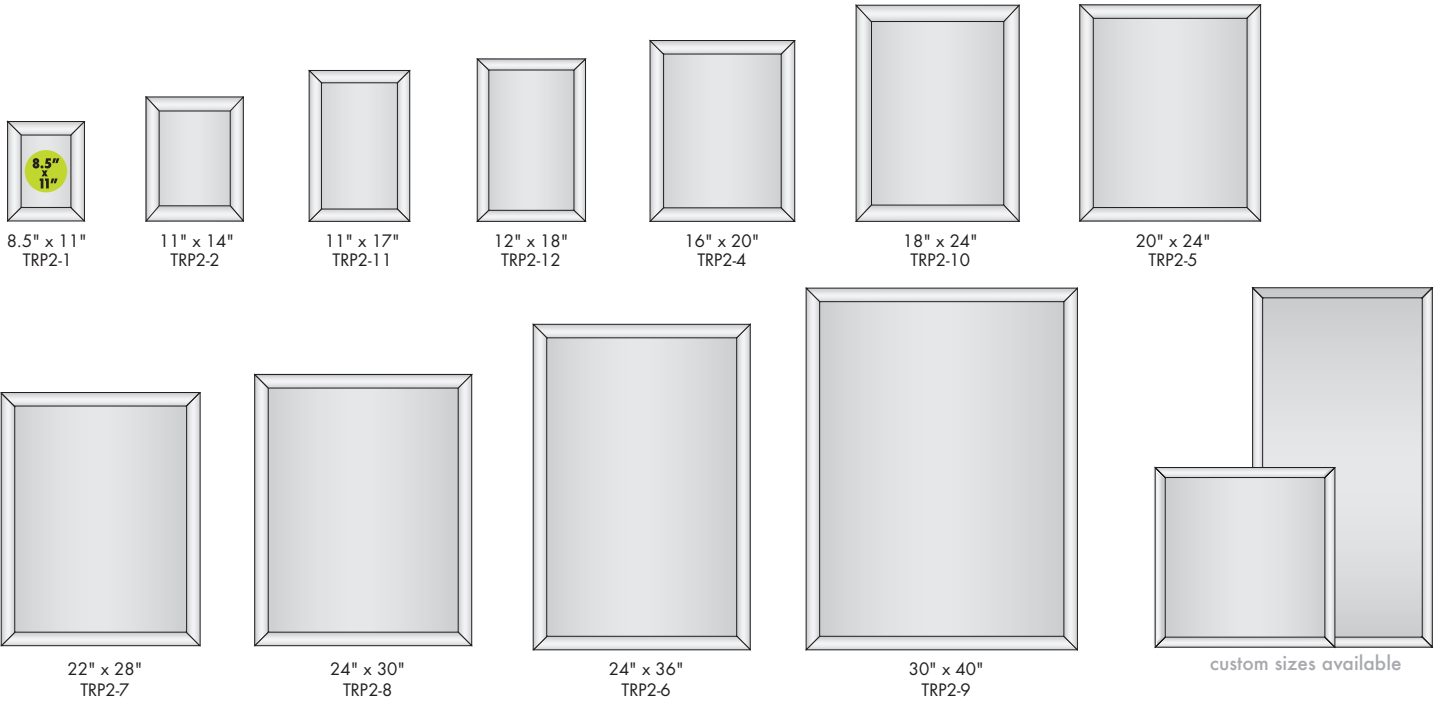

## SNAP-EDGE

### TRP CUSTOM

- \\ Trappa Poster Frame offers a simple, elegant snap rail solution for your custom-sized needs.
- \\ Combines two custom-length spring loaded snap rails with a backer
- \\ Comes with clear non-glare lens
- \\ Allows you to mount to a wall just by inserting the poster and snapping the edges shut
- \\ Rails, backer and lens are cut to size, depending on your graphic dimensions and desired rail length

#### SUGGESTED POPULAR SIZES

8.5" x 11"

11" x 17"

20" x 24"

22" x 28"

24" x 36"

24" x 48"

30" x 40"

36" x 52"





**SNAP-LED**

**TRAPPA**

- \\ 1" thick
- \\ 50,000 hr bulb life
- \\ Evenly distributed light
- \\ Snap frame allows easy graphic changes
- \\ Wall mounting hardware
- \\ Power supply with 78" cord
- \\ One year warranty

frame snaps open from the front



light box cord connects to wall adapter, illuminating the frame

CODE	SIZE
LED-SNAP-04	30"w x 40"h
LED-SNAP-05	36"w x 48"h



also available as hanging signs with our suspending clips



LED diffuser panel ensures even light distribution and brightness



**POSTER SNAPPER**

**TRAPPA**

- \\ Creates a clean, simple, elegant look
- \\ Hanging clips feature a top opening for clear nylon line mount as well as a recessed pocket for S-hook suspension
- \\ Adjustable hanging clips
- \\ Rails snap open and shut for quick graphic changes
- \\ Comes in four different standard widths: 24", 30", 36" and 48"
- \\ Custom-cut width available up to 60"

hanging options:

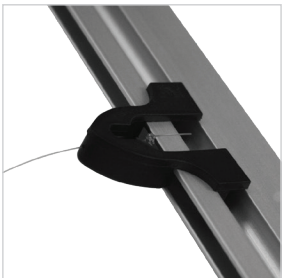

nylon line



S-hook



snap graphic rail for easy change-out

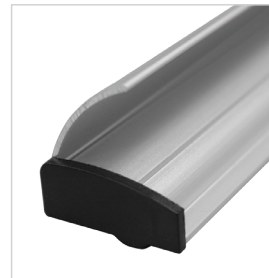

snap rail

**PJ-SNAP**

**PROJECTING**

- \\ Available in a wide range of sizes in black or silver
- \\ Double-sided projecting snap frames come with clear non-glare lenses
- \\ Fully assembled
- \\ Spring-loaded edges allows quick and easy graphic changes

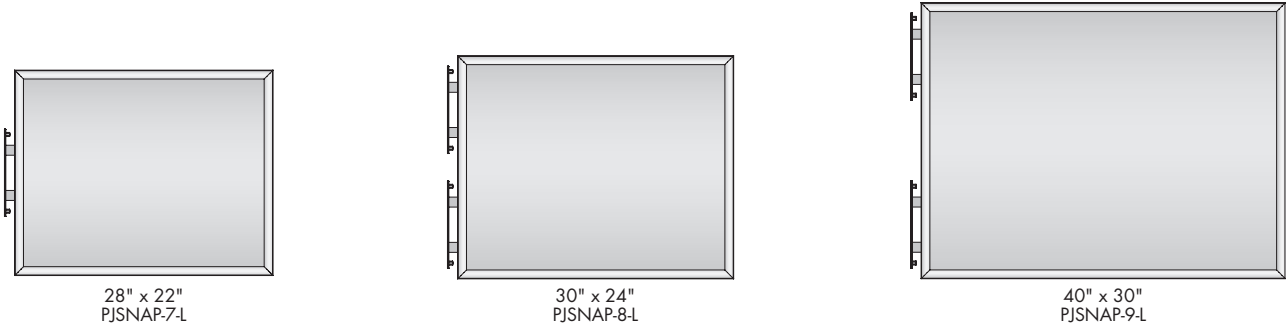
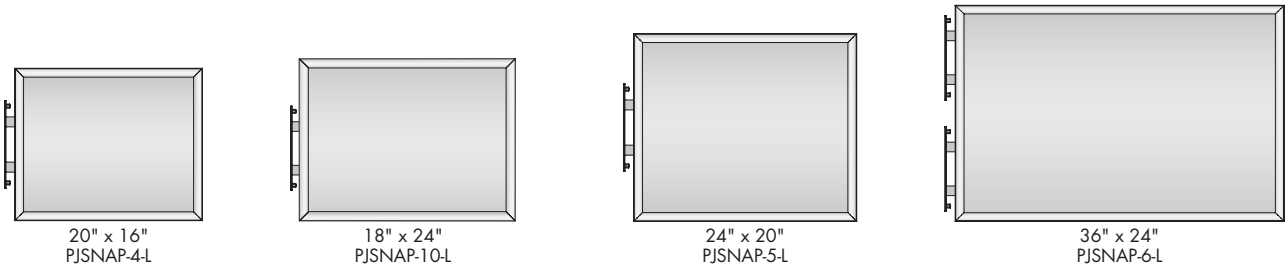
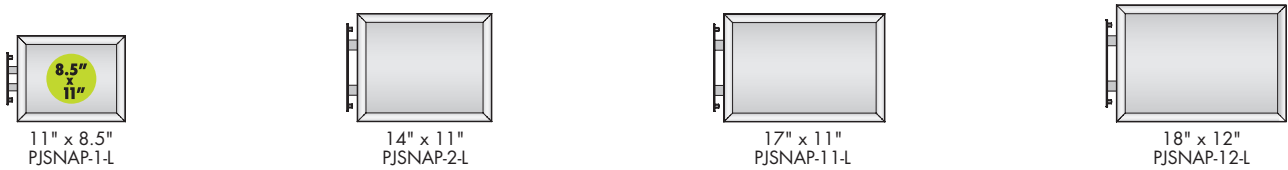
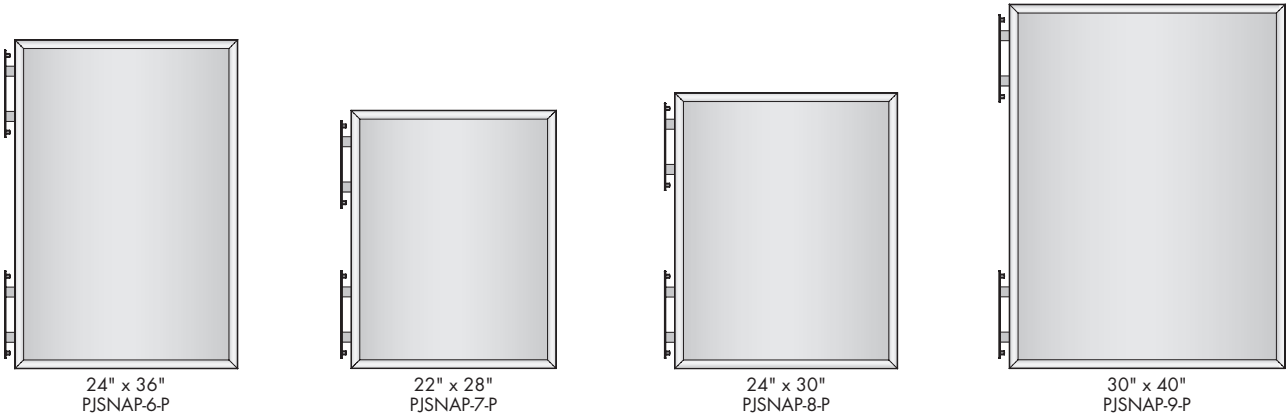
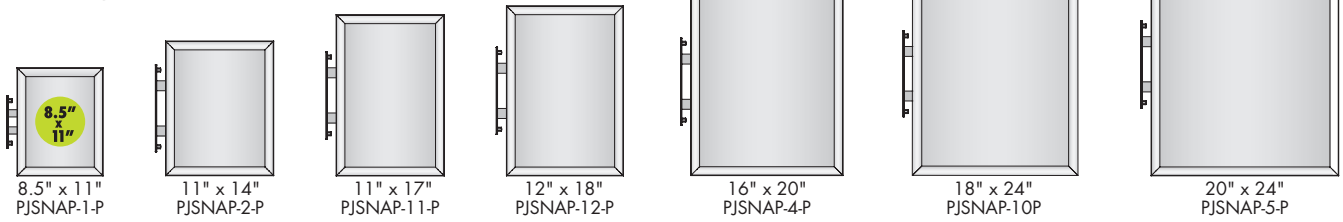
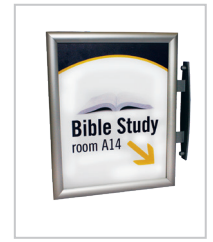

**SUSP-SNAP**

**SUSPENDED**



- \\ Available in a wide range of sizes in black or silver
- \\ Double-sided projecting snap frames come with clear non-glare lenses
- \\ Fully assembled



8.5" x 11"  
SUSPSNAP-1-P

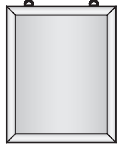

11" x 14"  
SUSPSNAP-2-P

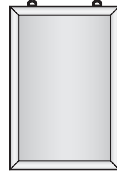

11" x 17"  
SUSPSNAP-11-P

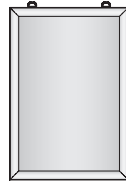

12" x 18"  
SUSPSNAP-12-P

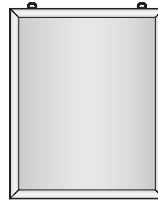

16" x 20"  
SUSPSNAP-4-P



18" x 24"  
SUSPSNAP-10-P

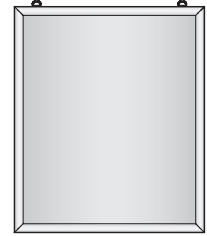

20" x 24"  
SUSPSNAP-5-P



24" x 36"  
SUSPSNAP-6-P

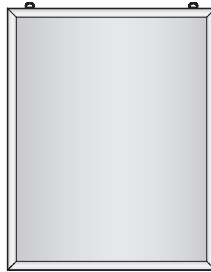

22" x 28"  
SUSPSNAP-7-P

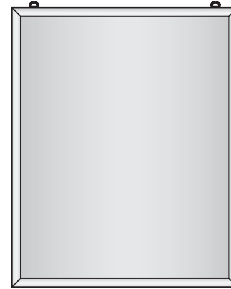

24" x 30"  
SUSPSNAP-8-P

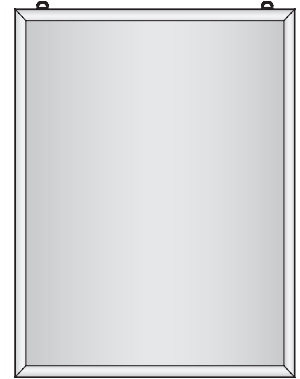

30" x 40"  
SUSPSNAP-9-P

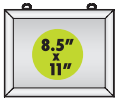

11" x 8.5"  
SUSPSNAP-1-L

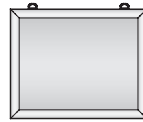

14" x 11"  
SUSPSNAP-2-L



17" x 11"  
SUSPSNAP-11-L

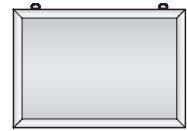

18" x 12"  
SUSPSNAP-12-L



20" x 16"  
SUSPSNAP-4-L



18" x 24"  
SUSPSNAP-10-L

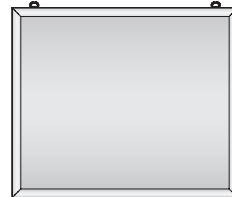

24" x 20"  
SUSPSNAP-5-L

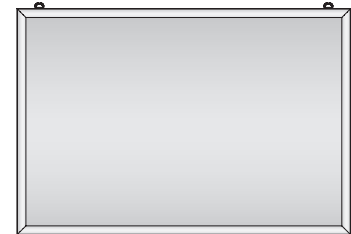

36" x 24"  
SUSPSNAP-6-L



28" x 22"  
SUSPSNAP-7-L

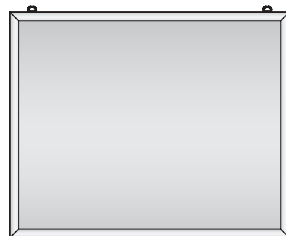

30" x 24"  
SUSPSNAP-8-L

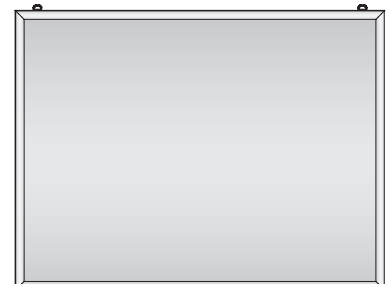

40" x 30"  
SUSPSNAP-9-L

CASE STUDY

WAYFINDING

## Wayfinding Signage Case Study

Laurel Toyota

“The results were fantastic! The professional staff of graphic designers and installers did a perfect job in all aspects of the project.”

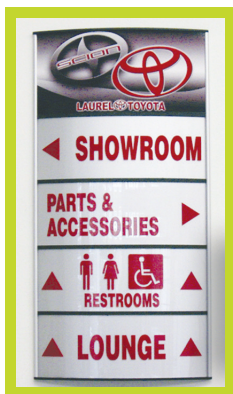

photos courtesy of Minahan Signs

### Signage Challenge

Laurel Toyota was in need of directional and wayfinding signage to help clients feel welcome and comfortable navigating through the facility. Toyota was looking for an affordable solution, provided by a local contact they could constantly be in touch with.

## Wayfinding Sign Solutions: Ideal for Churches, Hospitals and Schools

Wayfinding sign solutions are ideal to help visitors and staff of churches, hospitals, schools and more find their way and easily navigate the facility.





**DISPLAYS**

**PYLONS**

**DISPLAYS**

**INFO CENTERS**

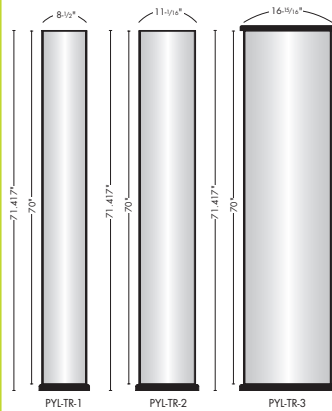
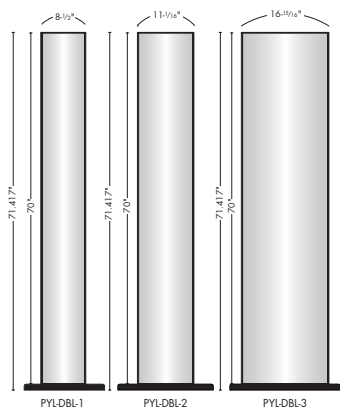

variable frame size options  
add versatility

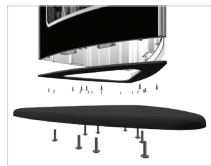
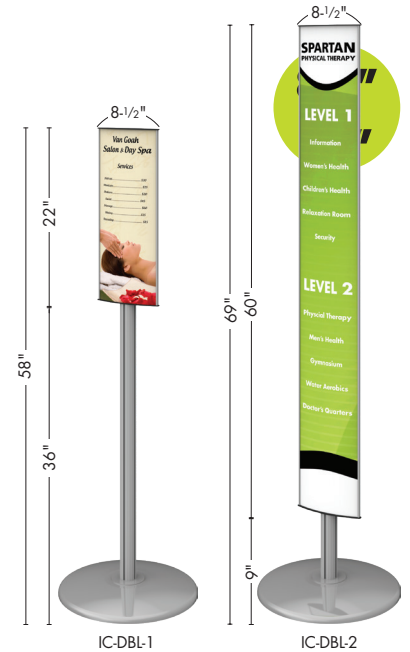

top view



top view

**PYL-DBL Series**

**PYL-DBL**

- \ \ Double-sided standing pylon display
- \ \ Choice of silver or black frames/extrusions
- \ \ Black laminate bottom plate with steel support plates
- \ \ Includes clear non-glare protective lenses
- \ \ Requires assembly

**PYL-TR Series**

**PYL-TR**

- \ \ Triangular shaped standing pylon display
- \ \ Choice of silver or black frames/extrusions
- \ \ Black laminate bottom plate with steel support plates
- \ \ Black powder coated steel top plate for PYL-TR1 & 2/Thermoformed plate on PYL-TR3
- \ \ Includes clear non-glare protective lenses
- \ \ Requires assembly

**IC-TR Series**

**IC-TR**

- \ \ Triangular shape
- \ \ Silver or black curved high quality aluminum extrusions
- \ \ Silver aluminum post, silver steel domed foot plate
- \ \ Black powder-coated steel top and bottom plate
- \ \ Clear non-glare protective lenses can be removed for a quick graphic change
- \ \ Custom heights available
- \ \ Requires assembly

**IC-DBL Series**

**IC-DBL**

- \ \ Silver or black curved high quality aluminum extrusions
- \ \ Silver aluminum post, silver steel domed foot plate
- \ \ Black powder-coated steel bottom plate, black molded plastic top plate
- \ \ Clear non-glare protective lenses can be removed for a quick graphic change
- \ \ Double sided
- \ \ Custom heights available
- \ \ Requires assembly



THE SIGN MAKERS'®  
**HAND  
BOOK**  
WAYFINDING SYSTEMS

// **LET'S TALK!**



[www.signmakershandbook.com](http://www.signmakershandbook.com)

