

SPECIFICATIONS

GENERAL

Aluminum framing shall be Marlin System 45T Front-Set thermally improved as manufactured by Marlin windows.

MATERIALS

All framing shall be aluminum extrusions of 6063-T5 alloy & temper with a minimum wall thickness of .094". All members shall have a rigid polyurethane "thermal-barrier" as an integral part of the extrusion which eliminates all direct contact between the interior and exterior aluminum sections. Glazing gaskets shall be extruded E.P.D.M. System shall accommodate vertical structural silicone butt glazing (Architect specify).

FINISH

Standard architectural Class II anodic color conforming to Aluminum Association AA-M12-C22-A34 for dark bronze or AA-M12-C22-A31 for clear anodize. (Architectural Class I and Class II anodic finishes and organic coatings available - specify).

CONSTRUCTION

Aluminum framing shall have a 2 1/4" face width and a depth of 4 1/2" and provide for flush glazing without projecting stops. Head and sill members shall have a face dimension of 2 1/2" and depth of 5". Optional thermally improved concealed project-in vent (Architect specify). Additional sight line shall not exceed 1/2".

Maximum vent 60" x 36".

PERFORMANCE

System shall be tested in accordance with AAMA 501 and meet the requirements of ASTM E 283 for air infiltration, and ASTM E 331 for water penetration, and ASTM E 330 for structural performance. Deflection of mullions shall be limited to L/175 when subjected to the project design pressure of _____P.S.F. (Architect to specify). Marlin System 55 shall have a minimum condensation resistance factor of 60.

GLAZING

Marlin system 45T FS shall accommodate 1" glazing as required. Provisions for 1/4" glazing shall be accommodated by use of an adapter.

INSTALLATION

Glass and framing shall be installed straight, plumb, and level without twisting and securely anchored in place. All joints between framing and the building exterior shall be sealed to provide a watertight installation.

PROTECTION AND CLEANING

The General Contractor shall provide adequate protection of the aluminum and glass surfaces from damage by grinding compound, lime, acids, cement or other contaminants. The General Contractor shall be responsible for final cleaning.

1/4 SCALE

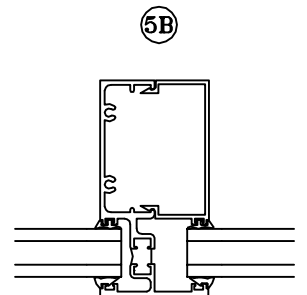
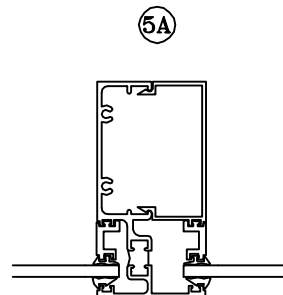
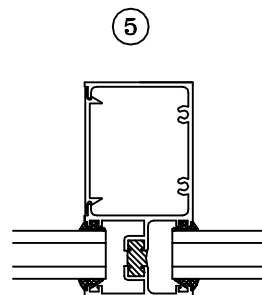
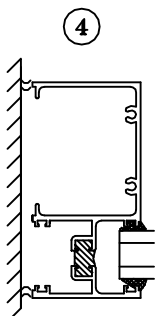
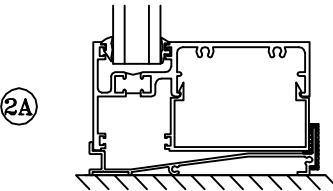
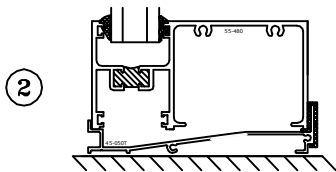
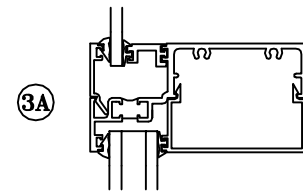
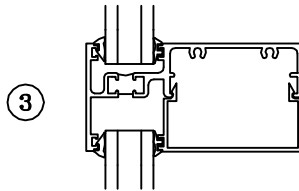
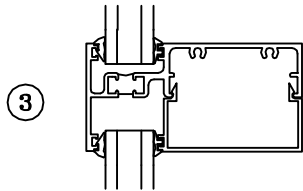
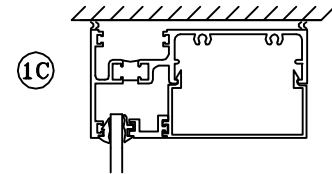
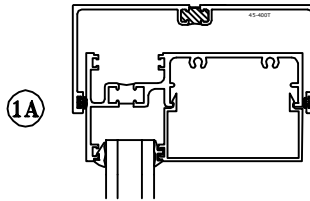
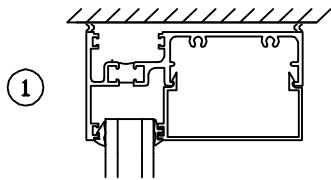
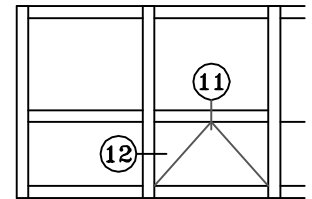
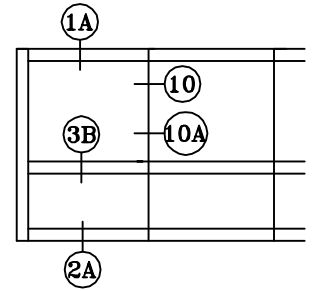
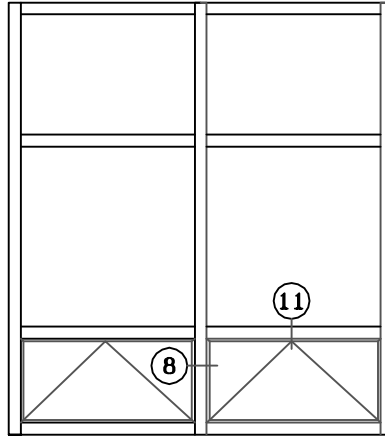
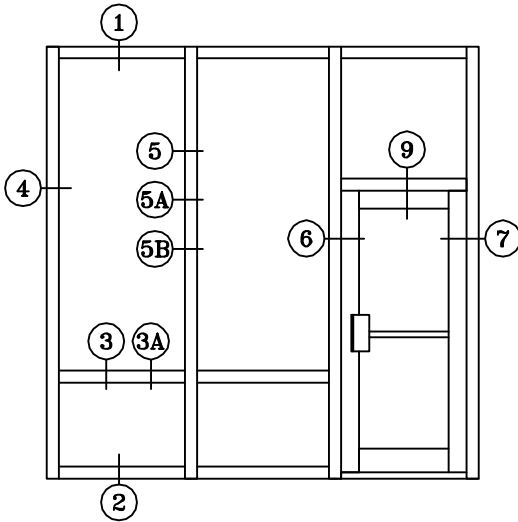

1/4 SCALE

6

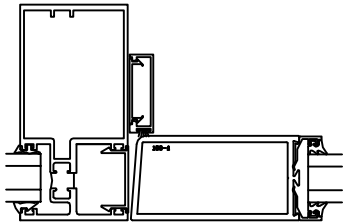

7

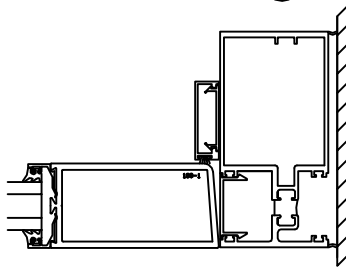

8

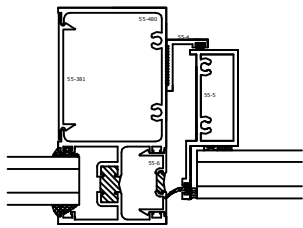
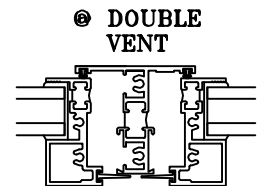

LOW PROFILE VENT

9

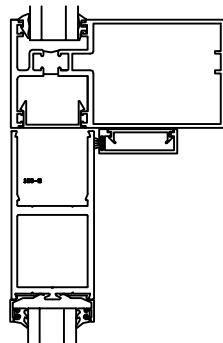

10

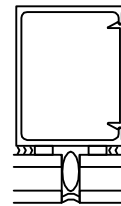

10A

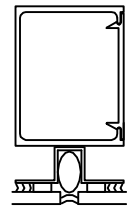

11

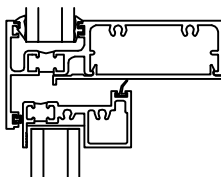

12

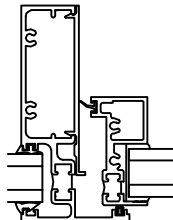

CORNER POST

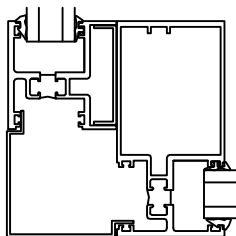

90 DEG BUTT GLAZE CORNER

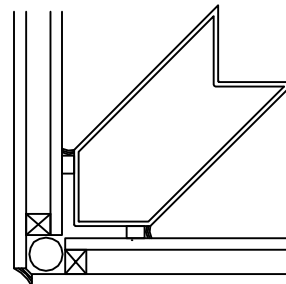

A = 15 PSF
B = 20 PSF
C = 25 PSF
D = 30 PSF

WIND LOAD CHARTS

DEFLECTION LIMITED TO L/175

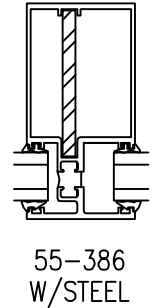
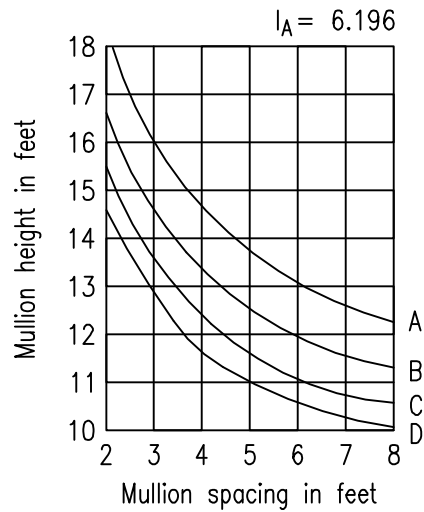
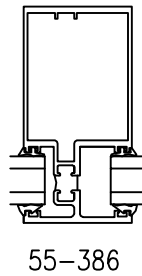
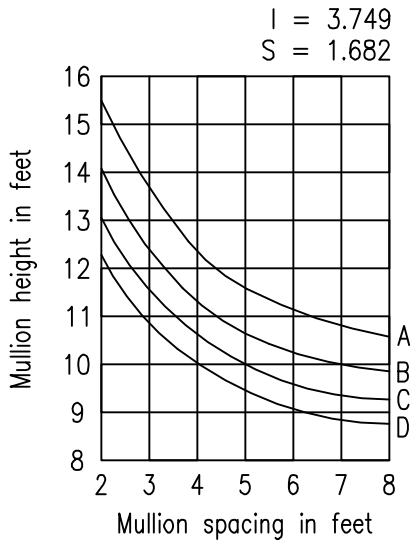

DEAD LOADS

1/4 POINT LOADING (A)
1/8 POINT LOADING (B)

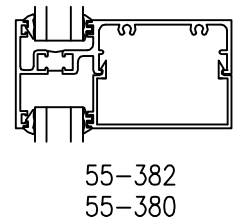
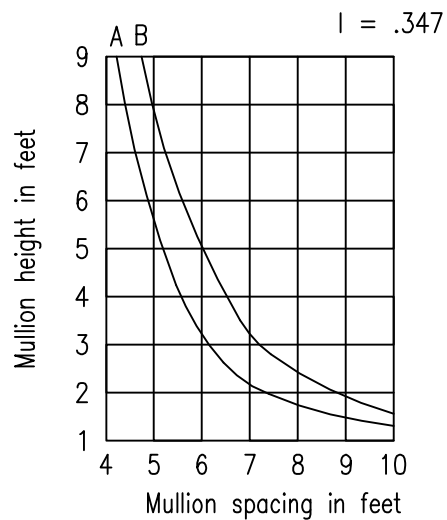
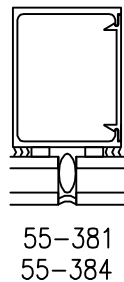
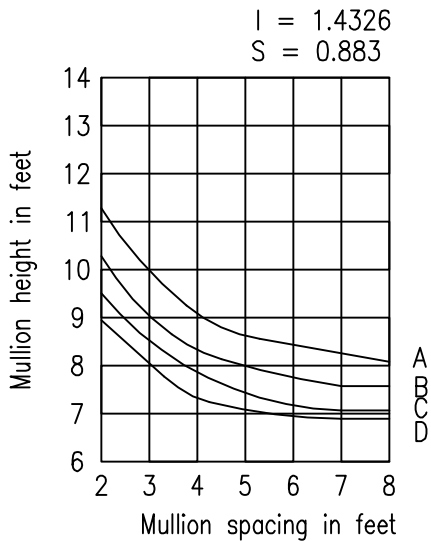

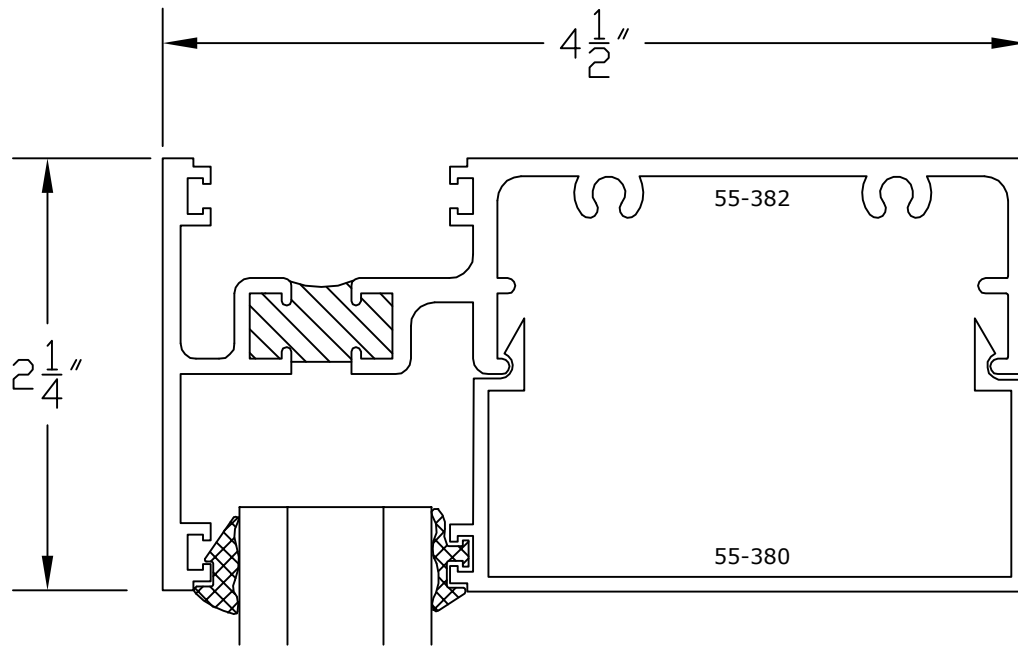

① HEAD

② SILL

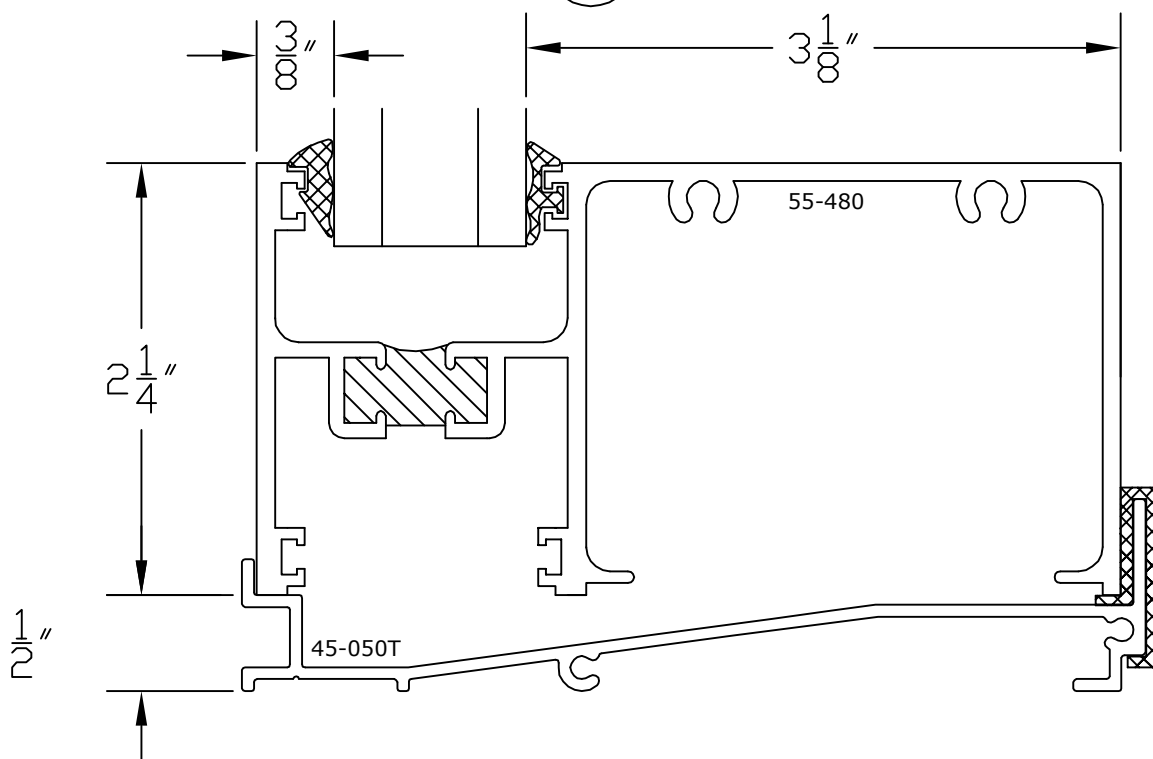

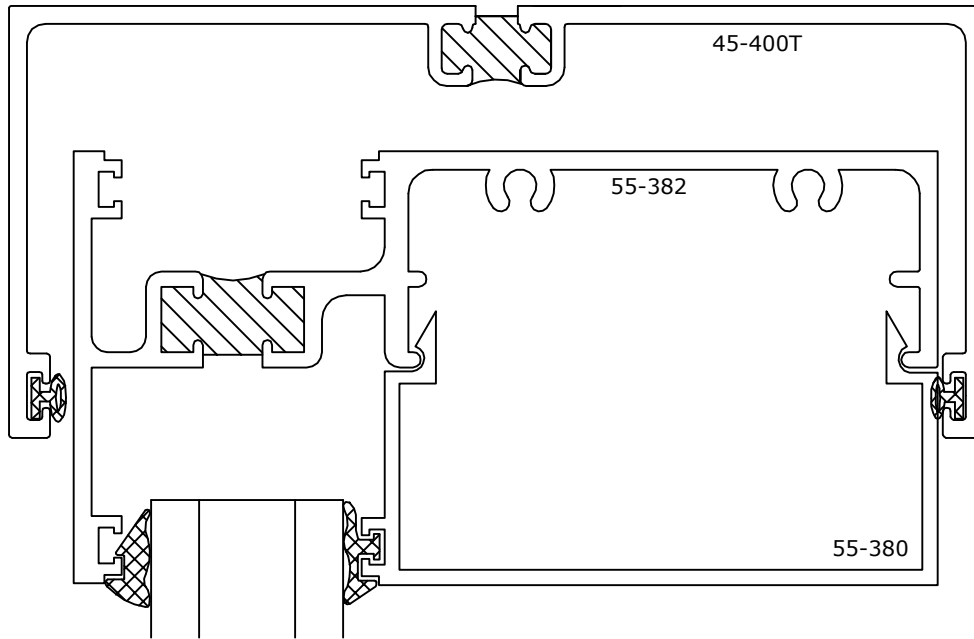

1A HEAD

2A SILL

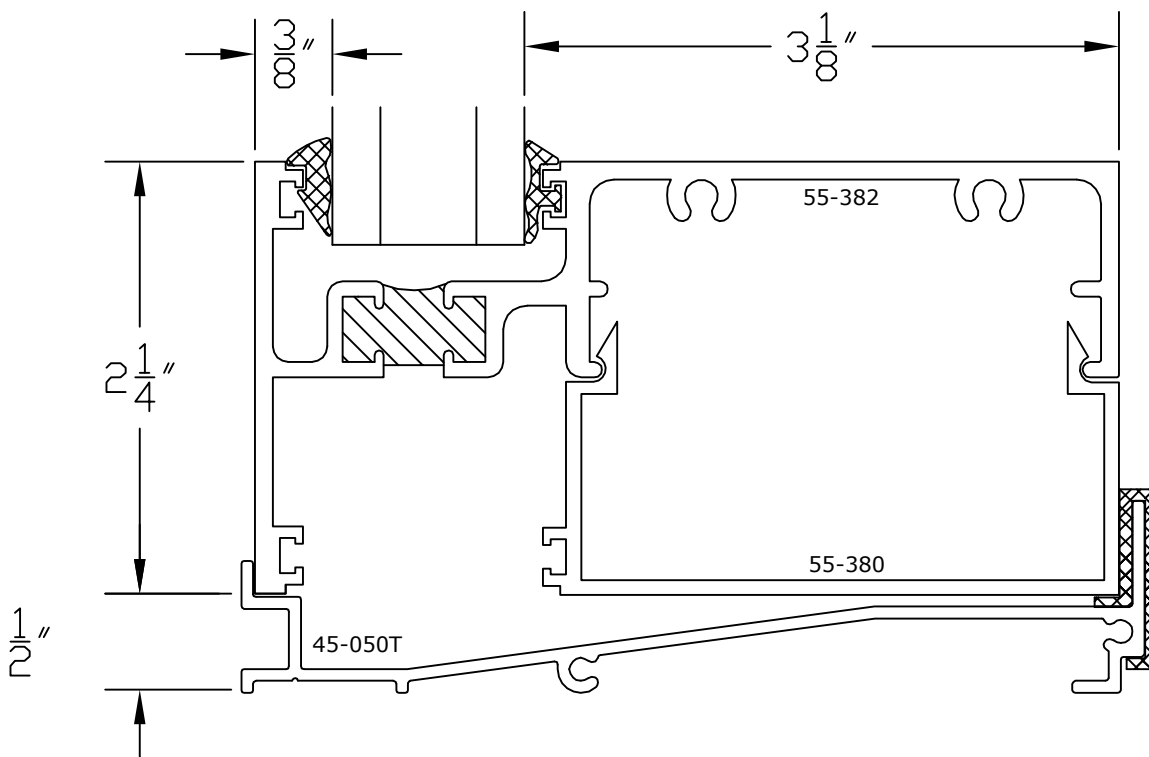

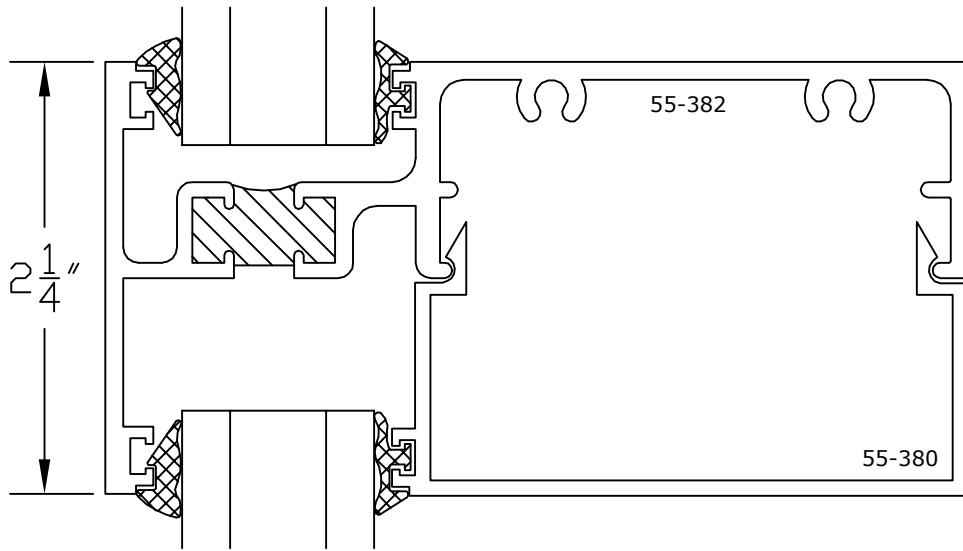

3 HORIZONTAL
INSIDE GLAZED

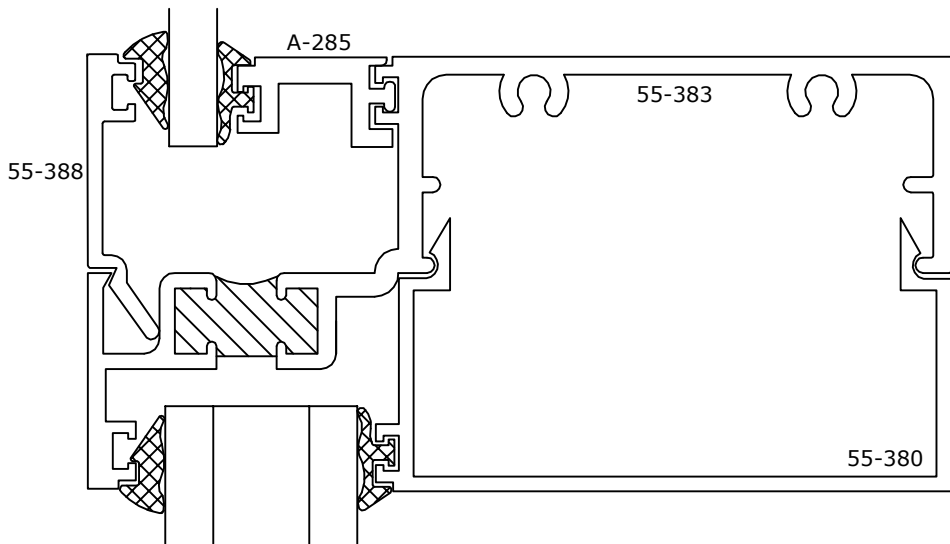

3A HORIZONTAL
OUTSIDE
GLAZED

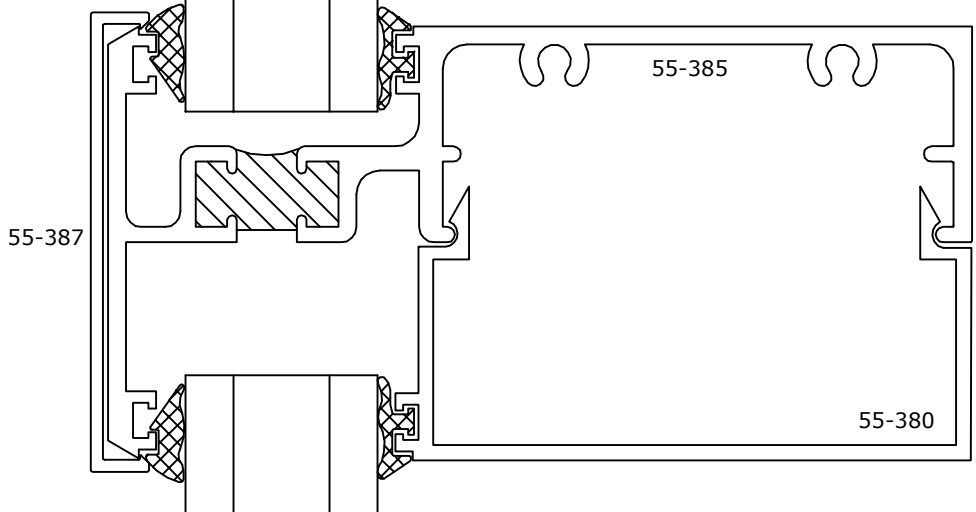

3B HORIZONTAL
FOR
BUTT GLAZE

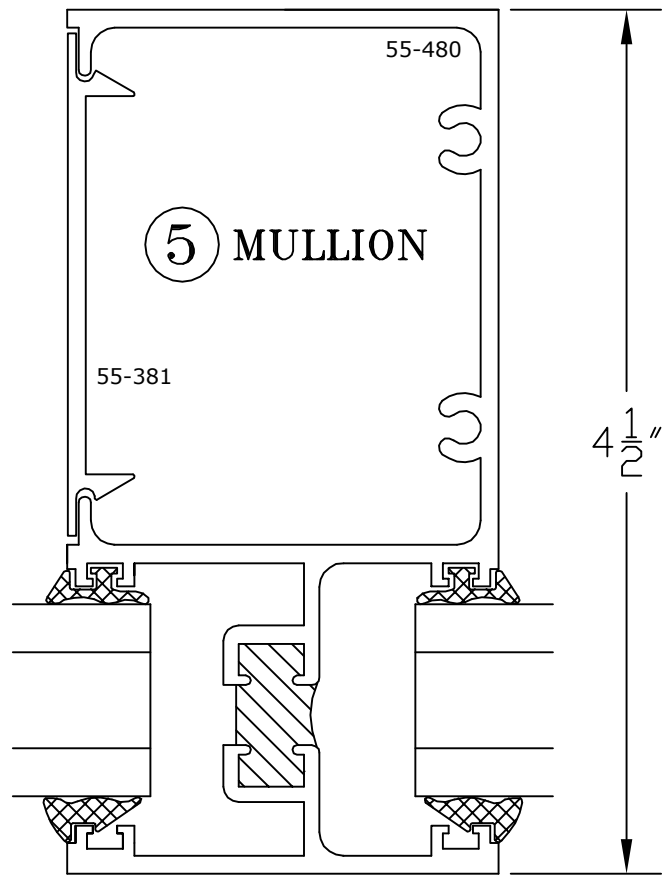
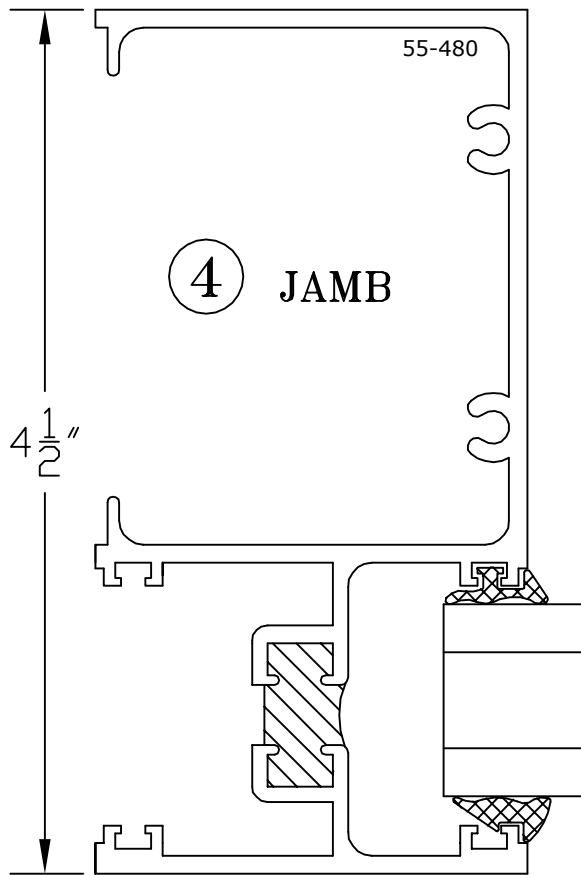

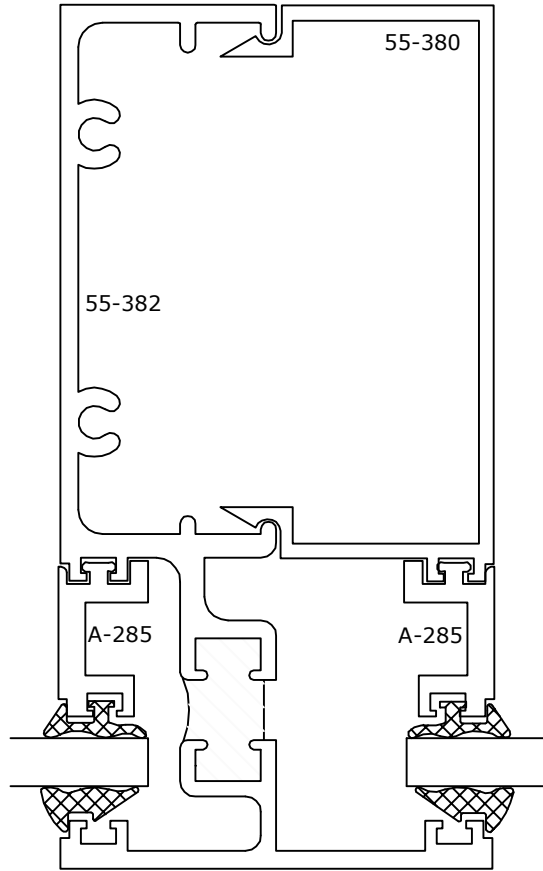

5A MULLION

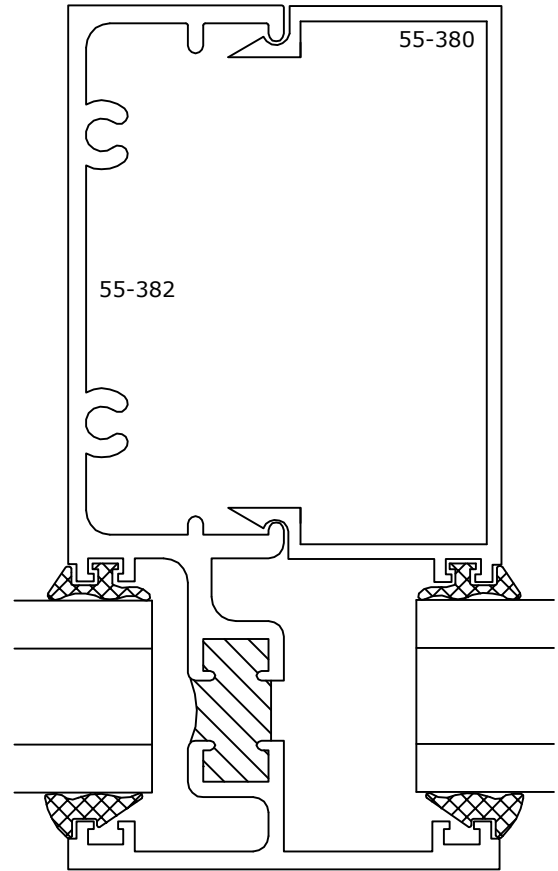

5B MULLION

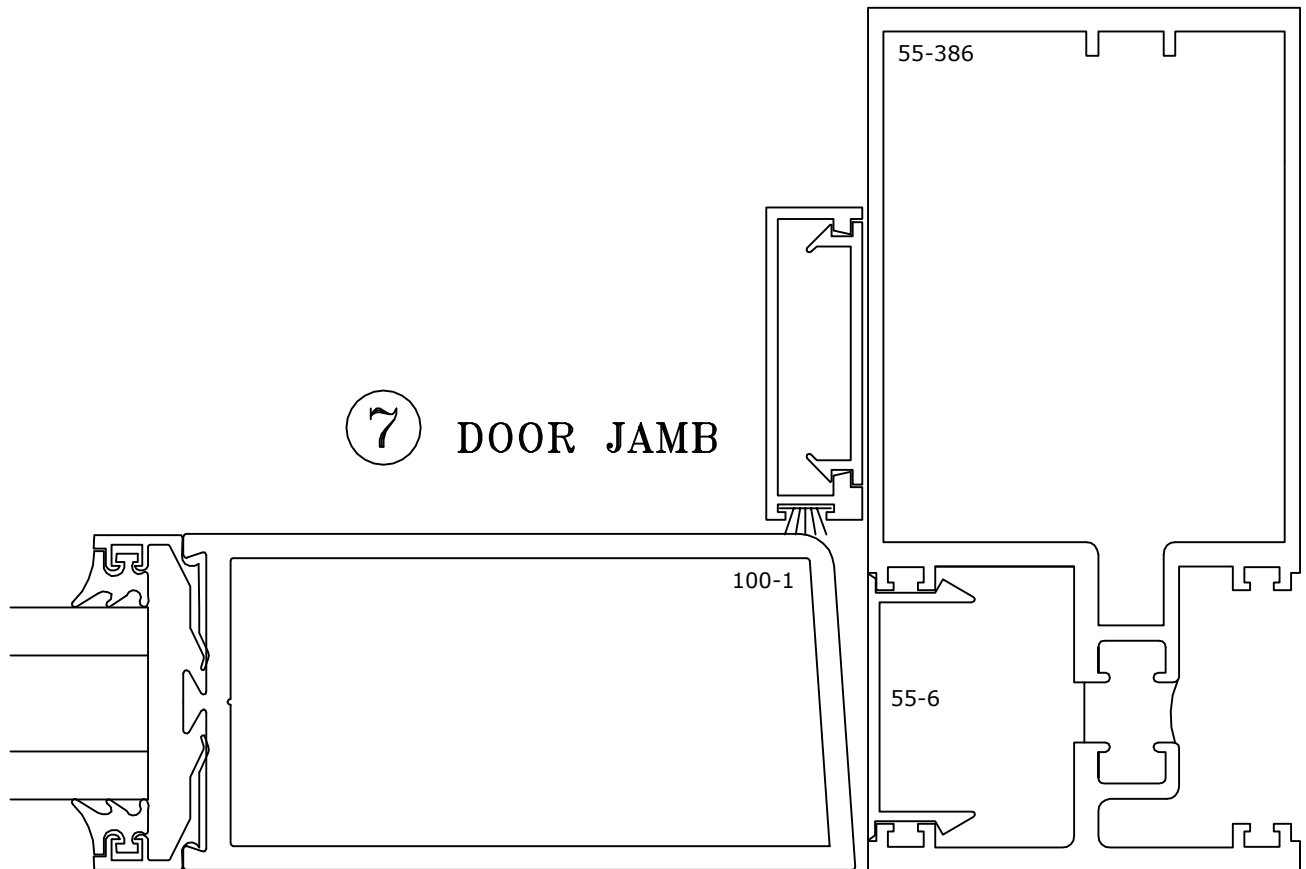
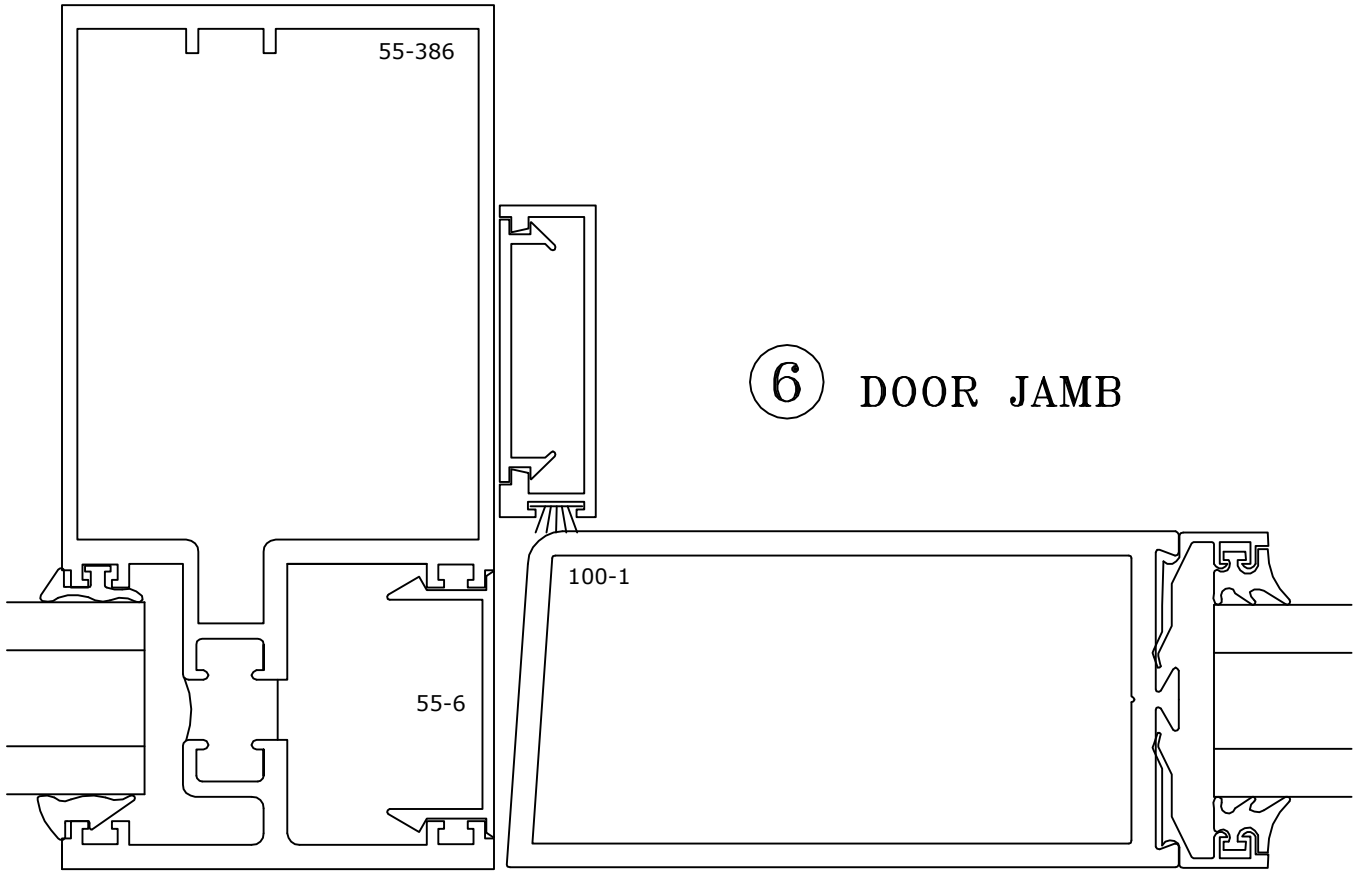

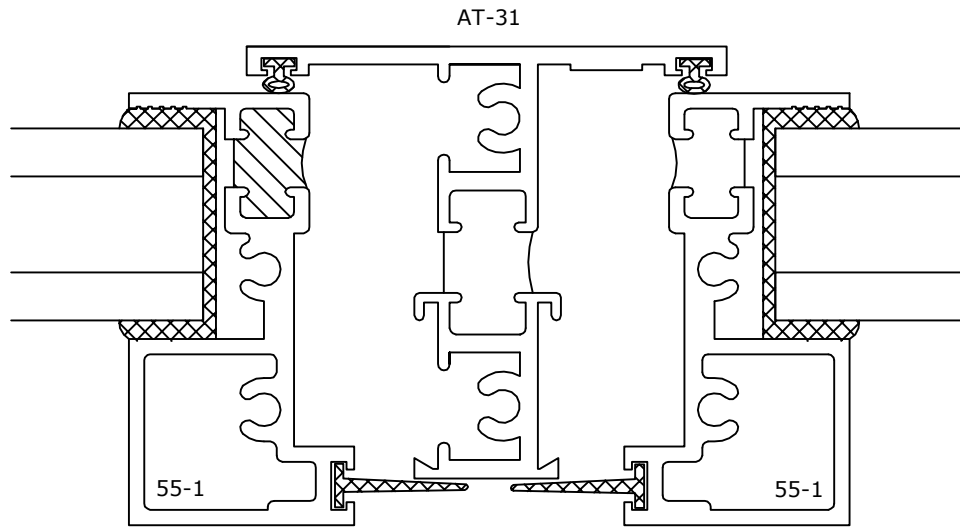

⑧ @ DOUBLE VENT

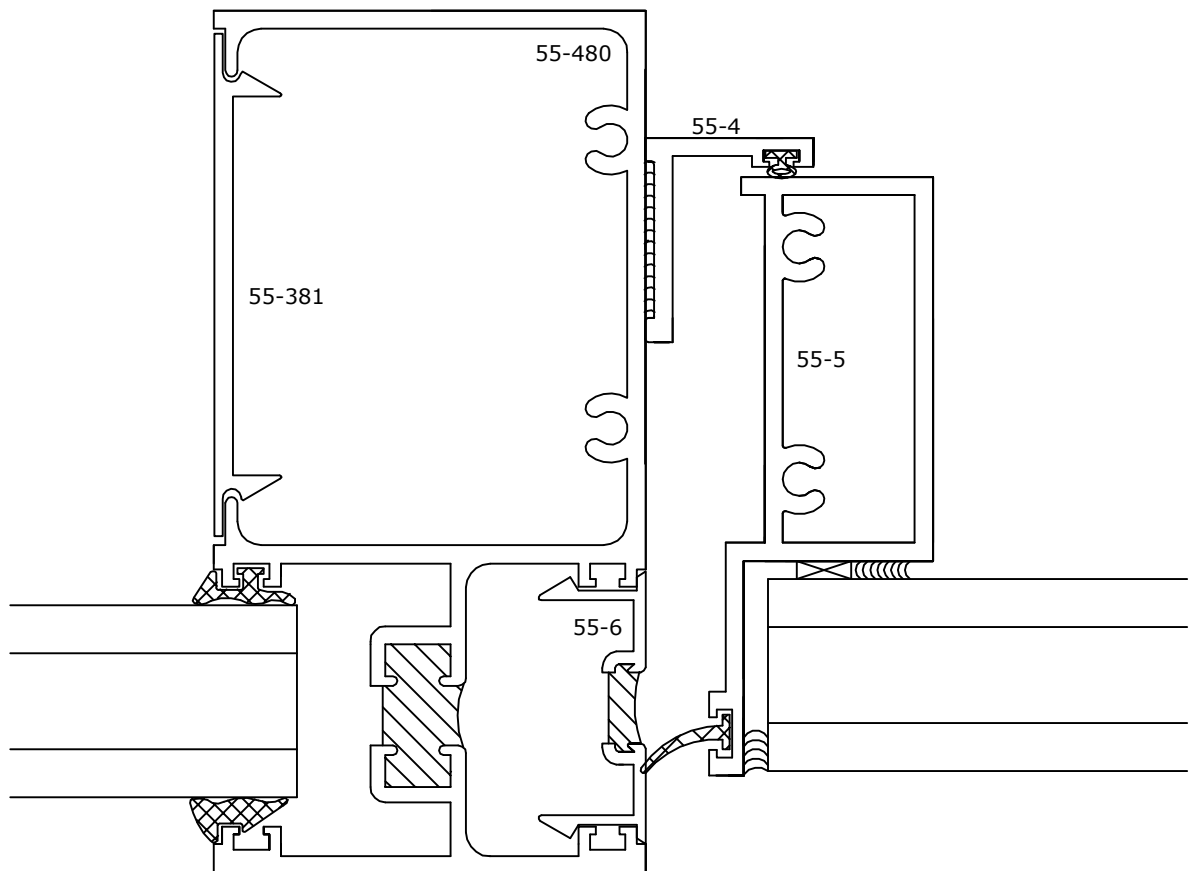

LOW PROFILE VENT

9 DOOR HEAD

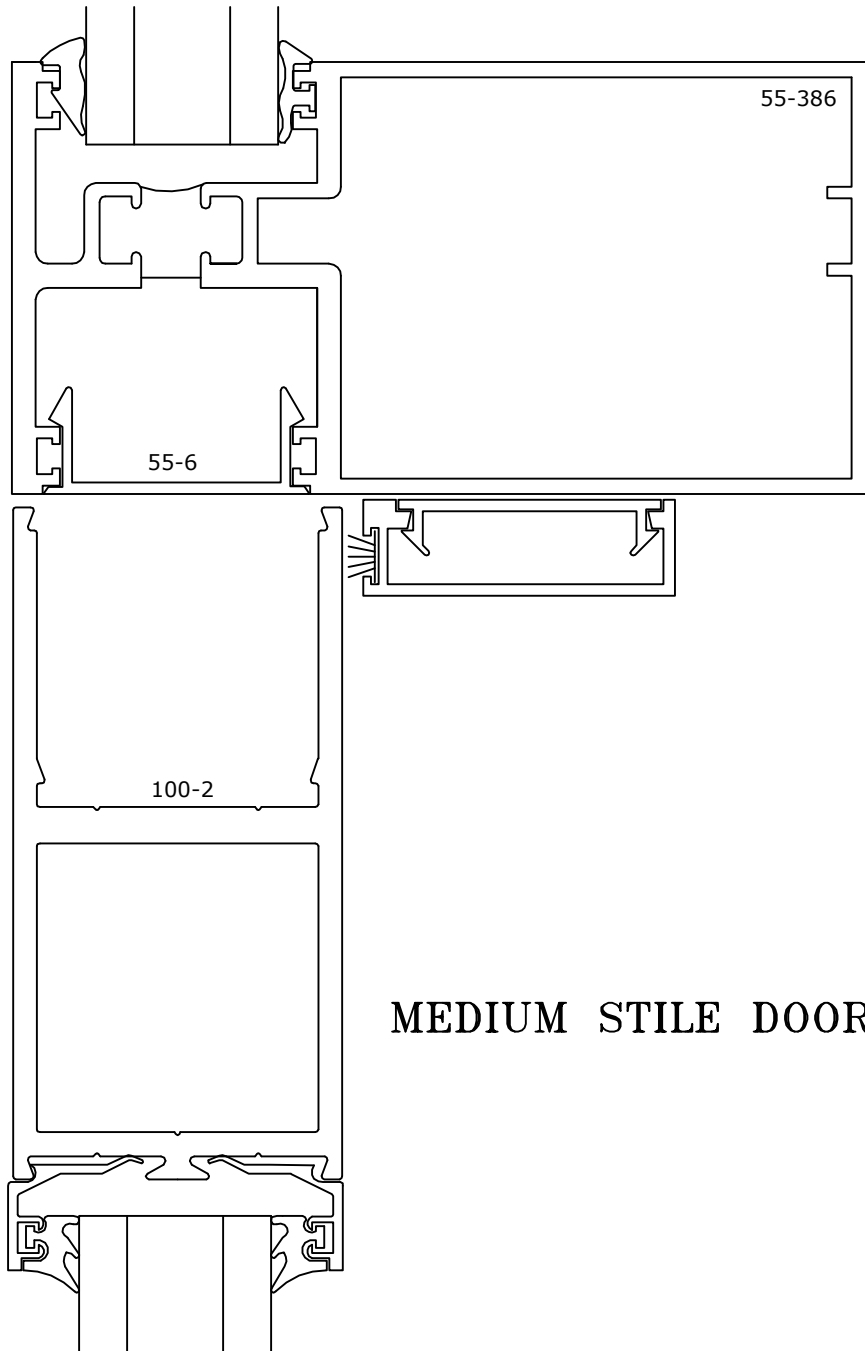

MEDIUM STILE DOOR

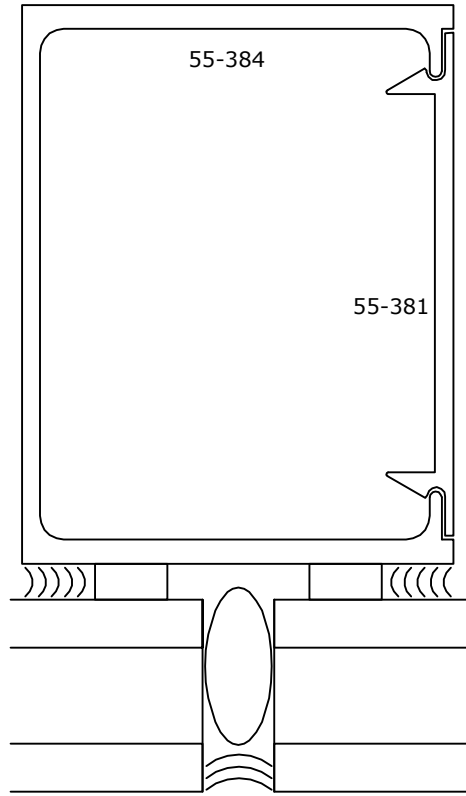

10 VERTICAL BUTT GLAZE

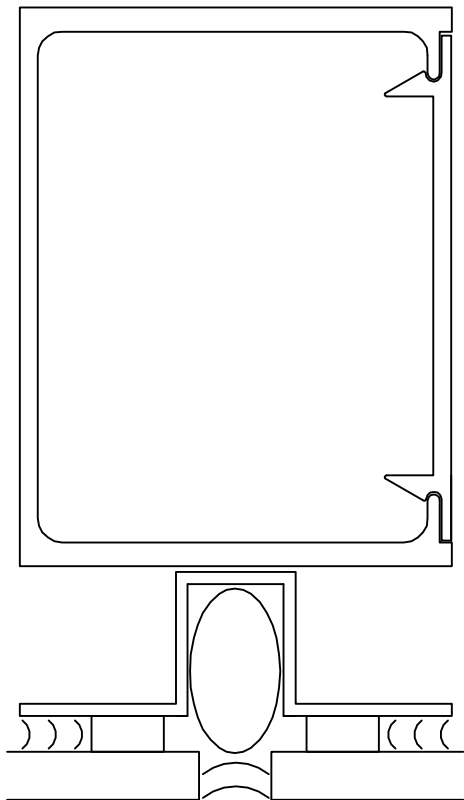

10A VERTICAL BUTT GLAZE
SINGLE GLAZE

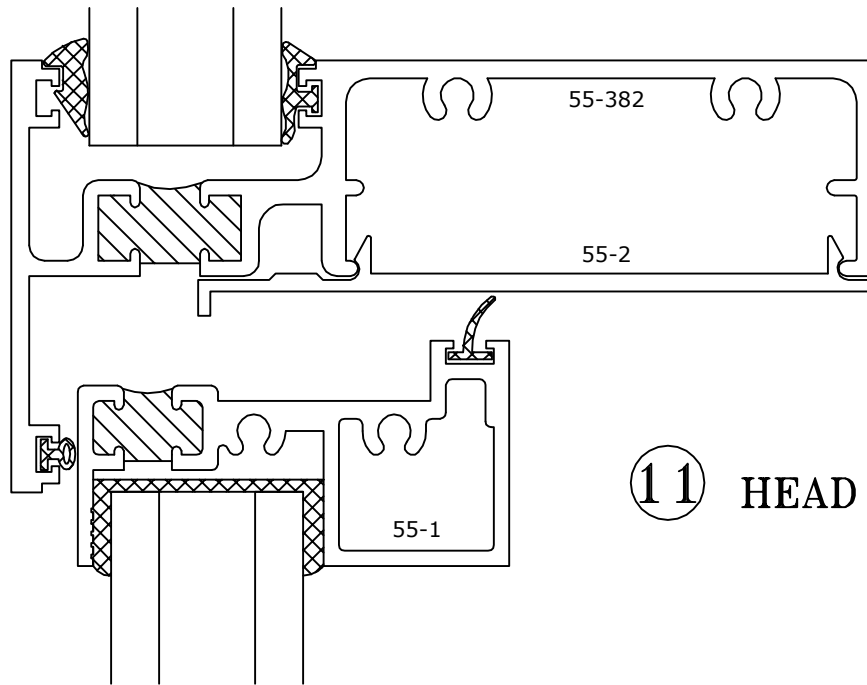

① HEAD @ VENT

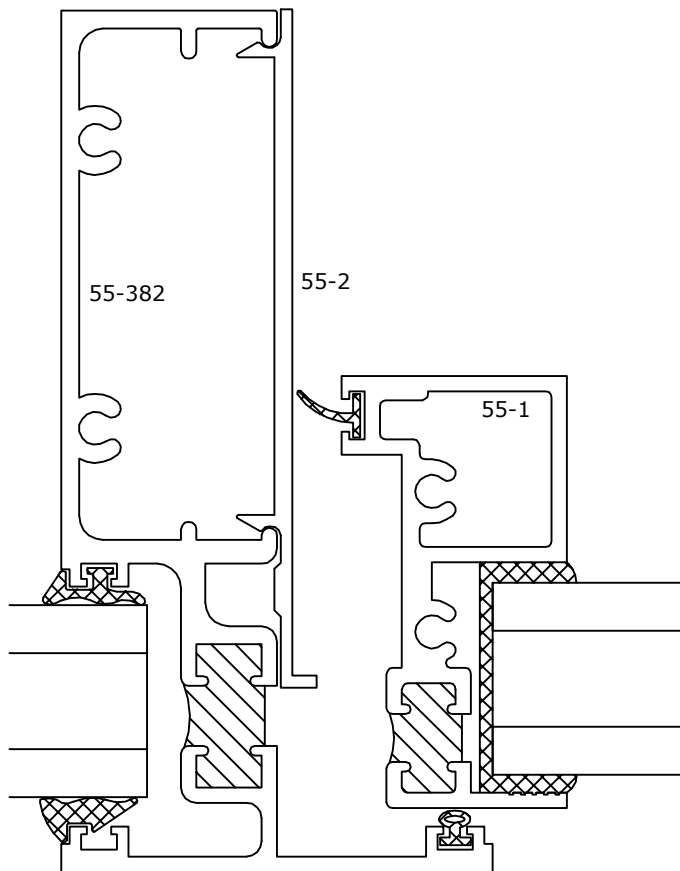

② MULLION @ VENT

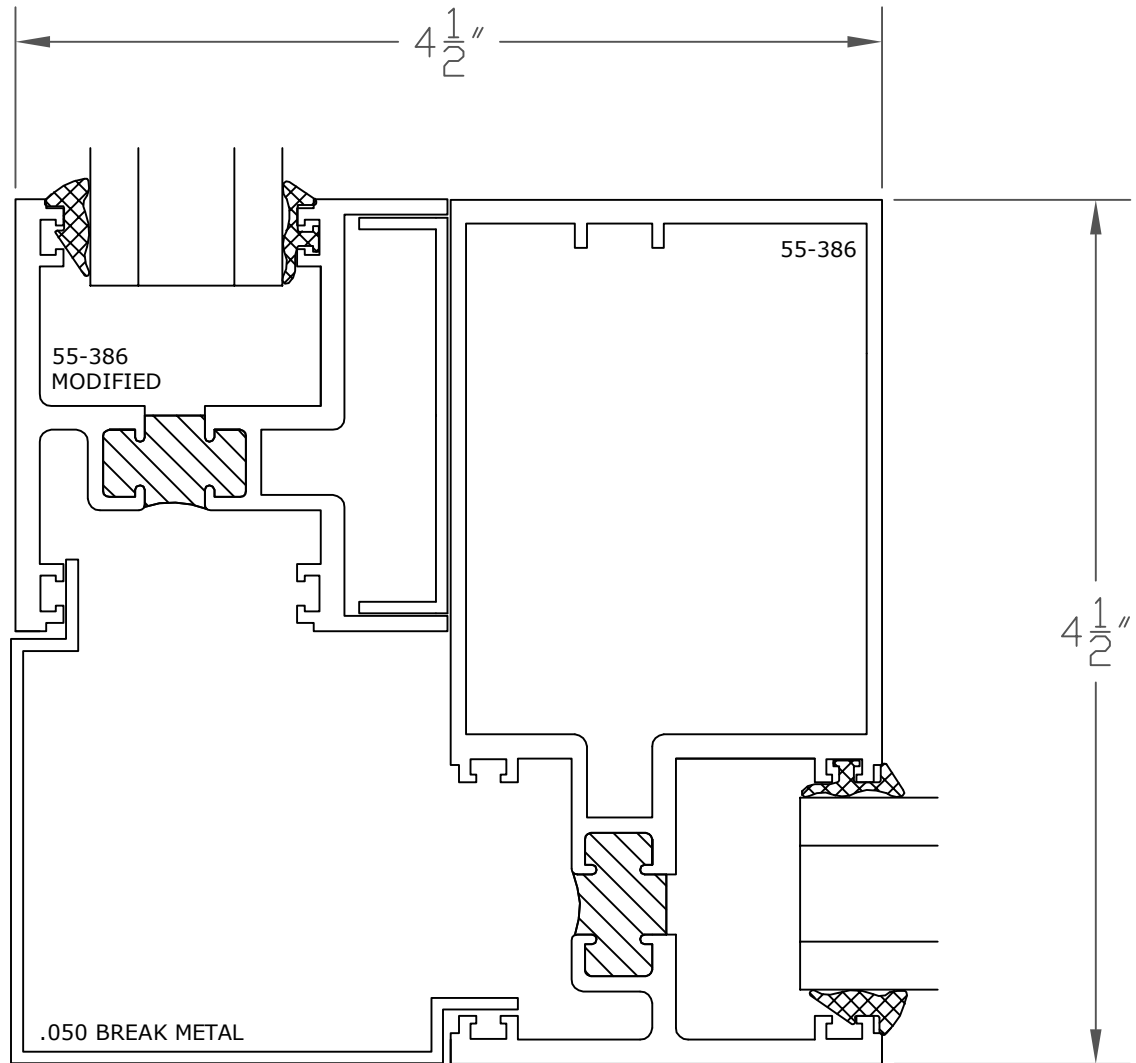

CORNER POST

BUTT GLAZE CORNER

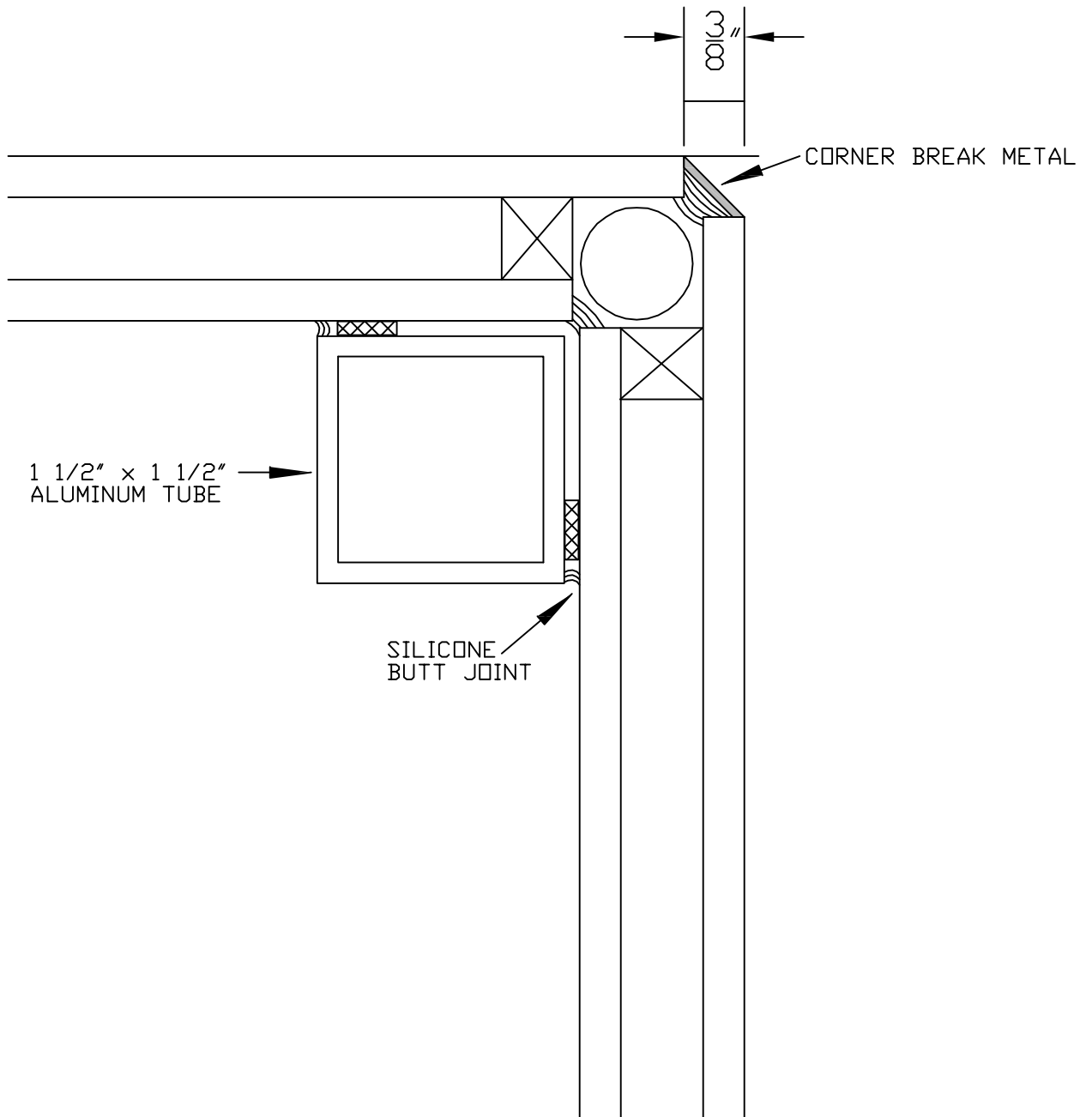

1/4 SCALE

FRONT/BACK GLAZING

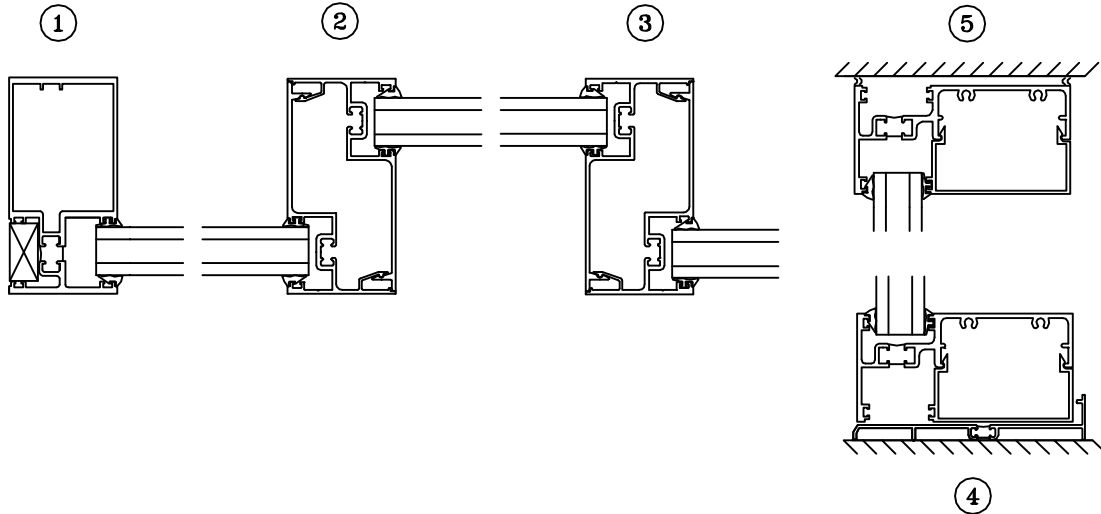
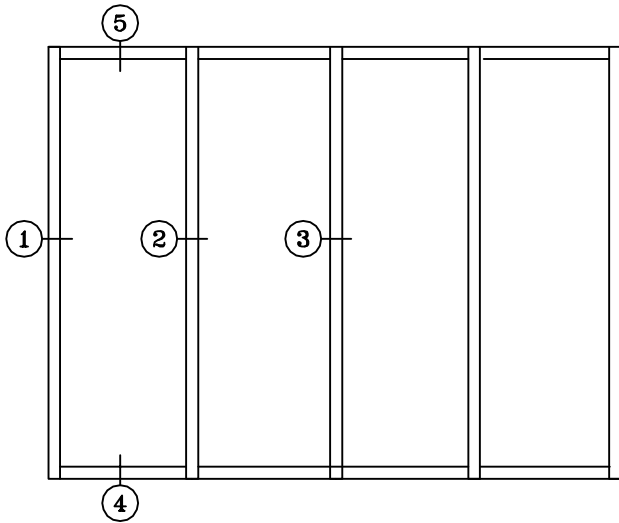

FRONT/BACK GLAZING

① JAMB

② MULLION

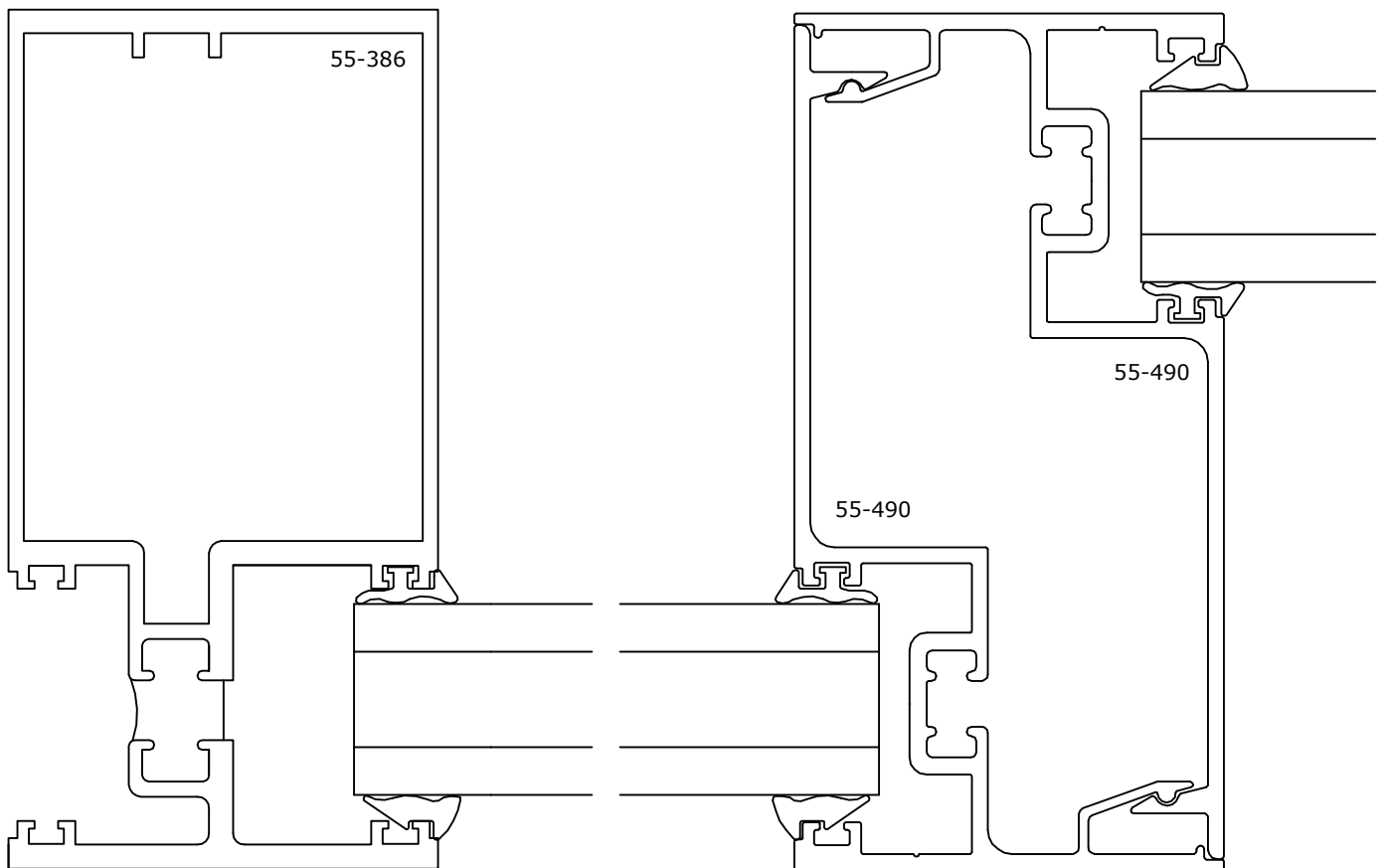

FRONT/BACK GLAZING

3 MULLION

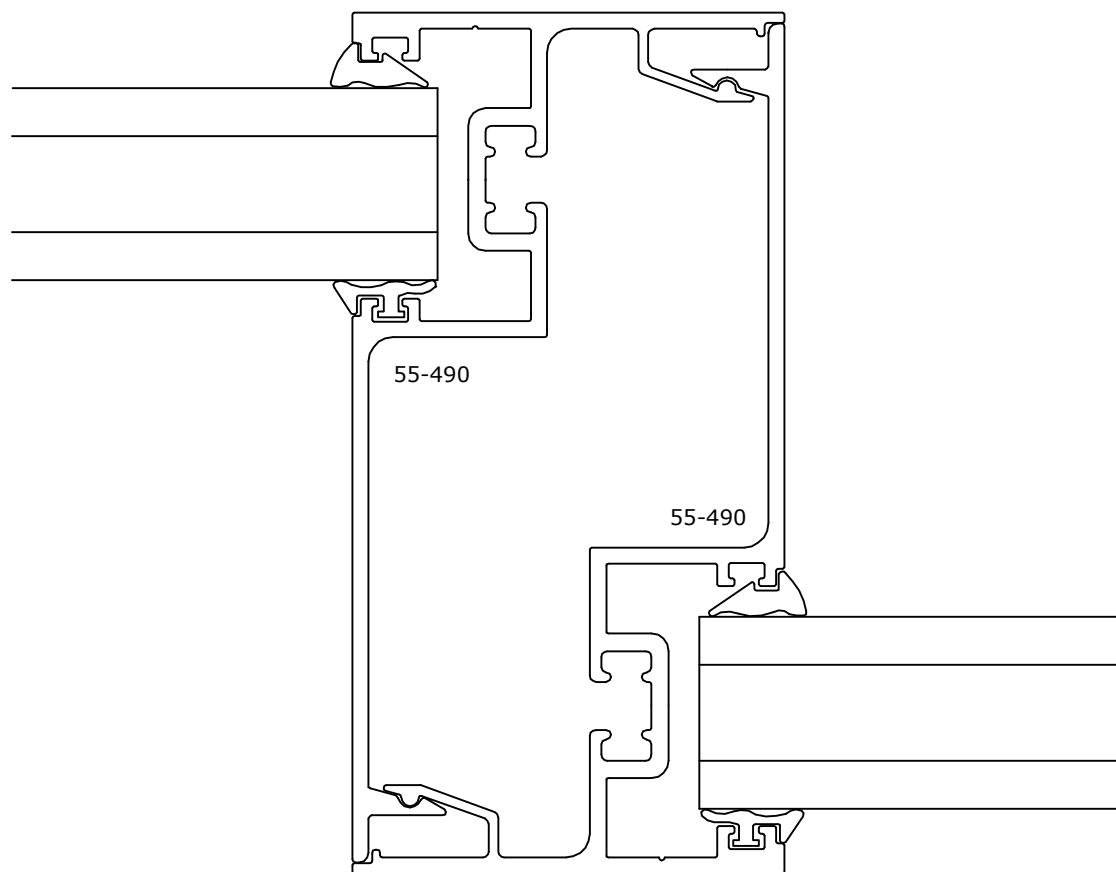

FRONT/BACK GLAZING

