

**Turbocharger Coolant Feed Pip...****TURBOCHARGER COOLANT FEED PIPE REPLACEMENT (1.4L LE2) (ENGINE HEATING AND COOLING)**Document ID#  
3940296**TURBOCHARGER COOLANT FEED PIPE REPLACEMENT (1.4L LE2) (ENGINE HEATING AND COOLING)****Removal Procedure**

1. Drain the cooling system. [Cooling System Draining and Filling](#)
2. [Warm Up Three-Way Catalytic Converter Replacement](#) » Remove

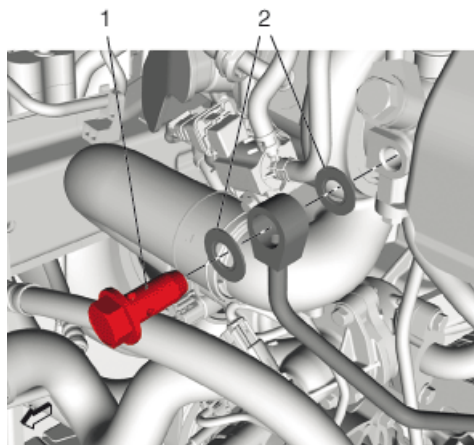

3. Turbocharger Coolant Feed Pipe Fastener (1) » Remove .
4. Remove and DISCARD the 2 turbocharger coolant feed pipe gaskets (2).

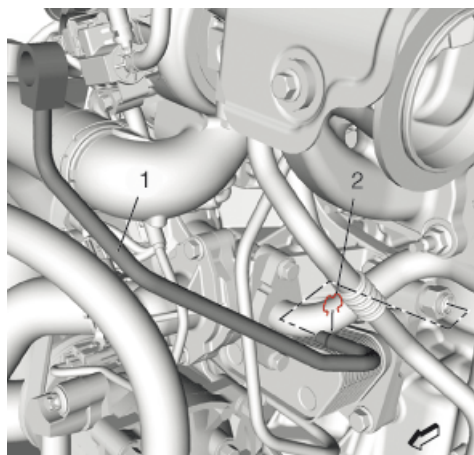

5. Remove and DISCARD the turbocharger coolant feed pipe clamp (2).
6. Turbocharger Coolant Feed Pipe (1) » Remove .

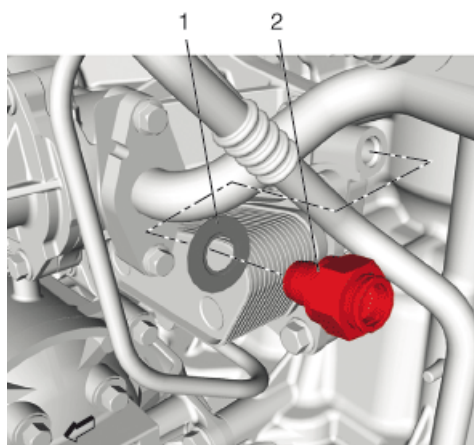

**Note:** The turbocharger coolant feed pipe fitting is not reusable.

7. Remove and DISCARD the turbocharger coolant feed pipe fitting (2).
8. Remove and DISCARD the turbocharger coolant feed pipe fitting gasket (1).

### Installation Procedure

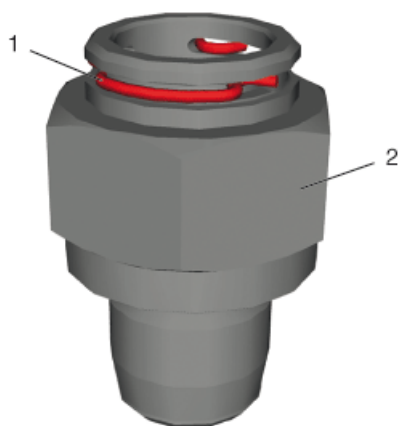

1. The clamp (1) from the turbocharger coolant feed pipe fitting (2) is pre installed.

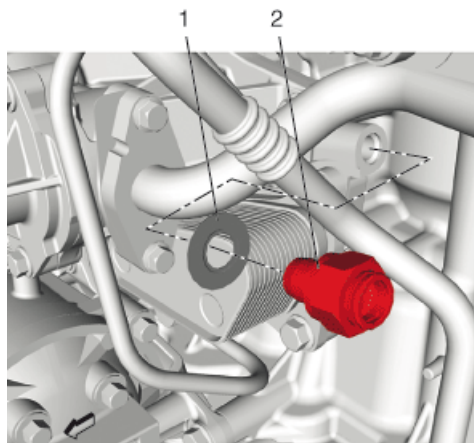

2. Install a NEW turbocharger coolant feed pipe fitting gasket (1).

**Caution:** Refer to [Fastener Caution](#) .

**Note:** Do not remove the turbocharger coolant pipe fitting clamp.

**Note:** The turbocharger coolant feed pipe fitting is not reusable.

3. Install the turbocharger coolant feed pipe fitting (2) and tighten to **35 N•m (26 lb ft)** .

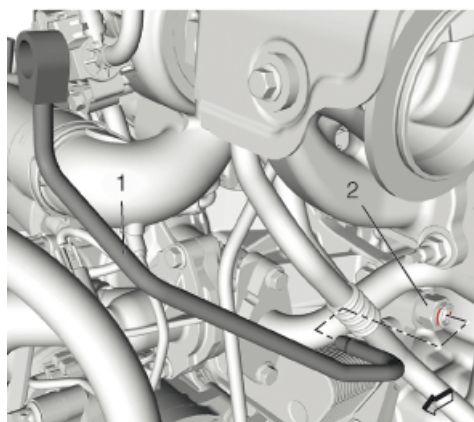

4. Clip in the turbocharger coolant feed pipe (1) to the turbocharger coolant feed pipe fitting (2).

5. Pull back on pipe to be sure it is seated correctly in the clamp.

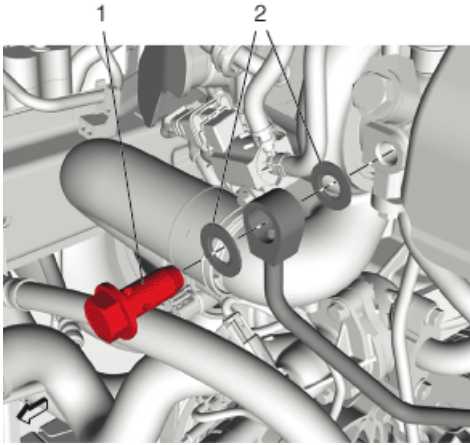

6. Install 2 NEW turbocharger coolant feed pipe gaskets (2).
7. Turbocharger Coolant Feed Pipe Fastener (1) Install and tighten **35 N•m (26 lb ft)** .
8. [Warm Up Three-Way Catalytic Converter Replacement](#) » Install
9. [Cooling System Draining and Filling](#) » Fill the cooling system.

---

Portions of materials contained herein are sourced from General Motors Inc., Co.

Copyright 2007 - 2018 Service Repair Solutions, Inc.