

Functionsmith, Inc.

Add: 779 Acacia Street, Octagon Industrial Estate Subdivision,  
Barangay Dela Paz, Pasig City, 1600, Philippines

Tel: (02)8645-4994

Email: sales@functionsmith.com  
marketing@functionsmith.com

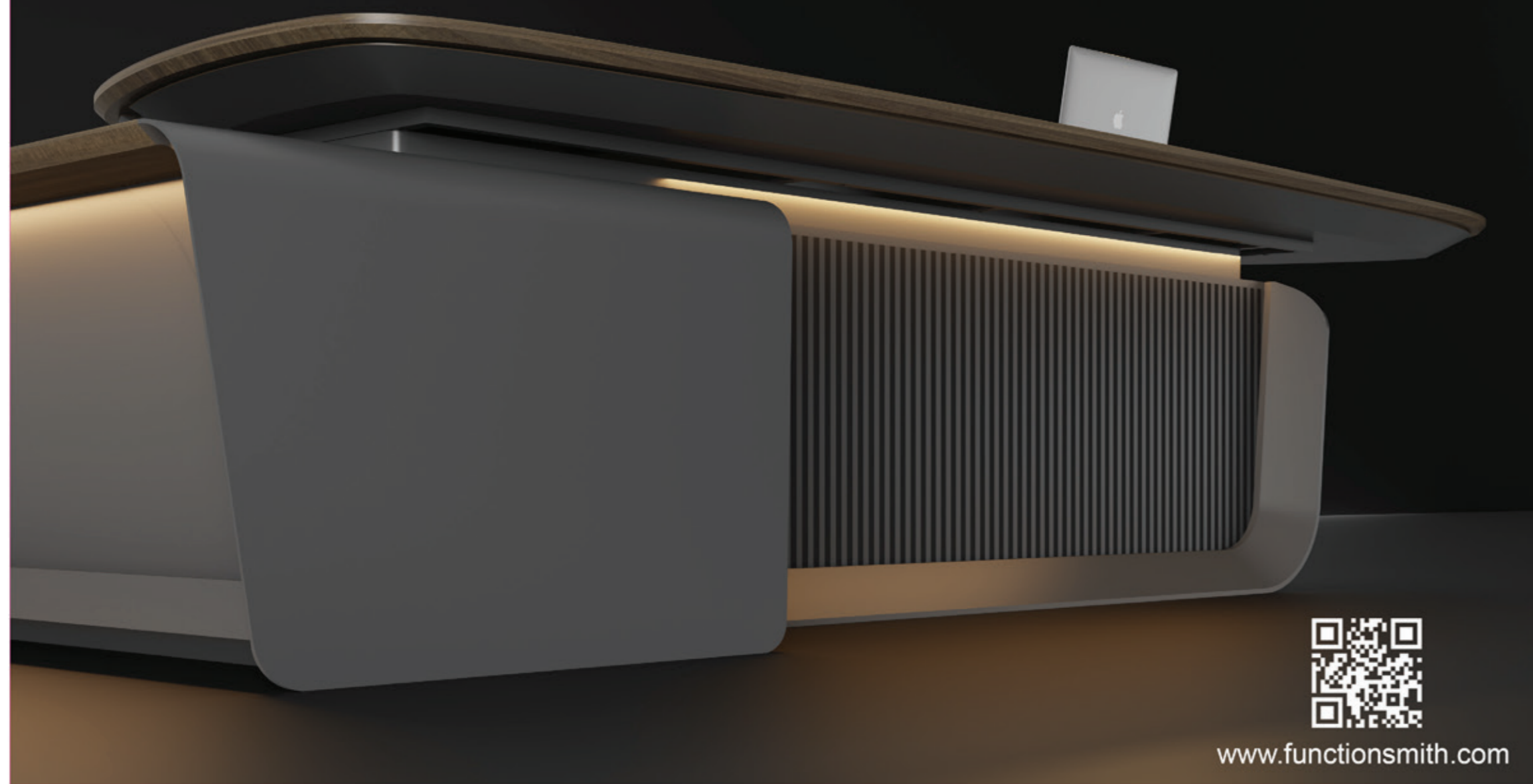

[www.functionsmith.com](http://www.functionsmith.com)

# MODERN OFFICE





**B102-2424**  
2400Wx2400Dx750Hmm

**B102-2824**  
2800Wx2400Dx750Hmm

**B102-3624**  
3600Wx2400Dx750Hmm

**B102-2624**  
2600Wx2400Dx750Hmm

**B102-3224**  
3200Wx2400Dx750Hmm

**S102-36**  
3600Wx400Dx2100Hmm



**FUNCTIONSMITH, INC.**  
MANILA • GUANGZHOU



**B113-1818**  
1800Wx1800Dx750Hmm

**B113-2018**  
2000Wx1800Dx750Hmm

**S107-24**  
2400Wx400Dx2000Hmm



**B121-2018**  
2000Wx1800Dx750Hmm

**B121-2418**  
2400Wx1800Dx750Hmm

**B121-2218**  
2200Wx1800Dx750Hmm

**S121-28**  
2800Wx400Dx2000Hmm





**FUNCTIONSMITH, INC.**  
MANILA • GUANGZHOU

**B107-1414**  
1400Wx1400Dx750Hmm

**B107-1616**  
1600Wx1600Dx750Hmm

**B107-1816**  
1800Wx1600Dx750Hmm

**B107-2016**  
2000Wx1600Dx750Hmm

**S811-2 /S811-3**  
800/1200Wx400Dx2000Hmm



**FUNCTIONSMITH, INC.**  
MANILA • GUANGZHOU



**FUNCTIONSMITH, INC.**  
MANILA • GUANGZHOU

**B108-1414**  
1400Wx1400Dx750Hmm

**B108-1816**  
1800Wx1600Dx750Hmm

**B108-2216**  
2200Wx1600Dx750Hmm

**B108-1616**  
1600Wx1600Dx750Hmm

**B108-2016**  
2000Wx1600Dx750Hmm

**S811-2 /S811-3**  
800/1200Wx400Dx2000Hmm



**FUNCTIONSMITH, INC.**  
MANILA • GUANGZHOU

**H103-2012**  
2000Wx1200Dx750Hmm

**H103-2812**  
2800Wx1200Dx750Hmm

**H103-3612**  
3600Wx1200Dx750Hmm

**H103-2412**  
2400Wx1200Dx750Hmm

**H103-3212**  
3200Wx1200Dx750Hmm





**H102-2812**  
2800Wx1200Dx750Hmm

**H102-3614**  
3600Wx1400Dx750Hmm

**H102-4816**  
4800Wx1600Dx750Hmm

**H102-3212**  
3200Wx1200Dx750Hmm

**H102-4516**  
4500Wx1600Dx750Hmm

**H102-6018**  
6000Wx1800Dx750Hmm



**S102-36**  
3600Wx400Dx2100Hmm



**S121-28**  
2800Wx400Dx2000Hmm



**S107-24**  
2400Wx400Dx2000Hmm



**A102**  
2100Wx400Dx960Hmm



**C121-1206**  
1200Wx600Dx450Hmm

**C121-1407**  
1400Wx700Dx450Hmm

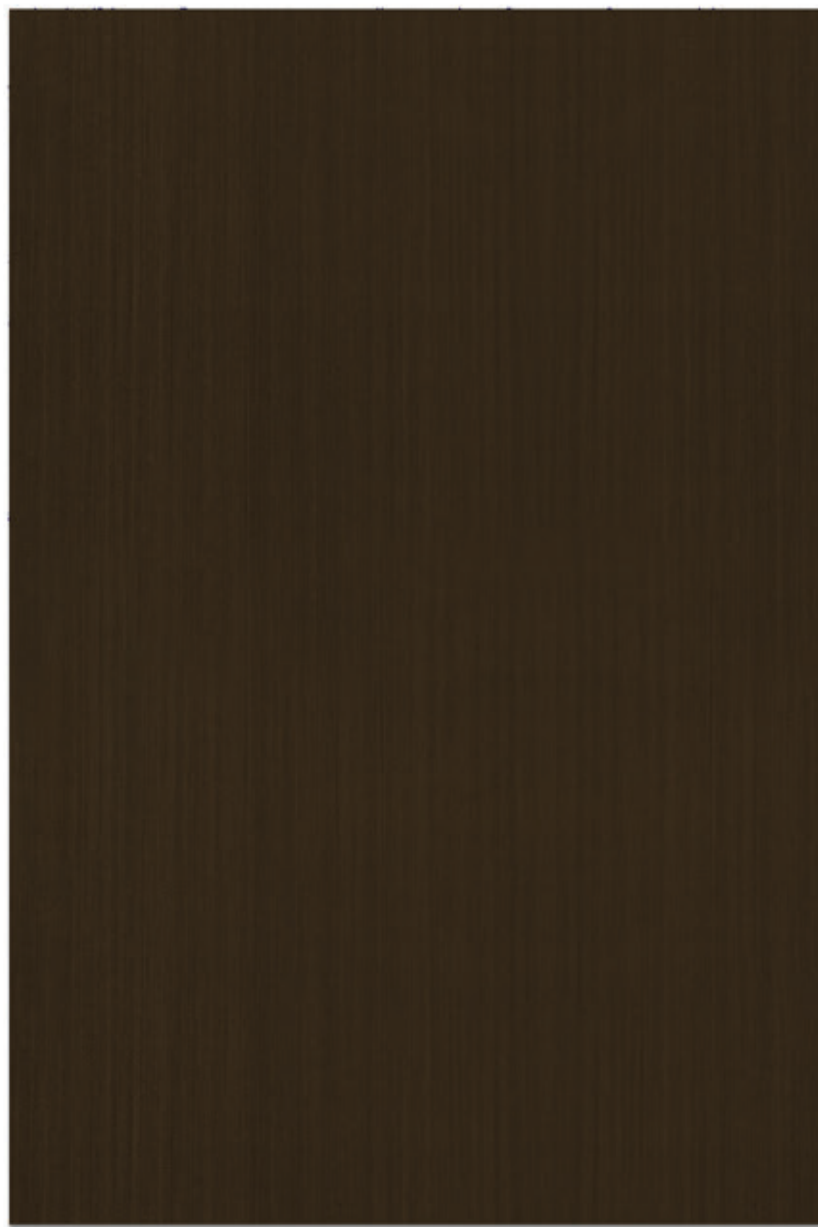

chocolate

Golden Powder Family



**B109-2420**  
2400Wx2000Dx750Hmm

**B109-2820**  
2800Wx2000Dx750Hmm

**B109-3620**  
3600Wx2000Dx750Hmm

**B109-2620**  
2600Wx2000Dx750Hmm

**B109-3220**  
3200Wx2000Dx750Hmm

**S109**  
3400Wx450Dx2100Hmm



**B126-1818**  
1800Wx1800Dx750Hmm

**B126-2218**  
2200Wx1800Dx750Hmm

**S106**  
2800Wx420Dx2100Hmm



**B126-2018**  
2000Wx1800Dx750Hmm

**B126-2418**  
2400Wx1800Dx750Hmm





**FUNCTIONSMITH, INC.**  
MANILA • GUANGZHOU

**B106-2020**  
2000Wx2000Dx750Hmm

**B106-2220**  
2200Wx2000Dx750Hmm

**B106-2420**  
2400Wx2000Dx750Hmm

**B106-2620**  
2600Wx2000Dx750Hmm

**S106**  
2800Wx400Dx2000Hmm

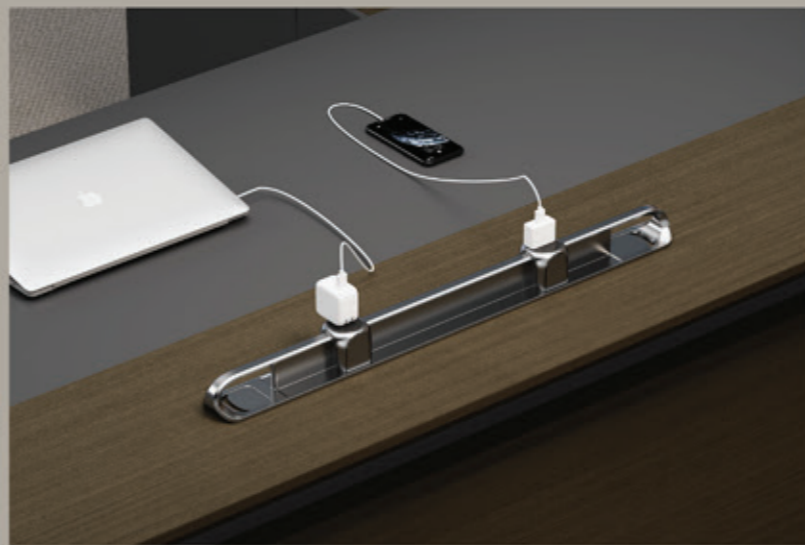



**FUNCTIONSMITH, INC.**  
MANILA • GUANGZHOU

**H13-3213**  
3200Wx1300Dx750Hmm

**H13-3615**  
3600Wx1500Dx750Hmm

**H13-4516**  
4500Wx1600Dx750Hmm

**H13-4816**  
4800Wx1600Dx750Hmm

**H13-6018**  
6000Wx1800Dx750Hmm



**S109-34**  
3400Wx450Dx2100Hmm



**S106**  
2800Wx400Dx2100Hmm

**FUNCTIONSMITH, INC.**  
MANILA • GUANGZHOU



**C805-1407**  
1400Wx700Dx450Hmm



**C805-0707**  
700Wx700Dx450Hmm

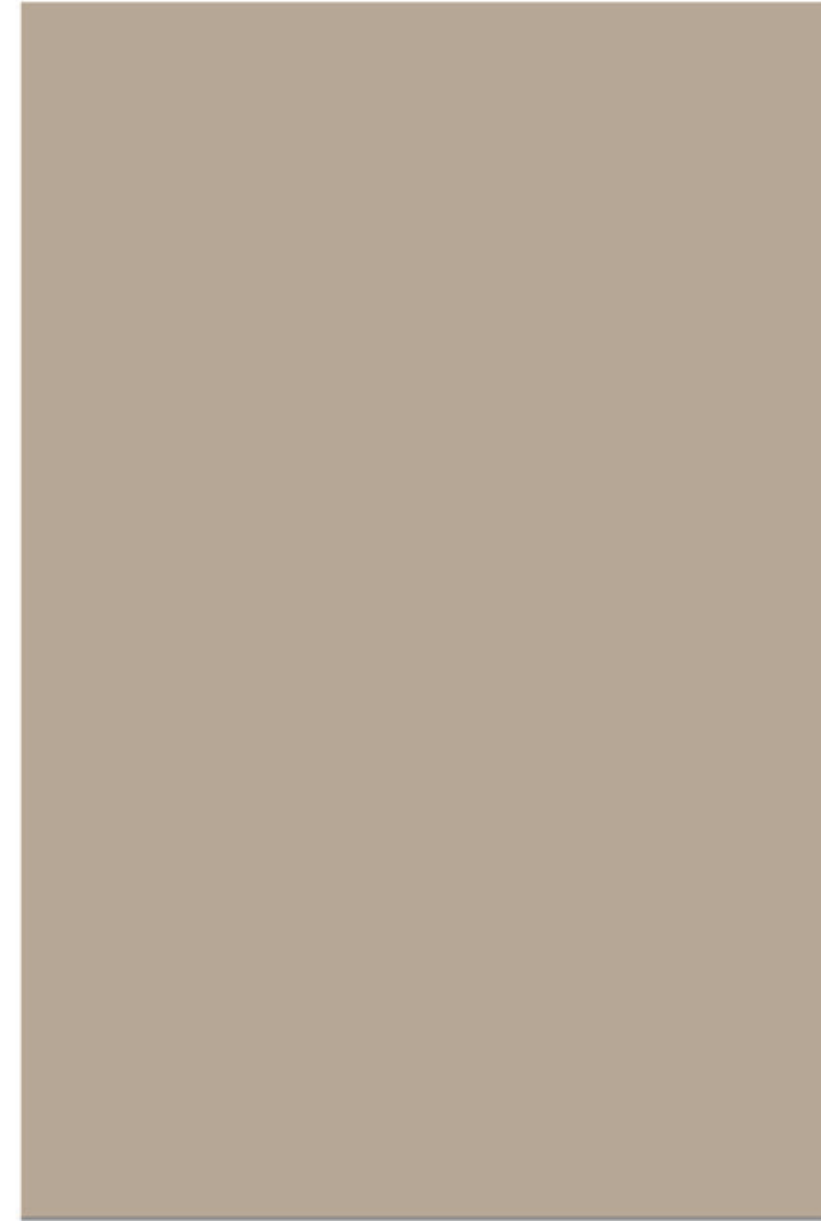

khaki



shadow





FUNCTIONSMITH, INC.  
MANILA • GUANGZHOU

**B101-2222**  
2200Wx2200Dx760Hmm

**B101-2422**  
2400Wx2200Dx760Hmm

**B101-2622**  
2600Wx2200Dx760Hmm

**S101-36**  
3600Wx400Dx2100Hmm



**B105-2221**  
2200Wx2100Dx750Hmm

**B105-2621**  
2600Wx2100Dx750Hmm

**B105-3221**  
3200Wx2100Dx750Hmm

**B105-2421**  
2400Wx2100Dx750Hmm

**B105-2821**  
2800Wx2100Dx750Hmm

**S105**  
3400Wx400Dx2000Hmm



**B103-1616**  
1600Wx1600Dx750Hmm

**B103-2016**  
2000Wx1600Dx750Hmm

**B103-2416**  
2400Wx1600Dx750Hmm

**B103-1816**  
1800Wx1600Dx750Hmm

**B103-2216**  
2200Wx1600Dx750Hmm

**S103-24**  
2400Wx400Dx2000Hmm



**FUNCTIONSMITH, INC.**  
MANILA • GUANGZHOU



**FUNCTIONSMITH, INC.**  
MANILA • GUANGZHOU



**B115-1616**  
1600Wx1600Dx750Hmm

**B115-2016**  
2000Wx1600Dx750Hmm

**B115-1816**  
1800Wx1600Dx750Hmm

**S115-24**  
2400Wx400Dx2000Hmm



**SJ123-1816**  
1800Wx1600Dx750Hmm

**S115-24**  
2400Wx400Dx2000Hmm



**H101-2812**  
2800Wx1200Dx750Hmm

**H101-3614**  
3600Wx1400Dx750Hmm

**H101-4816**  
4800Wx1600Dx750Hmm

**H101-3212**  
3200Wx1200Dx750Hmm

**H101-4516**  
4500Wx1600Dx750Hmm

**H101-6018**  
6000Wx1800Dx750Hmm







**FUNCTIONSMITH, INC.**  
MANILA • GUANGZHOU

**Z11-3206**  
3120Wx600Dx940Hmm

**Z11-1506**  
1560Wx600Dx940Hmm

**Z11-1506**  
1560Wx600Dx940Hmm





**Z11-3212**  
3120Wx1200Dx940Hmm

**Z11-1612**  
1560Wx1200Dx940Hmm

**Z11-1612**  
1560Wx1200Dx940Hmm



**Z11-4312**  
4320Wx1200Dx940Hmm



Z11-1506  
1560Wx600Dx940Hmm



Z11-1506  
1560Wx600Dx940Hmm



S105  
3400Wx400Dx2000Hmm



S101-36  
3600Wx400Dx2100Hmm



Z11-3206  
3120Wx600Dx940Hmm



S103-24  
2400Wx400Dx2000Hmm



S115-24  
2400Wx400Dx2000Hmm



E010  
1000Wx1000Dx750Hmm



Jinsiyu

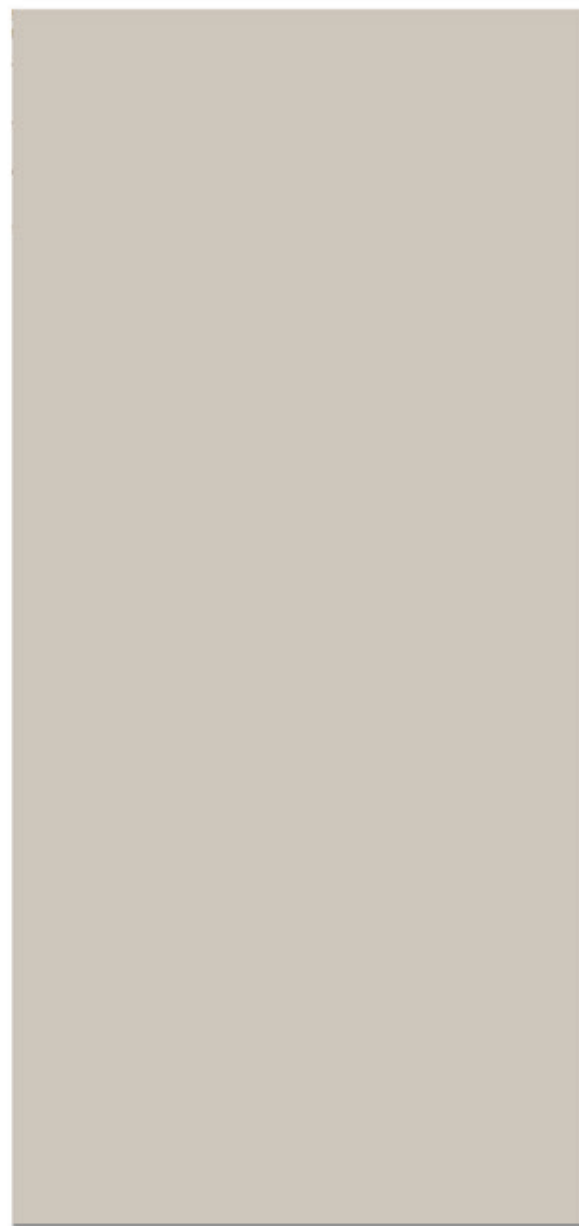

khaki



Louis



**FUNCTIONSMITH, INC.**  
MANILA • GUANGZHOU

**B610-2820**  
2800Wx2000Dx750Hmm

**B610-3220**  
3200Wx2000Dx750Hmm

**S610-34**  
3400Wx400Dx2000Hmm



**FUNCTIONSMITH, INC.**  
MANILA • GUANGZHOU

**B617-2018**  
2000Wx1800Dx750Hmm

**B617-2418**  
2400Wx1800Dx750Hmm

**B617-2218**  
2200Wx1800Dx750Hmm

**B617-2618**  
2600Wx1800Dx750Hmm

**S619**  
2400Wx400Dx2000Hmm





**B611-2018**  
2000Wx1800Dx750Hmm

**B611-2418**  
2400Wx1800Dx750Hmm

**S611-32**  
3200Wx400Dx2000Hmm

**B611-2218**  
2200Wx1800Dx750Hmm

**B611-2618**  
2600Wx1800Dx750Hmm



**B618-2420**  
2400Wx2000Dx750Hmm

**B618-2820**  
2800Wx2000Dx750Hmm

**B618-2620**  
2600Wx2000Dx750Hmm

**B618-3220**  
3200Wx2000Dx750Hmm

**S621**  
3000Wx400Dx2000Hmm



**B616-1816**  
1800Wx1600Dx750Hmm

**B616-2016**  
2000Wx1600Dx750Hmm

**S611-20**  
2000Wx400Dx2000Hmm



**B612-2018**  
2000Wx1800Dx750Hmm

**B612-2218**  
2200Wx1800Dx750Hmm

**B612-2418**  
2400Wx1800Dx750Hmm

**B612-2618**  
2600Wx1800Dx750Hmm

**S611-24**  
2400Wx400Dx2000Hmm





**B615-1616**  
1600Wx1600Dx750Hmm

**B615-1816**  
1800Wx1600Dx750Hmm

**B615-2016**  
2000Wx1600Dx750Hmm

**S616-24**  
2400Wx400Dx2000Hmm



**H61-2412**  
2400Wx1200Dx750Hmm

**H61-3614**  
3600Wx1400Dx750Hmm

**H61-4816**  
4800Wx1600Dx750Hmm

**H61-2812**  
2800Wx1200Dx750Hmm

**H61-4015**  
4000Wx1500Dx750Hmm

**H61-6018**  
6000Wx1800Dx750Hmm

**H61-3212**  
3200Wx1200Dx750Hmm

**H61-4516**  
4500Wx1600Dx750Hmm







**H09-2412**  
2400Wx1200Dx750Hmm

**H09-2813**  
2800Wx1300Dx750Hmm

**H09-3213**  
3200Wx1300Dx750Hmm

**H09-3615**  
3600Wx1500Dx750Hmm

**H09-4015**  
4000Wx1500Dx750Hmm

**H09-4516**  
4500Wx1600Dx750Hmm

**H09-4816**  
4800Wx1600Dx750Hmm

**H09-6018**  
6000Wx1800Dx750Hmm



**H66-2012**  
2000Wx1200Dx750Hmm

**H66-2412**  
2400Wx1200Dx750Hmm

**H66-2812**  
2800Wx1200Dx750Hmm

**H66-3212**  
3200Wx1200Dx750Hmm



**Z66B-1212**  
1200Wx1200Dx750Hmm

**Z66C-1212**  
1200Wx1200Dx750Hmm

**Z66A-2412**  
2400Wx1200Dx750Hmm



**Z62-1612**  
1580Wx1200Dx1100Hmm

**Z62-1612**  
1580Wx1200Dx1100Hmm

**Z62-3212**  
3160Wx1200Dx1100Hmm



**D61-1206**  
1200Wx600Dx750Hmm



**Z60-1624**  
1600Wx2400Dx900Hmm



**S610-34**  
3400Wx400Dx2000Hmm

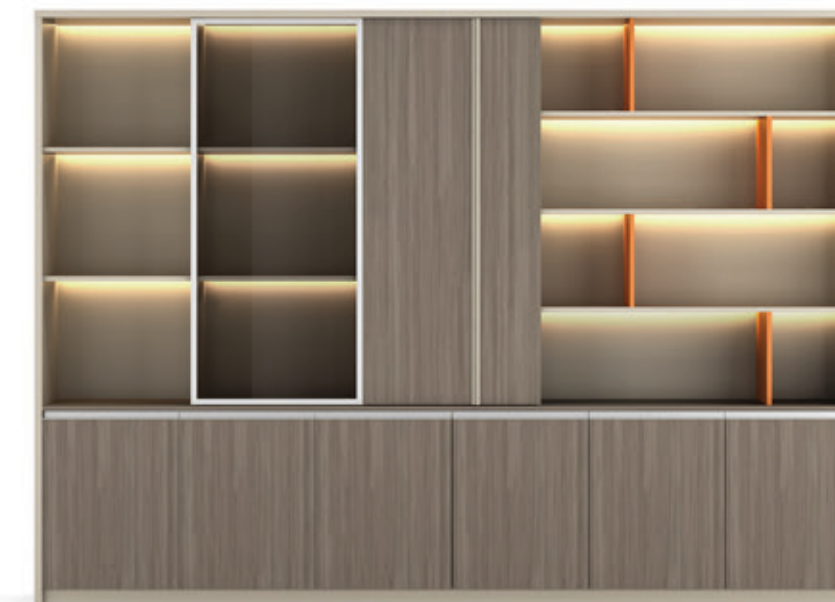

**S618**  
2800Wx400Dx2000Hmm



**S621**  
3000Wx400Dx2000Hmm



**S616-24**  
2400Wx400Dx2000Hmm



**S611-32**  
3200Wx400Dx2000Hmm



**S611-24**  
2400Wx400Dx2000Hmm



**S811-3**  
1200Wx400Dx2000Hmm

**S811-2**  
800Wx400Dx2000Hmm



**S619**  
2400Wx400Dx2000Hmm



**S611-20**  
2000Wx400Dx2000Hmm



**A26-2**  
800Wx400Dx800Hmm



**A26-3**  
1200Wx400Dx800Hmm



**A62-1610**  
1600Wx400Dx1000Hmm

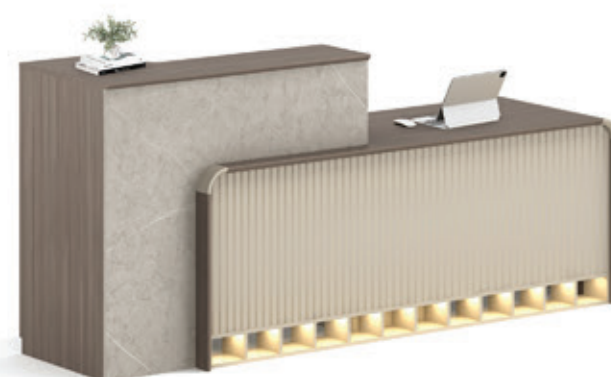

**Q09-2408**  
2400Wx770Dx1100Hmm



**Q09-2808**  
2800Wx770Dx1100Hmm

**Q09-3208**  
3200Wx770Dx1100Hmm



**C61-0606**  
600Wx600Dx450Hmm

**C61-0707**  
700Wx700Dx450Hmm



**C845-0606**  
600Wx600Dx450Hmm

**C845-0707**  
700Wx700Dx450Hmm



**C845-1206**  
1200Wx600Dx450Hmm

**C845-1407**  
1400Wx700Dx450Hmm



**C61-1206**  
1200Wx600Dx450Hmm

**C61-1407**  
1400Wx700Dx450Hmm



Purple

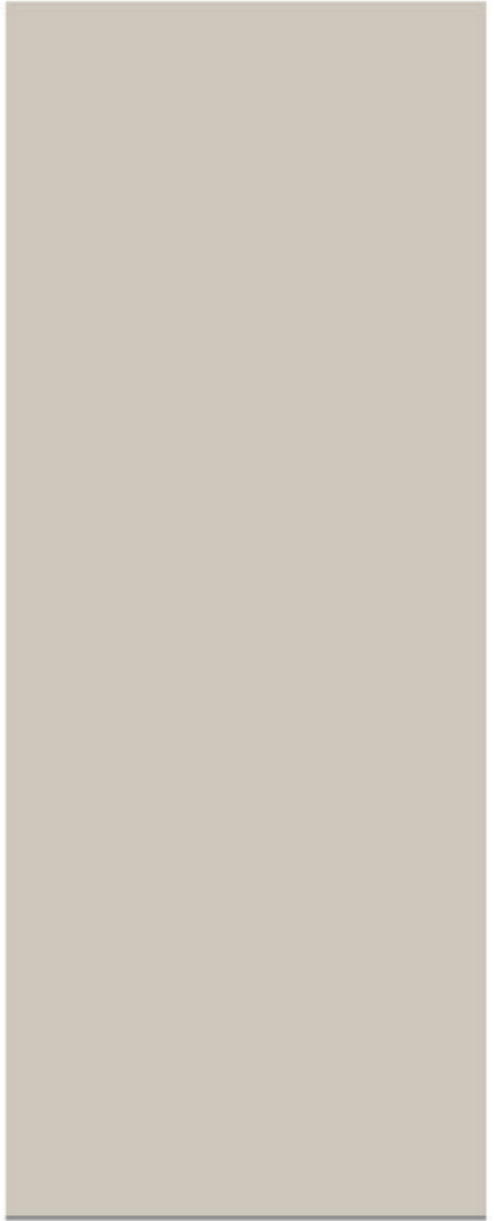

khaki



blackstone



Whitestone



**B910-2820**  
2800Wx2000Dx750Hmm

**B910-3220**  
3200Wx2000Dx750Hmm

**B910-3620**  
3600Wx2000Dx750Hmm

**S917**  
3200Wx400Dx2000Hmm  
3600Wx400Dx2000Hmm

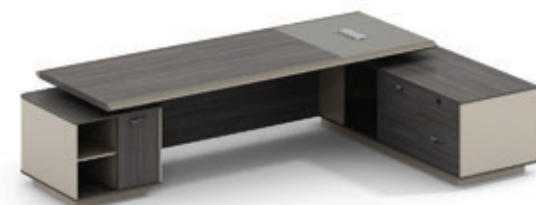

**B905-2820**  
2800Wx2000Dx750Hmm

**S905**  
3200Wx400Dx2000Hmm  
3700Wx400Dx2000Hmm

**B905-3220**  
3200Wx2000Dx750Hmm

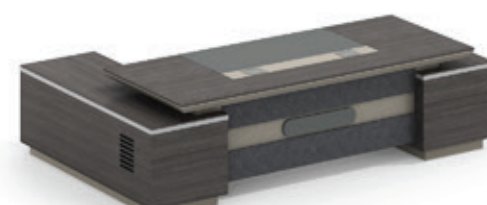



**B937B-2620**  
2600Wx2000Dx750Hmm

**B937B-3020**  
3000Wx2000Dx750Hmm

**S901C**  
3600Wx400Dx2000Hmm

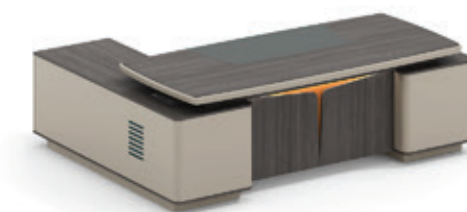
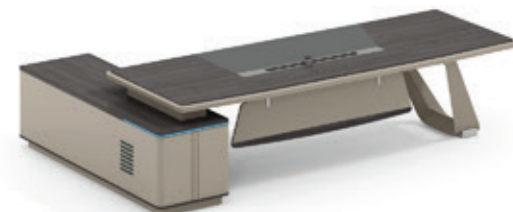
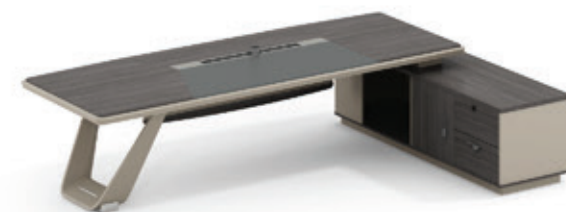

**B908-2418**  
2400Wx1800Dx750Hmm

**B908-2818**  
2800Wx1800Dx750Hmm

**B908-2618**  
2600Wx1800Dx750Hmm

**S912**  
3200Wx400Dx2000Hmm



**B912-2620**  
2600Wx2000Dx750Hmm

**B912-3020**  
3000Wx2000Dx750Hmm

**S906**  
3500Wx400Dx2000Hmm

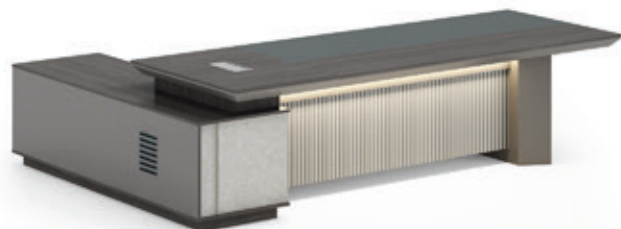

**B917-2218**  
2200Wx1800Dx750Hmm

**B917-2618**  
2600Wx1800Dx750Hmm

**B917-2418**  
2400Wx1800Dx750Hmm

**S918**  
3000Wx400Dx2000Hmm

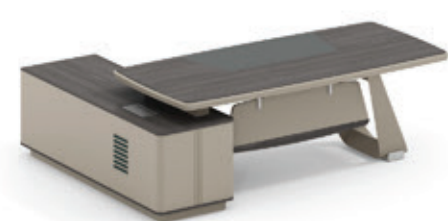





**B849-2017**  
2000Wx1700Dx750Hmm

**B849-2419**  
2400Wx1900Dx750Hmm

**S849-24**  
2400Wx400Dx2000Hmm



**B918-2018**  
2000Wx1800Dx750Hmm

**B918-2218**  
2200Wx1800Dx750Hmm

**S926**  
2400Wx400Dx2000Hmm

**B918-2418**  
2400Wx1800Dx750Hmm

**B918-2618**  
2600Wx1800Dx750Hmm

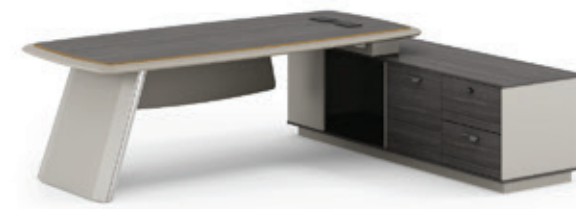



**B959-2018**  
2000Wx1800Dx750Hmm

**B959-2218**  
2200Wx1800Dx750Hmm

**S849-24**  
2400Wx400Dx2000Hmm

**B959-2418**  
2400Wx1800Dx750Hmm

**B959-2618**  
2600Wx1800Dx750Hmm

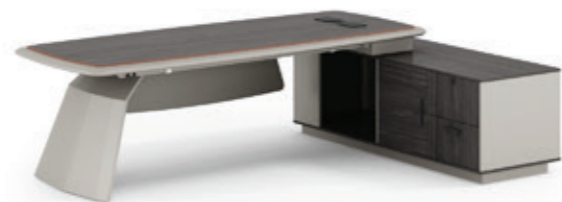

**B929-1816**  
1800Wx1600Dx750Hmm

**S926-24**  
2400Wx400Dx2000Hmm

**B929-2016**  
2000Wx1600Dx750Hmm



**FUNCTIONSMITH, INC.**  
MANILA • GUANGZHOU

**B957-2018**  
2000Wx1800Dx750Hmm

**B957-2218**  
2200Wx1800Dx750Hmm

**S849-24**  
2400Wx400Dx2000Hmm

**B957-2418**  
2400Wx1800Dx750Hmm

**B957-2618**  
2600Wx1800Dx750Hmm

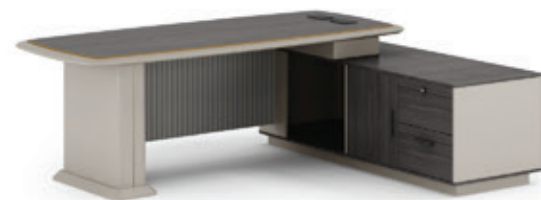

**FUNCTIONSMITH, INC.**  
MANILA • GUANGZHOU

**B958-2018**  
2000Wx1800Dx750Hmm

**B958-2218**  
2200Wx1800Dx750Hmm

**S838-24**  
2400Wx400Dx2000Hmm

**B958-2418**  
2400Wx1800Dx750Hmm

**B958-2618**  
2600Wx1800Dx750Hmm

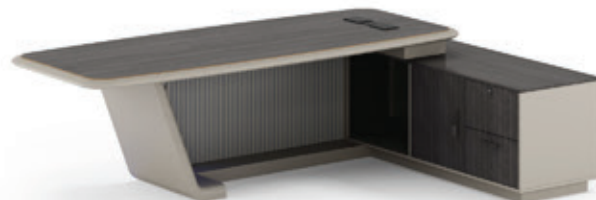
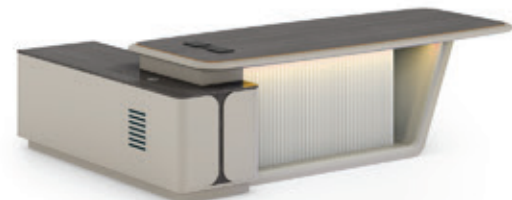



**FUNCTIONSMITH, INC.**  
MANILA • GUANGZHOU

**B923-1816**  
1800Wx1600Dx750Hmm

**B923-2018**  
2000Wx1800Dx750Hmm

**B923-2218**  
2200Wx1800Dx750Hmm

**B923-2418**  
2400Wx1800Dx750Hmm

**S849-24**  
2400Wx400Dx2000Hmm



**FUNCTIONSMITH, INC.**  
MANILA • GUANGZHOU

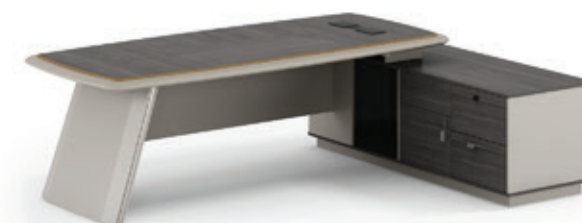

**B919-2018**  
2000Wx1800Dx750Hmm

**B919-2218**  
2200Wx1800Dx750Hmm

**B919-2418**  
2400Wx1800Dx750Hmm

**S918**  
3000Wx400Dx2000Hmm



**B822-1816**  
1800Wx1600Dx750Hmm

**B822-2418**  
2400Wx1800Dx750Hmm

**B822-2016**  
2000Wx1600Dx750Hmm



**B809F-1608**  
1600Wx800Dx750Hmm

**B809F-2009**  
2000Wx900Dx750Hmm

**B809F-1808**  
1800Wx800Dx750Hmm





**B920-1616**  
1600Wx1600Dx750Hmm

**B920-1816**  
1800Wx1600Dx750Hmm

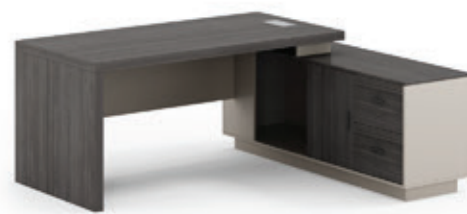

**B930-1614**  
1600Wx1400Dx750Hmm

**B930-1814**  
1800Wx1400Dx750Hmm

**B930-2014**  
2000Wx1400Dx750Hmm





**H07-3213**  
3200Wx1300Dx750Hmm

**H07-4816**  
4800Wx1600Dx750Hmm

**H07-3615**  
3600Wx1500Dx750Hmm

**H07-6018**  
6000Wx1800Dx750Hmm

**H07-4516**  
4500Wx1600Dx750Hmm

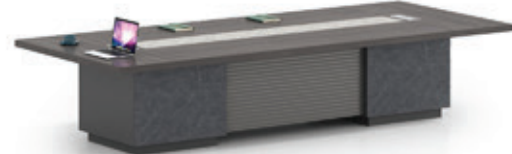
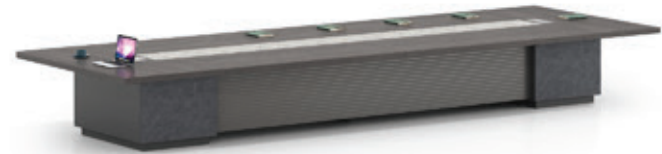

**H09-2412**  
2400Wx1200Dx750Hmm

**H09-3615**  
3600Wx1500Dx750Hmm

**H09-4816**  
4800Wx1600Dx750Hmm

**H09-2813**  
2800Wx1300Dx750Hmm

**H09-4015**  
4000Wx1500Dx750Hmm

**H09-6018**  
6000Wx1800Dx750Hmm

**H09-3213**  
3200Wx1300Dx750Hmm

**H09-4516**  
4500Wx1600Dx750Hmm



**H20-3615**  
3600Wx1500Dx750Hmm

**H20-4516**  
4500Wx1600Dx750Hmm

**H20-4816**  
4800Wx1600Dx750Hmm

**H20-6018**  
6000Wx1800Dx750Hmm



**FUNCTIONSMITH, INC.**  
MANILA • GUANGZHOU

**H13-3213**  
3200Wx1300Dx750Hmm

**H13-4816**  
4800Wx1600Dx750Hmm

**H13-3615**  
3600Wx1500Dx750Hmm

**H13-6018**  
6000Wx1800Dx750Hmm

**H13-4516**  
4500Wx1600Dx750Hmm







**H959-2412**  
2400Wx1200Dx750Hmm

**H959-3615**  
3600Wx1500Dx750Hmm

**H959-4816**  
4800Wx1600Dx750Hmm

**H959-2812**  
2800Wx1200Dx750Hmm

**H959-4015**  
4000Wx1500Dx750Hmm

**H959-6018**  
6000Wx1800Dx750Hmm

**H959-3212**  
3200Wx1200Dx750Hmm

**H959-4516**  
4500Wx1600Dx750Hmm



**H11-2812**  
2800Wx1200Dx750Hmm

**H11-4816**  
4800Wx1600Dx750Hmm

**H11-3212**  
3200Wx1200Dx750Hmm

**H11-4516**  
4500Wx1600Dx750Hmm

**H11-3614**  
3600Wx1400Dx750Hmm



**H25-2412**  
2400Wx1200Dx750Hmm

**H25-2812**  
2800Wx1200Dx750Hmm

**H25-3212**  
3200Wx1200Dx750Hmm

**H25-3614**  
3600Wx1400Dx750Hmm

**H25-4516**  
4500Wx1600Dx750Hmm

**H25-4816**  
4800Wx1600Dx750Hmm

**H25-6018**  
6000Wx1800Dx750Hmm



**H930-1608**  
1600Wx800Dx750Hmm

**H930-2010**  
2000Wx1000Dx750Hmm

**H930-1808**  
1800Wx850Dx750Hmm

**H930-2212**  
2200Wx1200Dx750Hmm



**H930-2412**  
2400Wx1200Dx750Hmm

**H930-3212**  
3200Wx1200Dx750Hmm

**H930-2812**  
2800Wx1200Dx750Hmm

**H930-3612**  
3600Wx1200Dx750Hmm





**Z89-1612** 1600Wx1200Dx900Hmm  
**Z89-2812** 2800Wx1200Dx900Hmm  
**Z89-3212** 3200Wx1200Dx900Hmm  
**Z89-4812** 4800Wx1200Dx900Hmm  
**Z67-1528** 1500Wx2800Dx1100Hmm  
**Z95-1512** 1520Wx1200Dx1100Hmm



**Z68-1406** 1400Wx600Dx750Hmm  
**Z68-1424** 1400Wx2400Dx750Hmm  
**Z68-1412** 1400Wx1200Dx750Hmm  
**Z68-2612** 2600Wx1200Dx750Hmm  
**Z68-3812** 3800Wx1200Dx750Hmm



**S912**  
3200Wx400Dx2000Hmm



**S849-30**  
3000Wx400Dx2000Hmm



**S849-24**  
2400Wx400Dx2000Hmm



**S905**  
3200Wx400Dx2000Hmm  
3700Wx400Dx2000Hmm



**S917**  
3200Wx400Dx2000Hmm  
3600Wx400Dx2000Hmm



**S901A**  
3430Wx400Dx2000Hmm



**S901B**  
2630Wx400Dx2000Hmm



**S918-24**  
2400Wx400Dx2000Hmm



**S918-30**  
3000Wx400Dx2000Hmm



**S838-24**  
2400Wx400Dx2000Hmm



**S926-24**  
2400Wx400Dx2000Hmm



**S929A**  
2400Wx400Dx2000Hmm



**S929B**  
2000Wx400Dx2000Hmm



**S811-3**      **S811-2**      **S811-3**  
1200Wx400Dx2000Hmm    800Wx400Dx2000Hmm    1200Wx400Dx2000Hmm



**A4716**  
1600Wx400Dx1150Hmm



**A4808**  
800Wx400Dx800Hmm



**A4908**  
800Wx400Dx1150Hmm



**A4312**  
1200Wx400Dx850Hmm



**S902-2**  
800Wx400Dx2000Hmm



**S902-3**  
1200Wx400Dx2000Hmm



**S902-4**  
1600Wx400Dx2000Hmm



**S902-5**  
2000Wx400Dx2000Hmm



**A4512**  
1200Wx400Dx1200Hmm



**A26-2**  
800Wx400Dx800Hmm



**A26-3**  
1200Wx400Dx800Hmm



**A20-1**  
400Wx420Dx600Hmm



**A20-2**  
400Wx420Dx600Hmm



**C805-1407**  
1400Wx700Dx450Hmm

**C805-0707**  
700Wx700Dx450Hmm



**C842-1206**  
1200Wx600Dx450Hmm

**C842-0606**  
600Wx600Dx450Hmm



**C841-1206**  
1200Wx600Dx450Hmm

**C841-1407**  
1400Wx700Dx450Hmm

**C841-0606**  
600Wx600Dx450Hmm

**C841-0707**  
700Wx700Dx450Hmm



**C843-0606**  
600Wx600Dx450Hmm

**C843-0707**  
700Wx700Dx450Hmm



**C843-1206**  
1200Wx600Dx450Hmm

**C843-1407**  
1400Wx700Dx450Hmm



**C845-0606**  
600Wx600Dx450Hmm

**C845-0707**  
700Wx700Dx450Hmm



**C845-1206**  
1200Wx600Dx450Hmm

**C845-1407**  
1400Wx700Dx450Hmm



**Q05-2407**  
2400Wx700Dx1050Hmm

**Q05-2807**  
2800Wx700Dx1050Hmm



Camphor



Whitestone



khaki



**S937**  
2400Wx400Dx2000Hmm

**S927**  
2000Wx400Dx2000Hmm



**B979-1616**  
1600Wx1600Dx750Hmm

**B979-1816**  
1800Wx1600Dx750Hmm

**B979-2016**  
2000Wx1600Dx750Hmm

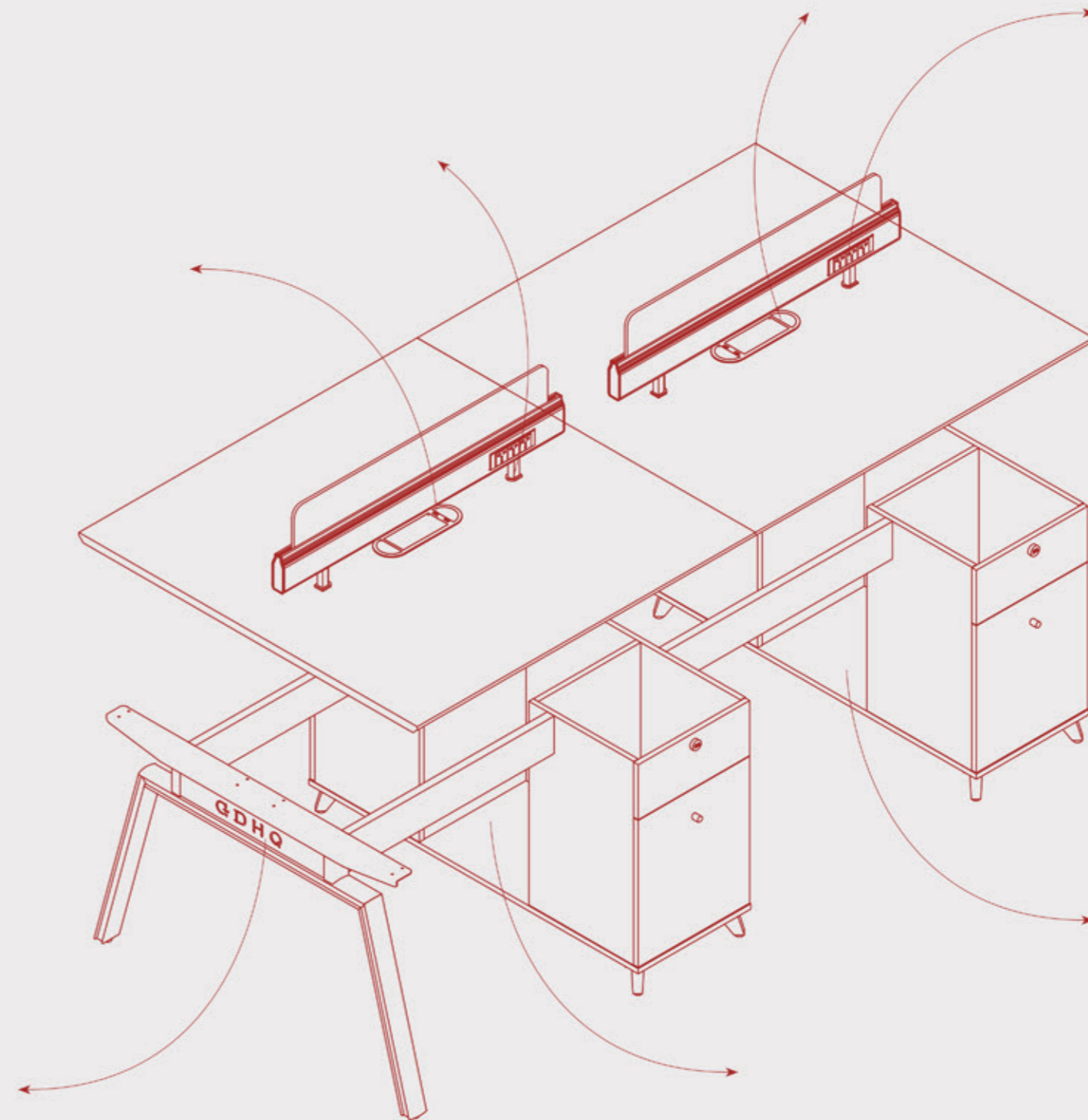





**FUNCTIONSMITH, INC.**  
MANILA • GUANGZHOU



**FUNCTIONSMITH, INC.**  
MANILA • GUANGZHOU



**Z99A**  
2400Wx1200Dx750Hmm



**Z99B**  
1200Wx1200Dx750Hmm



**Z99C**  
1200Wx1200Dx750Hmm



**Z99-1206**  
1200Wx600Dx750Hmm



**Z96-1624**  
1600Wx2400Dx1100Hmm



**FUNCTIONSMITH, INC.**  
MANILA • GUANGZHOU

**Z96-1624**  
1600Wx2400Dx1100Hmm



**FUNCTIONSMITH, INC.**  
MANILA • GUANGZHOU



**Z99A**  
2400Wx1200Dx750Hmm



**Z99B**  
1200Wx1200Dx750Hmm



**Z99C**  
1200Wx1200Dx750Hmm



**Z99-1206**  
1200Wx600Dx750Hmm



**FUNCTIONSMITH, INC.**  
MANILA • GUANGZHOU

122

**H97-2812**  
2800Wx1200Dx750Hmm

**H97-3212**  
3200Wx1200Dx750Hmm

**H97-3612**  
3600Wx1200Dx750Hmm



**FUNCTIONSMITH, INC.**  
MANILA • GUANGZHOU

123

**A1209**  
1200Wx400Dx900Hmm



**H97-2412**  
2400Wx1200Dx750Hmm



chocolate

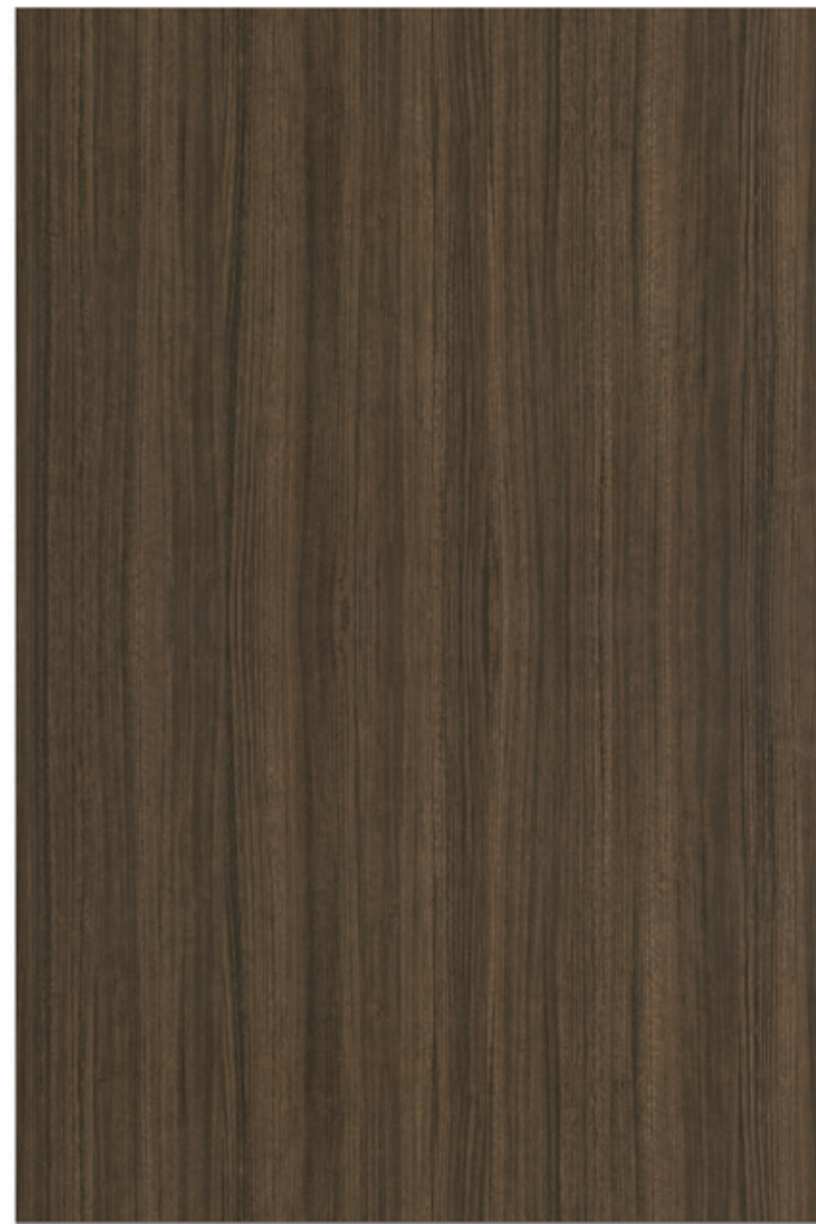

Ebony Wood



**B816-2620**  
2600Wx2000Dx750Hmm

**B816-3220**  
3200Wx2000Dx750Hmm

**S816**  
3500Wx400Dx2000Hmm



**B808-2820**  
2800Wx2000Dx750Hmm

**B808-3220**  
3200Wx2000Dx750Hmm

**S808**  
3500Wx450Dx2000Hmm

126

127



**FUNCTIONSMITH, INC.**  
MANILA • GUANGZHOU

**B820-2018**  
2000Wx1800Dx750Hmm

**B820-2418**  
2400Wx1800Dx750Hmm

**S810**  
2400Wx400Dx2000Hmm



**FUNCTIONSMITH, INC.**  
MANILA • GUANGZHOU

**B818-2618**  
2600Wx1800Dx750Hmm

**S818**  
3100Wx400Dx2000Hmm



**B823-1616**  
1600Wx1600Dx750Hmm

**B823-1816**  
1800Wx1600Dx750Hmm

**B823-2016**  
2000Wx1600Dx750Hmm

**S811-2**  
800Wx400Dx2000Hmm

**S811-3**  
1200Wx400Dx2000Hmm



**B815-2418**  
2400Wx1800Dx750Hmm

**B815-2018**  
2000Wx1800Dx750Hmm

**S815**  
2400Wx400Dx2000Hmm



**B809F-1608**  
1600Wx800Dx750Hmm



**B809F-1808**  
1800Wx800Dx750Hmm

**B809F-2009**  
2000Wx900Dx750Hmm



**D06-1206**  
1200Wx600Dx750Hmm

**D06-1406**  
1400Wx600Dx750Hmm



**D05-1406**  
1400Wx600Dx750Hmm



**D35-1407**  
1400Wx700Dx750Hmm



**Z98-1512**  
1500Wx1200Dx1100Hmm



**Z92-1206**  
1200Wx600Dx750Hmm

**Z92-2412**  
2400Wx1200Dx750Hmm

**Z92-1212**  
1200Wx1200Dx750Hmm

**Z92-3612**  
3600Wx1200Dx750Hmm





D29-1607  
1600Wx750Dx750Hmm



D02-1407  
1400Wx700Dx750Hmm

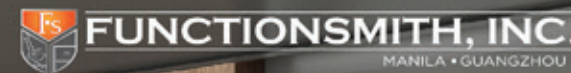

H15-2812  
2800Wx1200Dx750Hmm

H15-3212  
3200Wx1200Dx750Hmm

H15-3614  
3600Wx1400Dx750Hmm

H15-4516  
4500Wx1600Dx750Hmm

134

135



**H01-2813**  
2800Wx1300Dx750Hmm

**H01-3213**  
3200Wx1300Dx750Hmm

**H01-3615**  
3600Wx1500Dx750Hmm

**H01-4016**  
4000Wx1600Dx750Hmm

**H01-4516**  
4500Wx1600Dx750Hmm

**H01-4816**  
4800Wx1600Dx750Hmm

**H01-6018**  
6000Wx1800Dx750Hmm

**H01-8020**  
8000Wx2000Dx750Hmm



**Q03-2208**  
2200Wx750Dx1050Hmm

**Q03-2408**  
2400Wx750Dx1050Hmm

136

137



**Y01**  
700Wx500Dx1050Hmm



**Y02**  
4900Wx600Dx800Hmm



**T01-1204**  
1200Wx400Dx750Hmm



**T01-1404**  
1400Wx400Dx750Hmm



**S902-2**  
800Wx400Dx2000Hmm



**S902-3**  
1200Wx400Dx2000Hmm



**S902-4**  
1600Wx400Dx2000Hmm



**S902-5**  
2000Wx400Dx2000Hmm



**S811-3**  
1200Wx400Dx2000Hmm

**S811-2**  
800Wx400Dx2000Hmm

**S811-3**  
1200Wx400Dx2000Hmm



A4716  
1600Wx400Dx1150Hmm



A5508  
800Wx400Dx1200Hmm



A4908  
800Wx400Dx1150Hmm



A4808  
800Wx400Dx800Hmm



C805-1407  
1400Wx700Dx450Hmm



C805-0707  
700Wx700Dx450Hmm



A4208  
1000Wx400Dx850Hmm



A4312  
1200Wx400Dx850Hmm



A26-2  
800Wx400Dx800Hmm



A26-3  
1200Wx400Dx800Hmm



C841-1206  
1200Wx600Dx450Hmm



C841-0606  
600Wx600Dx450Hmm



C842-1206  
1200Wx600Dx450Hmm



C842-0606  
600Wx600Dx450Hmm

C841-1407  
1400Wx700Dx450Hmm

C841-0707  
700Wx700Dx450Hmm



**T102**

1200Wx400Dx750Hmm  
1200Wx600Dx750Hmm  
1400Wx400Dx750Hmm  
1400Wx600Dx750Hmm  
1600Wx400Dx750Hmm  
1600Wx600Dx750Hmm  
1800Wx400Dx750Hmm  
1800Wx600Dx750Hmm



**T211**

1200Wx400Dx750Hmm  
1200Wx600Dx750Hmm  
1400Wx400Dx750Hmm  
1400Wx600Dx750Hmm  
1600Wx400Dx750Hmm  
1600Wx600Dx750Hmm  
1800Wx400Dx750Hmm  
1800Wx600Dx750Hmm



**T206**

1200Wx400Dx750Hmm  
1200Wx600Dx750Hmm  
1400Wx400Dx750Hmm  
1400Wx600Dx750Hmm  
1600Wx400Dx750Hmm  
1600Wx600Dx750Hmm  
1800Wx400Dx750Hmm  
1800Wx600Dx750Hmm



**T203**

1200Wx400Dx750Hmm  
1200Wx600Dx750Hmm  
1400Wx400Dx750Hmm  
1400Wx600Dx750Hmm  
1600Wx400Dx750Hmm  
1600Wx600Dx750Hmm  
1800Wx400Dx750Hmm  
1800Wx600Dx750Hmm



**T06-SJ**

1200Wx400Dx750Hmm  
1200Wx600Dx750Hmm  
1400Wx600Dx750Hmm  
1600Wx400Dx750Hmm  
1600Wx600Dx750Hmm  
1800Wx400Dx750Hmm  
1800Wx600Dx750Hmm



**T103**

1200Wx400Dx750Hmm  
1200Wx600Dx750Hmm  
1400Wx400Dx750Hmm  
1400Wx600Dx750Hmm  
1600Wx400Dx750Hmm  
1600Wx600Dx750Hmm  
1800Wx400Dx750Hmm  
1800Wx600Dx750Hmm





HQ-P699



HQ-P651



HQ-P610



HQ-P660



HQ-P912



HQ-P808



HQ-W928



HQ-W623A



HQ-W623B



HQ-W623B



HQ-P618A



HQ-W608B



HQ-P959



HQ-P701



HQ-P691A



HQ-P677A



HQ-P700A



HQ-P676



HQ-P687A



HQ-P687C



HQ-P683A



HQ-P628A



HQ-P628B



HQ-P803



HQ-S033

1130Wx850Dx850Hmm  
2130Wx850Dx850Hmm



HQ-S030

1300Wx880Dx850Hmm  
2350Wx880Dx850Hmm



HQ-S010

1080Wx880Dx880Hmm  
2080Wx880Dx880Hmm



HQ-S032

1100Wx880Dx780Hmm  
2200Wx880Dx780Hmm



HQ-S035 P 9833

1130Wx850Dx850Hmm  
2130Wx850Dx850Hmm



HQ-W026

1100Wx840Dx800Hmm  
2100Wx840Dx800Hmm



HQ-S031

1050Wx880Dx850Hmm  
2250Wx880Dx850Hmm

144

145