



五福專業建材

用好心、做傳承
為您打造優質的東方仿古生活



內政部建築研究所防火實驗中心

地址:711臺南市歸仁區六甲里中正南路1段2502號
電話:(06)2392755 傳真:(06)2392701



薄材料防焰性 試驗報告

試驗日期:104年5月4日
報告書編號:CNS-7614-10403

試片名稱:線板

委託編號:F0210403

委託單位:五福薄片行

1. 上項試片經本實驗中心試驗,報告含封面共10頁。
2. 使用本報告時須整份使用,分離使用無效,不得任意摘錄。
3. 本試驗報告僅對委託試驗試片負責。
4. 試片名稱、試片圖說、送樣人資料係由委託單位提供。
5. 本報告僅供參考,不得作為商業廣告或訴訟之用。
6. 委託單位僅得全文引用下列文字:「所標示之性能是由內政部建築研究所防火實驗中心,依據CNS 7614(1994)「薄材料防焰性試驗法」試驗所得」。不得分離其中「內政部建築研究所防火實驗中心」稱謂,在任何廣告、傳單或產品宣傳文件上使用。
7. 委託單位所送實驗中心試片與工法不得涉及第三者之智慧財產權。
8. 委託單位所申請技術服務項目不得涉及驗證第三者產品之目的,如因此涉及法律責任,本項申請試驗結果與報告書不得作為法律訴訟之依據。

防火實驗中心

防火實驗中心主管

中華民國 104 年 6 月 2 日

內政部建築研究所防火實驗中心
711臺南市歸仁區六甲里中正南路1段2502號
報告書編號:CNS-7614-10403
頁次:第 3 頁,共 10 頁

一、加熱試驗結果紀錄表

試驗名稱		CNS 7614 薄材料防焰性試驗					
試片名稱		線板					
試驗日期		104年5月4日					
試驗資料	熱源	丁烷, 焰長 65 mm	試片尺寸	300 (長) mm × 200 (寬) mm			
	前置處理	將試片置於 50±2 °C 之烘箱內乾燥 48 小時, 其次置入放有乾燥用矽凝膠之玻璃乾燥器內 24 小時以上。					
試驗環境		室內溫度: 27.8 °C	室內相對濕度: 64 %				
試片編號	加熱面方向		試驗結果		備註		
	加熱時間	餘焰時間 (秒)	加熱完畢 1 分鐘後之餘燼時間(秒)	炭化長度 (cm)			
F0210403-1	正面	3 分鐘	0	0	3.4	—	
F0210403-2		3 分鐘	0	0	3.4	—	
F0210403-3		3 分鐘	0	0	3.4	—	
試片正面加熱時間 3 分鐘		試驗結果最大值		0	0	3.4	—
備註	本案委託申請以 CNS 7614 薄材料防焰性 3 分鐘加熱時間作加熱試驗。						
	1. 送測試片加熱時間 3 分鐘試驗結果最大值為餘焰時間 0 秒、加熱完畢 1 分鐘後之餘燼時間 0 秒、炭化長度 3.4 cm。 2. 送測試片試驗結果符合加熱時間 3 分鐘防焰 1 級判定基準。						
試驗操作人		報告簽署人					

內
建
防
火

新品上市 防焰線板

天然石膏

天然實木-松木

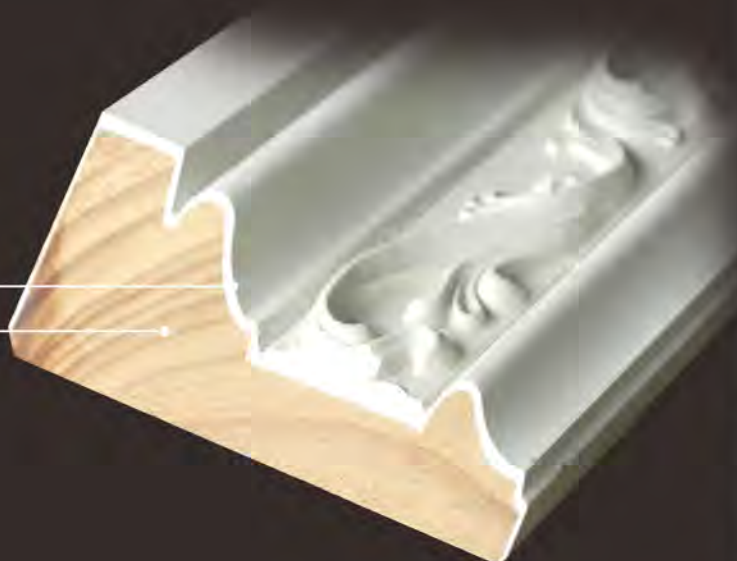



DL-8250 DL-8251 DL-8252 DL-8253 DL-8254

DL-8260



DL-8261



DL-8255 DL-8256 DL-8257 DL-8258 DL-8259



DL-8262 DL-8263 DL-8264 DL-8265 DL-8266



DL-8267

DL-8268

DL-8269

DL-8270

DL-8271



WF-A-7041



WF-A-7036



WF-A-7037



WF-A-7038



WF-A-7040



WF-029

WF-029-1

WF-029-2

WF-029-3

WF-029-5



WF-030

WF-030-1

WF-030-2

WF-030-3

WF-030-5

簡約造型板



WF-027-3



WF-028-3



WF-027-5



WF-028-5

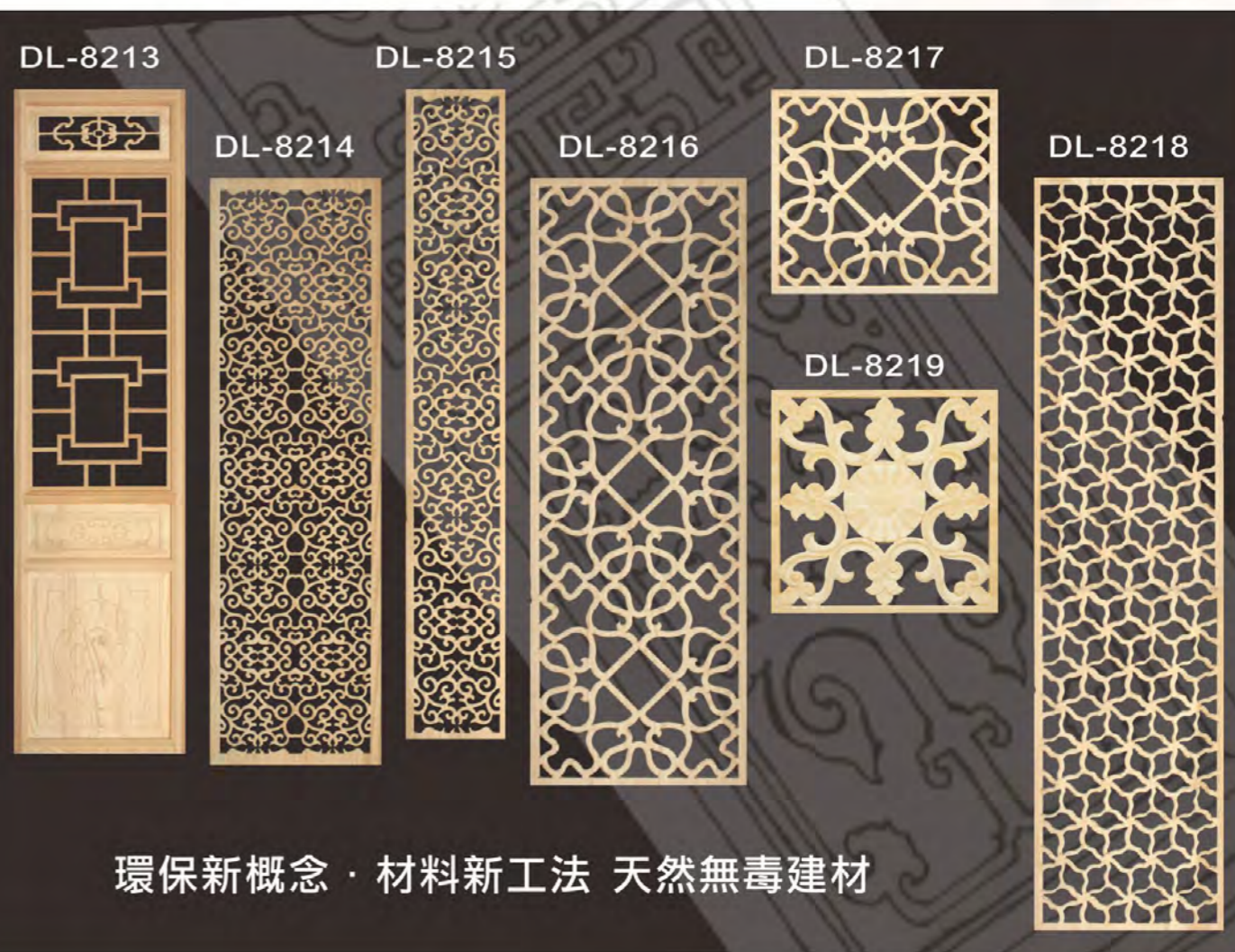
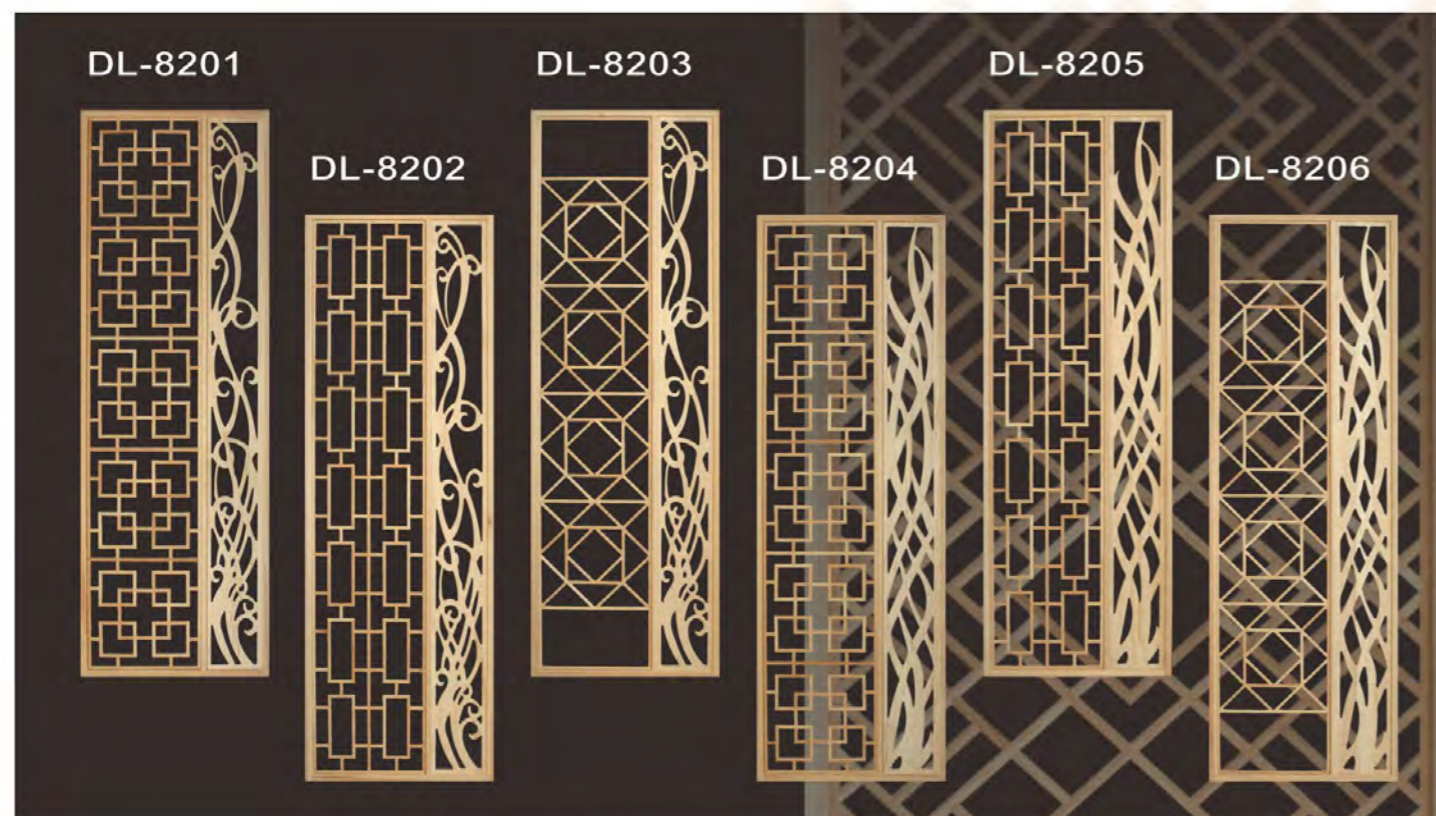
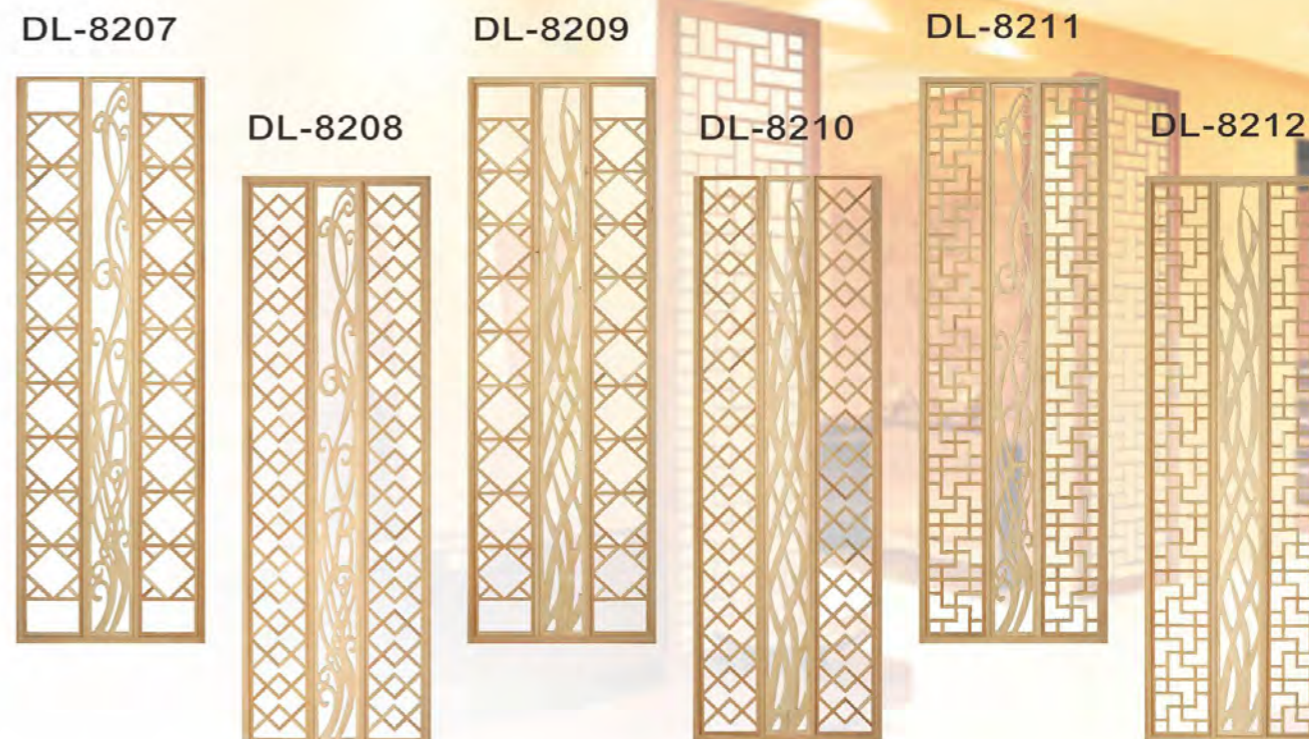

環保新概念 · 材料新工法 天然無毒建材

環保新概念 · 材料新工法 天然無毒建材

DL-8251 雙面雕花(台灣製)

尺寸：長 X 寬 X 厚
 廠規：273CM X 50CM X 3.6CM (±0.5CM)
 樹種：天然松木
 外框：面寬6cm 面厚 3.6cm
 內枳：面寬1.5cm 面厚 1.8cm

窗花空間的結構
 傳承中式的神韻和精髓
 手工藝傳承了歷史文化

時間造就歷史 古色古香的窗花
 看到先人注入現代裝修境界的美

接受訂製
 客製化

DL-8250 雙面雕花(台灣製)

尺寸：長 X 寬 X 厚
 廠規：242CM X 67CM X 3.6CM (±0.5CM)
 樹種：天然松木、不含油漆
 外框：面寬5.0cm 面厚 3.6cm
 內枳：面寬1.5cm 面厚 1.8cm



DL-8252 雙面雕花(台灣製)

尺寸：長 X 寬 X 厚
 廠規：273CM X 60CM X 3.6CM (±0.5CM)
 樹種：天然松木
 外框：面寬1.5cm 面厚 3.6cm
 內枳：面寬1.5cm 面厚 1.8cm

祥雲來
 福氣到

接受訂製
 客製化



DL-8253 雙面雕花(台灣製)

尺寸：長 X 寬 X 厚
 廠規：270CM X 60CM X 3.6CM (±0.5CM)
 樹種：天然松木
 外框：面寬5cm 面厚 3.6cm
 內枳：面寬1.5cm 面厚 1.8cm

西式花朵的美
 東方窗櫺的創意
 藝術美的結合

人造柚木



DL-8124

- 雙面窗花
- 尺寸：長X寬X厚
170X41.5X3.6CM±0.5CM
- 內線條尺寸：15X18mm
- 時尚簡約—四方榫
- 接受任合尺寸訂做
(不含油漆)

人造柚木

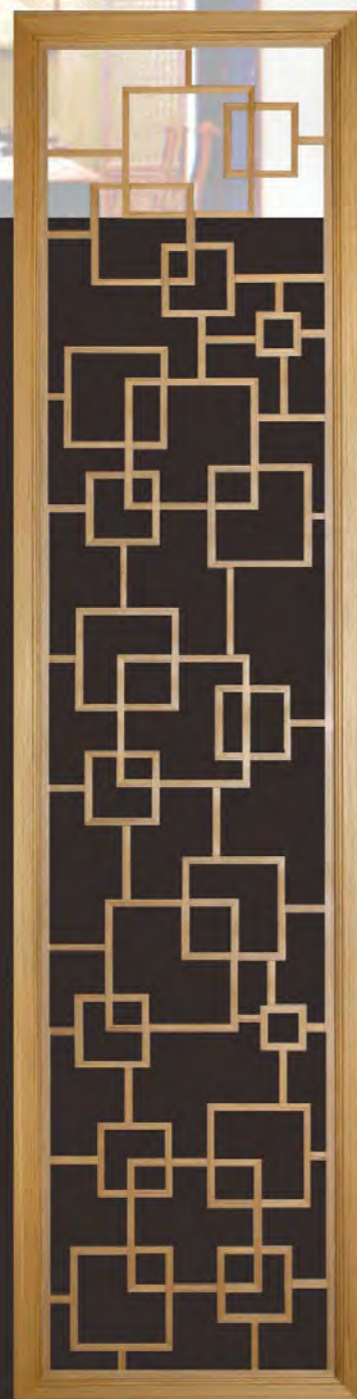

- 樹種
- A 天然樹種
- 1.松木 2.美檜 3.越檜 4.柚木
- B 人造樹種
- 1.人造柚木 2.人造胡桃
- 3.人造白橡



四方榫

DL-8125

- 雙面窗花
- 尺寸：長X寬X厚
240X60X3.6CM±0.5CM
- 內線條尺寸：15X18mm
- 時尚簡約—四方榫
- 接受任合尺寸訂做
(不含油漆)

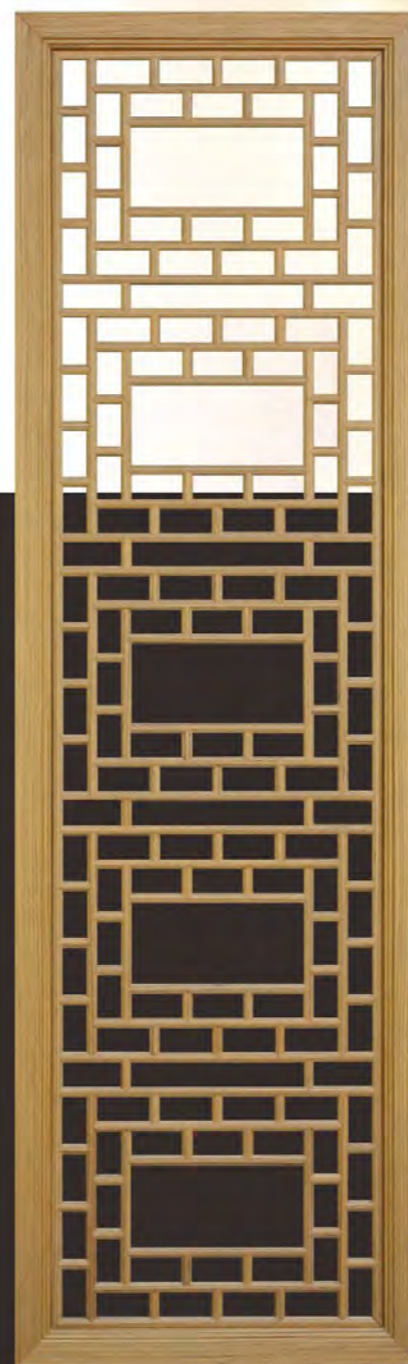

DL-8126

- 雙面窗花
- 尺寸：長X寬X厚
178X54X3.6CM±0.5CM
- 內線條尺寸：15X18mm
- 古藝技法—燕嘴榫
- 接受任合尺寸訂做
(不含油漆)

人造柚木



人造柚木



- 樹種
- A 天然樹種
- 1.松木 2.美檜 3.越檜 4.柚木
- B 人造樹種
- 1.人造柚木 2.人造胡桃
- 3.人造白橡



燕嘴榫

DL-8127

- 雙面窗花
- 尺寸：長X寬X厚
180X50X3.6CM±0.5CM
- 內線條尺寸：15X18mm
- 古藝技法—燕嘴榫
- 接受任合尺寸訂做
(不含油漆)

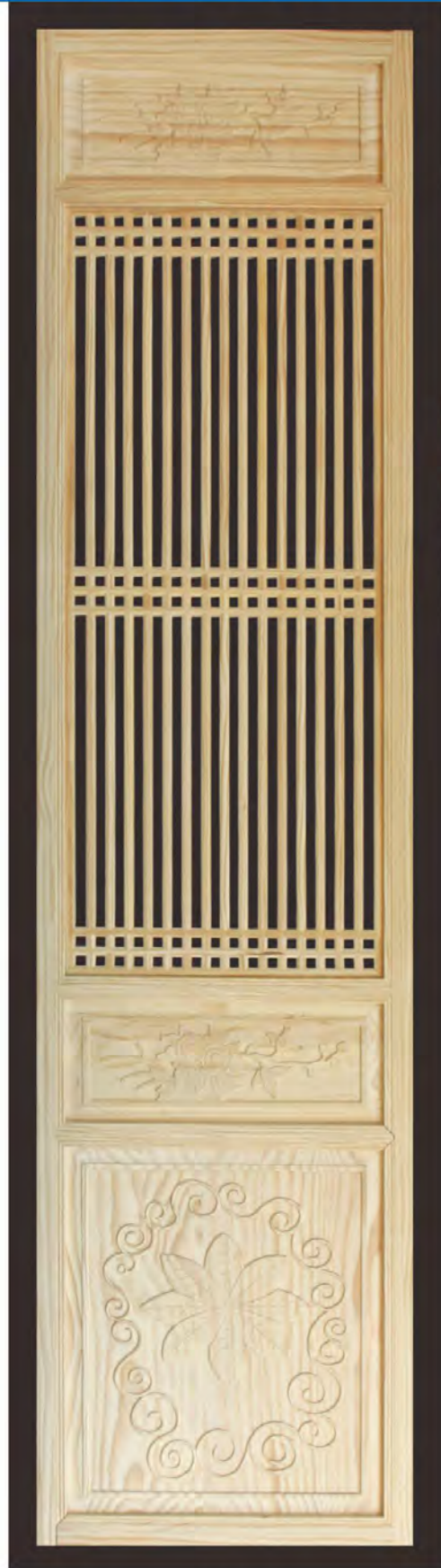

DL-8254 雙面雕花(台灣製)

尺寸：長 X 寬 X 厚
廠規：242CM X 60CM X 3.6CM (±0.5CM)
樹種：天然松木
外框：面寬5cm 面厚 3.6cm
內枳：面寬1.5cm 面厚 1.8cm

追求簡單要求 迎合中式追求內斂
質樸的設計底蘊更富現代感

把歐式融入於中式風格
文化包容一切的創新歐式肚板

接受訂製
客製化

DL-8255 雙面雕花(台灣製)
尺寸：長 X 寬 X 厚
廠規：242CM X 60CM X 3.6CM (±0.5CM)
樹種：天然松木
外框：面寬5cm 面厚 3.6cm
內枳：面寬1.5cm 面厚 1.8cm



DL-8256 雙面雕花(台灣製)

尺寸：長 X 寬 X 厚
廠規：242CM X 60CM X 3.6CM (±0.5CM)
樹種：天然松木
外框：面寬5cm 面厚 3.6cm
內枳：面寬1.5cm 面厚 1.8cm

就是想簡單橫的、直的
在加工雕刻的巧思

接受訂製
客製化



DL-8257 雙面雕花(台灣製)

尺寸：長 X 寬 X 厚
廠規：242CM X 60CM X 3.6CM (±0.5CM)
樹種：天然松木
外框：面寬5cm 面厚 3.6cm
內枳：面寬1.5cm 面厚 1.8cm

整體空間視覺
大而不空厚而不重

客製化
窗花

人造柚木

人造柚木

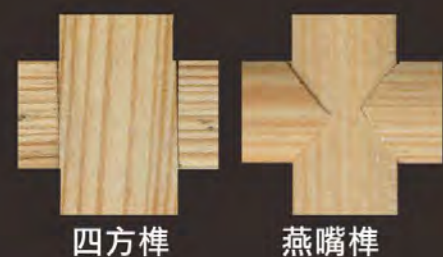

四方樺

燕嘴樺

■ 樹種

A 天然樹種

1.松木 2.美檜 3.越檜 4.柚木

B 人造樹種

1.人造柚木 2.人造胡桃

3.人造白橡

DL-8128

■ 雙面窗花

■ 尺寸：長X寬X厚

240X60X3.6CM±0.5CM

■ 內線條尺寸

15X18mm

■ 古藝技法—燕嘴樺

■ 接受任合尺寸訂做

(不含油漆)



DL-8129

■ 雙面窗花

■ 尺寸：長X寬X厚

204X55X3.6CM±0.5CM

■ 內線條尺寸

15X18mm

■ 古藝技法—燕嘴樺

時尚簡約—四方樺

■ 接受任合尺寸訂做 (不含油漆)



客製化
窗花

人造柚木

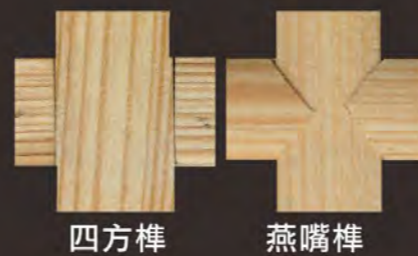

四方樺

燕嘴樺

■ 樹種

A 天然樹種

1.松木 2.美檜

3.越檜 4.柚木

B 人造樹種

1.人造柚木 2.人造胡桃

3.人造白橡

DL-8130

■ 雙面窗花

尺寸：長X寬X厚

226X60X3.6CM±0.5CM

■ 內線條尺寸

15X18mm

■ 古藝技法—燕嘴樺

時尚簡約—四方樺

■ 接受任合尺寸訂做

(不含油漆)

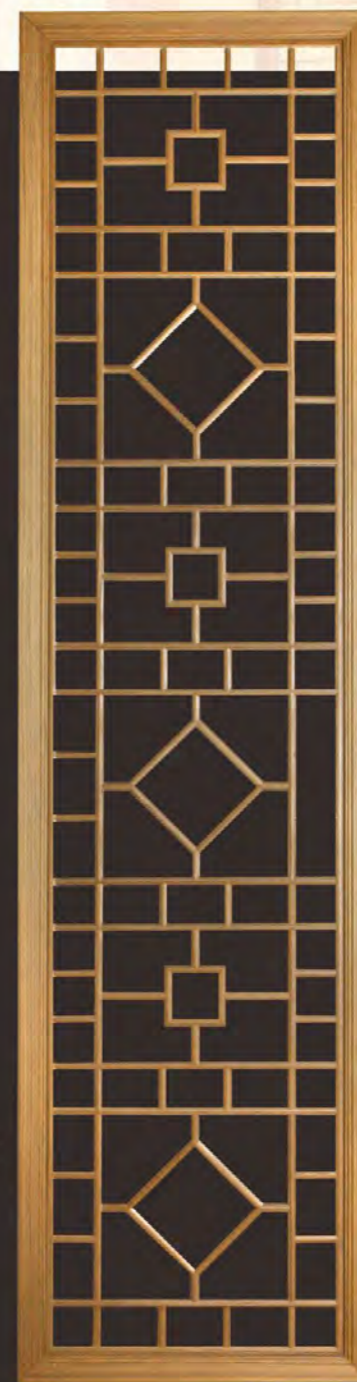

美檜原色

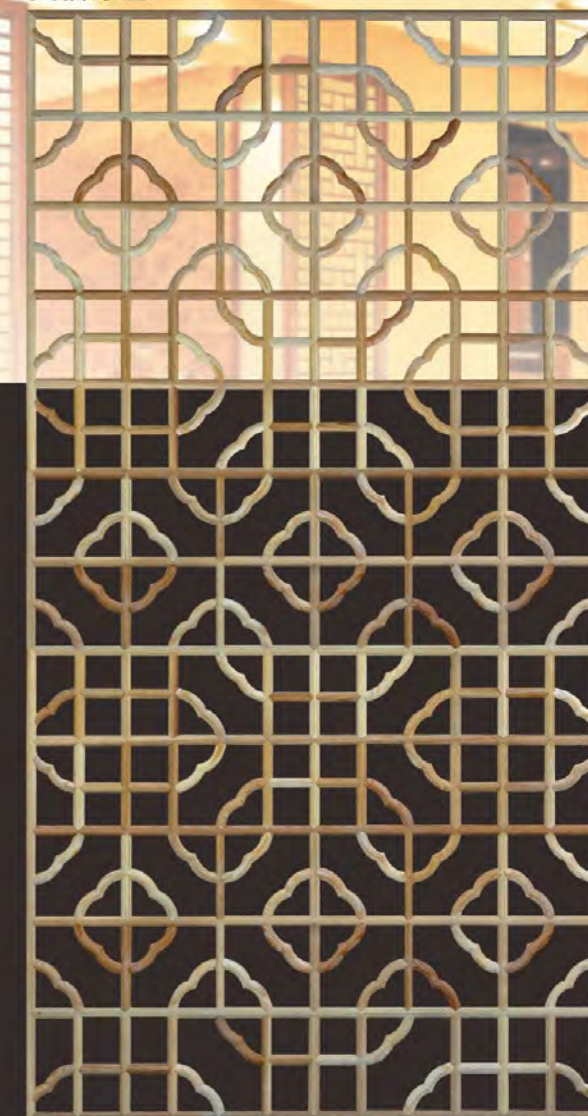

DL-8131

■ 雙面窗花

尺寸：長X寬X厚

145X75X1.8CM ±0.5CM

■ 內線條尺寸

15X18mm

■ 古藝技法—燕嘴樺

■ 接受任合尺寸訂做

(不含油漆)

人造柚木



DL-8132

- 雙面窗花
- 尺寸：長X寬X厚
172X48X1.8CM±0.5CM
- 內線條尺寸
15X18mm
- 古藝技法—燕嘴榫
- 接受任合尺寸訂做(不含油漆)

人造柚木



DL-8133

- 雙面窗花
- 尺寸：長X寬X厚
172X48X3.6CM±0.5CM
- 內線條尺寸
15X18mm
- 古藝技法—燕嘴榫
- 接受任合尺寸訂做(不含油漆)

客製化窗花



燕嘴榫

- 樹種
- A 天然樹種
1.松木 2.美檜 3.越檜 4.柚木
- B 人造樹種
1.人造柚木 2.人造胡桃
3.人造白橡

人造柚木



DL-8134

- 雙面窗花
- 尺寸：長X寬X厚
172X48X3.6CM±0.5CM
- 內線條尺寸
15X18mm
- 古藝技法—燕嘴榫
- 接受任合尺寸訂做(不含油漆)

人造柚木



DL-8135

- 雙面窗花
- 尺寸：長X寬X厚
201X56X3.6CM±0.5CM
- 內線條尺寸
15X18mm
- 古藝技法—燕嘴榫
時尚簡約—四方榫
- 接受任合尺寸訂做(不含油漆)

客製化窗花



四方榫 燕嘴榫

- 樹種
- A 天然樹種
1.松木 2.美檜
3.越檜 4.柚木
- B 人造樹種
1.人造柚木 2.人造胡桃
3.人造白橡

人造柚木

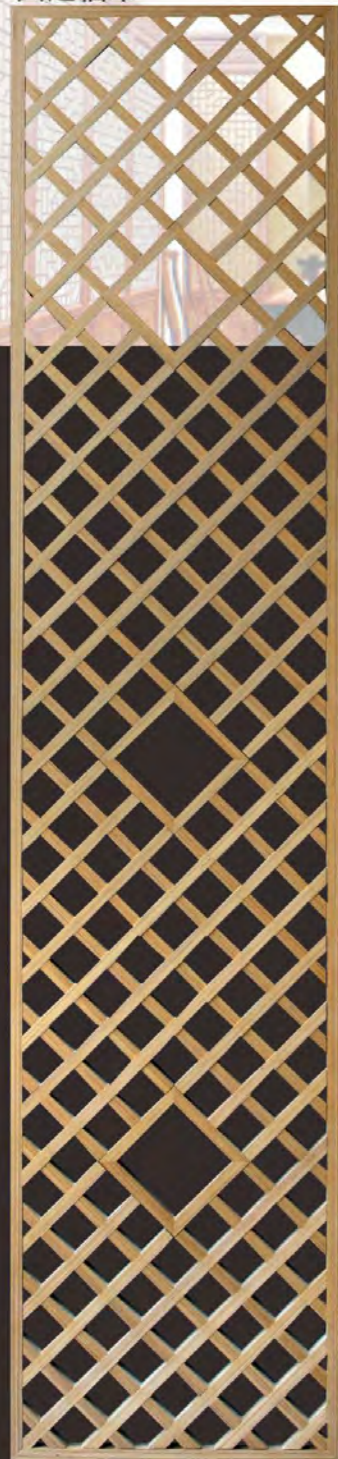

DL-8136

- 雙面窗花
- 尺寸：長X寬X厚
224X60X3.6CM±0.5CM
- 內線條尺寸 24X18mm

美檜原色

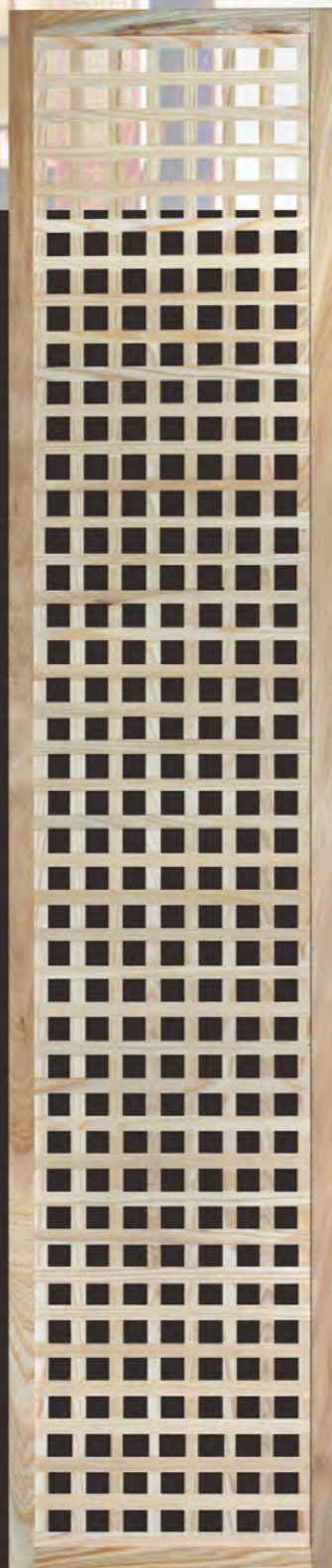

客製化窗花



四方樺

- 樹種
 - A 天然樹種
 - 1.松木 2.美檜
 - 3.越檜 4.柚木
 - B 人造樹種
 - 1.人造柚木 2.人造胡桃
 - 3.人造白橡

DL-8137

- 雙面窗花
- 尺寸：長X寬X厚
239X50X2.1CM±0.5CM
(孔距3.2CM±0.5CM)
- 內線條尺寸
24X12mm
- 時尚簡約—四方樺
- 接受任合尺寸訂做
(不含油漆)

美檜原色

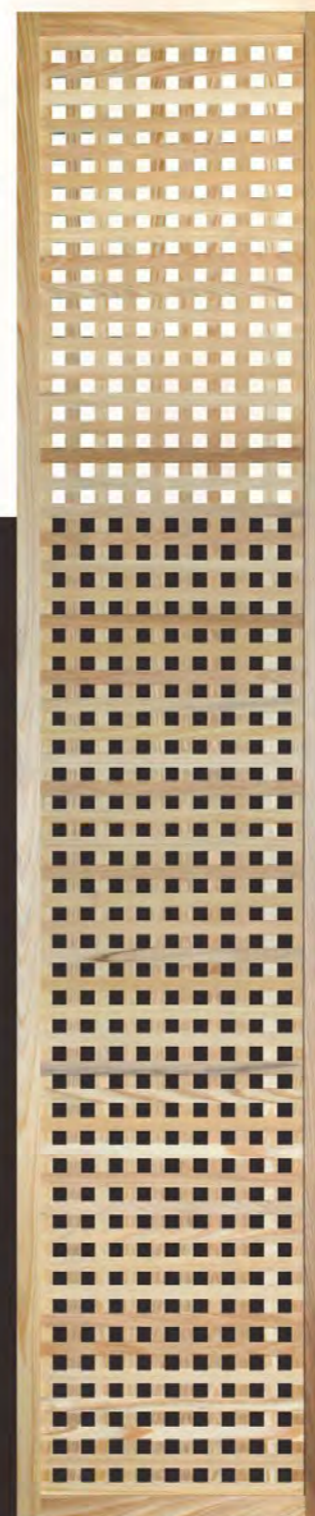

DL-8138

- 雙面窗花
- 尺寸：長X寬X厚
240X50X2.1CM±0.5CM
(孔距2.4CM±0.5CM)
- 內線條尺寸 24X12mm
- 時尚簡約—四方樺
- 接受任合尺寸訂做 (不含油漆)

美檜原色

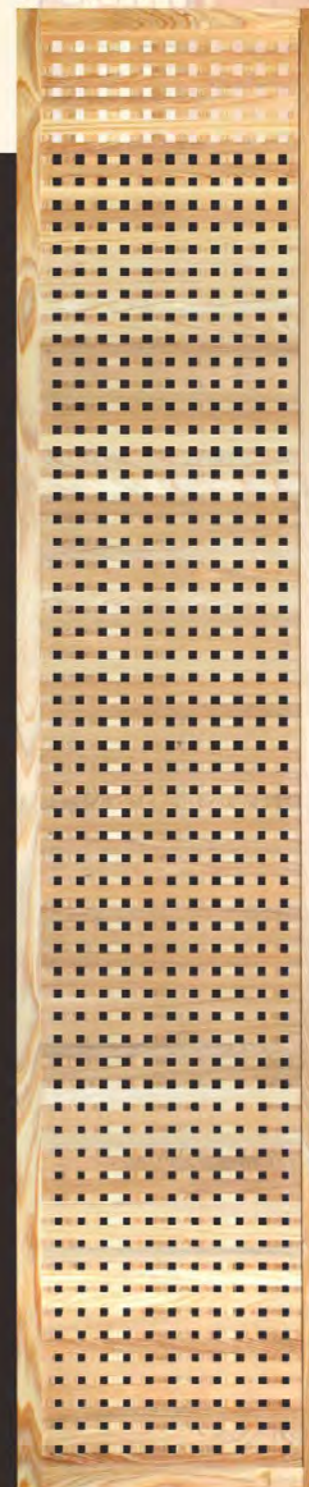

客製化窗花



四方樺

- 樹種
 - A 天然樹種
 - 1.松木 2.美檜
 - 3.越檜 4.柚木
 - B 人造樹種
 - 1.人造柚木 2.人造胡桃
 - 3.人造白橡

DL-8139

- 雙面窗花
- 尺寸：長X寬X厚
238.5X50X2.1CM±0.5CM
(孔距1.2CM±0.5CM)
- 內線條尺寸
24X12mm
- 時尚簡約—四方樺
- 接受任合尺寸訂做
(不含油漆)

接受訂製
天然柚木、越檜

立體面造型板

WF-027-3 ■ 金箔仿古
手工金銀箔造型板 ■ 樹種：松木
■ 尺寸：長X寬X厚 ■ 60X60X1.8CM ± 0.5CM

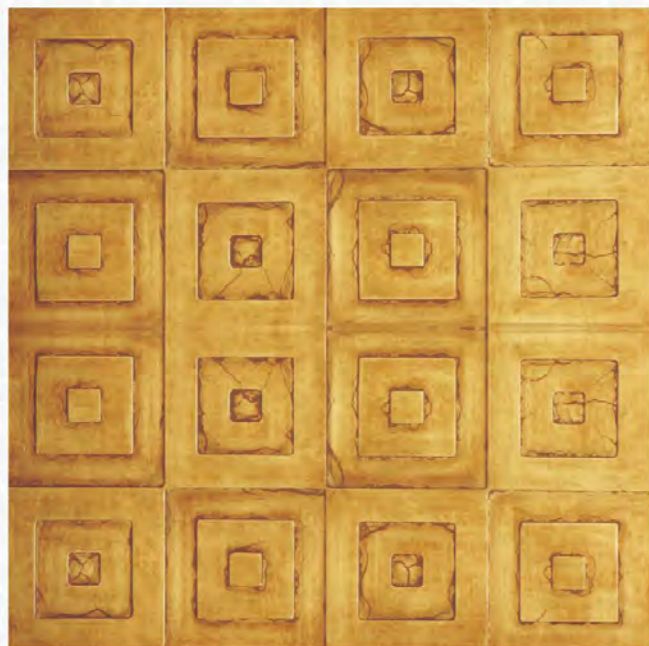

WF-027-5 ■ 銀箔仿古
手工金銀箔造型板 ■ 樹種：松木
■ 尺寸：長X寬X厚 ■ 60X60X1.8CM ± 0.5CM



WF-028-3 ■ 金箔仿古
手工金銀箔造型板 ■ 樹種：松木
■ 尺寸：長X寬X厚 ■ 60X60X1.8CM ± 0.5CM

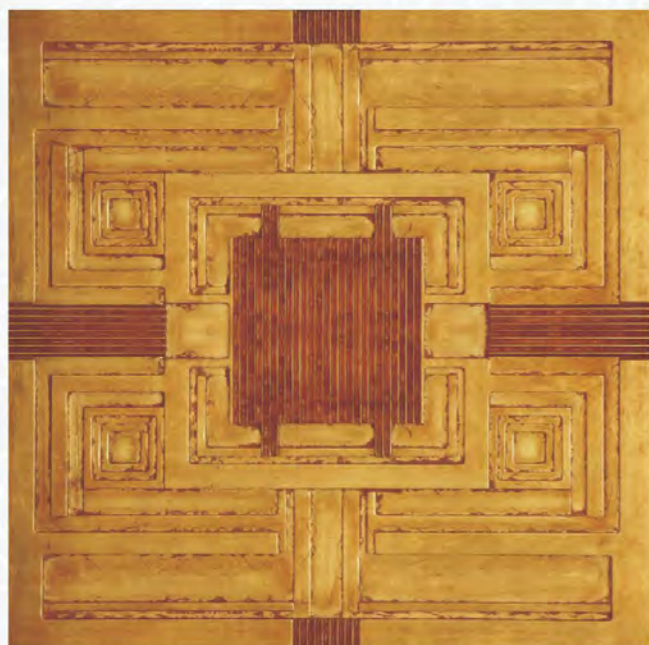

WF-028-5 ■ 銀箔仿古
手工金銀箔造型板 ■ 樹種：松木
■ 尺寸：長X寬X厚 ■ 60X60X1.8CM ± 0.5CM



簡約造型板

手工金銀箔造型板
■ 尺寸：長X寬X厚 ■ 60X60X2CM ± 0.5CM



WF-021-5 ■ 銀箔仿古-(天然樹種-松木)



WF-021-1 ■ 金箔原色-(天然樹種-松木)



WF-021-2 ■ 銀箔原色-(天然樹種-松木)



WF-021-3 ■ 金箔仿古-(天然樹種-松木)

天然實木造型板
■ 尺寸：長X寬X厚
■ 60X60X1.5CM ± 0.5CM
■ 複合式材料

6mm 天然實木
9mm 夾板

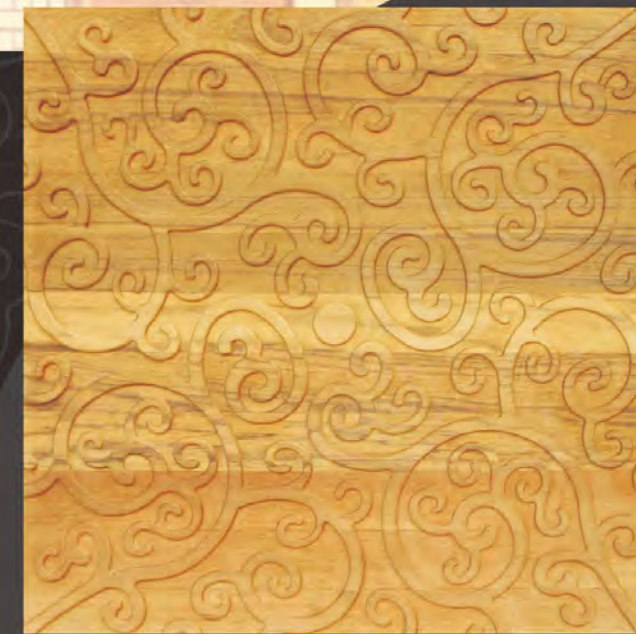

WF-7-021 ■ 天然樹種-柚木



WF-021 ■ 天然樹種-松木

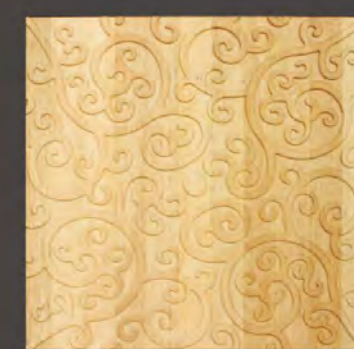

WF-5-021 ■ 天然樹種-白橡



WF-9-021 ■ 天然樹種-胡桃

簡約造型板

手工金銀箔造型板

- 尺寸：長X寬X厚
- 60X60X2CM ±0.5CM



WF-022-5 銀箔仿古-(天然樹種-松木)

天然實木造型板

- 尺寸：長X寬X厚
- 60X60X1.5CM ±0.5CM
- 複合式材料

6mm 天然實木
9mm 夾板



WF-7-022 天然樹種-柚木

簡約造型板

手工金銀箔造型板

- 尺寸：長X寬X厚
- 60X60X2CM ±0.5CM



WF-023-5 銀箔仿古-(天然樹種-松木)

天然實木造型板

- 尺寸：長X寬X厚
- 60X60X1.5CM ±0.5CM
- 複合式材料

6mm 天然實木
9mm 夾板



WF-7-023 天然樹種-柚木



WF-022-1 金箔原色-(天然樹種-松木)



WF-022 天然樹種-松木

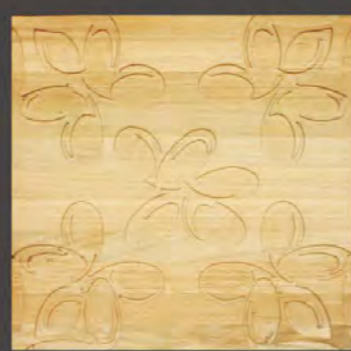

WF-5-022 天然樹種-白橡



WF-023-1 金箔原色-(天然樹種-松木)



WF-023 天然樹種-松木



WF-5-023 天然樹種-白橡



WF-022-2 銀箔原色-(天然樹種-松木)



WF-022-3 金箔仿古-(天然樹種-松木)



WF-9-022 天然樹種-胡桃



WF-023-2 銀箔原色-(天然樹種-松木)

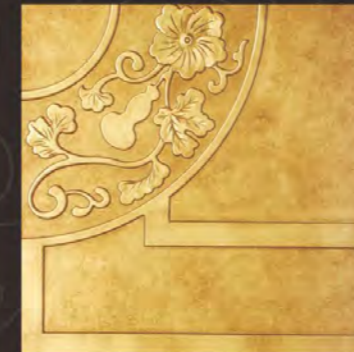

WF-023-3 金箔仿古-(天然樹種-松木)



WF-9-023 天然樹種-胡桃

簡約造型板

手工金銀箔造型板

- 尺寸：長X寬X厚
- 60X60X2CM ±0.5CM

天然實木造型板

- 尺寸：長X寬X厚
- 60X60X1.5CM ±0.5CM
- 複合式材料

6mm 天然實木
9mm 夾板

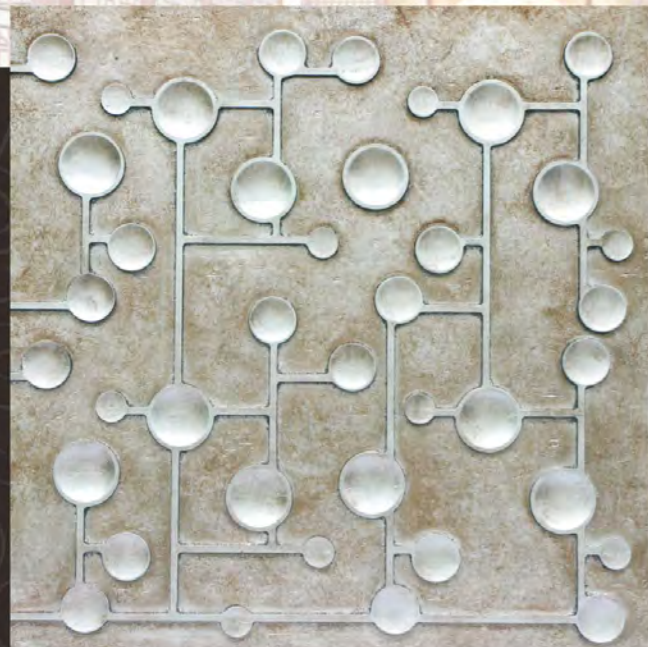

WF-024-5 銀箔仿古-(天然樹種-松木)



WF-7-024 天然樹種-柚木



WF-024-1 金箔原色-(天然樹種-松木)



WF-024 天然樹種-松木

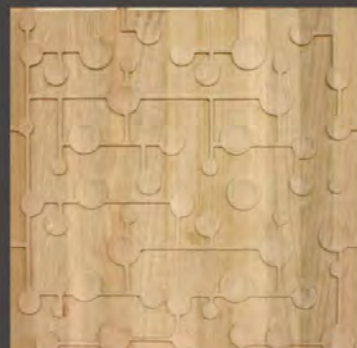

WF-5-024 天然樹種-白橡



WF-024-2 銀箔原色-(天然樹種-松木)



WF-024-3 金箔仿古-(天然樹種-松木)



WF-9-024 天然樹種-胡桃

簡約造型板

手工金銀箔造型板

- 尺寸：長X寬X厚
- 60X60X2CM ±0.5CM

天然實木造型板

- 尺寸：長X寬X厚
- 60X60X1.5CM ±0.5CM
- 複合式材料

6mm 天然實木
9mm 夾板



WF-025-5 銀箔仿古-(天然樹種-松木)

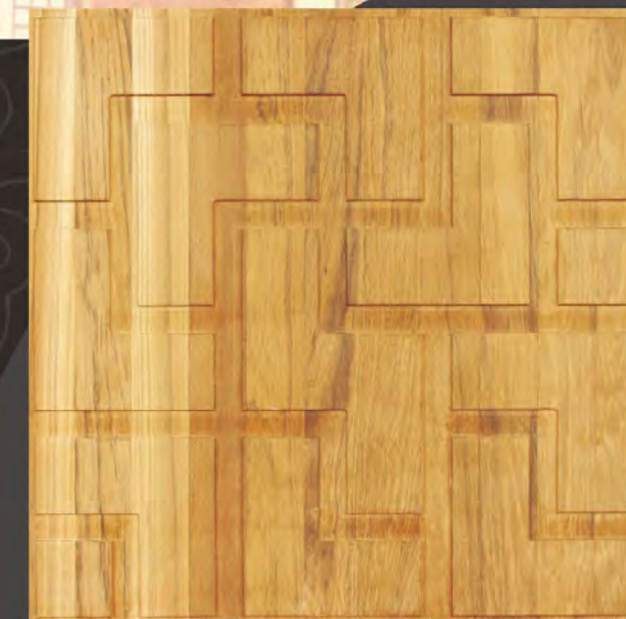

WF-7-025 天然樹種-柚木



WF-025-1 金箔原色-(天然樹種-松木)

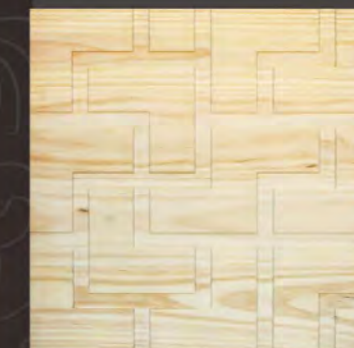

WF-025 天然樹種-松木



WF-5-025 天然樹種-白橡



WF-025-2 銀箔原色-(天然樹種-松木)



WF-025-3 金箔仿古-(天然樹種-松木)



WF-9-025 天然樹種-胡桃

簡約造型板

手工金銀箔造型板

- 尺寸：長X寬X厚
- 60X60X2CM ±0.5CM



WF-026-5 銀箔仿古-(天然樹種-松木)

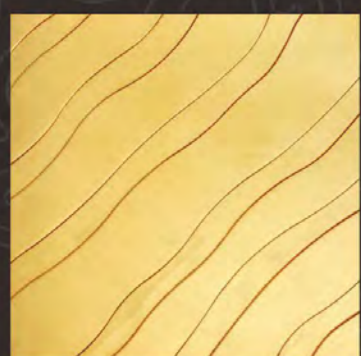

WF-026-1 金箔原色-(天然樹種-松木)

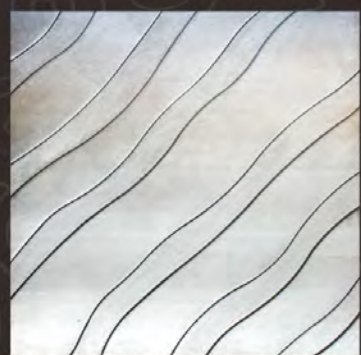

WF-026-2 銀箔原色-(天然樹種-松木)

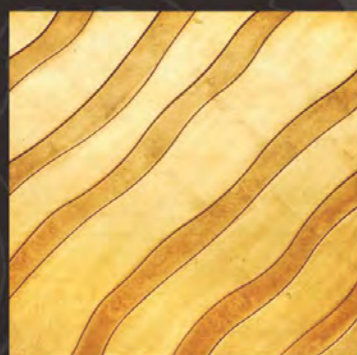

WF-026-3 金箔仿古-(天然樹種-松木)



WF-026 天然樹種-松木

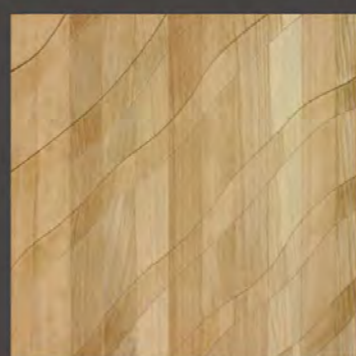

WF-5-026 天然樹種-白橡



WF-9-026 天然樹種-胡桃

天然實木造型板

- 尺寸：長X寬X厚
- 60X60X1.5CM ±0.5CM
- 複合式材料

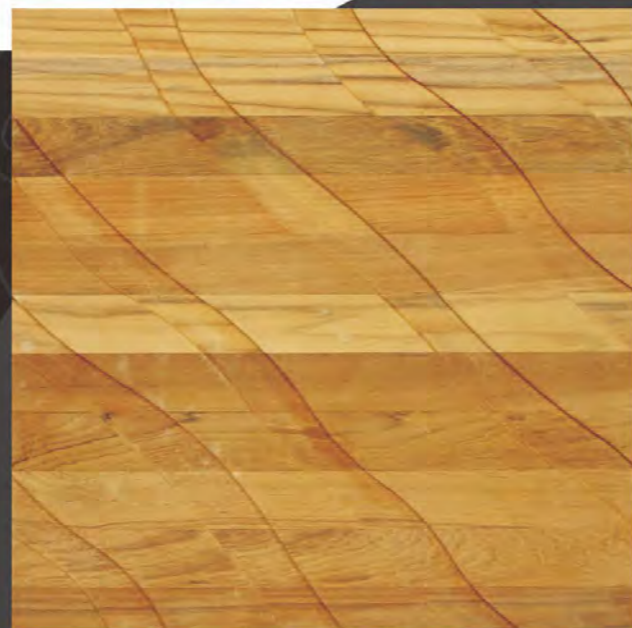

WF-7-026 天然樹種-柚木



大凹圓剖面圖

WF-031-1

- 金箔原色-(天然樹種-松木)
- 尺寸：長X寬X厚
- 240X12X2CM ±0.5CM



WF-031-2

- 銀箔原色-(天然樹種-松木)
- 尺寸：長X寬X厚
- 240X12X2CM ±0.5CM



WF-031-3

- 金箔仿古-(天然樹種-松木)
- 尺寸：長X寬X厚
- 240X12X2CM ±0.5CM



WF-031-5

- 銀箔仿古-(天然樹種-松木)
- 尺寸：長X寬X厚
- 240X12X2CM ±0.5CM



WF-C-1501

- 金箔原色-(天然樹種-松木)
- 尺寸：長X寬X厚
- 15X15X3.6CM ±0.5CM



WF-C-1502

- 銀箔原色-(天然樹種-松木)
- 尺寸：長X寬X厚
- 15X15X3.6CM ±0.5CM



WF-C-1503

- 金箔仿古-(天然樹種-松木)
- 尺寸：長X寬X厚
- 15X15X3.6CM ±0.5CM



WF-C-1505

- 金箔仿古-(天然樹種-松木)
- 尺寸：長X寬X厚
- 15X15X3.6CM ±0.5CM

鑽片剖面圖

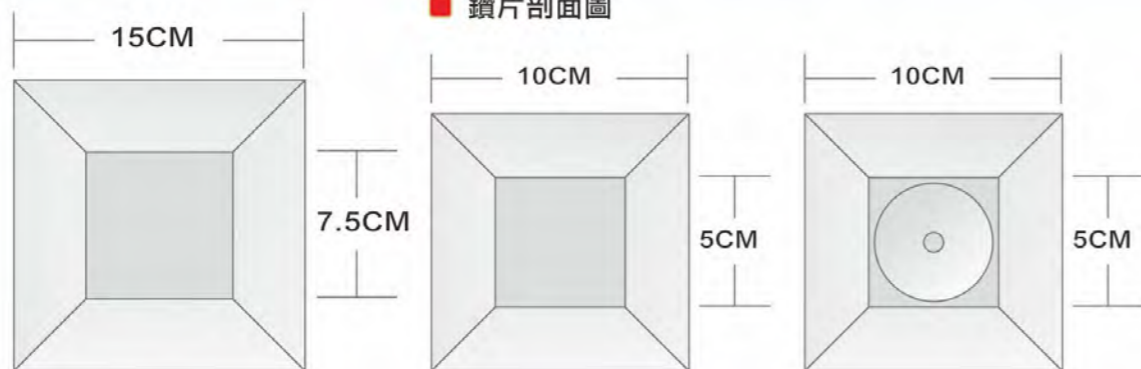

WF-C-1601

- 金箔原色-(天然樹種-松木)
- 尺寸：長X寬X厚
- 15X15X2.7CM ±0.5CM



WF-C-1602

- 銀箔原色-(天然樹種-松木)
- 尺寸：長X寬X厚
- 15X15X2.7CM ±0.5CM

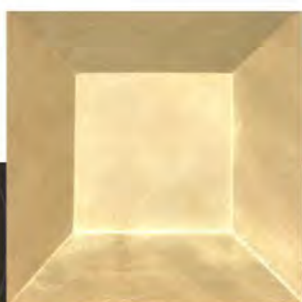

WF-C-1603

- 金箔仿古-(天然樹種-松木)
- 尺寸：長X寬X厚
- 15X15X2.7CM ±0.5CM



WF-C-1605

- 金箔仿古-(天然樹種-松木)
- 尺寸：長X寬X厚
- 15X15X2.7CM ±0.5CM



WF-C-1701

- 金箔原色-(天然樹種-松木)
- 尺寸：長X寬X厚
- 10X10X2.7CM ±0.5CM

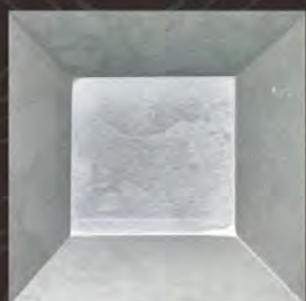

WF-C-1702

- 銀箔原色-(天然樹種-松木)
- 尺寸：長X寬X厚
- 10X10X2.7CM ±0.5CM



WF-C-1703

- 金箔仿古-(天然樹種-松木)
- 尺寸：長X寬X厚
- 10X10X2.7CM ±0.5CM



WF-C-1705

- 金箔仿古-(天然樹種-松木)
- 尺寸：長X寬X厚
- 10X10X2.7CM ±0.5CM

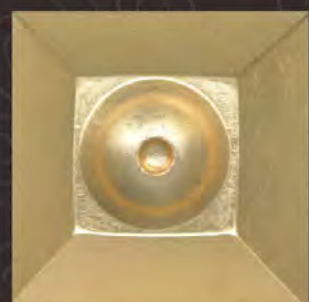

WF-C-1801

- 金箔原色-(天然樹種-松木)
- 尺寸：長X寬X厚
- 10X10X2.7CM ±0.5CM



WF-C-1802

- 銀箔原色-(天然樹種-松木)
- 尺寸：長X寬X厚
- 10X10X2.7CM ±0.5CM



WF-C-1803

- 金箔仿古-(天然樹種-松木)
- 尺寸：長X寬X厚
- 10X10X2.7CM ±0.5CM



WF-C-1805

- 金箔仿古-(天然樹種-松木)
- 尺寸：長X寬X厚
- 10X10X2.7CM ±0.5CM

紅酒架 接受任合尺寸訂製



WF-W-3220

- 水洗白紅酒架
- 尺寸：長X寬X厚
- 108X49.5X22CM ±0.5CM



WF-W-3820

- 水洗白紅酒架
- 尺寸：長X寬X厚
- 65X92.5X22CM ±0.5CM



WF-W-2416

- 水洗白紅酒架
- 尺寸：長X寬X厚
- 63.5X64.5X22CM ±0.5CM



WF-F-2416

- 火紋木紅酒架
- 尺寸：長X寬X厚
- 64.5X63.5X22CM ±0.5CM



WF-F-3820

- 火紋木紅酒架
- 尺寸：長X寬X厚
- 65X92.5X22CM ±0.5CM

WF-F-3220

- 火紋木紅酒架
- 尺寸：長X寬X厚
- 108X49.5X22CM ±0.5CM

造型紅酒架

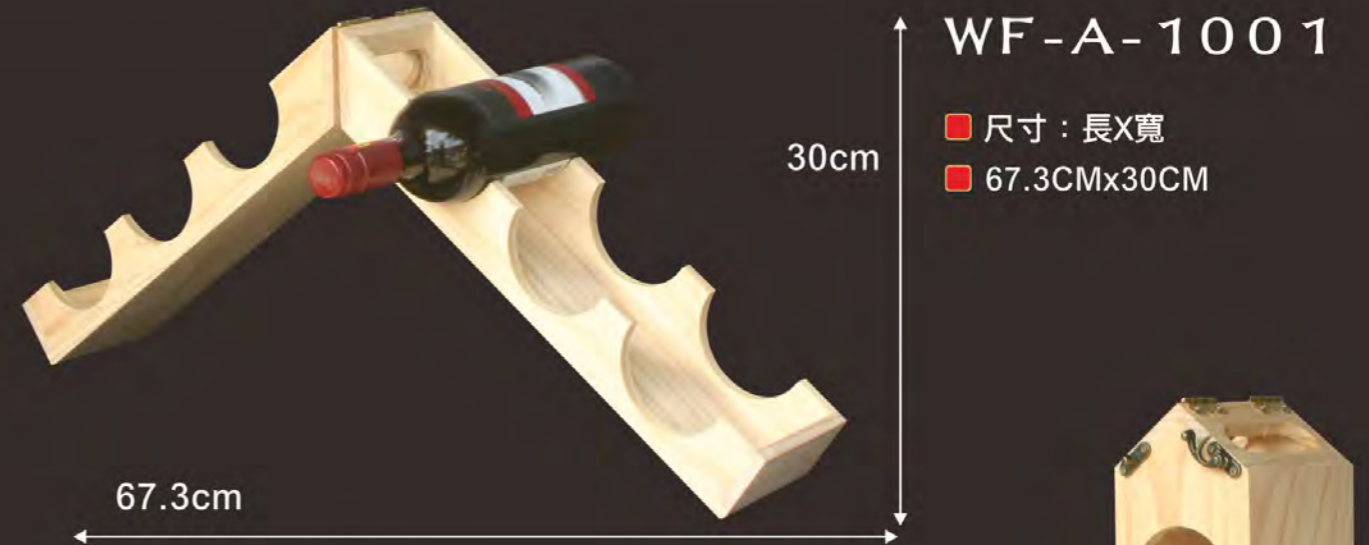

WF-A-1001

- 尺寸：長X寬
- 67.3CMx30CM

67.3cm

30cm



- 尺寸：長X寬X深
- 42x11x10cm

- 尺寸：長X寬X深

- 84x11x5.5cm



84cm

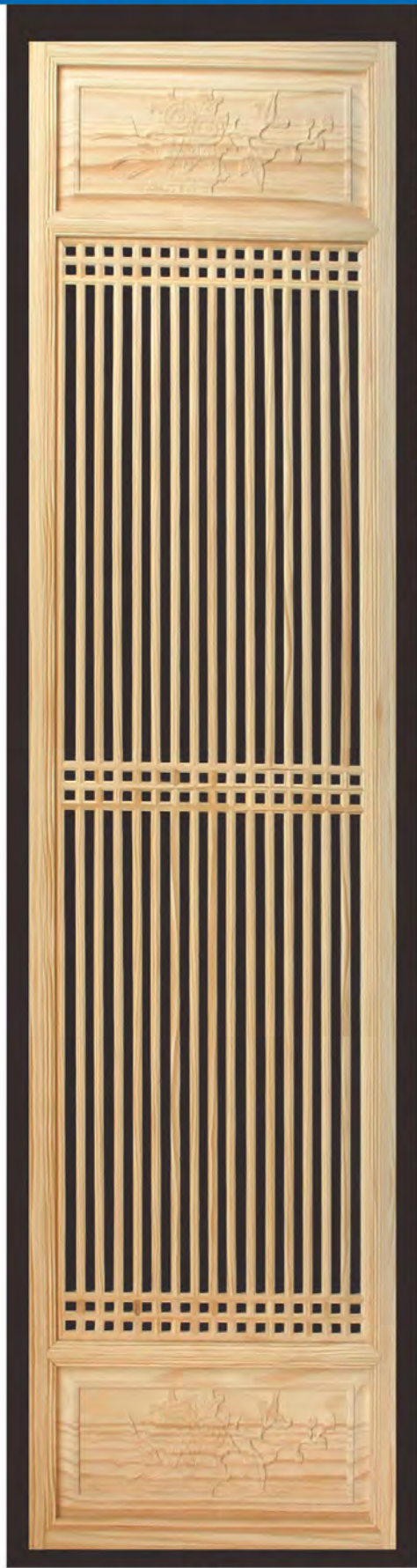

DL-8258 雙面雕花(台灣製)

尺寸：長 X 寬 X 厚
 廠規：242CM X 60CM X 3.6CM (±0.5CM)
 樹種：天然松木
 外框：面寬5cm 面厚 3.6cm
 內枳：面寬1.5cm 面厚 1.8cm

中式窗花風格
 清雅含蓄、端莊豐華的東方精神境界

隔柵空間中另一種民族特色標誌、符號
 簡約的造型中添加了東方元素

接受訂製
 客製化

DL-8259 雙面雕花(台灣製)

尺寸：長 X 寬 X 厚
 廠規：242CM X 60CM X 3.6CM (±0.5CM)
 樹種：天然松木
 外框：面寬5cm 面厚 3.6cm
 內枳：面寬1.5cm 面厚 1.8cm



屏風

風格的氛圍中
 採用簡潔硬朗的直線條
 上、下隱約的透實感成就光線的美



接受訂製
 客製化

DL-8260 屏風組~雙面雕花(台灣製)

尺寸：長 X 寬 X 厚
 廠規：242.4CM X 60.6CM X 3.6CM (±0.5CM)
 整組尺寸：242.4CM X 242.4CM X 3.6CM (±0.5CM)
 樹種：天然松木
 外框：面寬5cm 面厚 3.6cm
 內枳：面寬1.5cm 面厚 1.8cm

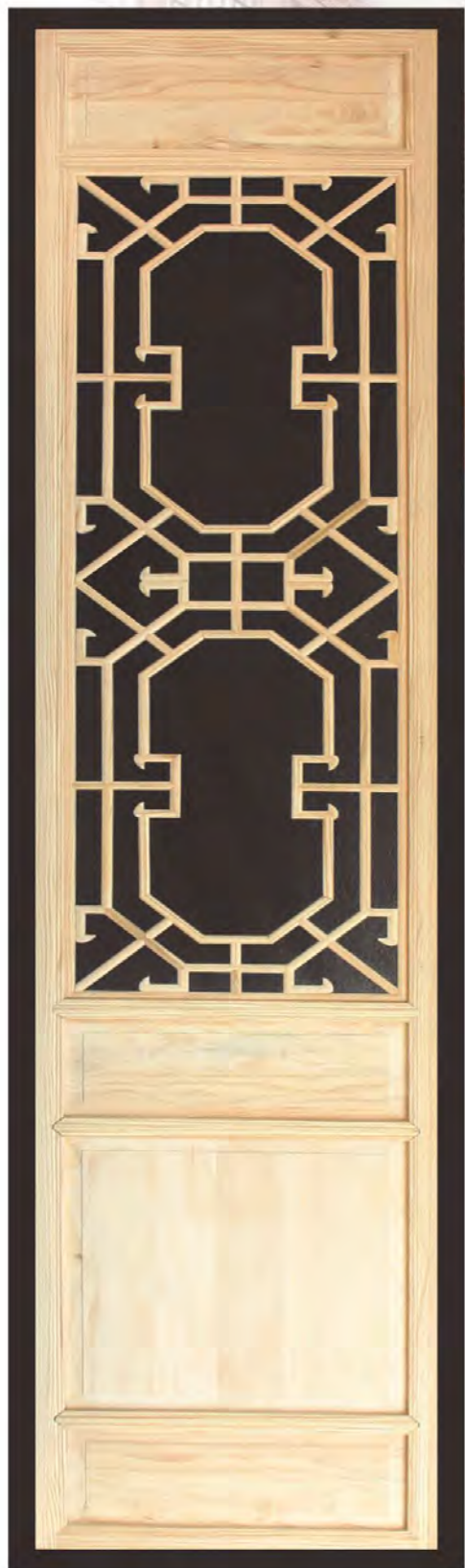

DL-8261 雙面雕花(台灣製)

尺寸：長 X 寬 X 厚
 廠規：303CM X 60.6CM X 3.6CM (±0.5CM)
 樹種：天然松木
 外框：面寬5cm 面厚 3.6cm
 內枳：面寬1.5cm 面厚 1.8cm

接受訂製
客製化

簡潔硬朗的直線條
 新式風格迎合中式追求內斂
 角度與樺的結合展現出門的大氣和素雅

DL-8262 雙面雕花(台灣製)

尺寸：長 X 寬 X 厚
 廠規：150CM X 45CM X 3.6CM (±0.5CM)
 樹種：天然松木
 外框：面寬5cm 面厚 3.6cm
 內枳：面寬1.5cm 面厚 1.8cm

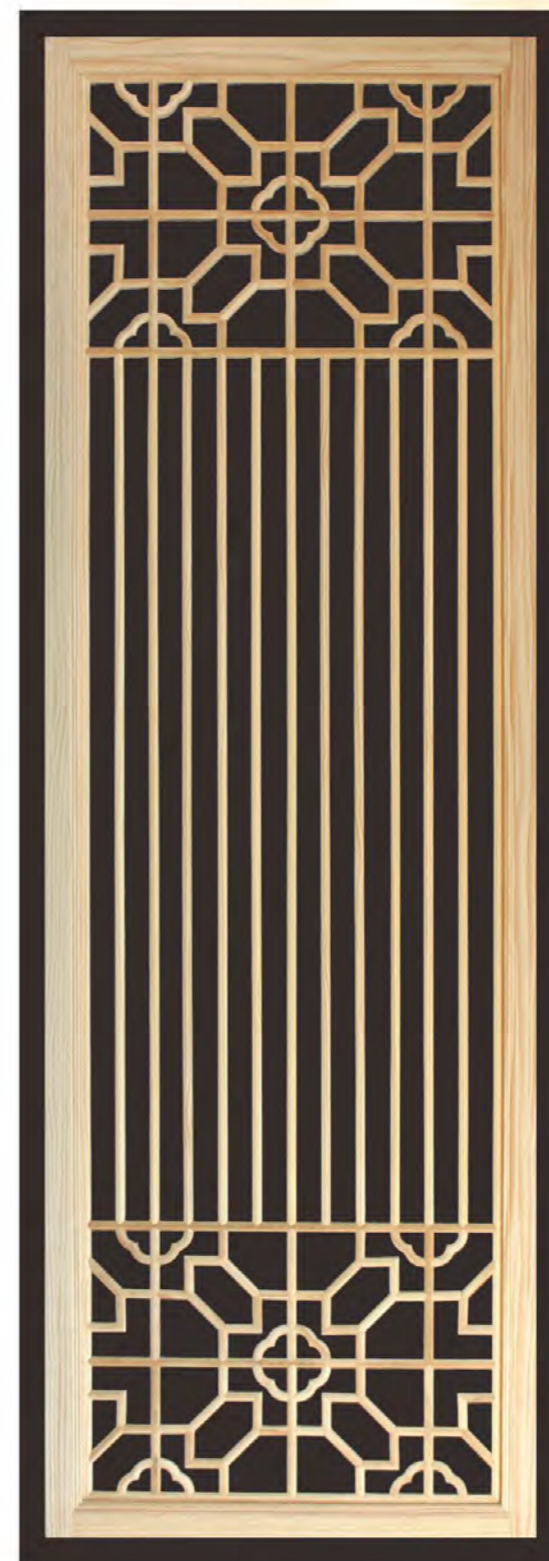

DL-8263 雙面雕花(台灣製)

尺寸：長 X 寬 X 厚
 廠規：242CM X 80CM X 3.6CM (±0.5CM)
 樹種：天然松木
 外框：面寬6cm 面厚 3.6cm
 內枳：面寬1.5cm 面厚 1.8cm

接受訂製
客製化

傳統的佈局格式 但不遵循守舊
 運用現代工藝自成一格及特色

DL-8264 雙面雕花(台灣製)

尺寸：長 X 寬 X 厚
 廠規：242CM X 60CM X 3.6CM (±0.5CM)
 樹種：天然松木
 外框：面寬6cm 面厚 3.6cm
 內枳：面寬1.5cm 面厚 1.8cm



卍字符意為吉祥萬德之所集也

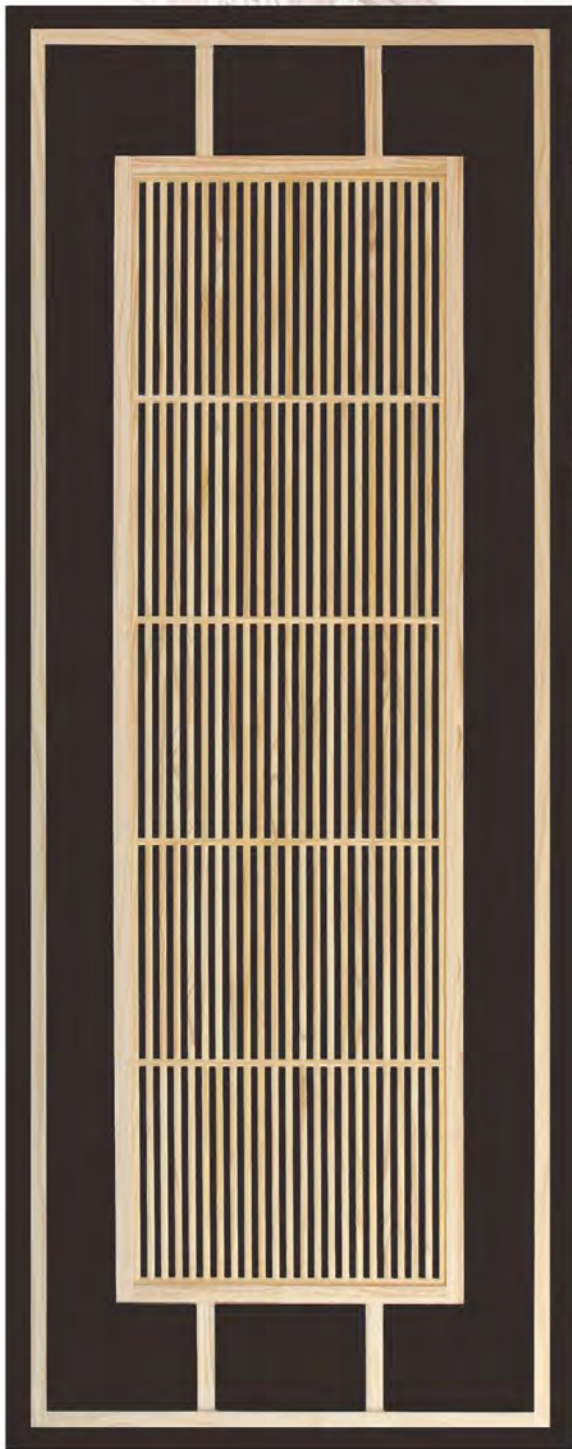

DL-8265 雙面雕花(台灣製)
 尺寸：長 X 寬 X 厚
 廠規：242CM X 90CM X 3.6CM (±0.5CM)
 樹種：天然松木
 外框：面寬3cm 面厚 3.6cm
 內枳：面寬1.2cm 面厚 1.8cm

禪境，只想光線斜斜的透進屋內
 享受著稀微的光亮

接受訂製
 客製化

窗花格屏透過光線
 柔和搭配繽紛家具讓空間氛圍有生氣

DL-8266 雙面雕花(台灣製)
 尺寸：長 X 寬 X 厚
 廠規：220CM X 66CM X 3.6CM (±0.5CM)
 樹種：天然松木
 外框：面寬3cm 面厚 3.6cm
 內枳：面寬1.5cm 面厚 1.8cm



DL-8267 雙面雕花(台灣製)
 尺寸：長 X 寬 X 厚
 廠規：242CM X 56.5CM X 3.6CM (±0.5CM)
 樹種：天然松木
 外框：面寬5cm 面厚 3.6cm
 內枳：面寬1.5cm 面厚 1.8cm



簡單明瞭 原味風格呈現東方空間禪味

接受訂製
 客製化

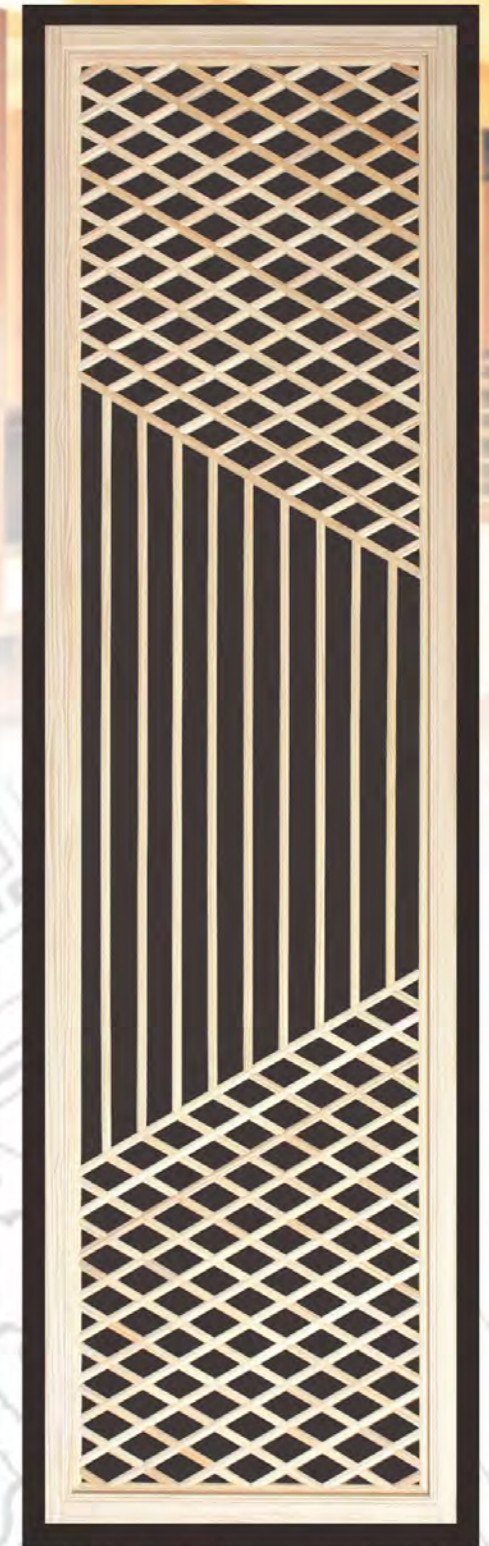

DL-8268 雙面雕花(台灣製)
 尺寸：長 X 寬 X 厚
 廠規：242CM X 68CM X 3.6CM (±0.5CM)
 樹種：天然松木
 外框：面寬5cm 面厚 3.6cm
 內枳：面寬1.5cm 面厚 1.8cm

東方線條與稜角斜線結合之柔美

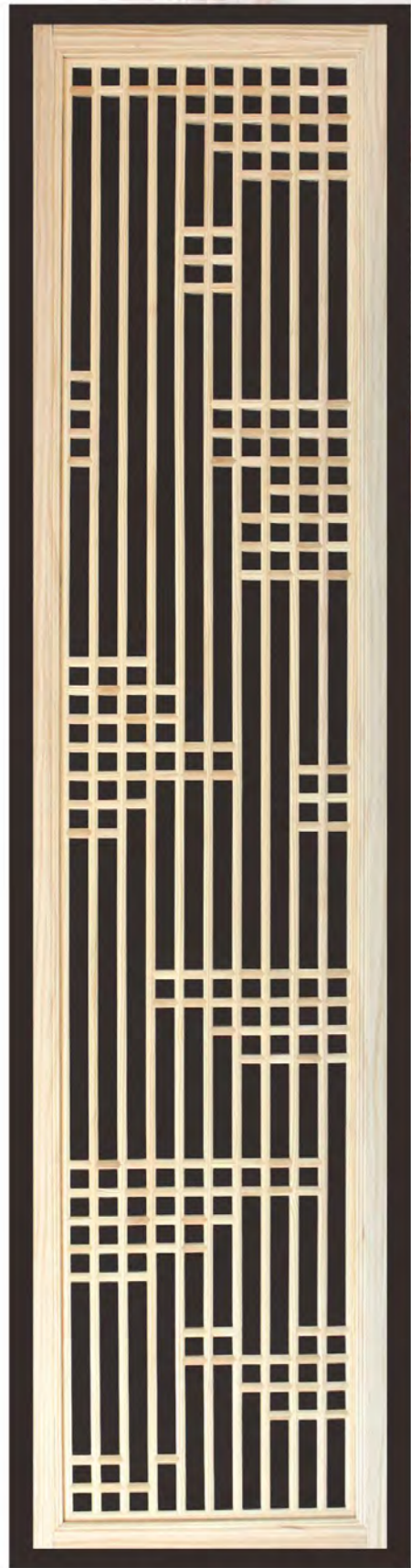

DL-8269 雙面雕花(台灣製)

尺寸：長 X 寬 X 厚
 廠規：242CM X 56.5CM X 3.6CM (±0.5CM)
 樹種：天然松木
 外框：面寬5cm 面厚 3.6cm
 內枳：面寬1.5cm 面厚 1.8cm

DL-8270 雙面雕花(台灣製)

尺寸：長 X 寬 X 厚
 廠規：240CM X 60CM X 3.6CM (±0.5CM)
 樹種：天然松木
 外框：面寬5cm 面厚 3.6cm
 內枳：面寬1.5cm 面厚 1.8cm

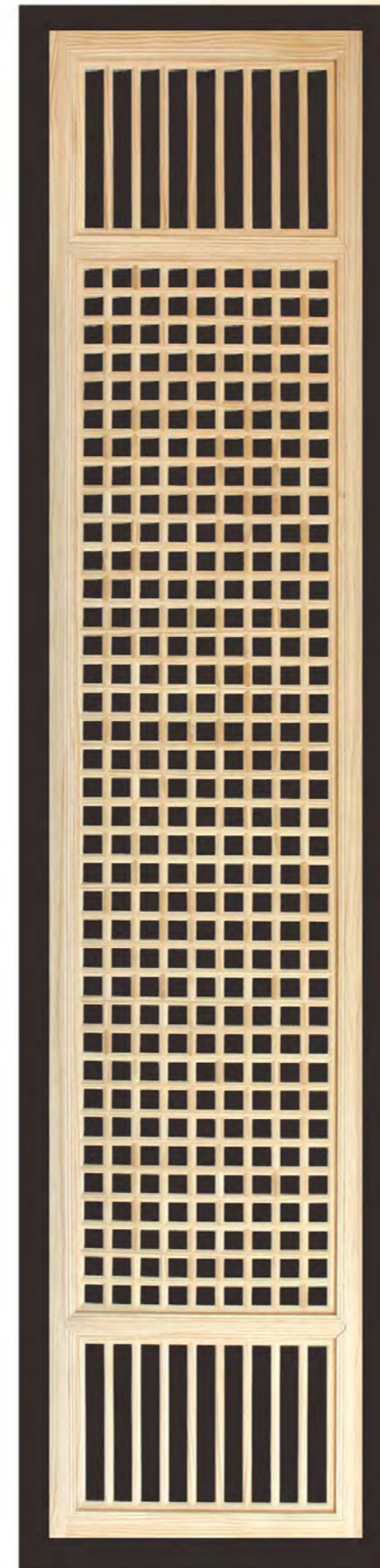

DL-8271 雙面雕花(台灣製)

尺寸：長 X 寬 X 厚
 廠規：260CM X 50CM X 3.6CM (±0.5CM)
 樹種：天然松木
 外框：面寬5cm 面厚 3.6cm
 內枳：面寬1.5cm 面厚 1.8cm



WF-A-7041

■ 樹種-松木榴節
 ■ 尺寸：長X寬X厚
 ■ 1尺x8尺12mm

接受訂製
 客製化

窗花以不同變化去作巧妙
 搭配展現結合微妙感

方塊幾何線條 細膩柔美舒適感
 排列出不同風貌

中國風禪意表現 方格中看生活
 柔軟元素淡化沈重 拘謹舒適中有著生活禪的味道

接受訂製
 客製化



WF-A-7036

■ 榆木-年輪丁掛 ■ 尺寸：長X寬X厚 ■ 1尺x4尺 ■ 厚0.5cm+1.0cm+1.5cm

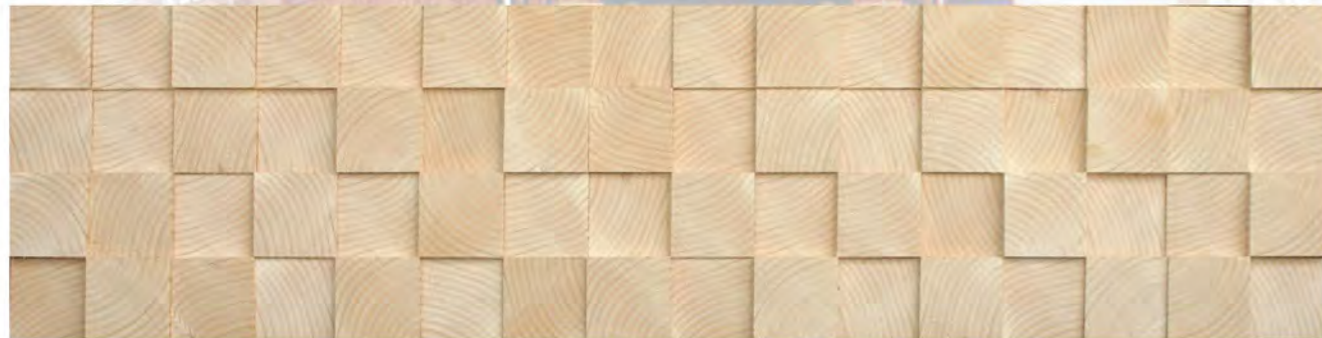

WF-A-7037

■ 雲杉-年輪丁掛 ■ 尺寸：長X寬X厚 ■ 1尺x4尺 ■ 厚0.5cm+1.0cm+1.5cm



WF-A-7038

■ 柚木-年輪丁掛 ■ 尺寸：長X寬X厚 ■ 1尺x4尺 ■ 厚0.5cm+1.0cm+1.5cm



WF-A-7040

■ 亞洲胡桃-年輪丁掛 ■ 尺寸：長X寬X厚 ■ 1尺x4尺 ■ 厚0.5cm+1.0cm+1.5cm

手工金銀箔造型板

■ 尺寸：長X寬X厚 ■ 60X60X1.8CM ± 0.5CM

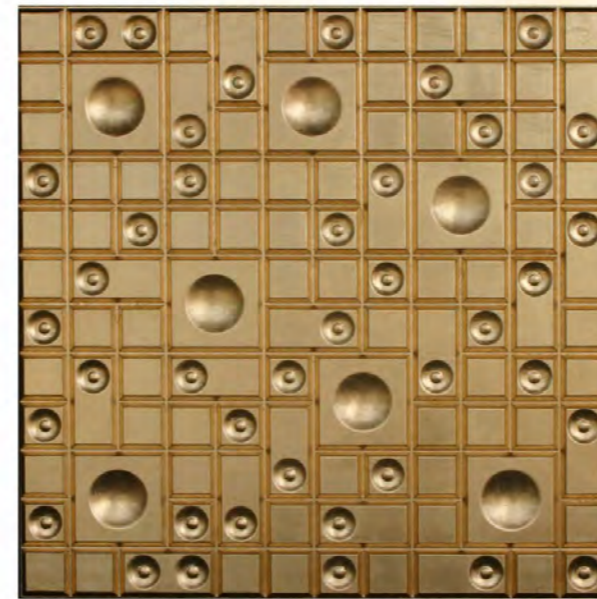

WF-029-1

■ 金箔原色-(天然樹種-松木)



WF-030-5

■ 銀箔仿古(天然樹種-松木)

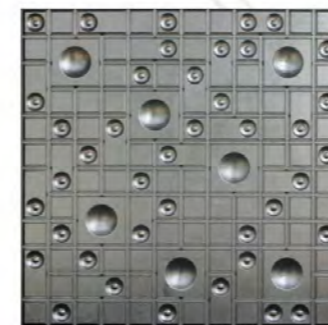

WF-029-2

■ 銀箔原色
(天然樹種-松木)

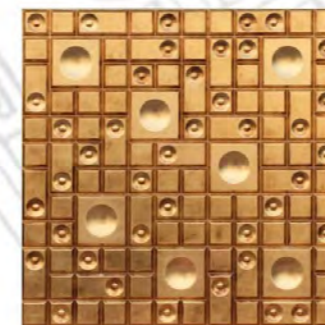

WF-029-3

■ 金箔仿古
(天然樹種-松木)

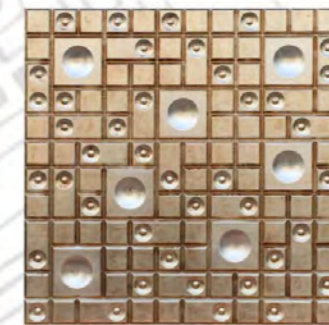

WF-029-5

■ 銀箔仿古
(天然樹種-松木)



WF-029

■ 天然樹種-松木



WF-030-1

■ 金箔原色
(天然樹種-松木)



WF-030-2

■ 銀箔原色
(天然樹種-松木)



WF-030-3

■ 金箔仿古
(天然樹種-松木)



WF-030

■ 天然樹種-松木

■長度以10尺為主(3000mm)



WF-2201
素面雕刻花線板



WF-2201-1
手工貼製仿古金箔修飾土



WF-2201-2
手工貼製仿古銀箔修飾土

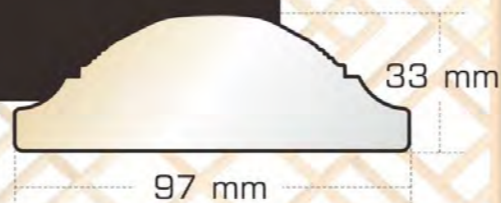

素面柱腳
WF-103
30X15X5CM
高 X 寬 X 厚

素面柱腳
WF-105
30X15X5CM
高 X 寬 X 厚

■長度以10尺為主(3000mm)



WF-2202 素面雕刻花線板



WF-2202-1 手工貼製仿古金箔修飾土



WF-2202-2 手工貼製仿古銀箔修飾土

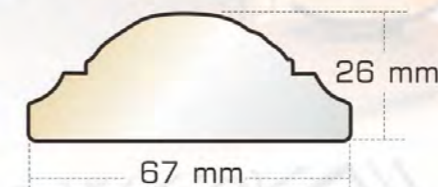

WF-2203 素面雕刻花線板

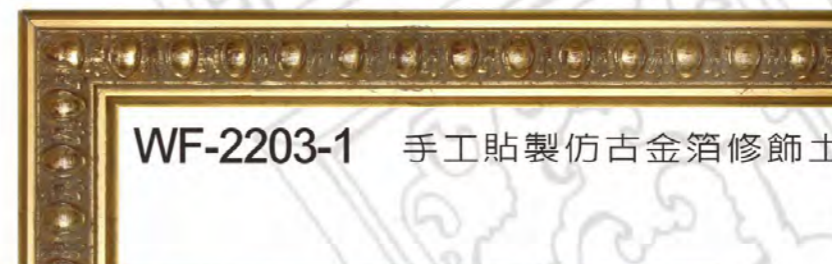

WF-2203-1 手工貼製仿古金箔修飾土



WF-2203-2 手工貼製仿古銀箔修飾土

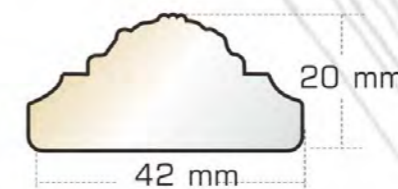

金箔柱腳
WF-103-1
30X15X5CM
高 X 寬 X 厚



銀箔柱腳
WF-103-2
30X15X5CM
高 X 寬 X 厚



金箔柱腳
WF-105-1
30X15X5CM
高 X 寬 X 厚



銀箔柱腳
WF-105-2
30X15X5CM
高 X 寬 X 厚

■長度以10尺為主(3000mm)

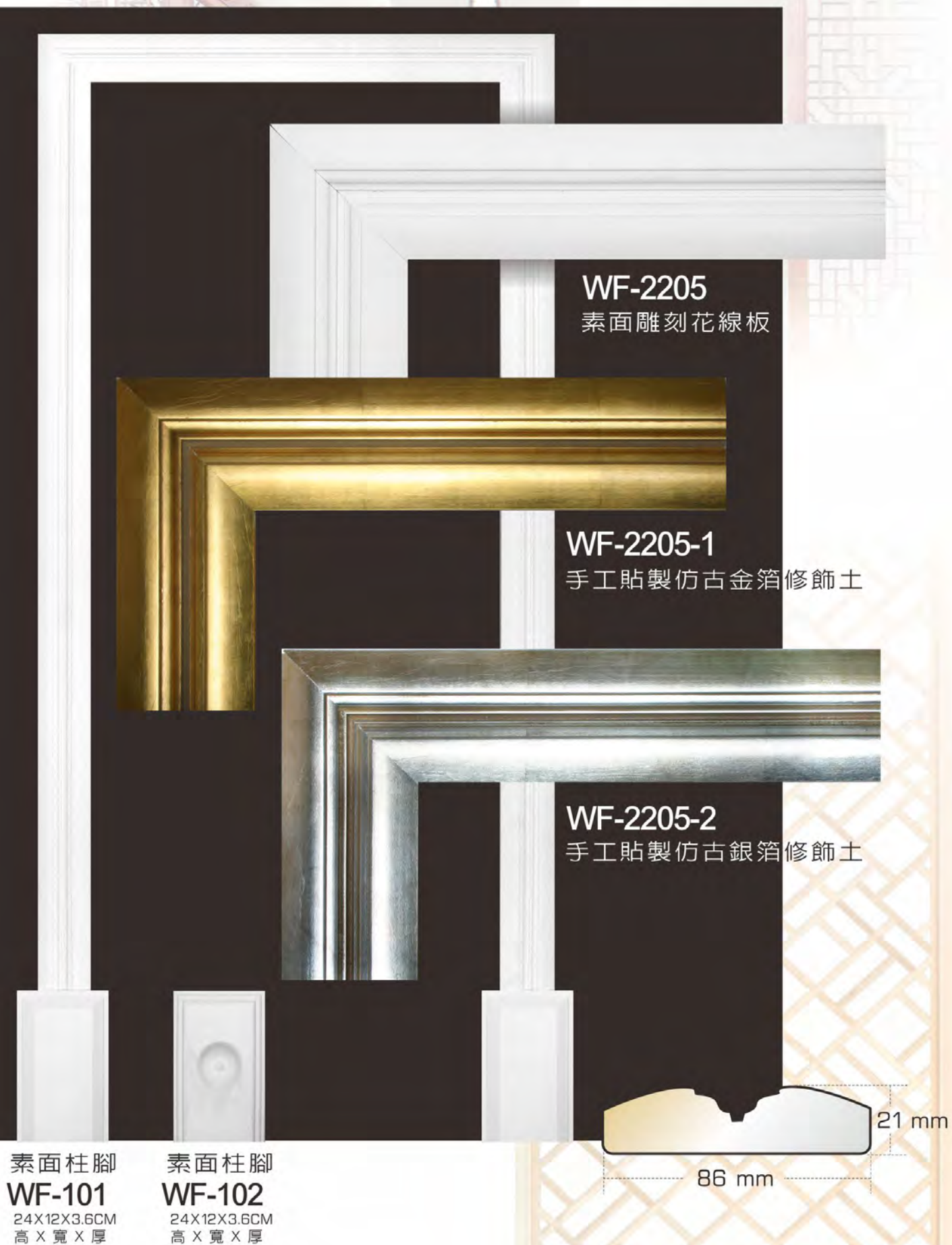

素面柱腳
WF-101
24X12X3.6CM
高 X 寬 X 厚

素面柱腳
WF-102
24X12X3.6CM
高 X 寬 X 厚

■長度以10尺為主(3000mm)

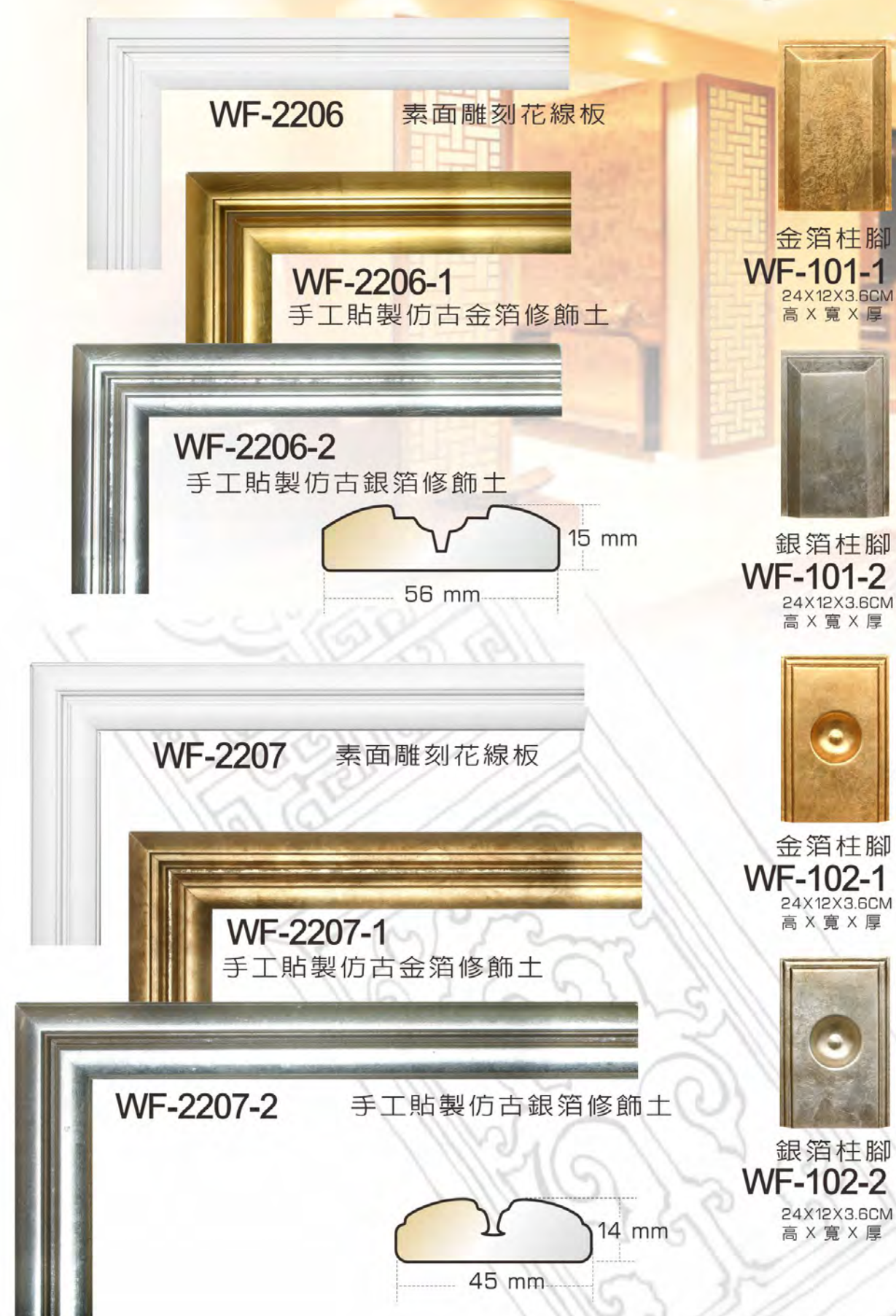

WF-2206 素面雕刻花線板

WF-2206-1
手工貼製仿古金箔修飾土

WF-2206-2
手工貼製仿古銀箔修飾土



WF-2207 素面雕刻花線板

WF-2207-1
手工貼製仿古金箔修飾土

WF-2207-2 手工貼製仿古銀箔修飾土

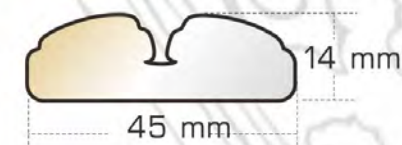

金箔柱腳
WF-101-1
24X12X3.6CM
高 X 寬 X 厚

銀箔柱腳
WF-101-2
24X12X3.6CM
高 X 寬 X 厚

金箔柱腳
WF-102-1
24X12X3.6CM
高 X 寬 X 厚

銀箔柱腳
WF-102-2
24X12X3.6CM
高 X 寬 X 厚

■長度以10尺為主(3000mm)



金箔柱腳
WF-101-1
24X12X3.6CM
高 X 寬 X 厚



銀箔柱腳
WF-101-2
24X12X3.6CM
高 X 寬 X 厚



金箔柱腳
WF-102-1
24X12X3.6CM
高 X 寬 X 厚



銀箔柱腳
WF-102-2
24X12X3.6CM
高 X 寬 X 厚

素面柱腳 WF-101 24X12X3.6CM 高 X 寬 X 厚
素面柱腳 WF-102 24X12X3.6CM 高 X 寬 X 厚



■長度以10尺為主(3000mm)

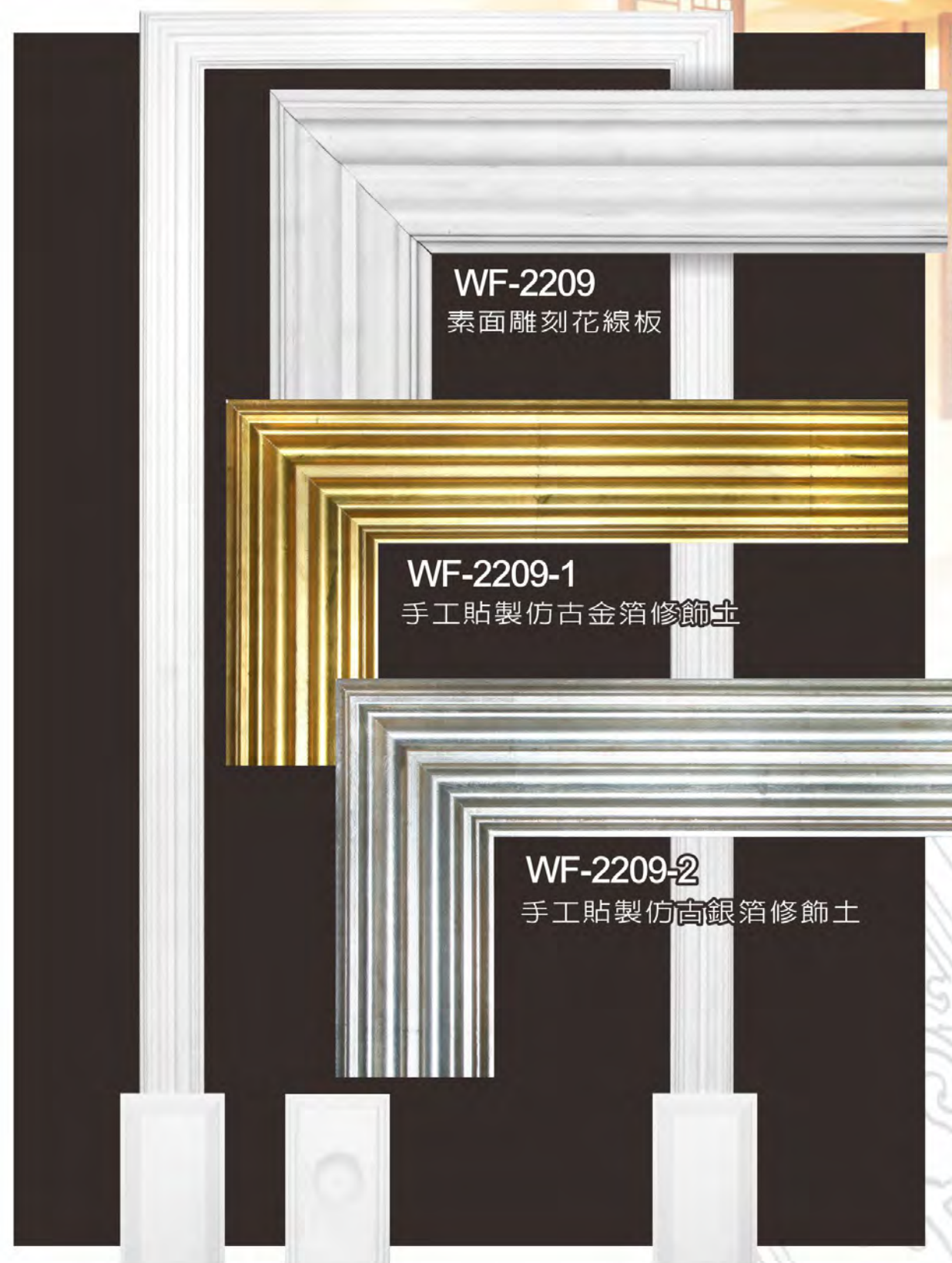

金箔柱腳
WF-101-1
24X12X3.6CM
高 X 寬 X 厚



銀箔柱腳
WF-101-2
24X12X3.6CM
高 X 寬 X 厚



金箔柱腳
WF-102-1
24X12X3.6CM
高 X 寬 X 厚



銀箔柱腳
WF-102-2
24X12X3.6CM
高 X 寬 X 厚

素面柱腳 WF-101 24X12X3.6CM 高 X 寬 X 厚
素面柱腳 WF-102 24X12X3.6CM 高 X 寬 X 厚

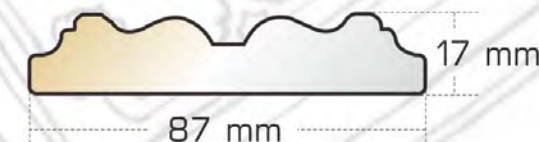

■長度以10尺為主(3000mm)



WF-2210
素面雕刻花線板

WF-2210-1
手工貼製仿古金箔修飾土

WF-2210-2
手工貼製仿古銀箔修飾土

素面柱腳
WF-103
30X15X5CM
高 X 寬 X 厚

素面柱腳
WF-105
30X15X5CM
高 X 寬 X 厚



金箔柱腳
WF-103-1
30X15X5CM
高 X 寬 X 厚

銀箔柱腳
WF-103-2
30X15X5CM
高 X 寬 X 厚

金箔柱腳
WF-105-1
30X15X5CM
高 X 寬 X 厚

銀箔柱腳
WF-105-2
30X15X5CM
高 X 寬 X 厚

■長度以10尺為主(3000mm)



WF-2211
素面雕刻花線板

WF-2211-1
手工貼製仿古金箔修飾土

WF-2211-2
手工貼製仿古銀箔修飾土

素面柱腳
WF-103
30X15X5CM
高 X 寬 X 厚

素面柱腳
WF-105
30X15X5CM
高 X 寬 X 厚

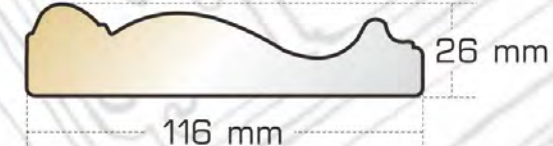

金箔柱腳
WF-103-1
30X15X5CM
高 X 寬 X 厚

銀箔柱腳
WF-103-2
30X15X5CM
高 X 寬 X 厚

金箔柱腳
WF-105-1
30X15X5CM
高 X 寬 X 厚

銀箔柱腳
WF-105-2
30X15X5CM
高 X 寬 X 厚

■長度以10尺為主(3000mm)

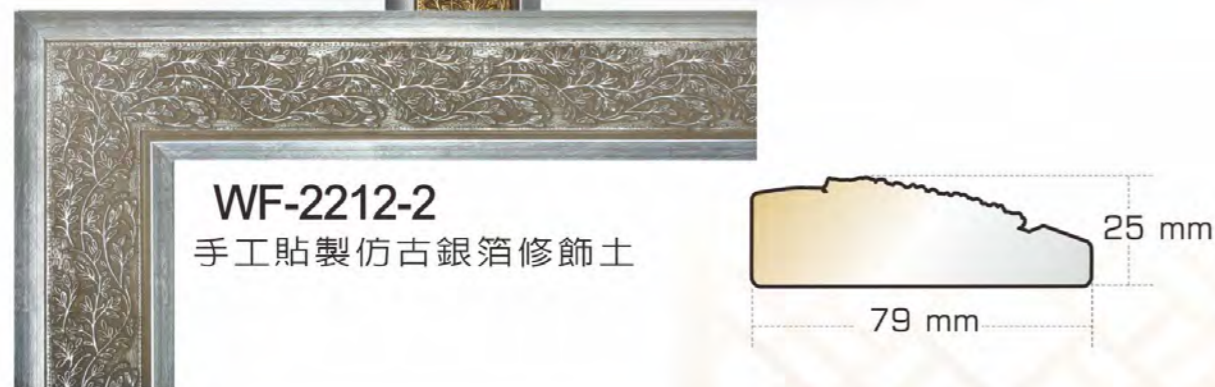

■長度以10尺為主(3000mm)



■長度以10尺為主(3000mm)

WF-2217 素面雕刻花線板

WF-2217-1 手工貼製仿古金箔修飾土

WF-2217-2 手工貼製仿古銀箔修飾土



WF-2173 素面雕刻花線板



WF-2173-1 手工貼製仿古金箔

WF-2173-2 手工貼製仿古銀箔

■長度以10尺為主(3000mm)

引領尊貴

WF-2150-1 手工貼製仿古金箔修飾土

WF-2150-2 手工貼製仿古銀箔修飾土

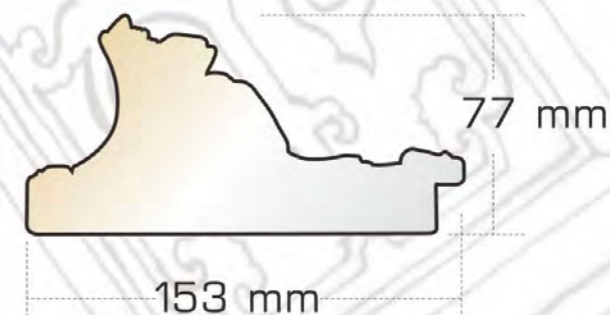

■長度以10尺為主(3000mm)



WF-2151-1 手工貼製仿古金箔修飾土



WF-2151-2 手工貼製仿古銀箔修飾土



完美呈現

■長度以10尺為主(3000mm)



WF-2152-1 手工貼製仿古金箔



WF-2152-2 手工貼製仿古銀箔

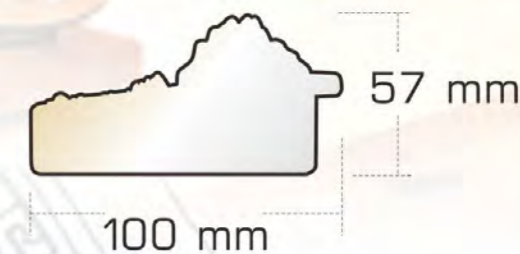

WF-2153-1 手工貼製仿古金箔

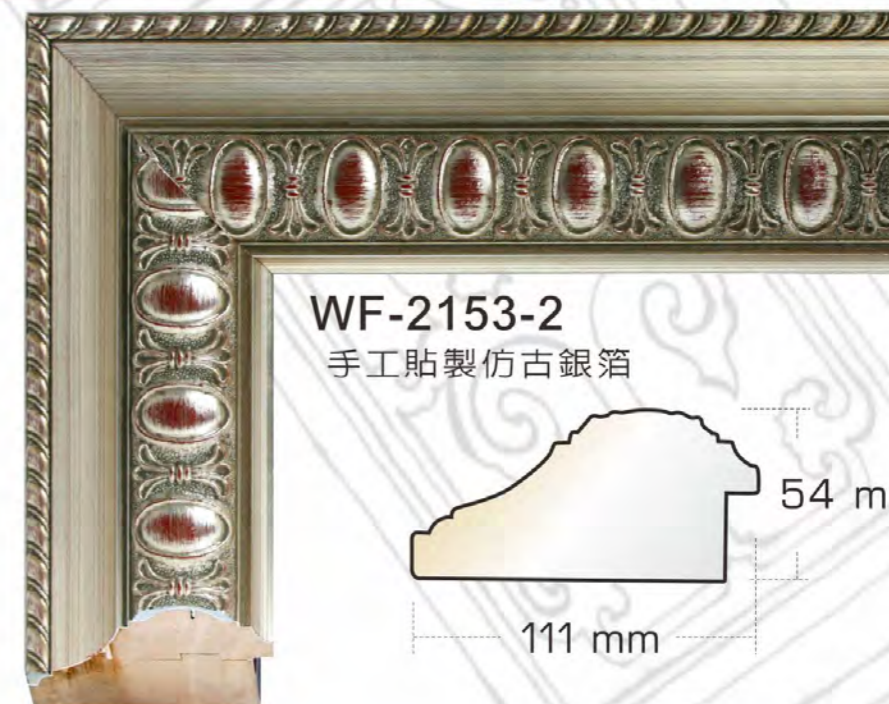

WF-2153-2 手工貼製仿古銀箔

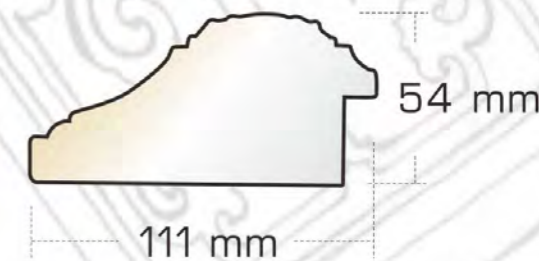

■長度以10尺為主(3000mm)



WF-2155-1 手工貼製金箔揉紙技法



WF-2155-2 手工貼製銀箔揉紙技法



WF-2156-1 手工貼製仿古金箔

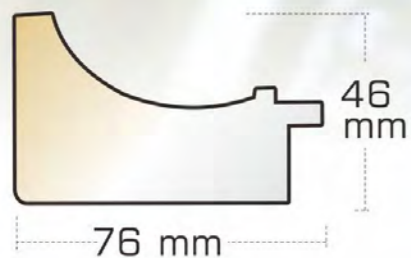

WF-2156-2 手工貼製仿古銀箔

■長度以10尺為主(3000mm)



WF-2157-1 手工貼製香檳金箔



WF-2157-2 手工貼製香檳銀箔



WF-2158-1 手工貼製金箔揉紙技法

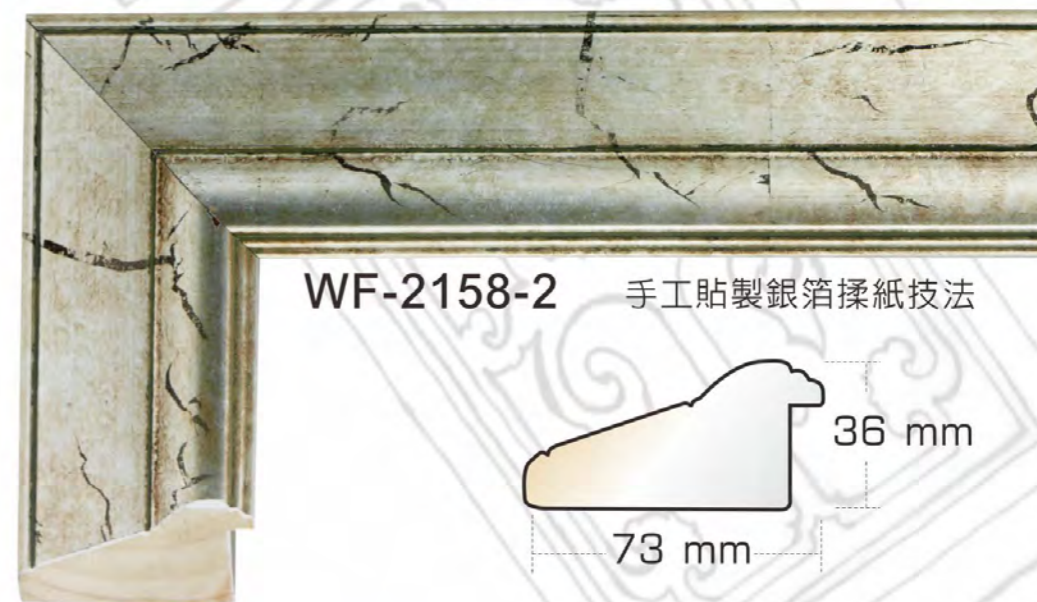

WF-2158-2 手工貼製銀箔揉紙技法

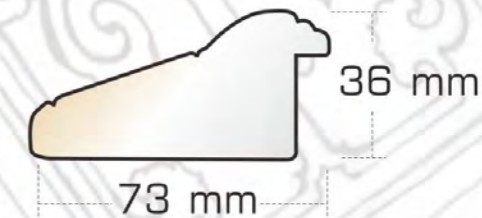

■長度以10尺為主(3000mm)



WF-2159-1 手工貼製金箔揉紙技法



WF-2159-2 手工貼製銀箔揉紙技法



WF-2160-1 手工貼製雪花金箔技法

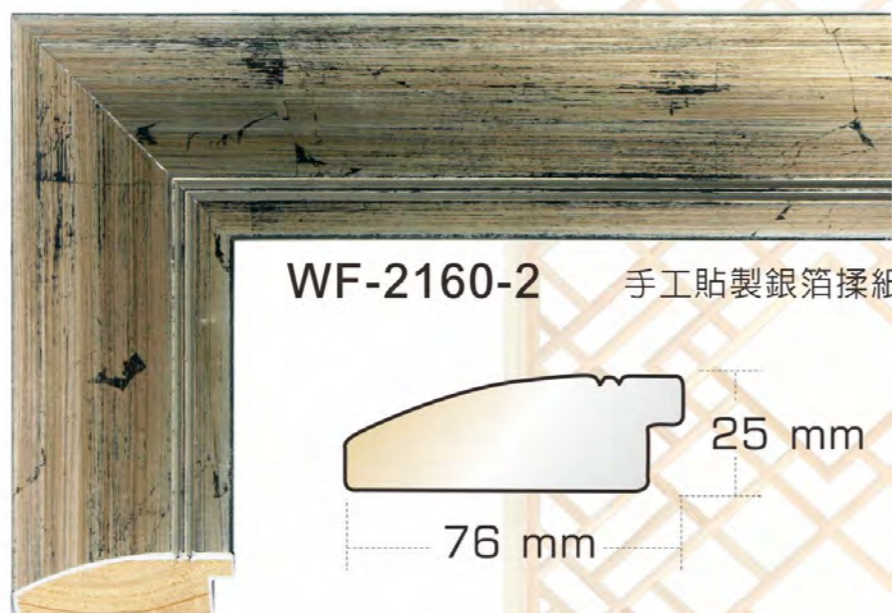

WF-2160-2 手工貼製銀箔揉紙技法

■長度以10尺為主(3000mm)



WF-2161-1 手工貼製雪花金箔技法



WF-2161-2 手工貼製雪花銀箔技法



WF-2162-1 彩裂漆金箔原色



WF-2162-2 彩裂漆銀箔原色



WF-2163-1 手工貼製仿古金箔

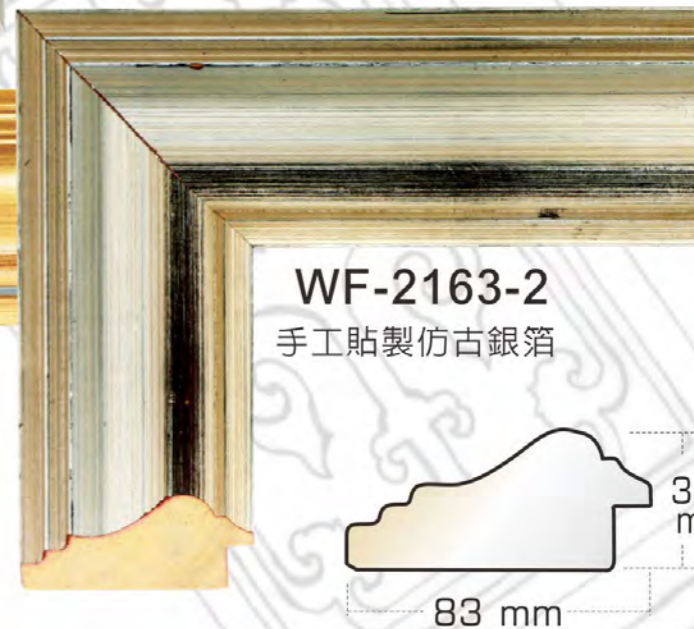

WF-2163-2 手工貼製仿古銀箔

■長度以10尺為主(3000mm)



WF-2159-1 手工貼製金箔揉紙技法



WF-2159-2 手工貼製銀箔揉紙技法

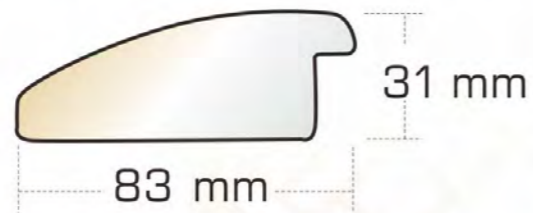

WF-2160-1 手工貼製雪花金箔技法

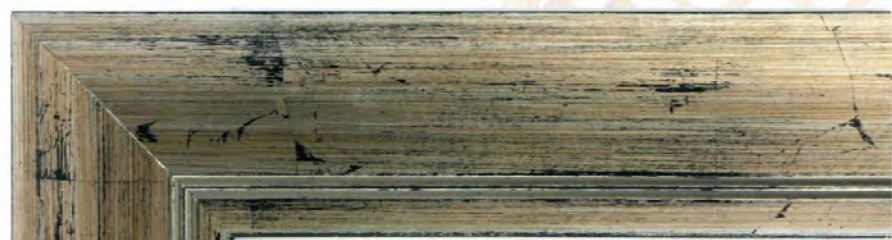

WF-2160-2 手工貼製銀箔揉紙技法



■長度以10尺為主(3000mm)



WF-2161-1 手工貼製雪花金箔技法



WF-2161-2 手工貼製雪花銀箔技法



WF-2162-1 彩裂漆金箔原色



WF-2162-2 彩裂漆銀箔原色

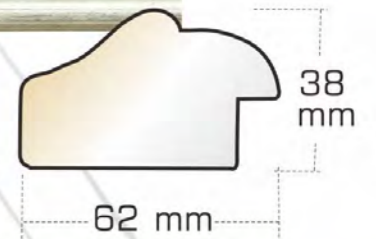

WF-2163-1 手工貼製仿古金箔

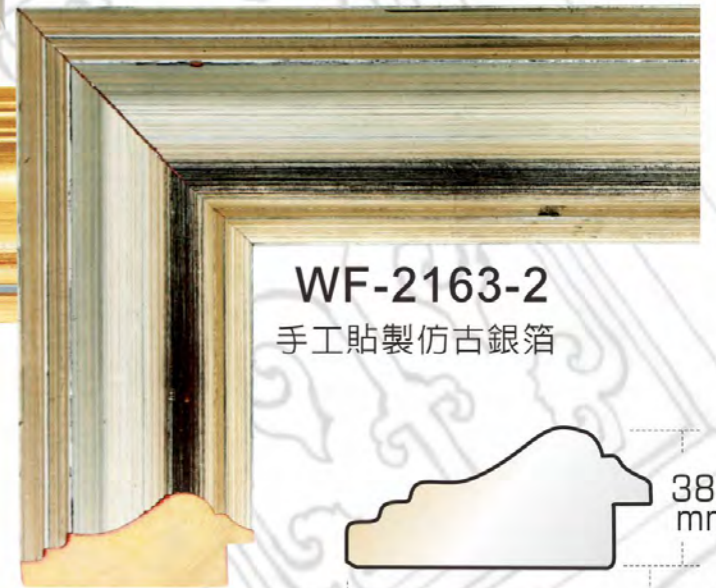

WF-2163-2 手工貼製仿古銀箔

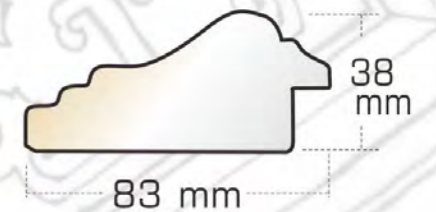

■長度以10尺為主(3000mm)



WF-2171-1 手工貼製香檳金箔



WF-2171-2 手工貼製香檳銀箔



WF-2172-1 手工貼製仿古金箔



WF-2172-2 手工貼製仿古銀箔



■長度以10尺為主(3000mm)



WF-2173-1 手工貼製仿古金箔



WF-2173-2 手工貼製仿古銀箔



WF-2175-1 手工貼製仿古金箔



WF-2175-2 手工貼製仿古銀箔



■長度以10尺為主(3000mm)



WF-2102-1
手工貼製仿古金箔

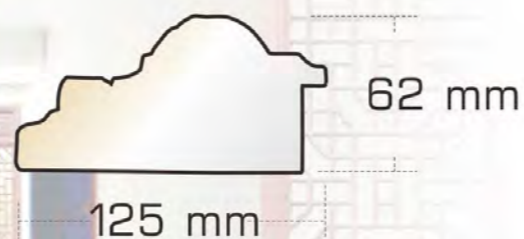

WF-2103-1
手工貼製仿古金箔

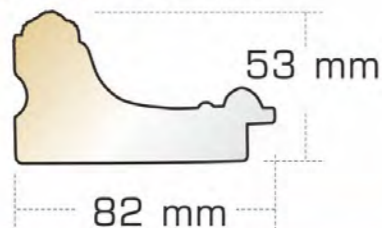

WF-2105-1
手工貼製仿古金箔



WF-2106-1
手工貼製仿古金箔



WF-2103-2
手工貼製仿古銀箔



WF-2105-2
手工貼製仿古銀箔

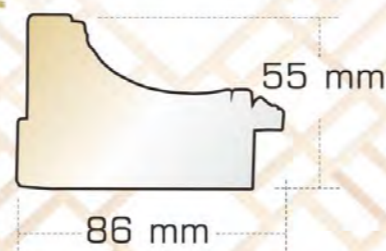

WF-2106-2
手工貼製仿古銀箔

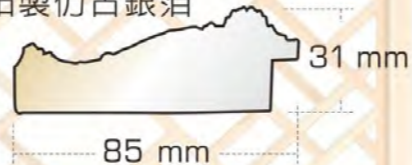

■長度以10尺為主(3000mm)



WF-2107-1
手工貼製仿古金箔

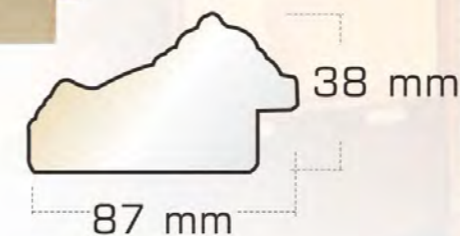

WF-2107-2
手工貼製仿古銀箔



WF-2108-1
手工貼製仿古金箔



WF-2108-2
手工貼製仿古銀箔

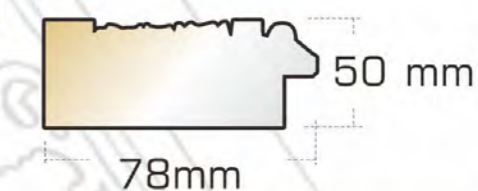

WF-2109-1
手工貼製仿古金箔



WF-2109-2
手工貼製仿古銀箔

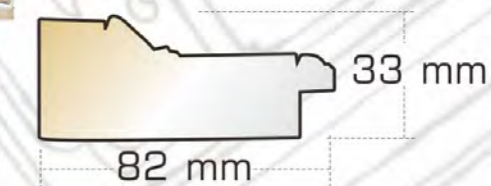

■長度以10尺為主(3000mm)

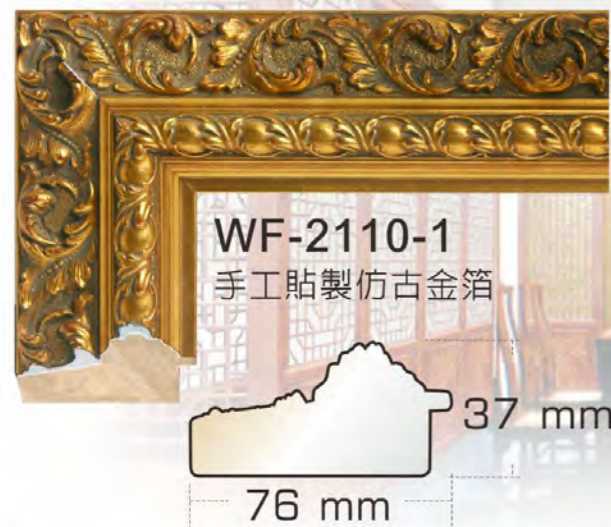

■長度以10尺為主(3000mm)

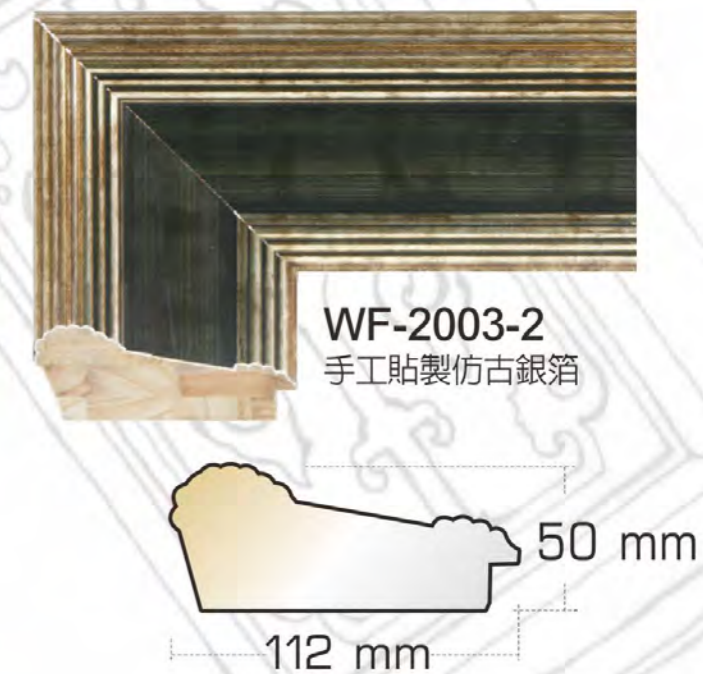
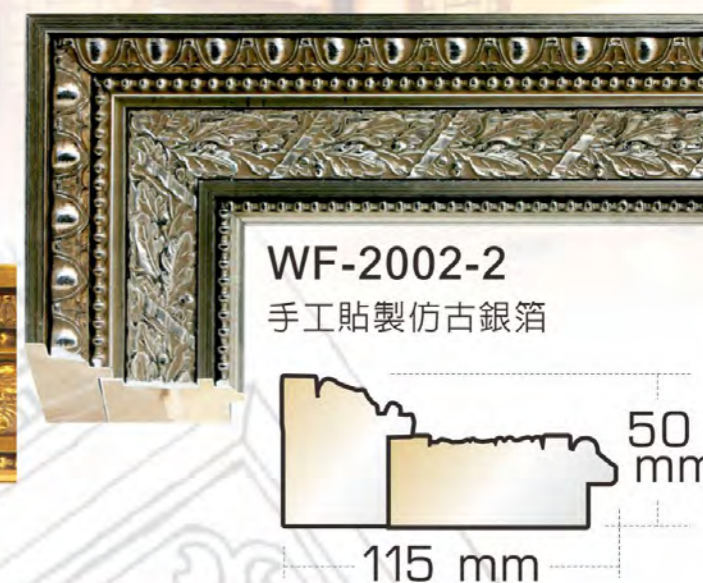
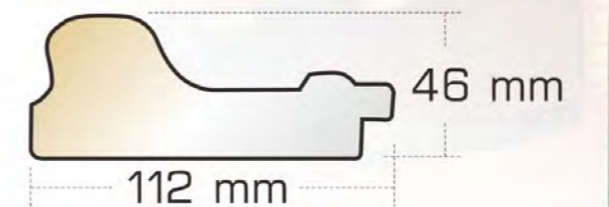

■長度以10尺為主(3000mm)



WF-2005-1
手工貼製仿古金箔



WF-2005-2
手工貼製仿古銀箔

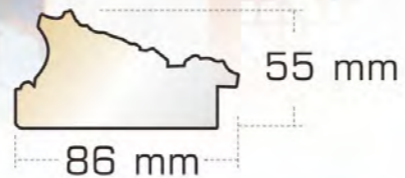

WF-2006-1
手工貼製仿古金箔



WF-2006-2
手工貼製仿古銀箔

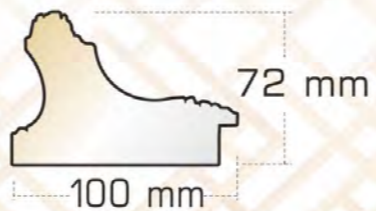

WF-2007-1
手工貼製仿古金箔

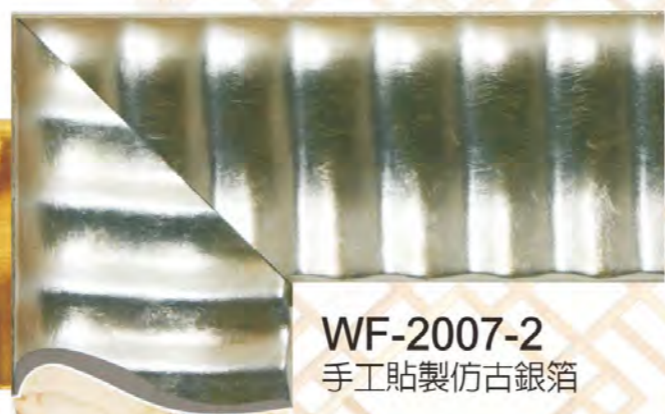

WF-2007-2
手工貼製仿古銀箔

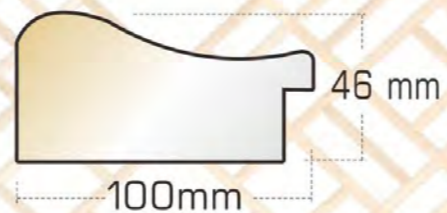

■長度以10尺為主(3000mm)



WF-2008-1
手工貼製仿古金箔

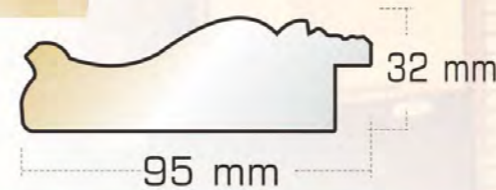

WF-2008-2
手工貼製仿古銀箔



WF-2010-1
手工貼製仿古金箔



WF-2010-2
手工貼製仿古銀箔

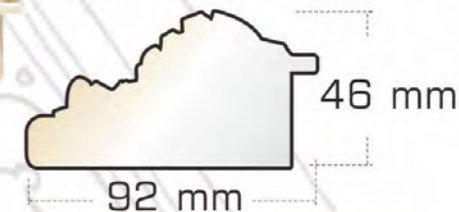

WF-2011-1
手工貼製仿古金箔

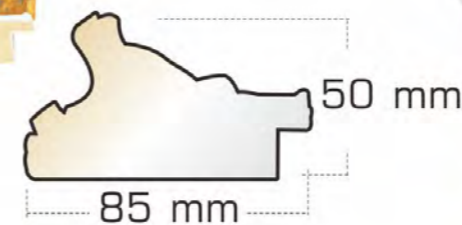

WF-2011-2
手工貼製仿古銀箔

■ 長度以10尺為主(3000mm)

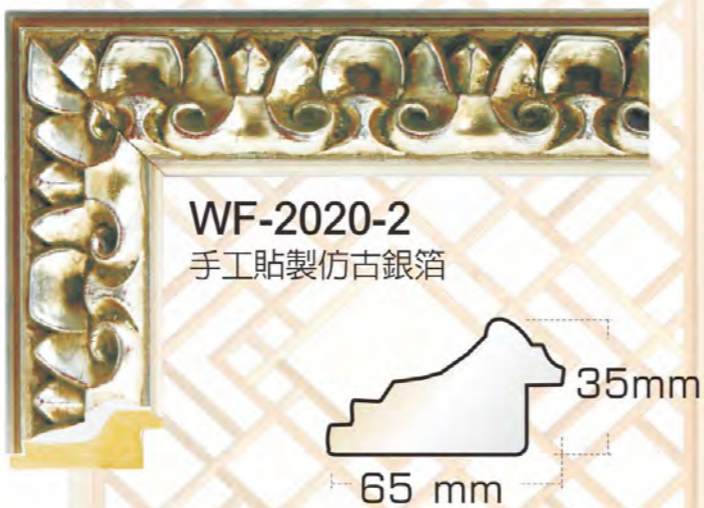
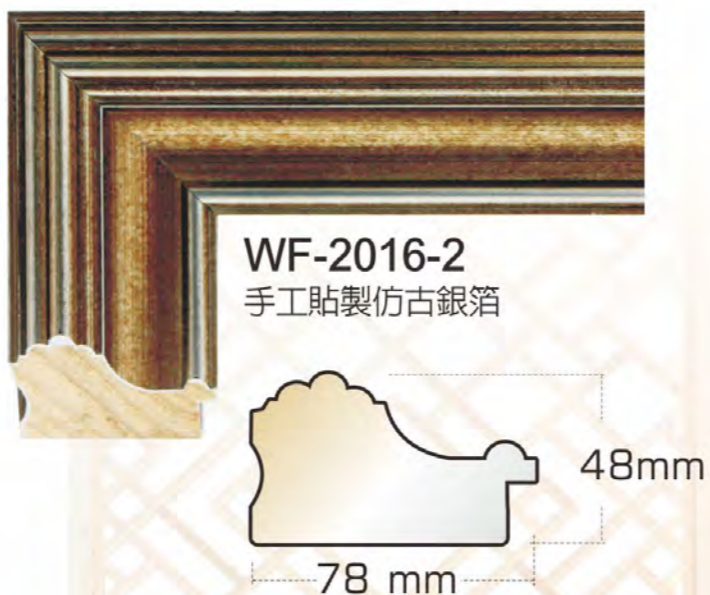
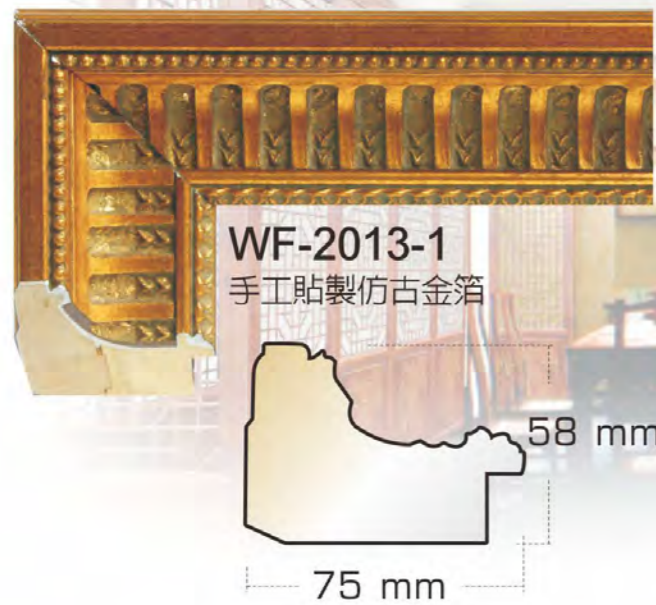

■ 長度以10尺為主(3000mm)

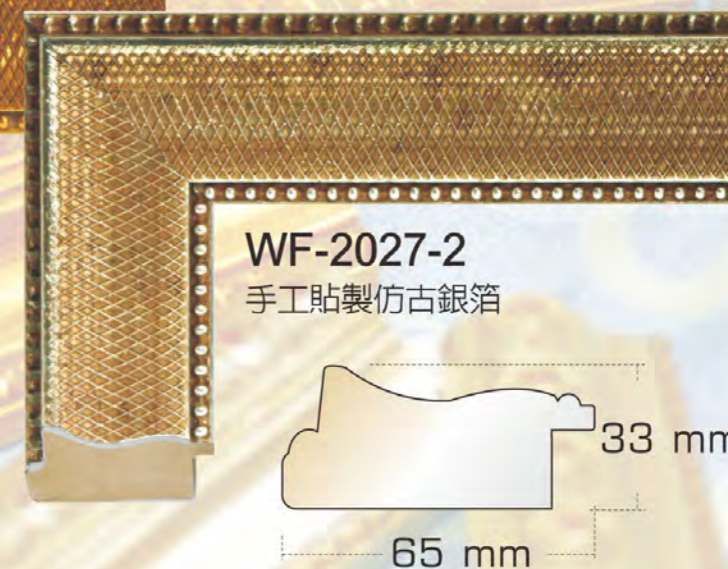

■ 長度以10尺為主(3000mm)



■ 長度以10尺為主(3000mm)

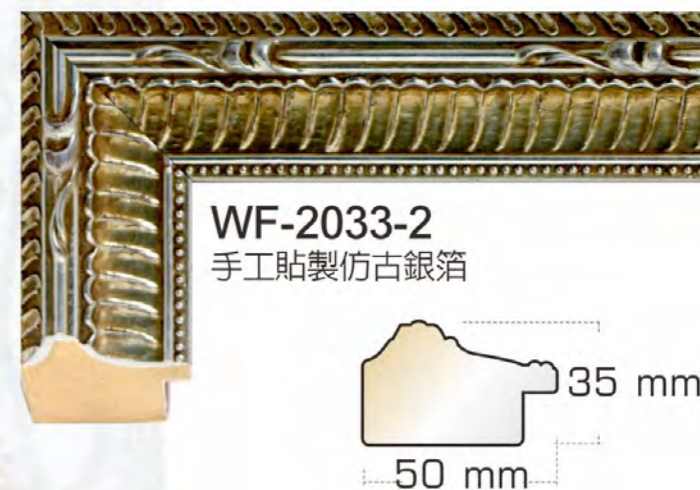

■長度以10尺為主(3000mm)

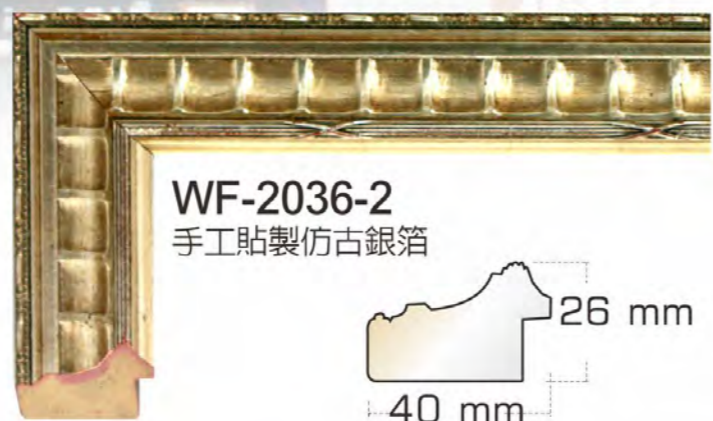

■長度以10尺為主(3000mm)

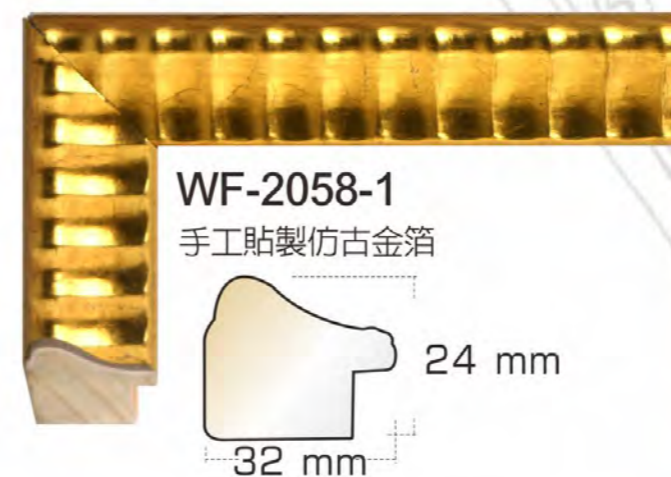
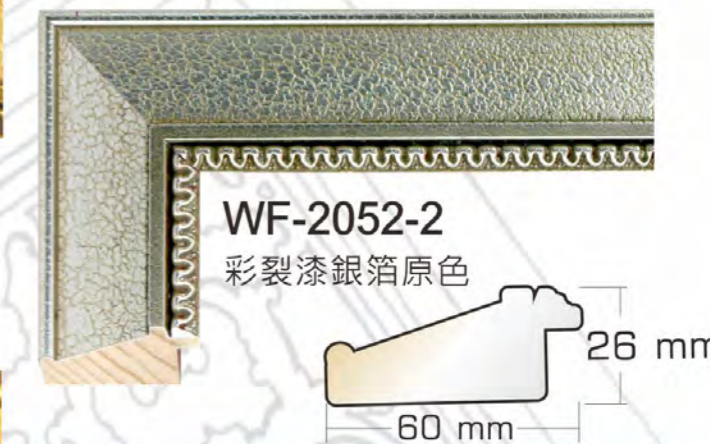
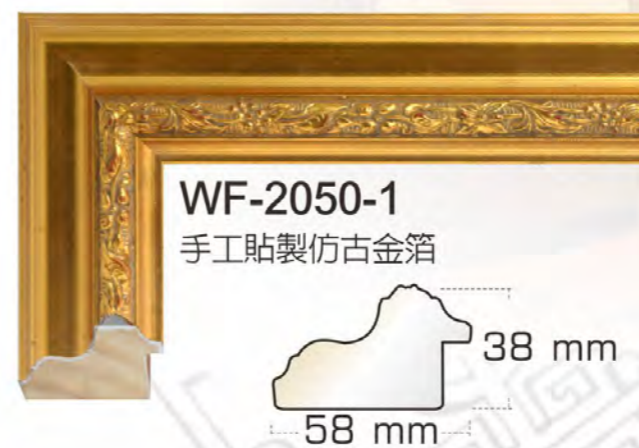
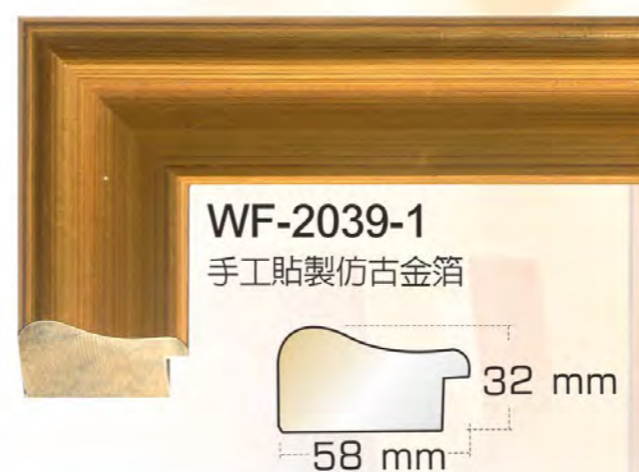

■長度以10尺為主(3000mm)

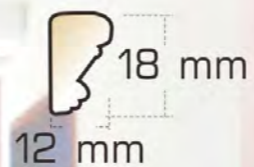

WF-2062-1
手工貼製仿古金箔



WF-2065-2
手工貼製銀箔揉紙技法



WF-2069-2
手工貼製仿古銀箔



WF-2070-2
手工貼製仿古銀箔

■長度以10尺為主(3000mm)



WF-2073-1
手工貼製仿古金箔

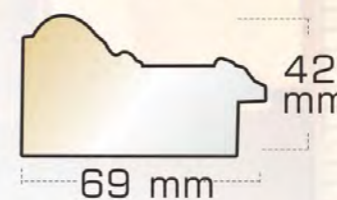

WF-2073-2
手工貼製仿古銀箔



WF-2075-1
手工貼製仿古金箔



WF-2075-2
手工貼製仿古銀箔



WF-2076-1
手工貼製仿古金箔

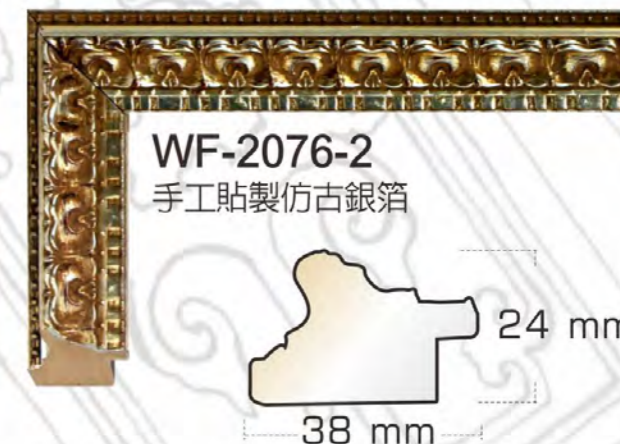

WF-2076-2
手工貼製仿古銀箔

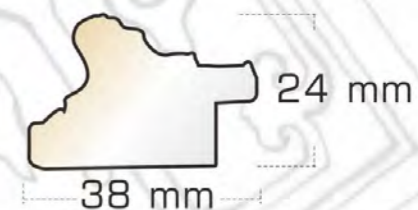

■ 長度以8尺為主(2400mm)

鑽石條



WF-013-1
手工貼製金箔原色
寬6CMX厚18MM



WF-013-2
手工貼製銀箔原色
寬6CMX厚18MM



WF-013-3
手工貼製仿古金箔
寬6CMX厚18MM



WF-013-5
手工貼製仿古銀箔
寬6CMX厚18MM



草繩編織線板

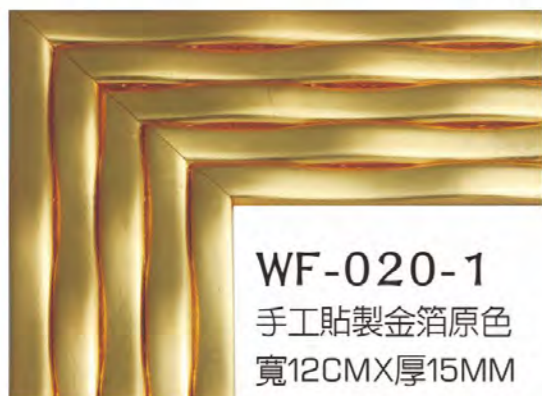

WF-020-1
手工貼製金箔原色
寬12CMX厚15MM

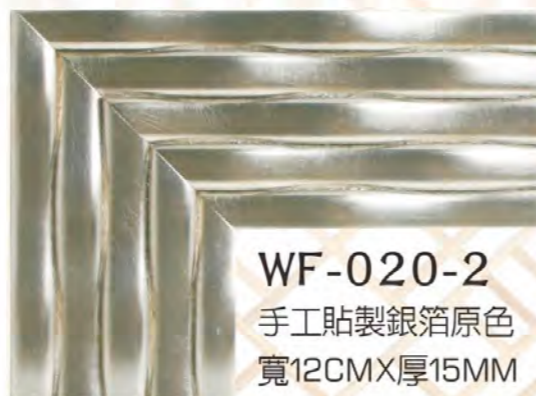

WF-020-2
手工貼製銀箔原色
寬12CMX厚15MM

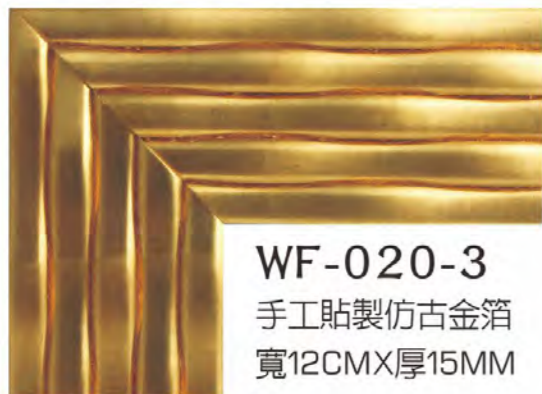

WF-020-3
手工貼製仿古金箔
寬12CMX厚15MM

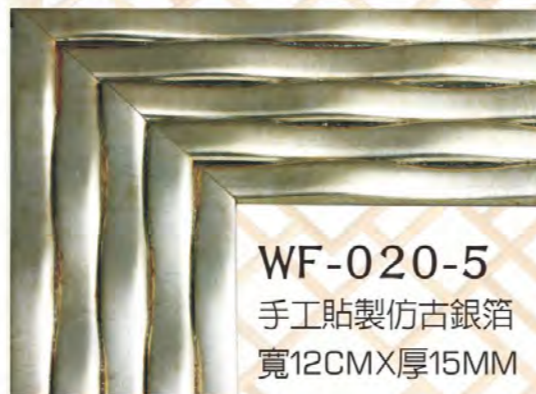

WF-020-5
手工貼製仿古銀箔
寬12CMX厚15MM



DL-8201

雙面雕花(台灣製)

尺寸：長X寬X厚

廠規：231CM X 75CM X 3.6CM (±0.5CM)

樹種：松木，不含油漆

肚板樹種-松木

內線條尺寸：面寬X面高

1.5CM X 1.8CM (±0.1CM)

接受訂製
客製化



DL-8202

雙面雕花(台灣製)

尺寸：長X寬X厚

廠規：231CM X 75CM X 3.6CM (±0.5CM)

樹種：松木，不含油漆

肚板樹種-松木

內線條尺寸：面寬X面高

1.5CM X 1.8CM (±0.1CM)



DL-8203

雙面雕花(台灣製)

尺寸：長 X 寬 X 厚

廠規：231CM X 75CM X 3.6CM (±0.5CM)

樹種：松木，不含油漆

肚板樹種-松木

內線條尺寸：面寬 X 面高
1.5CM X 1.8CM (±0.1CM)

接受訂製
客製化



DL-8204

雙面雕花(台灣製)

尺寸：長 X 寬 X 厚

廠規：231CM X 75CM X 3.6CM (±0.5CM)

樹種：松木，不含油漆

肚板樹種-松木

內線條尺寸：面寬 X 面高
1.5CM X 1.8CM (±0.1CM)



DL-8205

雙面雕花(台灣製)

尺寸：長 X 寬 X 厚

廠規：231CM X 75CM X 3.6CM (±0.5CM)

樹種：松木，不含油漆

肚板樹種-松木

內線條尺寸：面寬 X 面高
1.5CM X 1.8CM (±0.1CM)

接受訂製
客製化



DL-8206

雙面雕花(台灣製)

尺寸：長 X 寬 X 厚

廠規：231CM X 75CM X 3.6CM (±0.5CM)

樹種：松木，不含油漆

肚板樹種-松木

內線條尺寸：面寬 X 面高
1.5CM X 1.8CM (±0.1CM)



DL-8207

雙面雕花(台灣製)

尺寸：長 X 寬 X 厚

廠規：234CM X 75CM X 3.6CM (±0.5CM)

樹種：松木，不含油漆

肚板樹種-松木

內線條尺寸：面寬 X 面高

1.5CM X 1.8CM (±0.1CM)

接受訂製
客製化

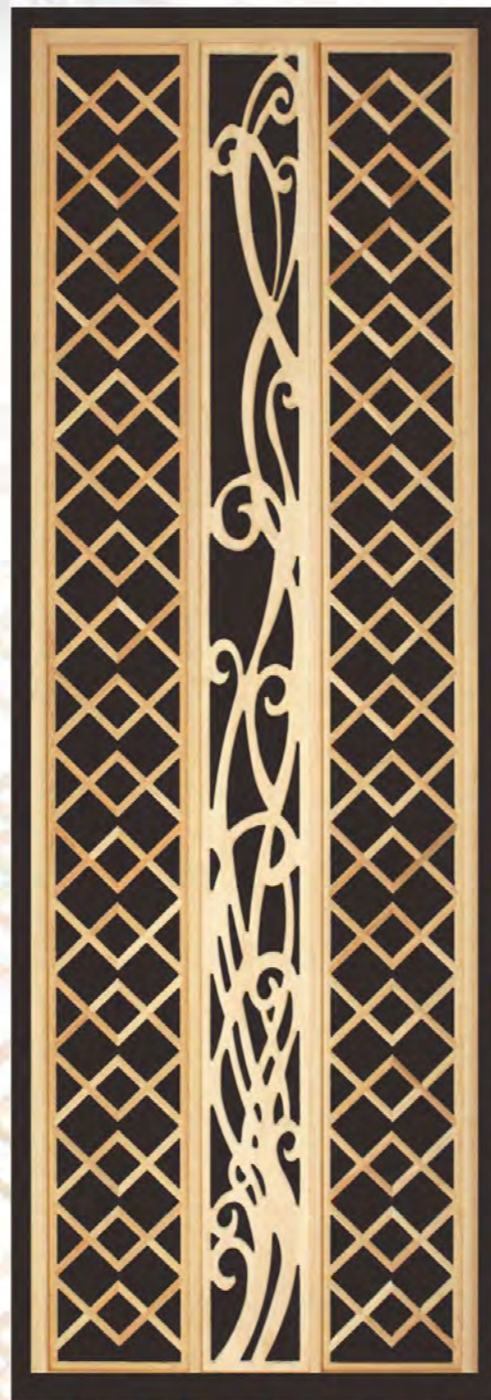

DL-8208

雙面雕花(台灣製)

尺寸：長 X 寬 X 厚

廠規：234CM X 75CM X 3.6CM (±0.5CM)

樹種：松木，不含油漆

肚板樹種-松木

內線條尺寸：面寬 X 面高

1.5CM X 1.8CM (±0.1CM)



DL-8209

雙面雕花(台灣製)

尺寸：長 X 寬 X 厚

廠規：234CM X 75CM X 3.6CM (±0.5CM)

樹種：松木，不含油漆

肚板樹種-松木

內線條尺寸：面寬 X 面高

1.5CM X 1.8CM (±0.1CM)

接受訂製
客製化



DL-8210

雙面雕花(台灣製)

尺寸：長 X 寬 X 厚

廠規：234CM X 75CM X 3.6CM (±0.5CM)

樹種：松木，不含油漆

肚板樹種-松木

內線條尺寸：面寬 X 面高

1.5CM X 1.8CM (±0.1CM)



DL-8211

雙面雕花(台灣製)

尺寸：長 X 寬 X 厚

廠規：234CM X 75CM X 3.6CM (±0.5CM)

樹種：松木，不含油漆

肚板樹種-松木

內線條尺寸：面寬 X 面高

1.5CM X 1.8CM (±0.1CM)

接受訂製
客製化



DL-8212

雙面雕花(台灣製)

尺寸：長 X 寬 X 厚

廠規：234CM X 75CM X 3.6CM (±0.5CM)

樹種：松木，不含油漆

肚板樹種-松木

內線條尺寸：面寬 X 面高

1.5CM X 1.8CM (±0.1CM)

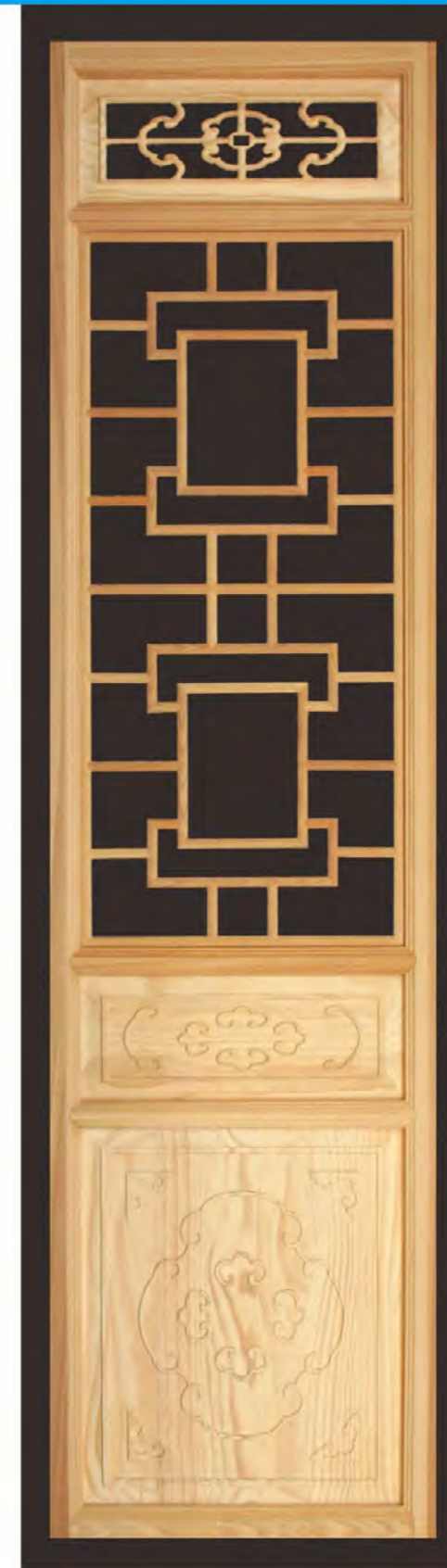

DL-8213

雙面雕花(台灣製)

尺寸：長 X 寬 X 厚

廠規：215CM X 55CM X 3.6CM (±0.5CM)

樹種：松木，不含油漆

肚板樹種-松木

內線條尺寸：面寬 X 面高

1.5CM X 1.8CM (±0.1CM)

接受訂製
客製化

DL-8214

雙面雕花(台灣製)

尺寸：長 X 寬 X 厚

廠規：211CM X 60CM X 1.8CM (±0.5CM)

樹種：松木，不含油漆





DL-8215

雙面雕花(台灣製)

尺寸：長 X 寬 X 厚

廠規：212CM X 32CM X 1.8CM (±0.5CM)

樹種：松木，不含油漆

接受訂製
客製化



DL-8216

雙面雕花(台灣製)

尺寸：長 X 寬 X 厚

廠規：170CM X 60CM X 1.8CM (±0.5CM)

樹種：松木，不含油漆



時尚簡約造型鏤空板

DL-8217

雙面雕花(台灣製)

尺寸：長 X 寬 X 厚

廠規：60CM X 60CM X 1.8CM (±0.5CM)

樹種：松木，不含油漆

接受訂製
客製化

時尚簡約 | 鏤空雕刻板



時尚簡約鏤空雕刻板

DL-8219

雙面雕花(台灣製)

尺寸：長 X 寬 X 厚

廠規：60CM X 60CM X 1.8CM (±0.5CM)

樹種：松木，不含油漆

接受訂製
客製化



時尚簡約造型鏤空板

DL-8218

雙面雕花(台灣製)

尺寸：長 X 寬 X 厚

廠規：190CM X 47CM X 1.8CM (±0.5CM)

樹種：松木，不含油漆

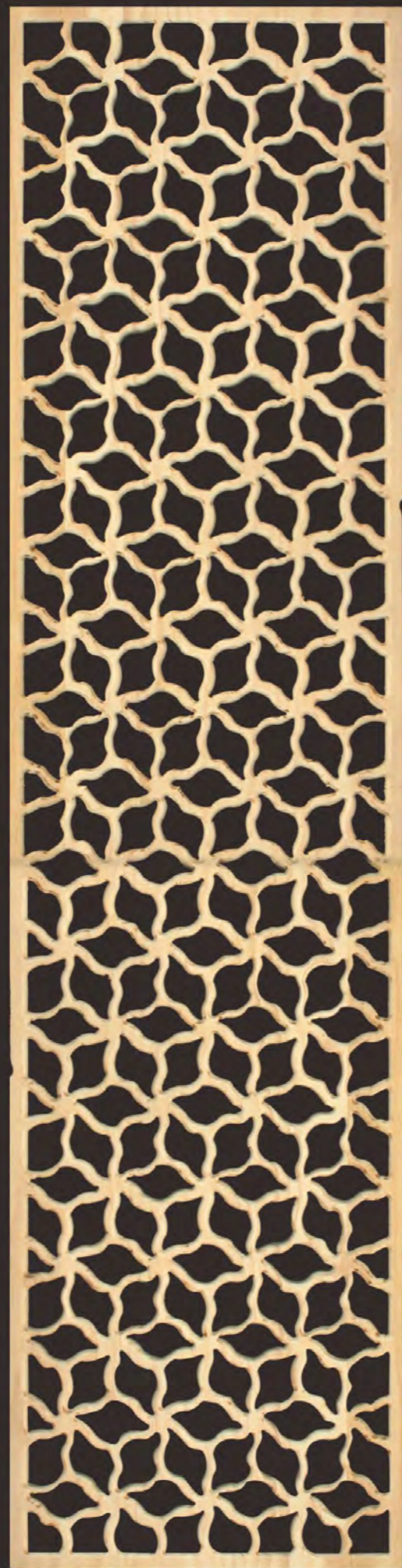

仿古窗花窗櫺

DL-8101

雙面雕花(台灣製)

尺寸：長 X 寬 X 厚

廠規：210CM X 50CM X 3.6CM (±0.5CM)

樹種：松木，不含油漆

肚板樹種-松木

內線條尺寸：面寬 X 面高

1.2CM X 1.8CM (±0.1CM)

接受訂製
客製化





DL-8102

雙面雕花(台灣製)

尺寸：長 X 寬 X 厚

廠規：206CM X 40CM X 3.6CM (±0.5CM)

樹種：松木，不含油漆

肚板樹種-松木

內線條尺寸：面寬 X 面高

1.2CM X 1.8CM (±0.1CM)

接受訂製
客製化



DL-8103

雙面雕花(台灣製)

尺寸：長 X 寬 X 厚

廠規：206CM X 45CM X 3.6CM (±0.5CM)

樹種：松木，不含油漆

肚板樹種-松木

內線條尺寸：面寬 X 面高

1.2CM X 1.8CM (±0.1CM)

接受訂製
客製化





DL-8104

雙面雕花(台灣製)

尺寸：長 X 寬 X 厚

廠規：210CM X 50CM X 3.6CM (±0.5CM)

樹種：松木，不含油漆

肚板樹種-松木

內線條尺寸：面寬 X 面高

1.2CM X 1.8CM (±0.1CM)

接受訂製
客製化

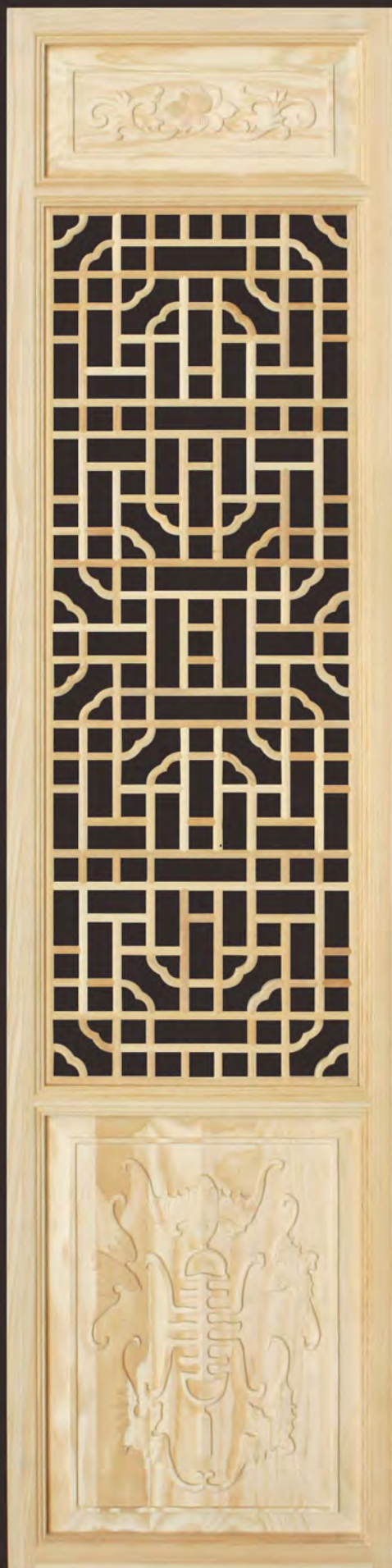

DL-8105

雙面雕花(台灣製)

尺寸：長 X 寬 X 厚

廠規：210CM X 47CM X 3.6CM (±0.5CM)

樹種：松木，不含油漆

肚板樹種-松木

內線條尺寸：面寬 X 面高

1.5CM X 1.8CM (±0.1CM)

接受訂製
客製化



DL-8106

雙面雕花(台灣製)

尺寸：長 X 寬 X 厚

廠規：210CM X 45CM X 3.6CM (±0.5CM)

樹種：松木，不含油漆

肚板樹種-松木

內線條尺寸：面寬 X 面高

1.5CM X 1.8CM (±0.1CM)

客製化
台灣製



DL-8107

單面雕花

尺寸：長 X 寬 X 厚

120CM X 80CM X 3CM (±0.5CM)

樹種：榆木 仿柚木色，霧面平光漆



手工雕花放大圖





手工雕花放大圖



仿古窗花窗櫺

DL-8108

單面雕花

尺寸：長 X 寬 X 厚
100CM X 100CM X 3CM (±0.5CM)
樹種：榆木 仿柚木色，霧面平光漆
內線條尺寸：面寬 X 面高
1CM X 1.7CM (±0.3CM)

仿古窗花窗櫺

DL-8109

單面雕花

尺寸：長 X 寬 X 厚
90CM X 90CM X 3CM (±0.5CM)
樹種：榆木 仿柚木色，
霧面平光漆



仿古窗花窗櫺

DL-8110

單面雕花

尺寸：長 X 寬 X 厚
92CM X 92CM X 3CM (±0.5CM)
樹種：榆木 仿柚木色，霧面平光漆
內線條尺寸：面寬 X 面高
1CM X 1.7CM (±0.3CM)





富春居

臺灣製造

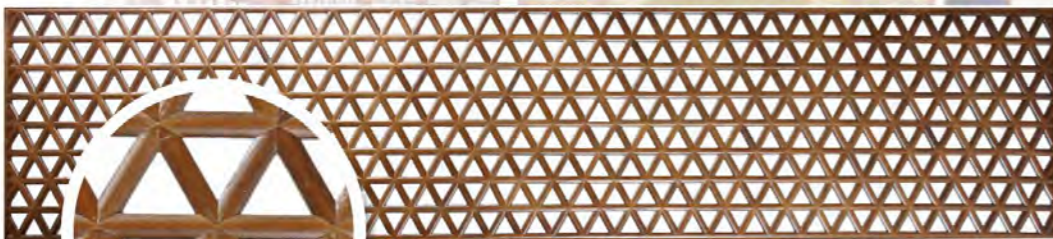

DL-8001
雙面雕花 尺寸：長X寬X厚
230CM X 60CM X 1.8CM (±0.5CM)
樹種：天然松木、不含油漆
內線條尺寸：面寬X面高
1.5CM X 1.8CM (±0.3CM)

平圓形

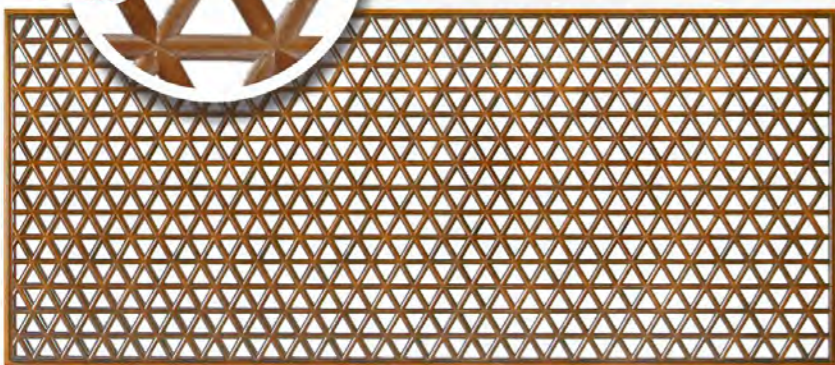

DL-8002 臺灣製造
雙面雕花 尺寸：長X寬X厚
210CM X 90CM X 1.8CM (±0.5CM)
樹種：榆木 仿柚木色，霧面平光漆
內線條尺寸：面寬X面高
1.5CM X 1.8CM (±0.3CM)

主題



臺灣製造

DL-8003
雙面雕花 尺寸：長X寬X厚
230CM X 60CM X 1.8CM (±0.5CM)
樹種：榆木 仿柚木色，霧面平光漆
內線條尺寸：面寬X面高
1.4CM X 1.8CM (±0.3CM)

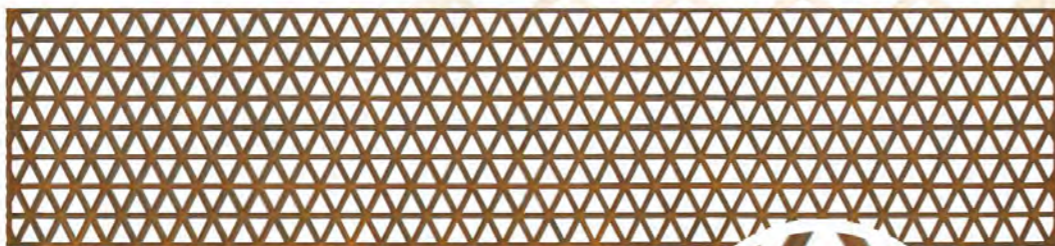

六角形

DL-8004
雙面雕花 尺寸：長X寬X厚
210CM X 90CM X 1.8CM (±0.5CM)
樹種：榆木 仿柚木色，霧面平光漆
內線條尺寸：面寬X面高
1.4CM X 1.8CM (±0.3CM)

臺灣製造

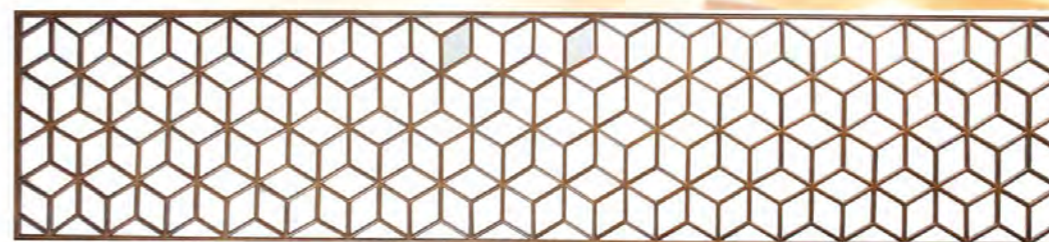
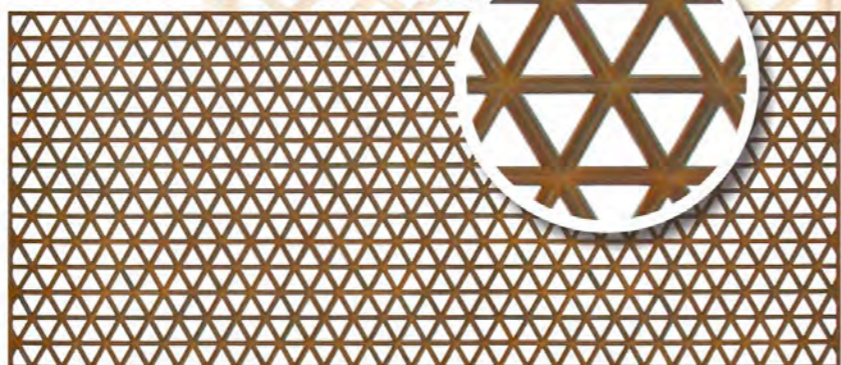

DL-8007 臺灣製造
雙面雕花 尺寸：長X寬X厚
230CM X 60CM X 1.8CM (±0.5CM)
樹種：榆木 仿柚木色，霧面平光漆
內線條尺寸：面寬X面高
1.5CM X 1.8CM (±0.3CM)

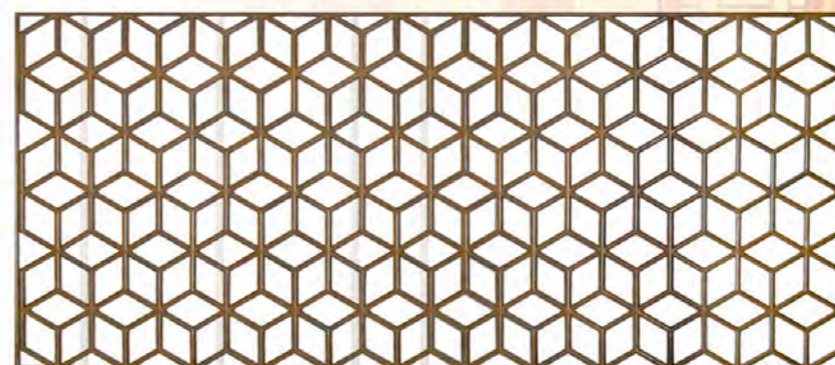

DL-8008
雙面雕花 尺寸：長X寬X厚
210CM X 90CM X 1.8CM (±0.5CM)
樹種：榆木 仿柚木色，霧面平光漆
內線條尺寸：面寬X面高
1.5CM X 1.8CM (±0.3CM)

臺灣製造



藝境



百富



DL-8009 臺灣製造
雙面雕花 尺寸：長X寬X厚
230CM X 60CM X 1.8CM (±0.5CM)
樹種：榆木 仿柚木色，霧面平光漆
內線條尺寸：面寬X面高
1.5CM X 1.8CM (±0.3CM)

DL-8010 臺灣製造
雙面雕花 尺寸：長X寬X厚
210CM X 90CM X 1.8CM (±0.5CM)
樹種：榆木 仿柚木色，霧面平光漆
內線條尺寸：面寬X面高
1.5CM X 1.8CM (±0.3CM)

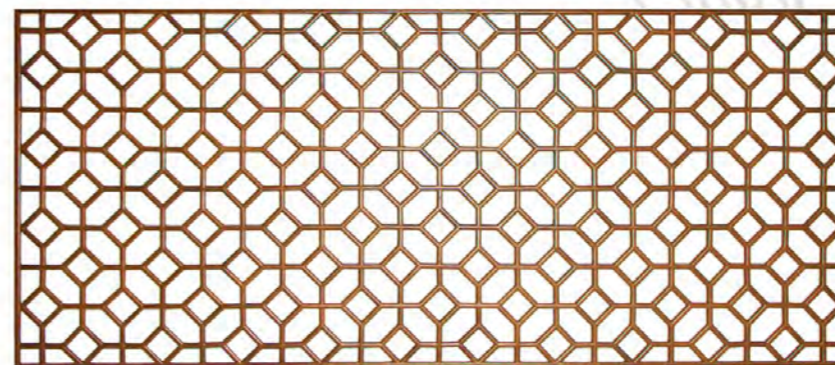

臺灣製造

DL-8011

雙面雕花 尺寸：長X寬X厚
230CM X 60CM X 1.8CM (±0.5CM)
樹種：榆木 仿柚木色，霧面平光漆
內線條尺寸：面寬X面高
1.5CM X 1.8CM (±0.3CM)



DL-8012

雙面雕花 尺寸：長X寬X厚
210CM X 90CM X 1.8CM (±0.5CM)
樹種：榆木 仿柚木色，霧面平光漆
內線條尺寸：面寬X面高
1.5CM X 1.8CM (±0.3CM)

臺灣製造



經典



林園

DL-8013

雙面雕花 尺寸：長X寬X厚
230CM X 60CM X 1.8CM (±0.5CM)
樹種：榆木 仿柚木色，霧面平光漆
內線條尺寸：面寬X面高
1CM X 1.8CM (±0.3CM)

臺灣製造

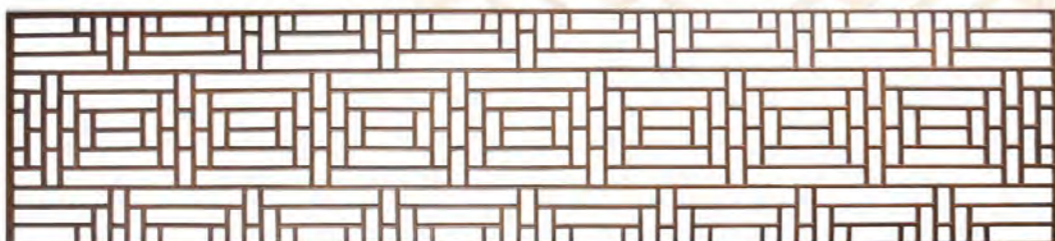

DL-8014

雙面雕花 尺寸：長X寬X厚
210CM X 90CM X 1.8CM (±0.5CM)
樹種：榆木 仿柚木色，霧面平光漆
內線條尺寸：面寬X面高
1CM X 1.8CM (±0.3CM)

臺灣製造

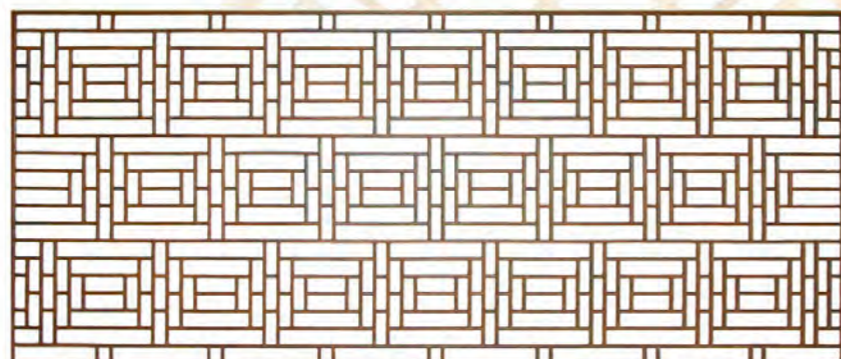

DL-8015

雙面雕花 尺寸：長X寬X厚
230CM X 60CM X 1.8CM (±0.5CM)
樹種：榆木 仿柚木色，霧面平光漆
內線條尺寸：面寬X面高
1.5CM X 1.8CM (±0.3CM)

臺灣製造



DL-8016

雙面雕花 尺寸：長X寬X厚
210CM X 90CM X 1.8CM (±0.5CM)
樹種：榆木 仿柚木色，霧面平光漆
內線條尺寸：面寬X面高
1.5CM X 1.8CM (±0.3CM)

臺灣製造

簡約

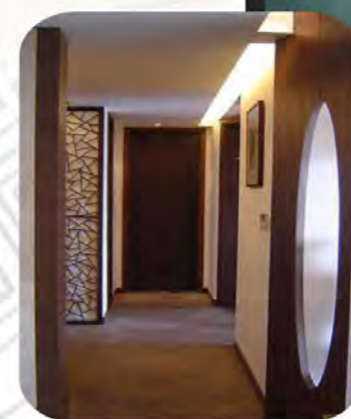

江南風



DL-8017

雙面雕花 尺寸：長X寬X厚
230CM X 60CM X 1.8CM (±0.5CM)
樹種：榆木 仿柚木色，霧面平光漆
內線條尺寸：面寬X面高
1.5CM X 1.8CM (±0.3CM)

臺灣製造

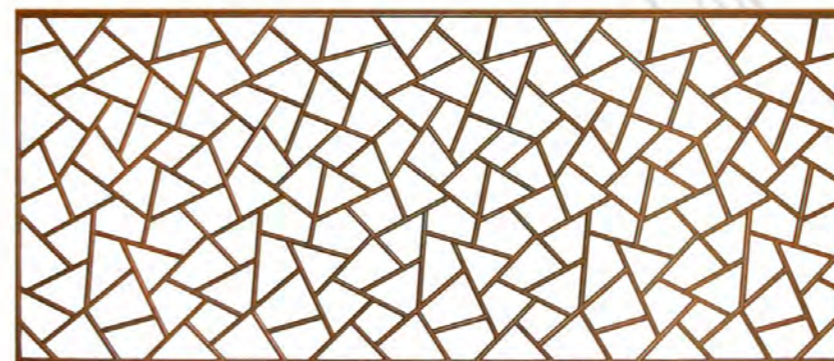

DL-8018

雙面雕花 尺寸：長X寬X厚
210CM X 90CM X 1.8CM (±0.5CM)
樹種：榆木 仿柚木色，霧面平光漆
內線條尺寸：面寬X面高
1.5CM X 1.8CM (±0.3CM)

臺灣製造

臺灣製造

臺灣製造

DL-8019

雙面雕花 尺寸：長X寬X厚
230CM X 60CM X 1.8CM (±0.5CM)
樹種：榆木 仿柚木色，霧面平光漆
內線條尺寸：面寬X面高
1.5CM X 1.8CM (±0.3CM)



DL-8020

雙面雕花 尺寸：長X寬X厚
210CM X 90CM X 1.8CM (±0.5CM)
樹種：榆木 仿柚木色，霧面平光漆
內線條尺寸：面寬X面高
1.5CM X 1.8CM (±0.3CM)



臺灣製造



鵲踏枝

極緻



DL-8021 臺灣製造

雙面雕花 尺寸：長X寬X厚
230CM X 60CM X 1.8CM (±0.5CM)
樹種：榆木 仿柚木色，霧面平光漆
內線條尺寸：面寬X面高
1.5CM X 1.8CM (±0.3CM)



DL-8022

雙面雕花 尺寸：長X寬X厚
210CM X 90CM X 1.8CM (±0.5CM)
樹種：榆木 仿柚木色，霧面平光漆
內線條尺寸：面寬X面高
1.5CM X 1.8CM (±0.3CM)

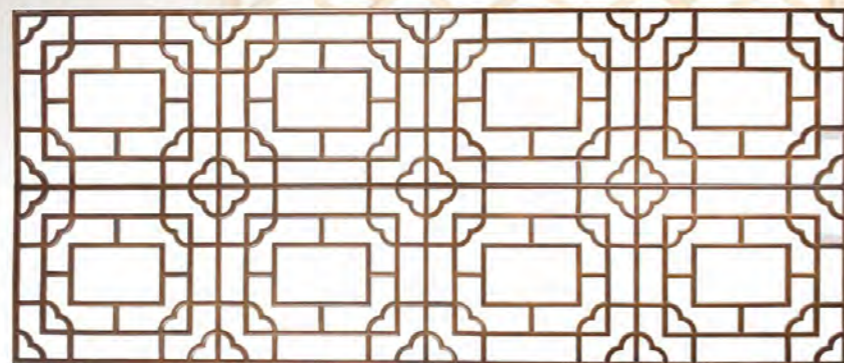

臺灣製造

~80~

圖案僅供參考，手工打造，請以實品為主。



DL-8023 臺灣製造

雙面雕花 尺寸：長X寬X厚
230CM X 60CM X 1.8CM (±0.5CM)
樹種：榆木 仿柚木色，霧面平光漆
內線條尺寸：面寬X面高
1.5CM X 1.8CM (±0.3CM)

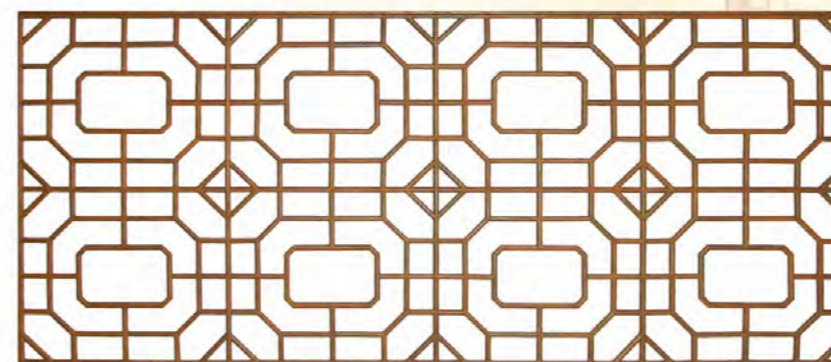

DL-8024

雙面雕花 尺寸：長X寬X厚
210CM X 90CM X 1.8CM (±0.5CM)
樹種：榆木 仿柚木色，霧面平光漆
內線條尺寸：面寬X面高
1.5CM X 1.8CM (±0.3CM)

臺灣製造



自然



禪風

DL-8025

雙面雕花 尺寸：長X寬X厚
230CM X 60CM X 1.8CM (±0.5CM)
樹種：榆木 仿柚木色，霧面平光漆
內線條尺寸：面寬X面高
1.5CM X 1.8CM (±0.3CM)

臺灣製造



DL-8026

雙面雕花 尺寸：長X寬X厚
210CM X 90CM X 1.8CM (±0.5CM)
樹種：榆木 仿柚木色，霧面平光漆
內線條尺寸：面寬X面高
1.5CM X 1.8CM (±0.3CM)

臺灣製造

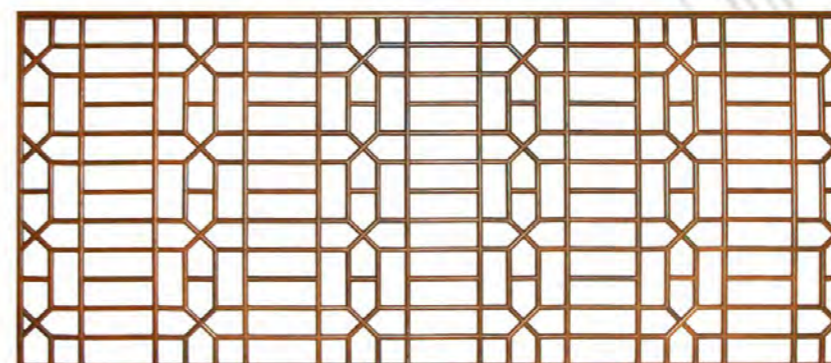

~81~

圖案僅供參考，手工打造，請以實品為主。

DL-8027 **臺灣製造**

雙面雕花 尺寸：長X寬X厚
230CM X 60CM X 1.8CM (±0.5CM)
樹種：榆木 仿柚木色，霧面平光漆
內線條尺寸：面寬X面高
1.5CM X 1.8CM (±0.3CM)



DL-8028 **臺灣製造**

雙面雕花 尺寸：長X寬X厚
210CM X 90CM X 1.8CM (±0.5CM)
樹種：榆木 仿柚木色，霧面平光漆
內線條尺寸：面寬X面高
1.5CM X 1.8CM (±0.3CM)

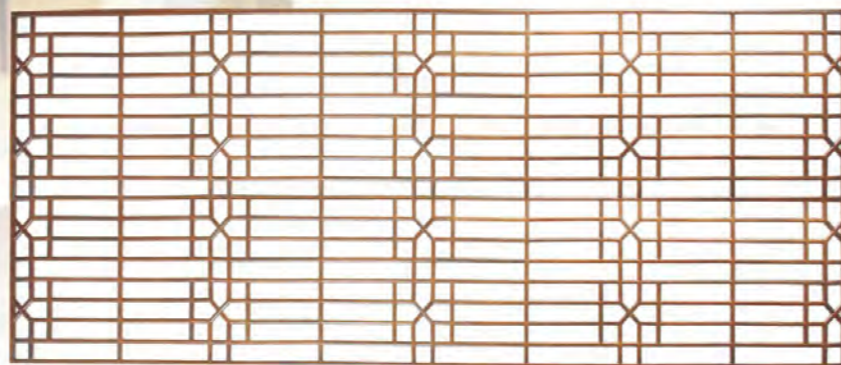

書田

得和



DL-8029 **臺灣製造**

雙面雕花 尺寸：長X寬X厚
230CM X 60CM X 1.8CM (±0.5CM)
樹種：榆木 仿柚木色，霧面平光漆
內線條尺寸：面寬X面高
1.5CM X 1.8CM (±0.3CM)



DL-8030

雙面雕花 尺寸：長X寬X厚
210CM X 90CM X 1.8CM (±0.5CM)
樹種：榆木 仿柚木色，霧面平光漆
內線條尺寸：面寬X面高
1.5CM X 1.8CM (±0.3CM)

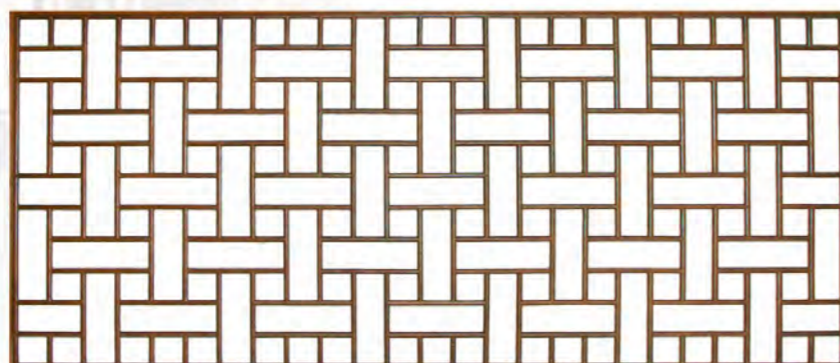

臺灣製造

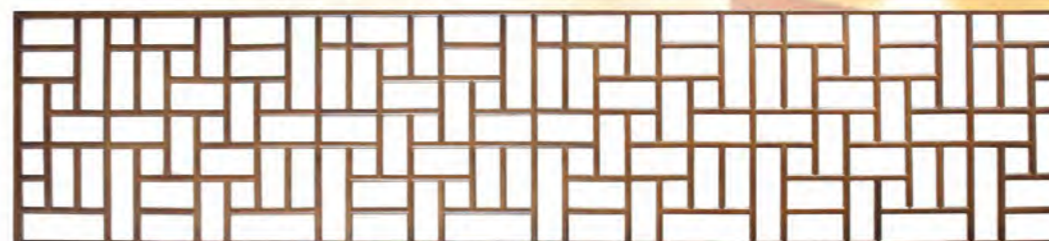

DL-8031 **臺灣製造**

雙面雕花 尺寸：長X寬X厚
230CM X 60CM X 1.8CM (±0.5CM)
樹種：榆木 仿柚木色，霧面平光漆
內線條尺寸：面寬X面高
1.5CM X 1.8CM (±0.3CM)

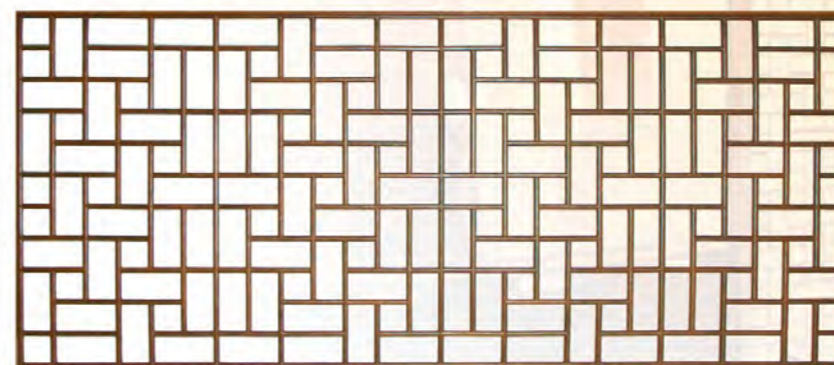

DL-8032

雙面雕花 尺寸：長X寬X厚
210CM X 90CM X 1.8CM (±0.5CM)
樹種：榆木 仿柚木色，霧面平光漆
內線條尺寸：面寬X面高
1.5CM X 1.8CM (±0.3CM)

臺灣製造



祥和



古藝

DL-8029 **臺灣製造**

雙面雕花 尺寸：長X寬X厚
230CM X 60CM X 1.8CM (±0.5CM)
樹種：榆木 仿柚木色，霧面平光漆
內線條尺寸：面寬X面高
1.5CM X 1.8CM (±0.3CM)

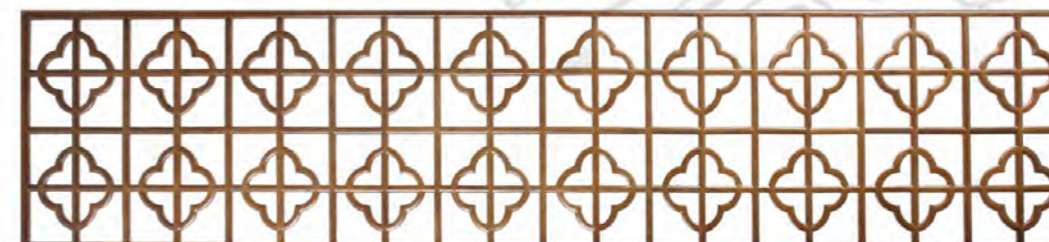

DL-8033

雙面雕花 尺寸：長X寬X厚
230CM X 60CM X 1.8CM (±0.5CM)
樹種：榆木 仿柚木色，霧面平光漆
內線條尺寸：面寬X面高
1.5CM X 1.8CM (±0.3CM)

臺灣製造

DL-8030

雙面雕花 尺寸：長X寬X厚
210CM X 90CM X 1.8CM (±0.5CM)
樹種：榆木 仿柚木色，霧面平光漆
內線條尺寸：面寬X面高
1.5CM X 1.8CM (±0.3CM)

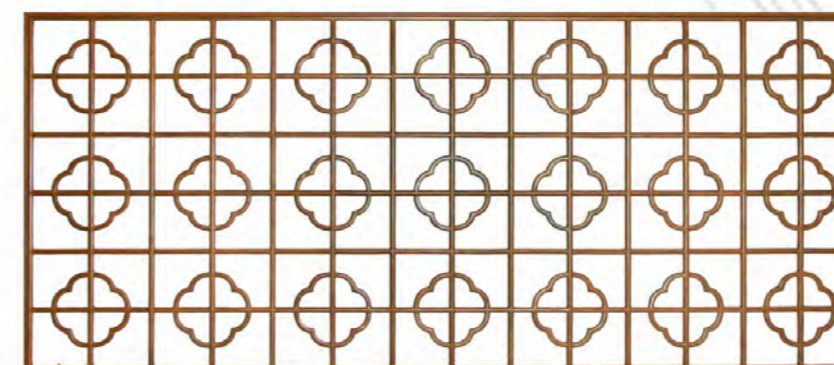

DL-8034

雙面雕花 尺寸：長X寬X厚
210CM X 90CM X 1.8CM (±0.5CM)
樹種：榆木 仿柚木色，霧面平光漆
內線條尺寸：面寬X面高
1.5CM X 1.8CM (±0.3CM)

臺灣製造



DL-8038

單面鏤空雕花尺寸：長 X 寬 X 厚
101CM X 41.5CM X 3CM (±0.5CM)
樹種：榆木 仿柚木色，霧面平光漆

DL-8037

雙面鏤空雕花 尺寸：長 X 寬 X 厚
180CM X 40CM X 1.8CM (±0.5CM)
樹種：榆木 仿柚木色，霧面平光漆



放大圖



DL-8042

單面鏤空雕花尺寸：長 X 寬 X 厚
103CM X 68CM X 3.5CM (±0.5CM)
樹種：榆木 仿柚木色，霧面平光漆
內線條尺寸：面寬 X 面高
1CM X 1.7CM (±0.3CM)



DL-8043

單面鏤空雕花尺寸：長 X 寬 X 厚
118CM X 46CM X 3.8CM (±0.5CM)
樹種：榆木 仿柚木色，霧面平光漆
內線條尺寸：面寬 X 面高
1CM X 1.7CM (±0.3CM)



DL-8044

單面鏤空雕花尺寸：長 X 寬 X 厚
138CM X 49.5CM X 4CM (±0.5CM)
樹種：榆木 仿柚木色，霧面平光漆
內線條尺寸：面寬 X 面高
1CM X 1.7CM (±0.3CM)

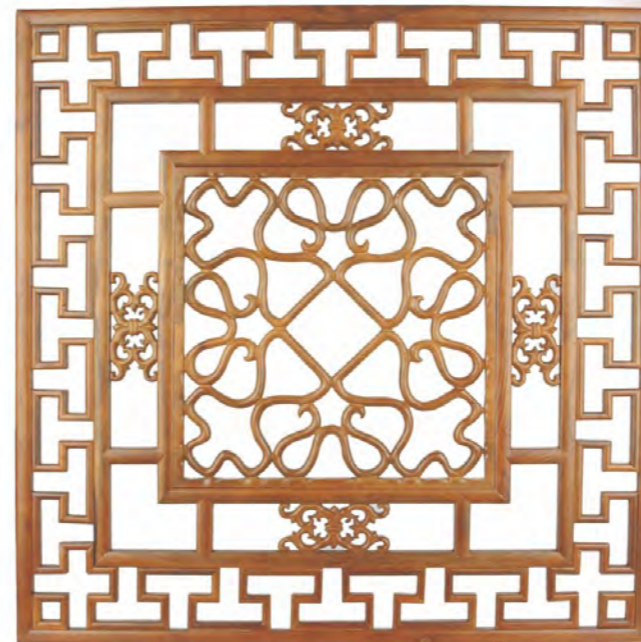

DL-8046

單面鏤空雕花尺寸：長 X 寬 X 厚
80CM X 80CM X 1.7CM (±0.5CM)
樹種：榆木 仿柚木色，霧面平光漆
內線條尺寸：面寬 X 面高
1CM X 1.7CM (±0.3CM)



DL-8045

單面鏤空雕花尺寸：長 X 寬 X 厚
80CM X 80CM X 3CM (±0.5CM)
樹種：榆木 仿柚木色，霧面平光漆
內線條尺寸：面寬 X 面高
1CM X 1.7CM (±0.3CM)



DL-8047

單面鏤空雕花尺寸：長 X 寬 X 厚
80CM X 80CM X 3CM (±0.5CM)
樹種：榆木 仿柚木色，霧面平光漆
內線條尺寸：面寬 X 面高
1.5CM X 1.8CM (±0.3CM)





DL-8048

單面鏤空雕花尺寸：長 X 寬 X 厚
80CM X 80CM X 3CM (±0.5CM)
樹種：榆木 仿柚木色，霧面平光漆

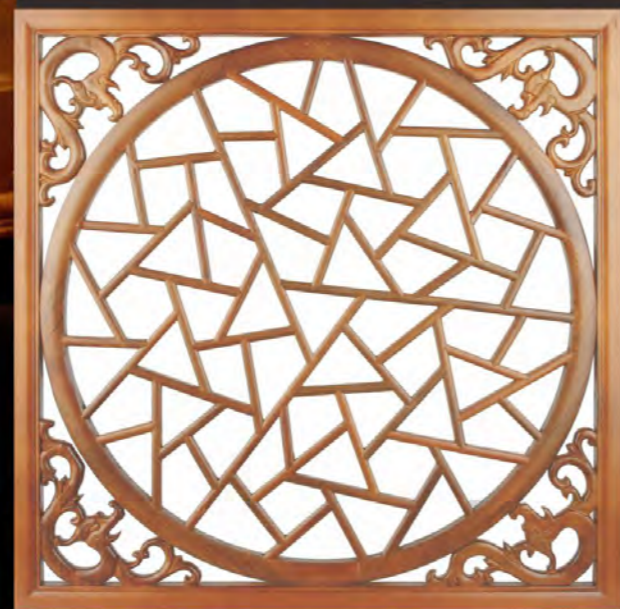

DL-8049

單面鏤空雕花尺寸：長 X 寬 X 厚
75CM X 75CM X 3CM (±0.5CM)
樹種：榆木 仿柚木色，霧面平光漆
內線條尺寸：面寬 X 面高
1.2CM X 1.8CM (±0.3CM)

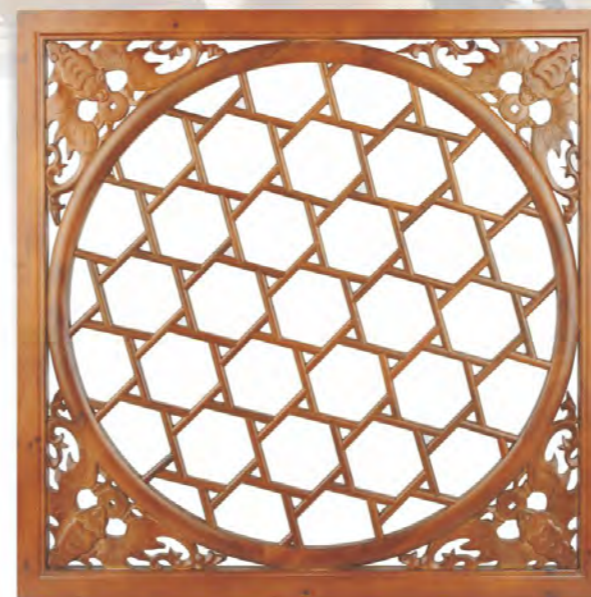
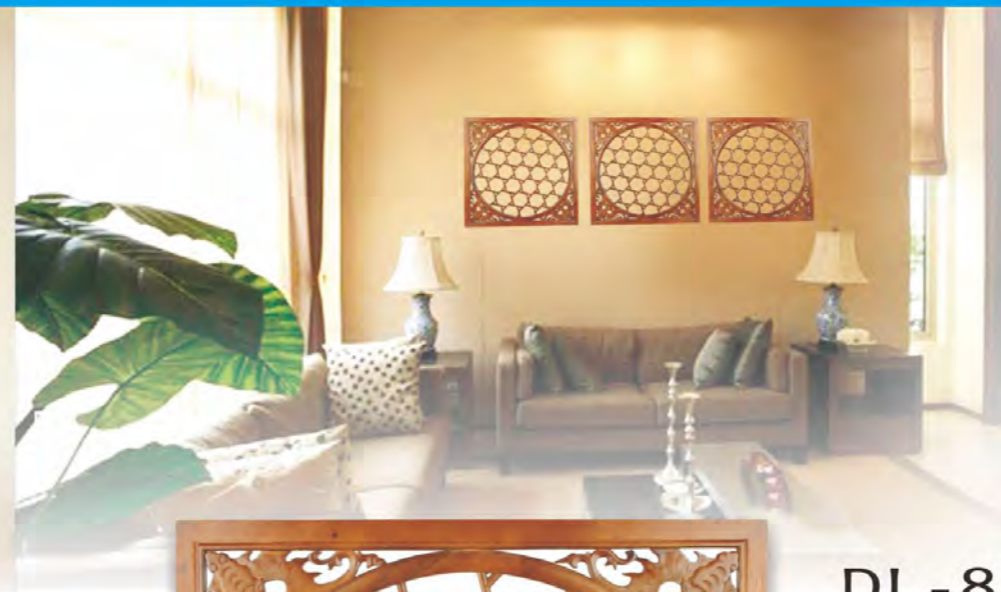

DL-8050

單面鏤空雕花尺寸：長 X 寬 X 厚
68CM X 68CM X 2.8CM (±0.5CM)
樹種：榆木 仿柚木色，霧面平光漆



DL-8051

單面鏤空雕花尺寸：長 X 寬 X 厚
112CM X 87CM X 3CM (±0.5CM)
樹種：榆木 仿柚木色，霧面平光漆
內線條尺寸：面寬 X 面高
1CM X 1.7CM (±0.3CM)





DL-8052

單面鏤空雕花尺寸：長 X 寬 X 厚
75CM X 75CM X 3CM (±0.5CM)
樹種：榆木 仿柚木色，霧面平光漆
內線條尺寸：面寬 X 面高
1CM X 1.5CM (±0.3CM)



DL-8150

單面鏤空雕花尺寸：長 X 寬 X 厚
78CM X 78CM X 3CM (±0.5CM)
樹種：榆木 仿柚木色，霧面平光漆



DL-8154

單面鏤空雕花尺寸：長 X 寬 X 厚
106CM X 55CM X 3CM (±0.5CM)
樹種：榆木 仿柚木色，霧面平光漆



DL-8155

單面鏤空雕花尺寸：長 X 寬 X 厚
122CM X 54CM X 3CM (±0.5CM)
樹種：榆木 仿柚木色，霧面平光漆

DL-8157

單面鏤空雕花尺寸：長X寬X厚
105CM X 93CM X 3CM (±0.5CM)
樹種：榆木 仿柚木色，霧面平光漆



DL-8161

單面鏤空雕花尺寸：長X寬X厚
87CM X 31CM X 3CM (±0.5CM)
樹種：榆木 仿柚木色，霧面平光漆



DL-8158

單面鏤空雕花尺寸：長X寬X厚
106CM X 43CM X 3CM (±0.5CM)
樹種：榆木 仿柚木色，霧面平光漆



燕嘴榫



A 雕刻花板



B 雕刻花板



DL-8163

- 雙面鏤空雕花窗花
- 尺寸：長X寬X厚
217X75.5X3.6CM±0.5CM
- 內線條尺寸：15X18mm
- 時尚簡約—燕嘴榫
- 接受任合尺寸訂做 (不含油漆)
- 樹種
 - A 天然樹種
1.松木 2.美檜 3.越檜 4.柚木
 - B 人造樹種
1.人造柚木 2.人造胡桃 3.人造白橡





燕嘴榫

客製化
窗花

A 雕刻花板



B 雕刻花板



DL-8164

- 雙面鏤空雕花窗花
- 尺寸：長X寬X厚
212X43X3.6CM±0.5CM
- 內線條尺寸：12X18mm
- 時尚簡約—燕嘴榫
- 接受任合尺寸訂做 (不含油漆)
- 樹種
 - A 天然樹種
1.松木 2.美檜 3.越檜 4.柚木
 - B 人造樹種
1.人造柚木 2.人造胡桃 3.人造白橡



燕嘴榫

客製化
窗花

A 雕刻花板



B 雕刻花板



DL-8165

- 雙面鏤空雕花窗花
- 尺寸：長X寬X厚
208X43X3.6CM±0.5CM
- 內線條尺寸：15X18mm
- 時尚簡約—燕嘴榫
- 接受任合尺寸訂做 (不含油漆)
- 樹種
 - A 天然樹種
1.松木 2.美檜 3.越檜 4.柚木
 - B 人造樹種
1.人造柚木 2.人造胡桃 3.人造白橡



客製化窗花

美檜原色

美檜原色

美檜原色

人造柚木

客製化窗花

- 樹種
- A 天然樹種
- 1. 松木 2. 美檜 3. 越檜 4. 柚木
- B 人造樹種
- 1. 人造柚木 2. 人造胡桃 3. 人造白橡



DL-8120

- 雙面窗花
- 尺寸：長X寬X厚 220X50X3.6CM±0.5CM
- 內線條尺寸：15X18mm
- 時尚簡約—四方榫
- 接受任合尺寸訂做 (不含油漆)



DL-8121

- 雙面窗花
- 尺寸：長X寬X厚 210X62X3.6CM±0.5CM
- 內線條尺寸：15X18mm
- 古藝技法—燕嘴榫
- 時尚簡約—四方榫
- 接受任合尺寸訂做 (不含油漆)



DL-8122

- 雙面窗花
- 尺寸：長X寬X厚 240X60X3.6CM±0.5CM
- 內線條尺寸：15X18mm
- 古藝技法—燕嘴榫
- 時尚簡約—四方榫
- 接受任合尺寸訂做 (不含油漆)

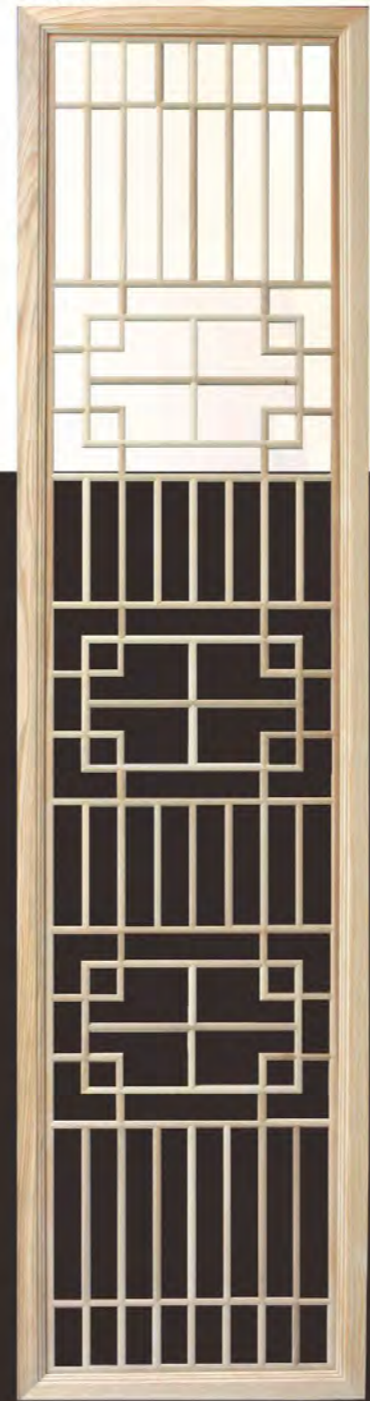

- 樹種
- A 天然樹種
- 1. 松木 2. 美檜 3. 越檜 4. 柚木
- B 人造樹種
- 1. 人造柚木 2. 人造胡桃 3. 人造白橡

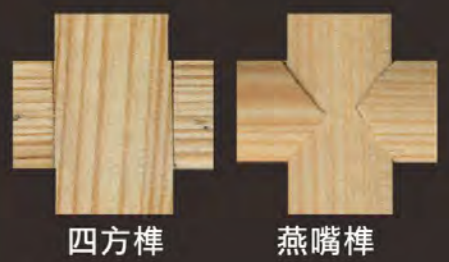

DL-8123

- 雙面窗花
- 尺寸：長X寬X厚 240X60X3.6CM±0.5CM
- 內線條尺寸：15X18mm
- 時尚簡約—四方榫
- 接受任合尺寸訂做 (不含油漆)

