



# GLOBAL FURNITURE ALLIANCE

---

## RISER RECLINER USER MANUAL



# *Contents*

INTRODUCTION	3
PRODUCT INFORMATION	4
BEFORE ASSEMBLY	5
SAFETY	6
ASSEMBLY INSTRUCTIONS	7
HANDSET	10
HEAT & MASSAGE	13
PRODUCT CARE	14
TROUBLESHOOTING	16
WARRANTY	17



# *Introduction*

## S A F E T Y

The product you have purchased combines state-of-the-art components with safety, comfort and styling in mind. Please read and follow all instructions, warnings and notes in this manual and all other accompanying literature before attempting to operate this product for the first time.

If there is any information in this manual which you do not understand, or if you require additional assistance for setup or operation, please contact your authorised retailer.

**Failure to follow the instructions, warnings and notes in this manual and those located on your product can result in personal injury or product damage and will void the product warranty.**

**NOTE:** If you ever lose or misplace your copy of this manual, please contact us and we will be glad to send you a new one immediately.

## P U R C H A S E R ' S   A G R E E M E N T

By accepting delivery of this product, you agree that you will not change, alter, or modify this product or remove, render inoperable or unsafe any guards, shields, or other safety features of this product; or that you will fail, refuse, or neglect to install any retrofit kits from time to time to enhance or preserve the safe use of this product.

## W H E N   Y O U   R E C E I V E   Y O U R   C H A I R

Before using your riser recliner chair, make sure your delivery is complete as some components may be individually packaged. If you do not receive a complete delivery, please contact your authorised provider immediately. Where damage has occurred during transport, either to the packaging or contents, please contact your GFA retailer.

**This manual is generic and incorporates all functionality available across the GFA riser recliner range. Not all functions are available on all models. Please contact your authorised GFA retailer to determine the model you have purchased and the functions specific to that model.**

## Product Information



Please retain this manual for future reference, read and follow the information in the owner's manual



**Tools**  
We do not recommend the use of power tools in the assembly of this product



**Assembly**  
Requires 2 person



**Assembly difficulty**  
Easy



**Estimated time to construct**  
Less than 30 minutes



**Distance from wall**  
0.80m



**Maximum weight capacity**  
125kg (See chair specification as provided by your authorised GFA provider)



Occasional and domestic furniture and not Crib 5. Not suitable for use other than domestic. Maintain and store in a clean and dry environment. 2134 hrs p/a recommended domestic use



**Pinch/crush points hazard!**  
Do not place objects or appendages in the path of moving parts



Do not place objects under the lift chair. Make sure area is clear of obstructions including pets and children during operation



Green LED light indicates that the power is on  
Not available on all models



We recommend that you do not connect an extension cord to the AC/DC converter or the battery charger (if applicable)



if you choose to dispose of your furniture please ensure you properly dispose of all electronic components, including the external transformer, handset, actuator motor and wiring. Contact your authorised GFA retailer for more information.

## Before Assembly



Keep this instruction manual for future reference



It is important to only use this product on a firm, level surface



Keep all small parts out of reach of children and animals



Make sure you have all the components, fixtures and fittings as listed in this instruction manual



Remove all packaging and place the components on top of the empty box or on a clean floor to prevent them from becoming scratched



Make sure you have the right tools and a clean, dry and spacious area for assembly. Assemble on a flat/firm surface to avoid damage



Assemble in the room you intend to use the chair in or as close as possible to that room



Carefully follow each assembly step in the correct order to prevent incorrect assembly



Before use, ensure that the product is fully assembled and only then should the screws and bolts be fully tightened but not over tightened



Do not discard any packaging until the product is fully assembled. This will avoid disposing of any parts



GFA do not recommend the use of power tools to construct this product



Do not use or attempt to assemble this product if parts are missing, damaged or worn

# Safety

**Please read and follow these safety guidelines to get the very best use from your chair. Please note failure to follow these guidelines could result in injury or damage and invalidate the warranty. Always use this chair in accordance with this manual.**

Situate the chair on a flat/level surface.

Ensure that just **one person** uses the chair at a time.

**Do not** leave children or pets unsupervised in or directly around the chair due to potential trapping hazards from the mechanism.

The rise/recline of the footrest is supported by a scissor mechanism; take care to avoid trapping clothing, blankets, fingers etc.

We do not recommend the use of throws or additional loose covers on or near the moving mechanisms.

Plug the power lead directly into an electric socket, **do not use extension cables.**

To avoid over heating **do not cover the transformer.**

The footrest **should not** be used as a seat, it is **not** designed to bear a full weight load.

Please observe the weight limit for the chair. Please refer to the chair specifications as provided by your authorised GFA retailer.

**Do not** 'drop' into the chair, especially if in partially raised position and **do not** stand on the chair or the footrest. **Do not** use this chair as a bed and **do not** sit on the arms.

**Do not** lean or apply downward force to the chair-back while in recline position and **do not** attempt to exit the chair while in the recline position.

**Do not** allow children to play on this mechanised furniture or operate the mechanism. Leg rest folds down on closing and a child could possibly be injured. Always leave in an upright and closed position. Keep hands and feet clear of the mechanism. Only the occupant should operate it.

Ensure the chair is placed at a suitable distance from walls and other objects/furniture to allow full operation of the chair without causing collision or damage.

Check on a regular basis that any bolts, screws or knobs are fixed securely.

Visually inspect the handset, wiring and transformer of the chair for signs of wear on a regular basis.

Avoid ingress of food or drink spillages to the electrical parts.

To move the chair, lift, do not drag as this may cause damage to lifting mechanism and entrap cables.

Use a **minimum** of 2 abled people to move (ensure the chair is disconnected from the main supply).

Only move the chair while in the closed/rest position and **do not** move the chair while occupied. If the chair has been moved, check the wires are clear of the mechanism before use.

Although this chair conforms to the UK fire retardant legal specifications, caution should still be taken to avoid fire. **Take care** from electric, gas or open fires near to the chair and ensure cigarettes and matches are properly extinguished.

**Take care** to avoid sharp objects coming into contact with the chair such as buckles, metal fasteners, needles/pins, scissors etc.

## **For Chairs with Massage or Heat and Massage Function**

Visually inspect the handset, wiring and transformer of the chair for signs of wear on a regular basis.

Avoid ingress of food or drink spillages to the electrical parts.

If the chair has been moved check the wires are clear of the chair base or other furniture before use.

**If there is any information in this manual which you do not understand, or if you require additional assistance for setup or operation, please contact your authorised GFA retailer.**

# Assembly Instructions

## Lift Mechanism

Responds to the hand control commands to position the chair

## Handset

Needed to operate the various functions of the lift chair

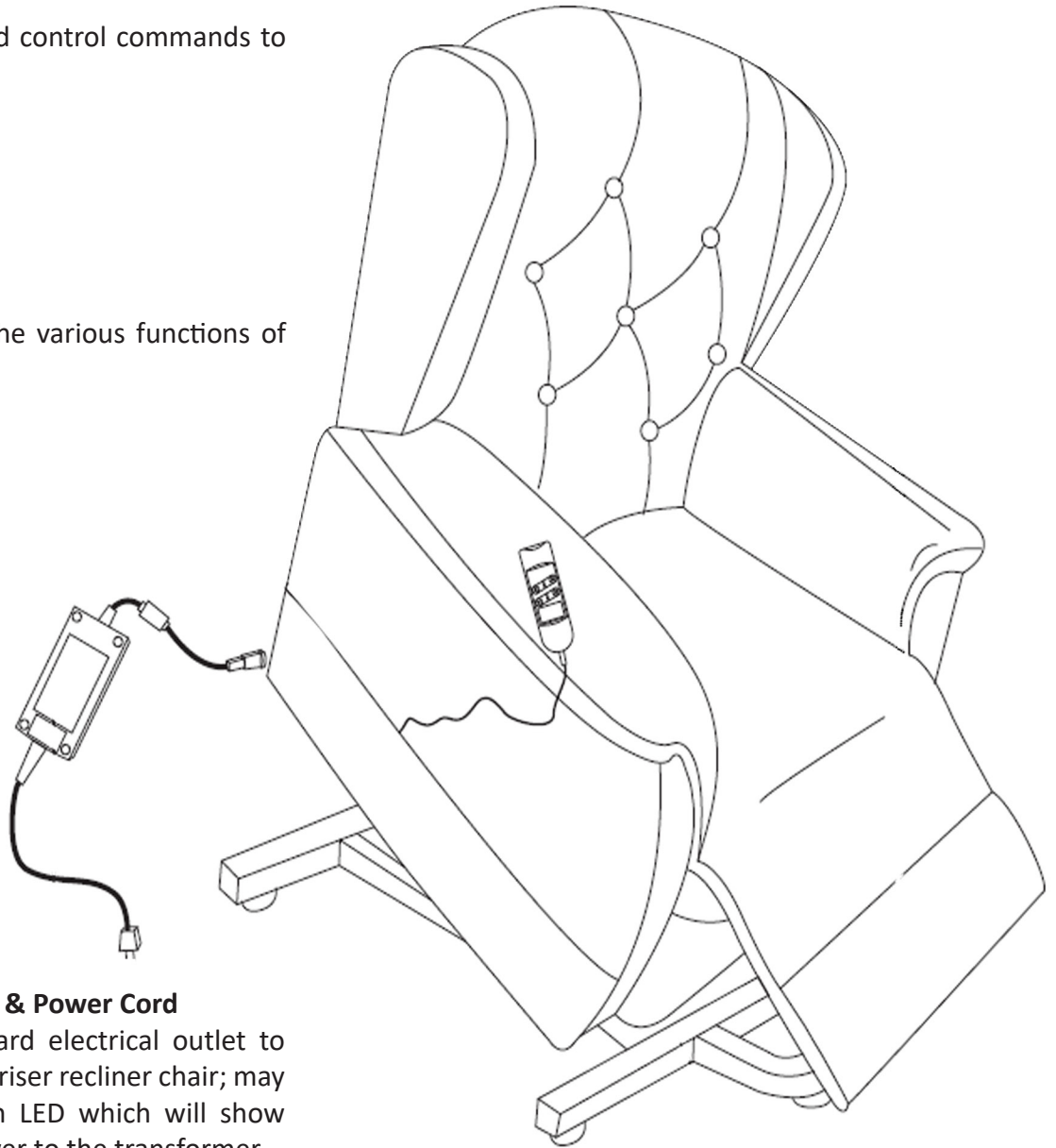

## External Transformer & Power Cord

Connects to a standard electrical outlet to provide power to the riser recliner chair; may be equipped with an LED which will show green to indicate power to the transformer

## Footrest Extension

Provides extension and folds up neatly when lift chair is in the upright or lift positions

# Assembly Instructions

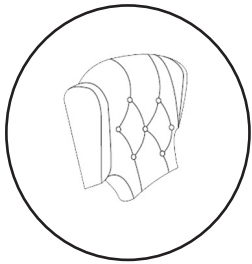

1 x Backrest

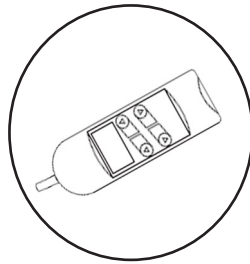

1 x Handset

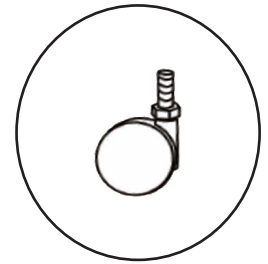

4 x Castors

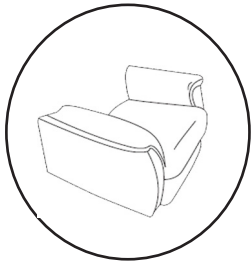

1 x Seat

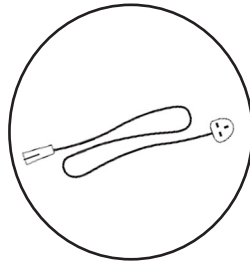

1 x Mains Plug

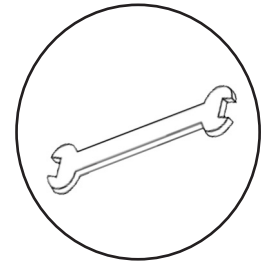

1 x Tool

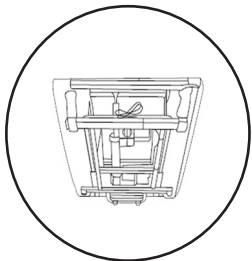

1 x Mech &  
Motor

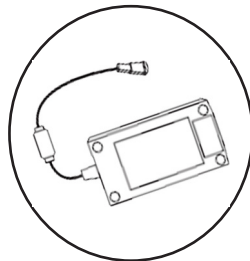

1 x Transformer

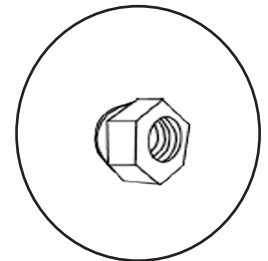

4 x Nuts

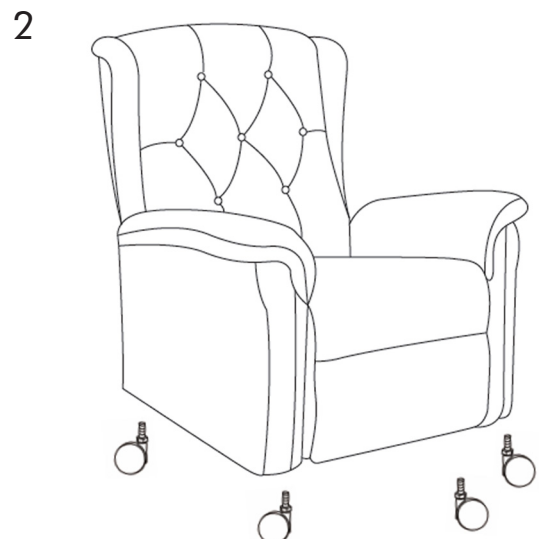
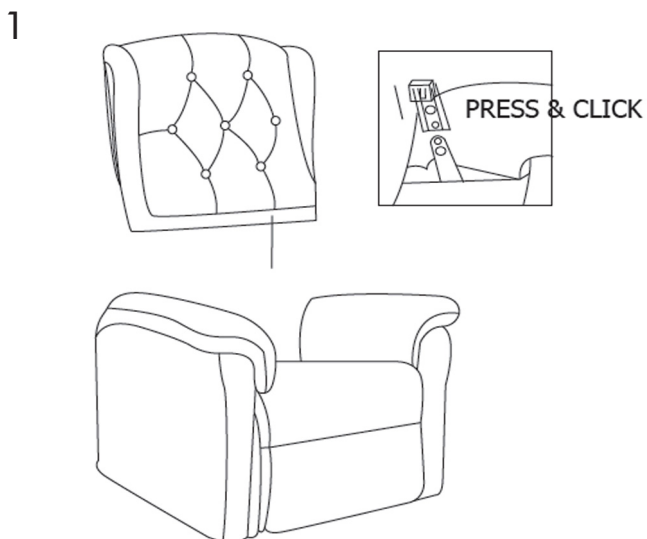



# Assembly Instructions

3

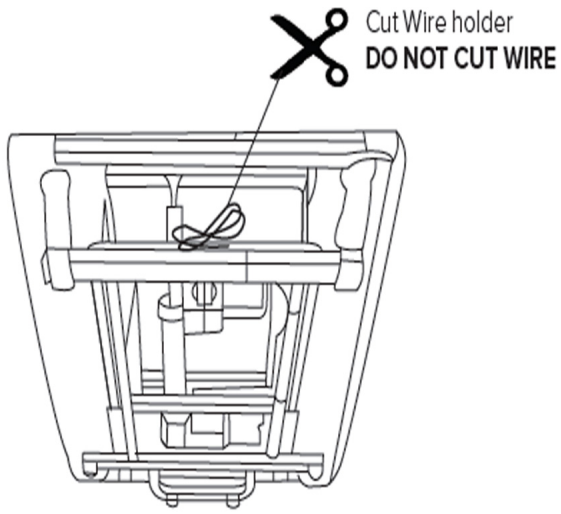

4

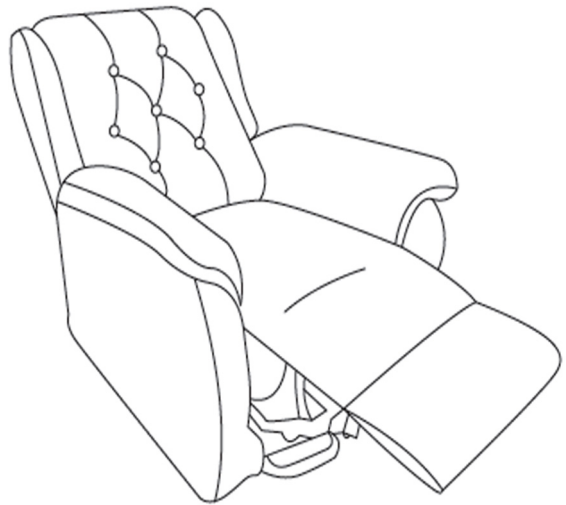

5

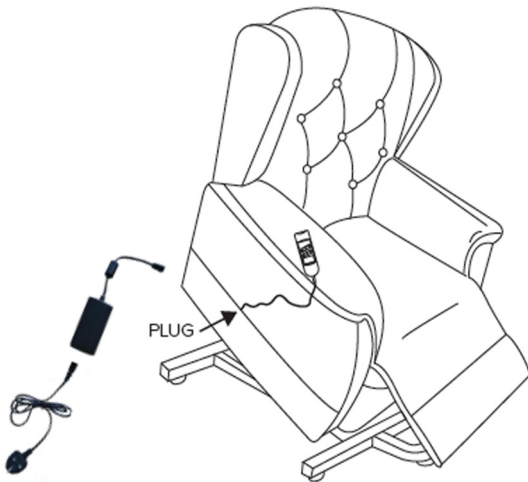

6

**Single Motor Chair**



**Dual Motor Chair**



# Handset

This guide offers basic information on the hand control component and its function. Read this manual thoroughly before operating the chair.

The illustrations used reflect hand controls with the highest level of functionality. The hand control you receive may have fewer options, but basic functionality is the same.

The hand control on your lift chair may be equipped with an LED light that indicates power to the hand control. If this LED is present and not lit when the hand control is in use, please contact your retailer.

Exposing the rubber to heat could melt it or make it sticky.

Note: if your handset has a USB port, you can use it to charge your mobile or tablet device.

## S I N G L E   M O T O R   C H A I R   O P E R A T I O N

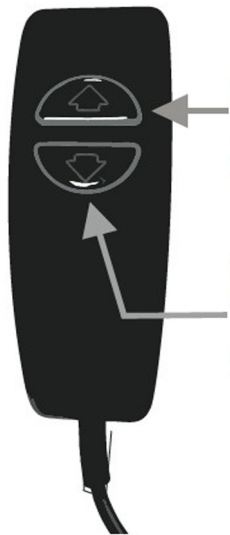

**Button 1.**

Press this button to raise the back rest, lower the leg rest and raise the chair

**Button 2.**

Press this button to lower the chair, recline the back rest and raise the foot rest

## DUAL MOTOR CHAIR OPERATION

**Button 1.**

Press this button to lower the foot rest and raise the chair

**Button 2.**

Press this button to lower the chair and elevate the foot rest

**Button 5.**

Returns chair to normal seating position and then lifts to the upright risen position. If the chair is in a normal seated position this will lift the user to the upright position

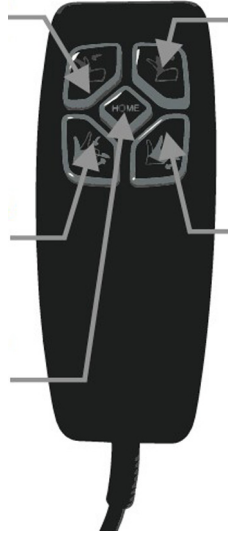

**Button 3.**

Press this button to raise the back rest

**Button 4.**

Press this button to recline the back rest

## TRIPLE MOTOR CHAIR OPERATION

**Button 1.**

Press this button to raise the head rest

**Button 2.**

Press this button to raise the back rest

**Button 3.**

Press this button to lower the chair and elevate the foot rest

**Home.**

Press this button to return the chair to normal seating position and then lift to upright risen position. If the chair is in a normal seated position this will lift the user to the upright position



**Button 4.**

Press this button to lower the head rest

**Button 5.**

Press this button to recline the back rest

**Button 4.**

Press this button to lower the foot rest and raise the chair

# Handset

1. UP BUTTON: Press and hold to raise lift chair to inclined, seated or standing position
2. DOWN BUTTON: Press and hold to lower lift chair to seated or reclined position
3. INCLINE BUTTON: Press and hold to raise the seat back
4. RECLINE BUTTON: Press and hold to recline the seat back
5. RESET BUTTON: Return the chair from every position to a normal seat position

**NOTE:**

Prolonged and repeated use of buttons across short periods of time could affect the longevity of the button function

Only press one button at a time for handsets 1, 2, 5 and 6

For handsets 3 and 4 - pressing and holding the middle of the top 2 buttons while the chair is reclined will bring up the seat back, close the footrest and raise the chair.

While in the raised position, holding down the bottom middle 2 buttons will lower the chair, recline the back rest and raise the foot rest

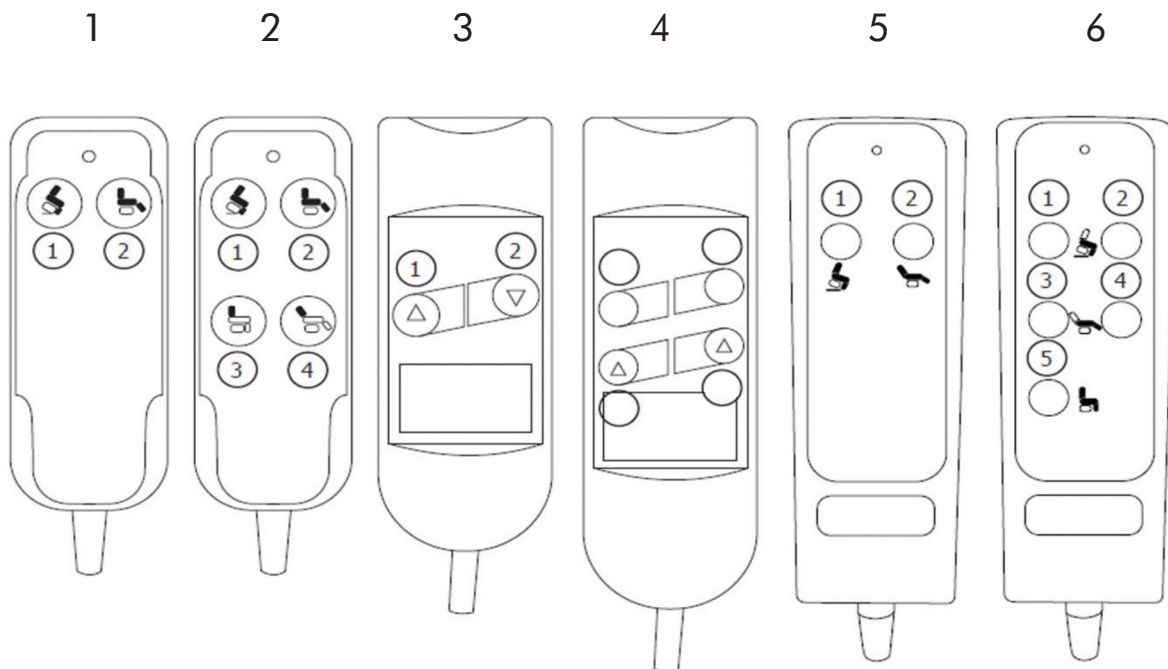

# Heat and Massage

1. ON/OFF: Activates massage system. To turn on, press ON/OFF, to turn off, press ON/OFF again.

The massage system can be timed: press the ON/OFF button until the system starts and it will shut off after 15 minutes, or press TIMER (based on model) to choose the time range you require.

2. HEAT: Activates the heat element/ Press HEAT until the red light appears. Works with the massage or independently and incorporates up to 30 minute time limit (based on model). To continue after the timer shuts off, simply press the HEAT button again.

3. ZONE: Red light indicates the active zone:

- Shoulders
- Back
- Seat
- Legs

4. MODE: Green light indicates active mode.

5. INTENSITY: Controls intensity during all modes - press INTENSITY to increase and decrease.

**NOTE: Not all functionality is available on all models**

## WARNING

Never leave the chair unattended with the power on.

Should the heating become uncomfortably hot, even when on the LOW setting, switch off the mechanism, unplug the mains and contact your authorised GFA retailer for further assistance.

Only use for a maximum of 2 continuous cycles or 30 minutes at a time. Allow the mechanism to rest for a minimum of 15 minutes between maximum cycle period.

Should the vibration not stop when the control is activated, or malfunction in any way switch off at the mains and contact your authorised GFA retailer

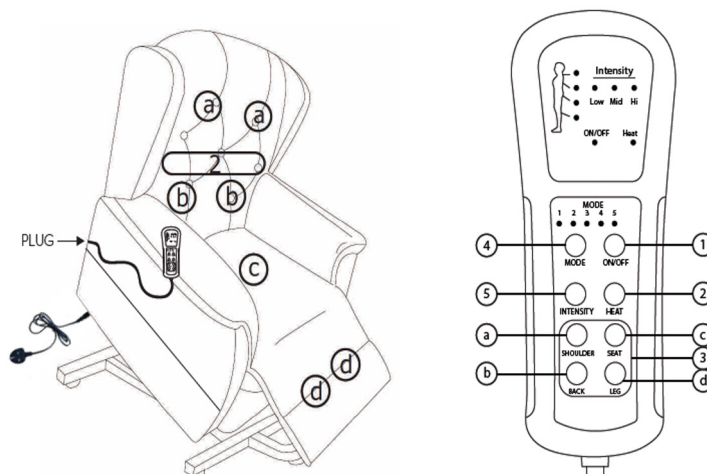

## Product Care

Your lift chair will require routine maintenance checks. You can perform some of these checks, but others may require assistance from an authorised GFA retailer. By following the instructions in this section as suggested, you can help ensure your lift chair gives you years of trouble free operation.

### CARE GUIDANCE FOR LEATHER, BONDED LEATHER OR FAUX LEATHER

Leather is a natural product; therefore it needs reasonable care during normal usage. Do not over expose the leather to sunlight, radiators or close to any heat source. We recommend frequent dusting to eliminate clogging of pores.

### FOR SPOTS AND SPILLS

Blot excess liquid immediately with a clean absorbent cloth or sponge, if necessary, use clear, lukewarm water and gently wipe the spill. Dry with a clean towel and allow to air dry. Do not dry wet areas with hair dryers etc.

#### **For stubborn spots and stains**

For most leather or bonded leather furniture, use a mild solution, such as Neutrogena or Ivory liquid soap, with lukewarm water on a gentle cloth or sponge.

Always clean a small hidden sample area first and always clean gently (no firm pressure).

After cleaning, rinse and dry naturally.

For natural leather, blot excess liquid immediately with a clean absorbent cloth. Stains should disappear eventually.

The leather will initially repel most liquids but, if left to stand over an extended period of time, liquid will be absorbed. That is why it is a good idea to mop up spills immediately. But event the spill is adsorbed, it should dissipate in time.

#### **WARNING**

Saddle soaps, oils, abrasive cleaners, soaps, furniture polish, varnish or ammonia water should not be used on leather. The Leather has already been permanently preserved in the tanning process and needs no maintenance other than the simple cleaning recommended.

**N.B** Please be aware that certain household chemicals and personal care products can have an adverse effect on the leather. This includes the products listed above and also hair preparations, some skincare preparations, rooms sprays ect., plus some strong medications.

### CARE GUIDANCE FOR FABRIC UPHOLSTERY

In all cases remove excess spillage as quickly as possible using a clean white absorbent cloth or paper roll. Blot the stained area so that the fabric is ad dry as possible.

Always use a dabbing rather than rubbing action. Rubbing can abrade the fabric surface of your Upholstery and cause roughened or pulled patches.

Allow the fabric to dry naturally.

## Product Care

In all cases remove excess spillage as quickly as possible using a clean white absorbent cloth or paper roll. Blot the stained area so that the fabric is as dry as possible. Always use a dabbing rather than rubbing action. Rubbing can abrade the fabric surface of your upholstery and cause roughened or pulled patches. Allow the fabric to dry naturally.

This information is provided as guidance only and for any major spill or stain we would recommend professional cleaning.

### **WARNING**

Covers should not be allowed to come in direct contact with any type of heat source, e.g, a space heater, cigarette or candle as personal injury or fire damage may occur.

### **WARNING**

The lift chair has passed legal flammability testing requirements - The Furniture and Furnishings (Fire) (Safety) Regulations 1988 (amended 1989 and 1993) and meets UK specified ignitions resistance levels. Certificates can be obtained via the retailer/GFA recognised retailer, however GFA strongly recommend you do not smoke whilst seated in or using your lift chair. You must adhere to the following safety guidelines if you decide to smoke whilst seated in or using your lift chair:

Do not leave lit cigarettes unattended.

Always keep ashtrays at a safe distance from the lift chairs.

Always make sure cigarettes/cigars are completely extinguished before disposal.

## ELECTRONICS CARE

Inspect all wiring to make sure it is not damaged or frayed, if damaged is evident, unplug the lift chair and contact your authorised GFA retailer for service.

Keep all electronics free from moisture and extreme temperatures. This chair is intended for indoor use only.

### **WARNING**

To prevent any electrical shocks. Ensure that any wires leading from the external transformer to the electrical outlet are kept clear of lift chair pinch points and mechanical linkages.

## DISPOSAL AND RECYCLING

Your chair must be disposed of according to applicable local and national statutory regulations. Contact your local waste disposal agency for information on proper disposal of lift chair padding, metal frame components, covers, components and batteries.

### **WARNING**

Plastic bags are a suffocation hazard, dispose of plastic bags properly and do not allow children to play with them.

# Troubleshooting

## **Where do I find the batch number of my lift chair?**

You can find the batch number in two locations - one is on the back of this manual and the second is underneath the footrest of the chair. Please note that the batch numbers must be provide in order for any replacement parts or service to be carried out.

## **Who do I call for customer service?**

Contact your authorised GFA retailer for service enquiries.

## F R E Q U E N T L Y   A S K E D   Q U E S T I O N S

### **What if my lift chair does not operate at all?**

Ensure the external transformer is plugged into a properly wired electrical outlet.

Check the circuit breaker box is connected to the electrical outlet.

Ensure the low voltage connection cable is plugged in properly.

Ensure the handset and motor(s) are plugged in properly.

Ensure the low voltage connection cable is plugged into the motor(s)

Move the UP/DOWN switch on the handset to the UP and DOWN position and listen for a clicking noise from the external transformer. For the Heat and Massage Models, the clicking noise comes from the motor control box under the chair. If there is no clicking noise, then the motor is not receiving power from the handset and the handset may need to be replaced. if you do not hear the clicking noise, the there may be a problem with the motor and to may need t be serviced or replaced. Contact your authorised GFA retailer for further assistance.

### **What if my chair operates in one direction only?**

Check the UP/DOWN switch on the handset to make sire there is a smooth movement from the UP position to the DOWN position. If the switch is sticking in either positions, the handset may need to be replaced.

Move the UP/DOWN switch on the handset to the UP and Down positions and listen for a clicking noise from the external transformer, if there is no noise, the motor many not be receiving power form the handset control and the handset may need to be replaced.

Contact your authorised GFA retailer for further assistance.

### **What if my lift chair stops during a lifting cycle?**

The floor may be uneven or the carpet may be affecting the chair position.

### **What if my chair or handset start to overheat or smell like smoke?**

Unplug the mains, and discontinue use of the chair immediately. Contact your authorised GFA retailer for further assistance.

### **WARNING**

If you are uncertain about your chair and the way it is working, unplug it and contact your authorised GFA retailer for further assistance.



# Warranty

## **Your new chair is covered by a warrant, please note that this does not include:**

- Damage caused by user over the maximum weight limit.
- Damage caused by neglect or improper use (e.g. people sitting on the arms or elevated footrest).
- Fading over time or due to prolonged exposure to sunlight.
- Damage from spills and leaks.
- Cigarette or match burns.
- Damage from collisions with wall or other objects too close to the chair.
- Accidental tears and damage.
- Damage caused by animals (scratches/claw and bites/ teeth).
- Damage caused by non recommended cleaning or maintenance.
- Unauthorised repairs or adaptations.

In the event of issues with your chair, contact your retailer quoting the batch number on the back of this manual.

If you find a fault with any electrical element of the chair, unplug the chair and contact your retailer quoting the model name and batch number on the back of the manual.

The warranty is non transferable.

The manufacturer reserves the right to alter, without notice, any weights, measurements or the technical data presented in this manual

damage caused by not adhering to the safety, product care, assembly instructions shown within this manual, will invalidate the warranty.

This warranty does not affect your statutory rights with the retailer you have purchased the chair from.

GFA BATCH NUMBER



GLOBAL FURNITURE ALLIANCE  
LUXURY IN YOUR LIVING ROOM

T: 01291 645080 | F: 01291 645099  
E: SALES@GFA.UK.COM | W: WWW.GFA.UK.COM