

The New Face of Building Exteriors.



APPALACHIAN ASH



ARIZONA SANDSTONE



BUCKS COUNTY GRAY



GOLDEN MONTANA



ROCKY MOUNTAIN CLAY



INSTALLATION GUIDE



Tando provides these instructions as general guidelines only. The contractor and/or installer shall be responsible for ensuring that all applicable local building codes are followed, which may require modification of these general guidelines. Tando assumes no liability for personal injury or property damage resulting from improper or careless application of the described techniques.

For more information on Tando and its wide variety of state of the art products, please call us at 844-MY-TANDO (844.698.2636).

Installation Guidelines can be downloaded from our website: www.tandobp.com.

GENERAL INFORMATION

1-Tando products are intended for use in a vertical placement only and are not designed or warranted for roofing or flooring applications. However mansard roofs with a 45/12 slope or greater are acceptable applications.

2-Tando products are designed as an exterior cladding, not as a weather resistant barrier. TandoStone is designed to allow the material underneath it to breathe; therefore, it is not a watertight covering. To achieve designed performance, TandoStone must be installed over a weather resistant house barrier system, such as house wrap.

3-As with the majority of exterior building materials, Tando products will expand and contract with a change in temperature. Therefore, during installation it is necessary to position the TandoStone properly to compensate for temperature effects.

4-It is essential to work over a smooth, flat, nailable wall surface, (i.e. minimum 7/16"(1,11cm) OSB board or plywood is recommended). If Tando products are being installed over furring strips, furring strips must be installed on a 45° angle, spaced 8"(20,32cm) center to center, while ensuring that the side seams are supported by furring strips.

5-Fixtures cannot be installed directly onto TandoStone; always use a wooden support or specifically designed mounting blocks to attach fixtures. Follow the mounting block manufacturer's installation instructions and ensure proper clearance to the TandoStone (recommended minimum of 1/4"(0,64cm)) to allow room for expansion and contraction.

6-Non-corrosive fasteners are required to secure the product and they must penetrate through the solid surface by at least 1 1/4"(3,18cm) and into a solid substrate by at least 7/16"(1,11cm).

7-Always begin the installation at the lowest point of the structure, work from left to right installing one row at a time, and completing one wall before beginning another.

8-Store product on edge (vertical), do not stack flat.

9-Keep the R-E-L number, located on the box of your products (ex: REL-123456) for future reference.

10-To cut the material, it is recommended to use a circular saw with a thin kerf finishing blade.

11-Some finish trims such as J-channel and Outside Corner Post, must be installed on wall prior to installation of TandoStone. Follow the finish trim manufacturer's instructions for proper installation.

12-Fastening TandoStone should not restrict movement. Fasteners should be driven straight into the center of any nailing slot with the head of the fastener making light contact with the product, allowing the section to be hung. The center nail hole must always be securely fastened to ensure that the section expands and contracts from the center out.

13-If a partial piece is used at either end, a new center hole should be created, by drilling a 1/8"(0,32cm) hole in the top flange, near the center of the section at the same height as the other installation holes.

14-If face nailing is employed, pre-drill a hole in an inconspicuous area, such as a mortar joint. The hole must be larger than the shank of the nail or screw, but smaller than the head, to allow for possible thermal movement. The head can be covered with matching paint or caulk.

15-It is best to work with the product at waist-level, allowing the installer to inspect the back of the product, verifying that all fingers are properly engaged. Do not force product down onto the flange of the lower row, as this may damage the stop posts and/or will override the expansion joints and cause buckling.

16-Fitting product between windows and around openings requires a spacing of 1/4"(0,64cm) to allow for expansion.

17-Variations in shade and color are an inherent characteristic of TandoStone color.

CREEK LEDGESTONE INSTALLATION GUIDE

BASIC GUIDELINES

1-Always fasten through the center of the nailing slots. Each complete section must be fastened through the center hole, at both extremities and have a minimum of 7 fasteners in the nailing channel at maximum spacing of 8"(20,32cm) or less and one fastener into the lateral hole (Figure 1). Closer spacing of fasteners is required for high velocity wind areas; for details refer to report ESR-3070, which can be downloaded from our website www.tandobp.com. If TandoStone is installed on a wall with furrings, furring strips should be installed on a 45° angle, at 8"(20,32cm) center to center and a furring strip is required behind each fastener.

Figure 1

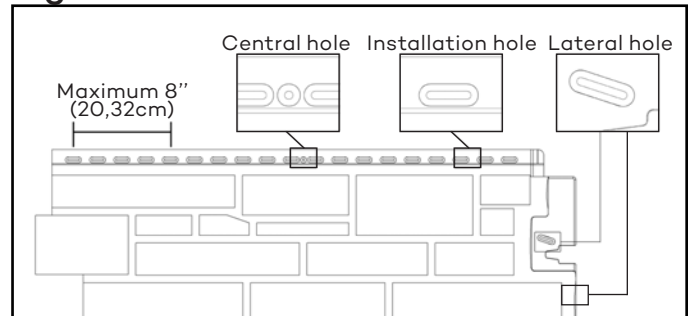

2-Never hammer or screw the fasteners in completely; leave a gap of 1/16"(0,16cm) between the nailing channel and the fastener's head (Figure 2). Always use non-corrosive nails or screws with a head of 0.4"(1cm) in diameter and a body of 0.150"(0,38cm) in diameter and penetrate through the solid surface by at least 1 1/4"(3,18cm) and into a solid substrate by at least 7/16"(1,11cm).

Figure 2

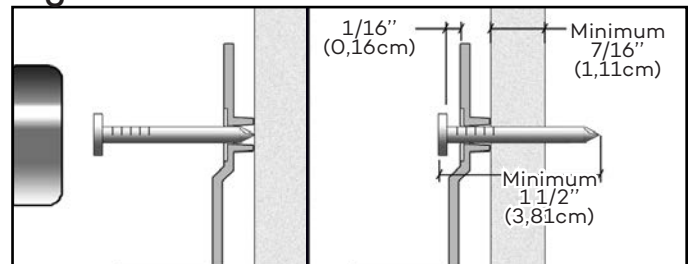

3-Make sure that all pieces are properly joined together (two side locks and 9 hooks at the bottom of the section) (Figure 3).

Figure 3

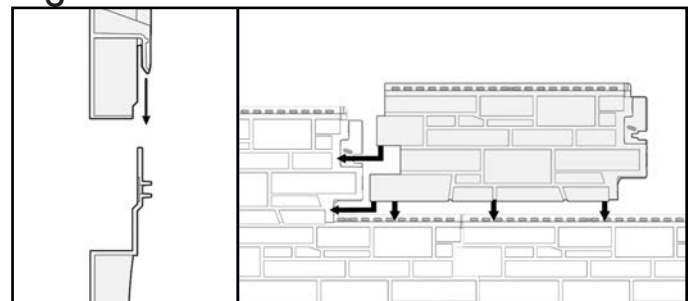

4-When using a finish trim (J-channel, Outside Corner Post, etc.), leave a space of 1/4"(0,64cm) between the trim and TandoStone (Figure 4). The required opening for finish trim is 1 1/8"(2,86cm).

Figure 4

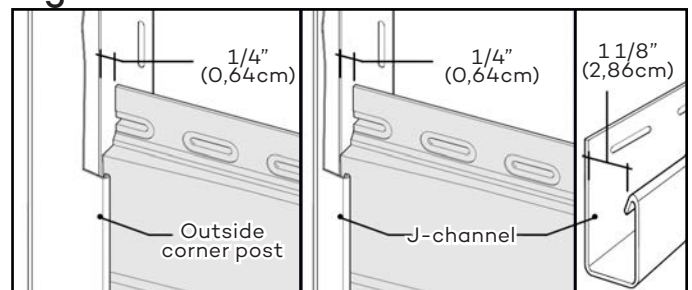

Some elements of the image above were partly removed to facilitate understanding.

CREEK LEDGESTONE INSTALLATION GUIDE

INSTALLATION STEPS

1-First install the starter strips at the lowest point of the structure. Make sure that the horizontal starting line is perfectly leveled and square with the wall. Leave a 3 1/2"(8,89cm) gap at each end of the wall for corner posts, corners or J-channels (1). If a floor is against the wall, install the top of the starter strips at 2 3/8"(6,03cm) above it in order to leave a gap of 1/2"(1,27cm) between starter strips and the floor (2). If there is no floor, starter strips should be flush with the base of the wall. Fasten the starter strips at maximum spacing of 8"(20,32cm) or less. Install the next starter strip by pressing it against the previous (3) and fasten as mentioned above (Figure A). Be sure to align adjacent walls.

2-Determine the number of sections needed for the wall by dividing the total length of the wall, less the width of the corner pieces used, by 40"(101,60cm). Cut the left side of the first section in a straight line in order to avoid having a very small piece at the right end of the wall. Any installed sections should be at least 12"(30,48cm) long. Insert the first section onto the starter strip and slide it leftward leaving a 2 1/2"(6,35cm) space between its edge and the wall corner (Decorative corners will be installed after. See corners installation instruction section for detail.) or slide TandoStone into the trim leaving a space of 1/4"(0,64cm) between the inside wall of the trim and the section (Figure B).

3-On each section, fasten the center hole of the product, this will ensure even movement of sections in both directions during expansion/contraction. Also place a fastener into the last hole on both ends, plus 2 others evenly spaced on each side of the center hole of the nailing channel (Figure C). Fasteners should never be spaced more than 8"(20,32cm). Each full length section should be secured with a minimum of 7 fasteners in the nailing channel and one fastener into the lateral hole. Remember that fasteners must be placed in the center of the nailing slots. Always use non-corrosive fasteners penetrating into a solid substrate of no less than 7/16"(1,11cm) thick. When attaching the fasteners, be sure they only lightly touch the product allowing it to move with varying temperatures and they are installed flush with the section, so as not to interfere with the succeeding row.

- If product is installed on a furring wall, a furring strip is required behind each fastener.
- If a section piece does not have the initial center hole, drill a new center hole of 1/8"(0,32cm) diameter at the same height as the other installation holes.

4-Install the following section by hooking it onto the starter strip and sliding it to the left inserting the side lock into the previous. Space the sections equally according to the outdoor temperature during the installation. If product is installed in an outdoor temperature from 30°F to 100°F (-1°C to 38°C) position the next section so that its upper left edge butts up against the previous section nail hem. For installations below 30°F (-1°C), position the section slightly right of the previous section (1/16"(0,16cm)) (Figure D). Once the section has been properly spaced, fasten it as previously indicated. Repeat this step until the end of the row.

Figure A

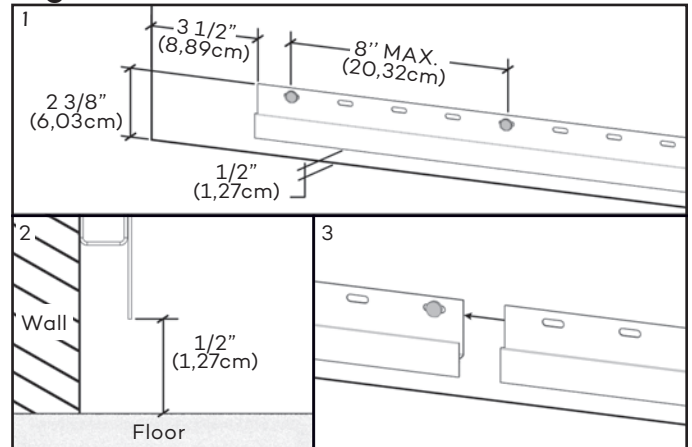

Figure B

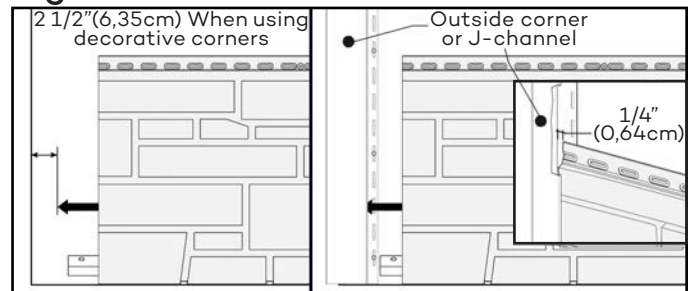

Figure C

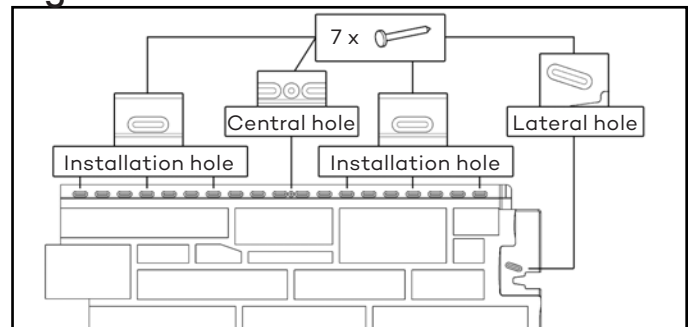
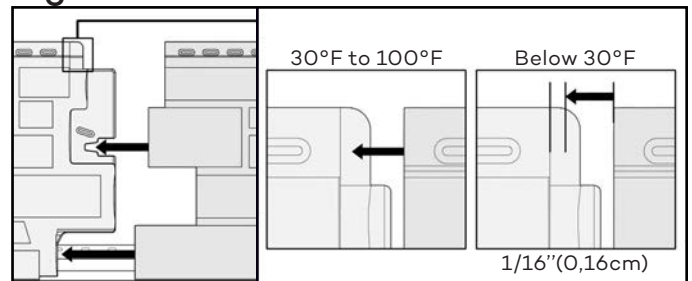

Figure D



CREEK LEDGESTONE INSTALLATION GUIDE

INSTALLATION STEPS (CONTINUATION)

5-Begin the second row by cutting the first section with approximately 8”(20,32cm) increment from the cutting line of the first row. Hooking the section onto the top of previous row. Never force sections down on top of each other or into each other, left to right, or else risk breaking the stop posts on the back of the product. Set them into place gently, ensuring that all fingers and/or side locks are engaged, and allow the sections to seat themselves. The stop posts are designed to prevent buckling due to changing temperatures. In order to achieve a realistic Creek LedgeStone look, alternate the cut position of each subsequent course in increments of 8”(20,32cm) (Figure E).

6-For the last row or places where you may need to attach product other than in installation holes, use a knife to create a new 1”(2,54cm) slot (Figure F); the slot must be wider than the fastener but not as wide as the fastener head. Although not set in installation holes, this type of cutting will allow the expansion/contraction movement of sections.

-Note: For proper installation & optimal appearance, shim as required to adjust the angle of the last row.

Reminder: Do not set accessories directly on the product. The fasteners must be fixed into a solid surface. If you need to set accessories over TandoStone, at a concealed spot on the product, create a new 1”(2,54cm) slot larger than the fastener body but smaller than the fastener head to permit expansion/contraction of sections.

Figure E

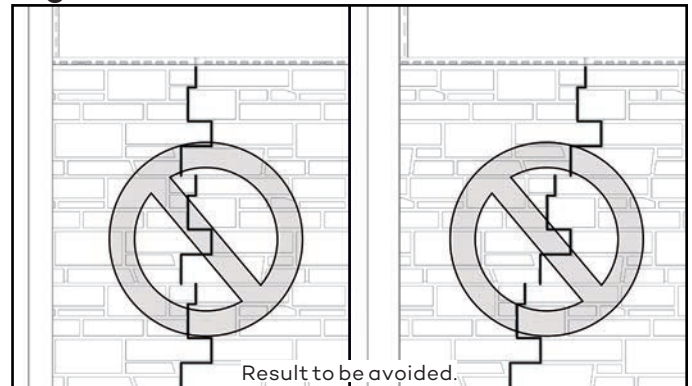
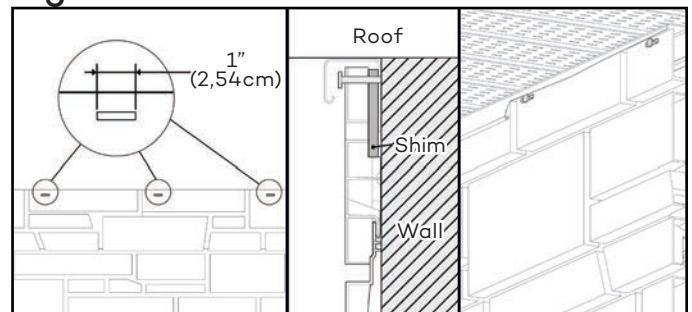

Figure F



Some elements of the image above were partly removed to facilitate understanding.

SPECIAL SITUATIONS AND SUGGESTIONS

SITUATION:	ITEMS TO CHECK:
- Sections won't lock together side to side.	The wall may not be level and flat. Check previous sections to ensure that all sections and installation fingers are properly seated. (See General Information) Use shims as needed to ensure a level wall surface.
- The bottom locking fingers won't lock onto the previous row.	
- Sections are buckling on the wall.	Make sure the fasteners are not restricting product movement. Check for proper spacing at side interlocks. Make sure all fingers are properly engaged into previous section.
- Sections are not laying flat against the wall.	

CREEK LEDGESTONE INSTALLATION GUIDE

DECORATIVE CORNERS INSTALLATION

Caution: Product must be installed on adjacent walls prior to installation of the corners and be sure that rows are aligned.

1-When using the Tando Creek LedgeStone corner, install a starter clip, open end up and 1/8"(0,32cm) above the top of the starter strips. Be sure to leave a 2 1/2"(6,35cm) space between the bottom of the starter clip and the floor (Figure G).

Figure G

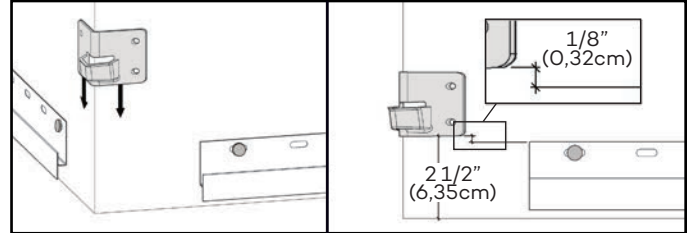

2-Slide the first corner over the product and engage it into the starter clip (#1, Figure H). Once positioned properly, insert one fastener on each side of the nailing head. Galvanized screws are recommended as fasteners.

Figure H

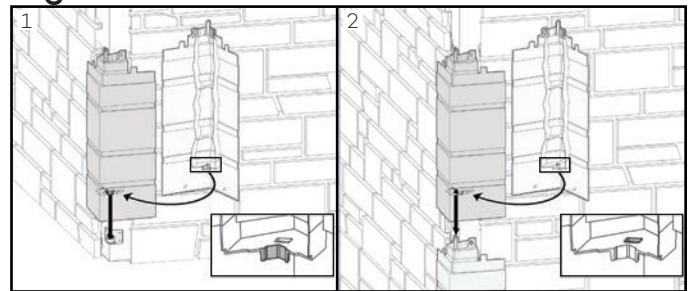

3-Install another corner over the product and engage it into the corner below (#2, Figure H). Some adjustment may need to be made at the vertical overlap of two corners (as they are installed) in order to maintain the corner/section horizontal alignment. There is approximately a 1/2"(1,27cm) vertical adjustment available. Gently tug the bottom of the corner to ensure it is properly engaged and fasten it. Repeat this step until the last corner installation.

4-For the last corner only, cut excess from part. On each side of the corner, make a hole wider than the shaft of the nail, but smaller than the head. Affix a nailing strip behind these locations and install the cut part on wall and fasten it on each side (Figure I).

Figure I

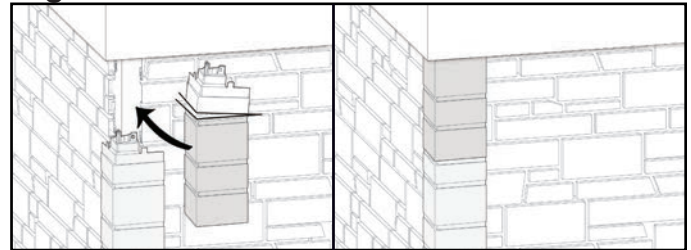

INSTALLATION TIP

1-Many solutions are possible to finish an inside corner: Inside Corner Post (A) or two J-channels (B) (Figure J). It is important to seal the inside corner of the wall prior to installation of the trim.

Figure J

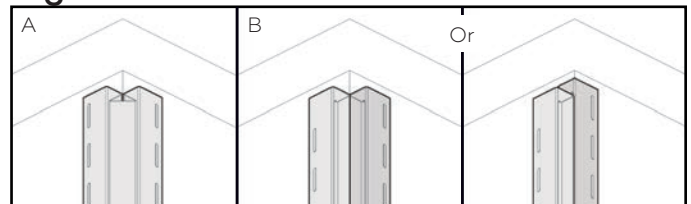

For details, see the respective installation guide of each product.