

MDL System. Michele De Lucchi
Angelo Micheli
Giovanni B. Mercurio

UNIFOR



MDL System

Sistema di tavoli, scrivanie e complementi per gli spazi di lavoro contemporanei. Componenti modulari, leggeri e funzionali, progettati per rispondere alle esigenze di flessibilità di un ambiente condiviso, dove convivono e si alternano situazioni, tra loro, molto diverse. Attività operative, di comunicazione e di relazione. Scrivanie singole complete di attrezzatura, postazioni professionali aggregate in linea o fronteggianti, tavoli per riunioni di varie forme e dimensioni, mensole e cassettiere. Un programma di arredi per ufficio che si qualifica per la leggerezza formale, la flessibilità strutturale e la completezza delle dotazioni.

A complete line of tables, desks and accessories for the contemporary office. Light, functional, modular elements designed to meet the needs of flexibility in a shared space where a variety of activities coexist and alternate. Business activities, communications and conferences. Individual desks complete with accessories, professional workstations grouped side by side or facing each other, conference tables of different types and sizes, shelving and file cabinets. It is a program of office furniture that qualifies itself for its formal lightness, structural flexibility and completeness.

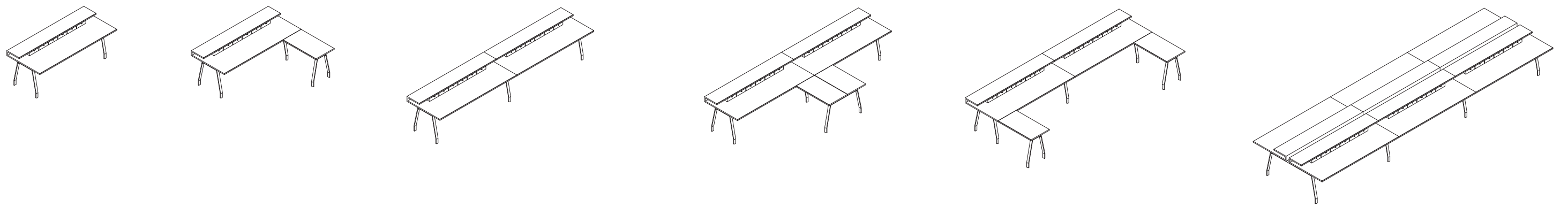

MDL System_Full

Lo spazio operativo è risolto con scrivanie singole o aggregate, attrezzate per contenere tutto il necessario, in modo da rendere ogni postazione autosufficiente e personalizzata su specifiche esigenze funzionali. Accuratamente progettato nei minimi dettagli, il tavolo operativo è caratterizzato dal particolare profilo a C disegnato dal piano di lavoro, che realizza un'originale mensola di servizio fornita di pratici cassetti portaoggetti e predisposta per la connessione alla rete (elettrica, telefonica, dati). La dotazione funzionale è completata da vassoio porta cavi, piano ausiliario e cassettoniera metallica su ruote.

The workspace is equipped with separate or clustered desks, with all the accessories necessary to contain everything needed to make each workstation self-sufficient and personal, with specific functional requisites. Accurately designed down to the last detail, the worktable is characterized by the special C-profile created by its top, that becomes an original service counter equipped with practical drawers to hold everything, and already designed for connection to the mains (power, phone and data). The functional accessories include the cable raceway, auxiliary shelf and metal file cabinet on wheels.



Contraddistinta dall'originale profilo a C, la scrivania integra una pratica mensola di servizio, sotto la quale sono posizionati i cassetti portaoggetti.
 Il piano di lavoro è realizzato in laminato ad alte prestazioni con finitura superficiale opaca e bordo smussato tutto colore. La struttura è costituita da estrusi di alluminio verniciato alle polveri epossidiche. Tutti i componenti sono di colore grigio platino.

Distinguished by the original C-profile, the desk is complete with a practical service shelf that houses convenient drawers. The top is surfaced in high-performance laminate with a matt finish and beveled edges all in the same shade. The structure consists of extruded aluminum painted with epoxy powder. The color of all the elements is platinum gray.

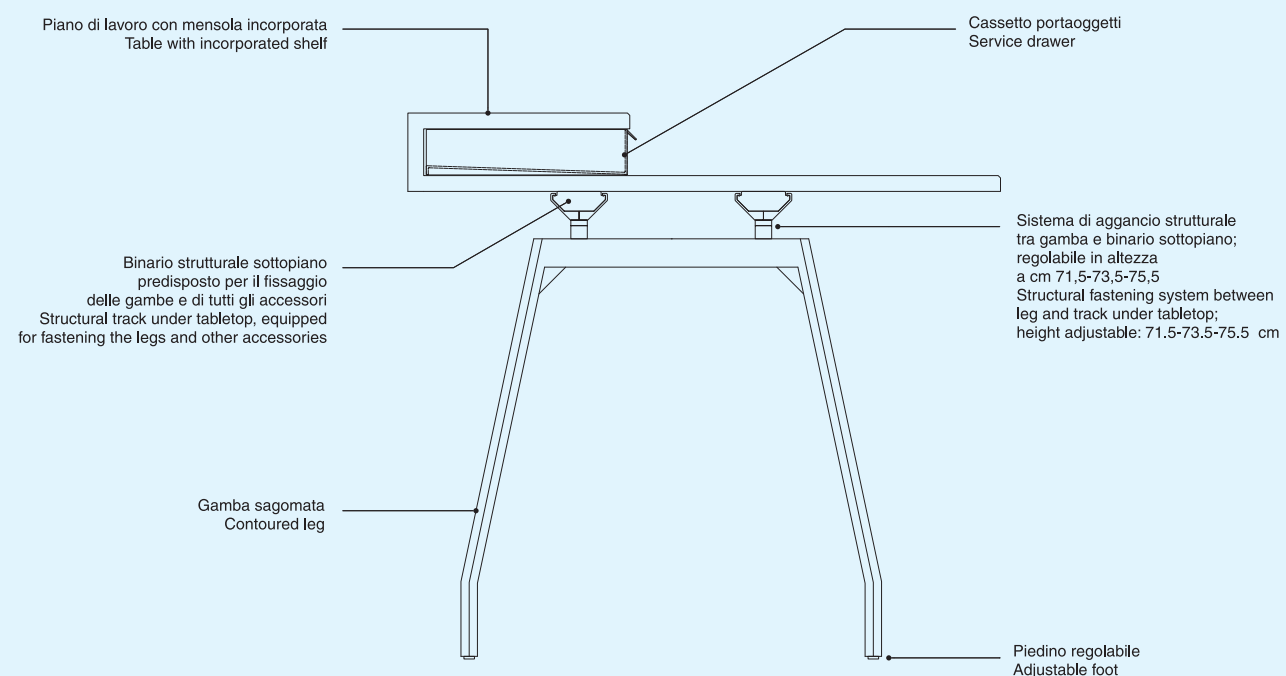
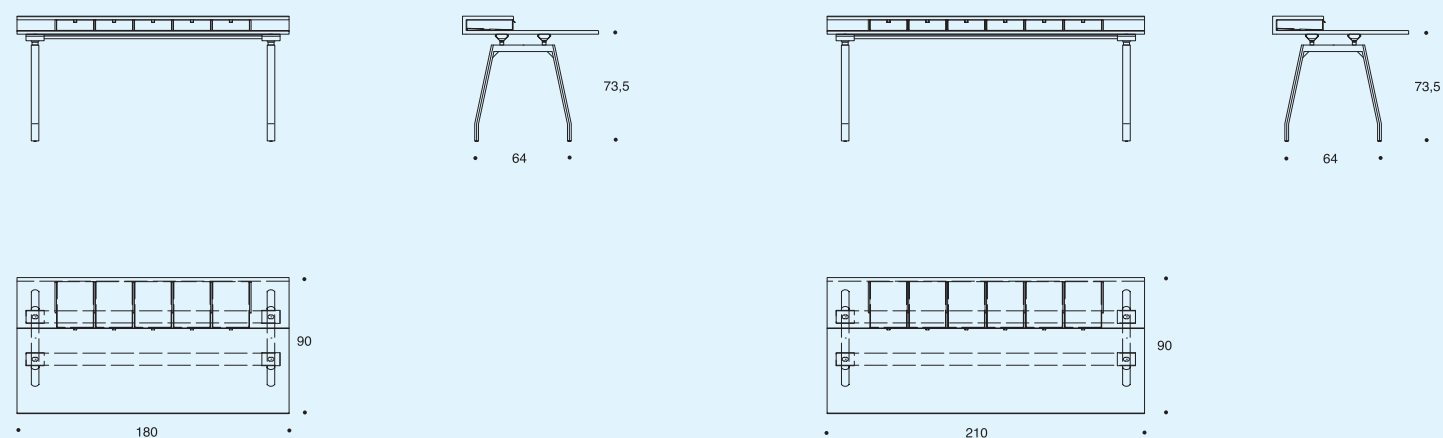



Proposta nell'elegante versione con finiture in legno naturale (ciliegio americano o rovere) e alluminio anodizzato lucido, la postazione operativa autonoma è completata dal piano di lavoro ausiliario.
 La flessibilità del sistema costruttivo consente di posizionare i vari componenti in base a specifiche esigenze di progetto.

Offered in this elegant version with natural wood finish (American cherry or oak) and polished anodized aluminum, the separate workstation is complete with an auxiliary shelf. The flexibility of the construction makes it possible to assemble various elements based on specific project needs.

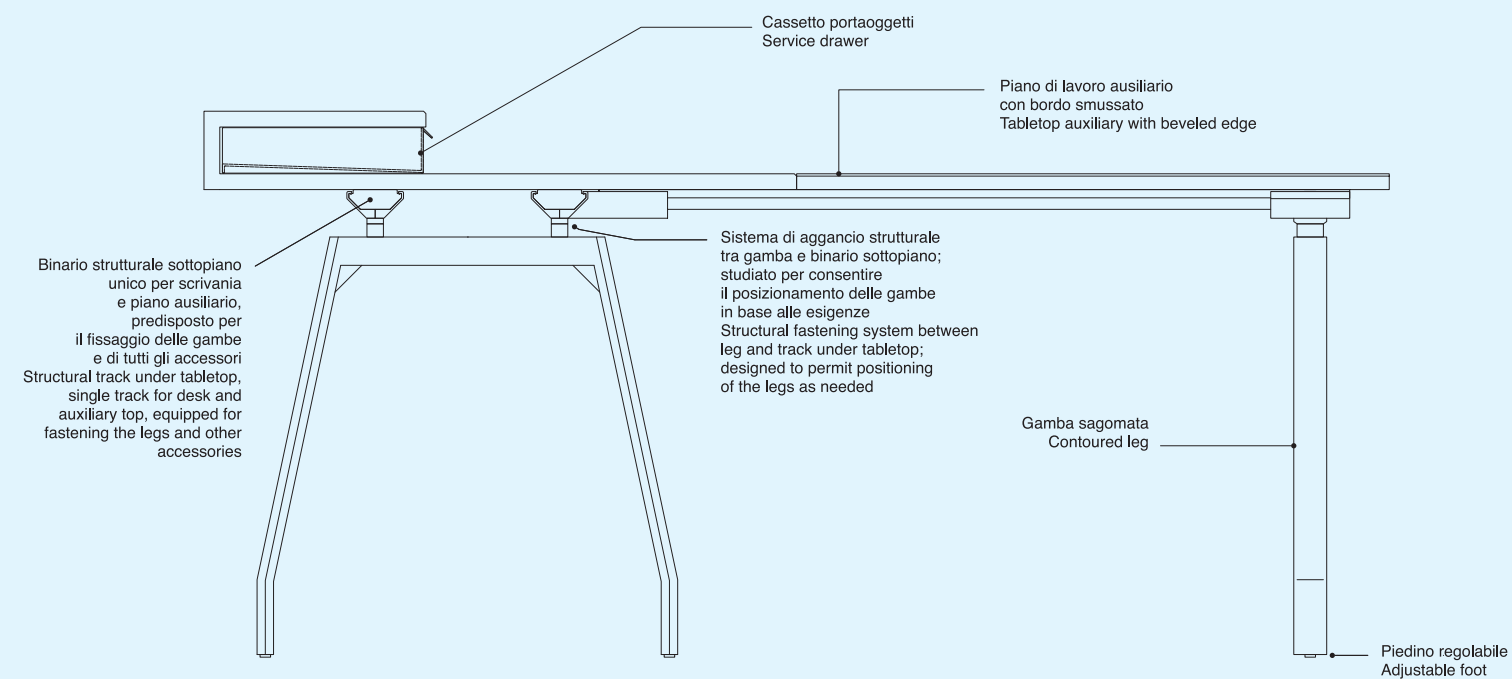
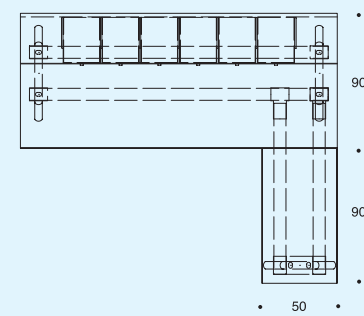
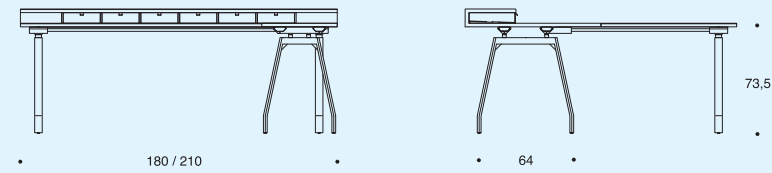

Studiato per facilitare le operazioni di montaggio, il sistema di aggancio strutturale tra gamba e binario sottopiano consente di calibrare la posizione e ogni componente secondo necessità, assicurando comunque adeguate prestazioni tecniche e di sicurezza. Allo stesso modo è possibile regolare il piano di lavoro a tre diverse altezze di utilizzo.

Designed to facilitate the assembly operations, this system of structural fasteners between the leg and the track under the top makes it possible to calibrate the position of every element as needed, always ensuring optimum technical performance and safety. It is also possible to adjust the position of the desktop in the same way, at three different heights.

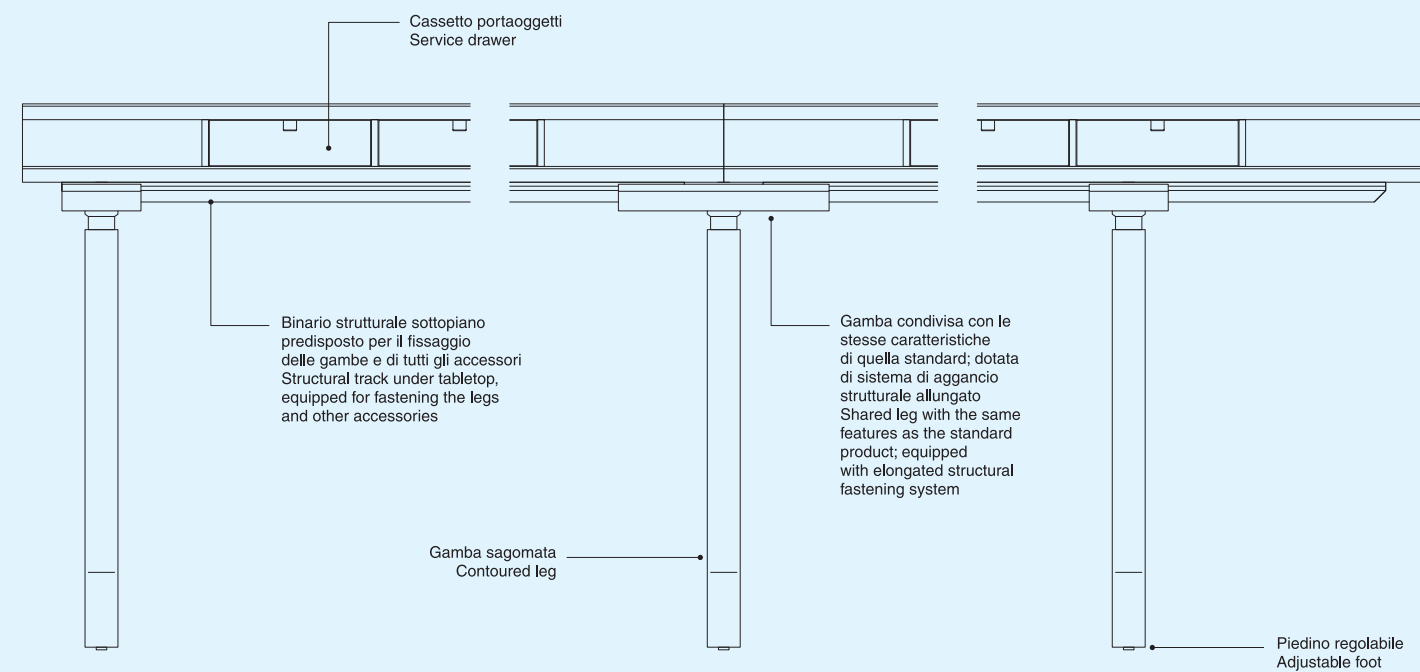
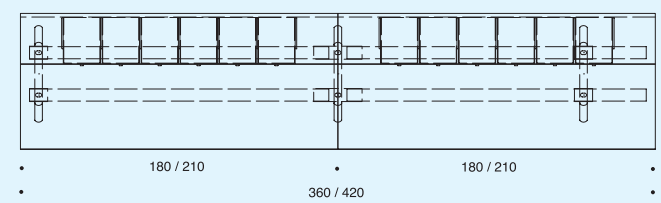
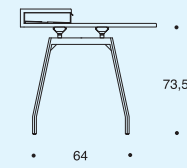
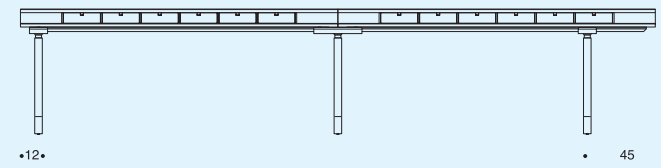

La configurazione con sei postazioni di lavoro aggregate in linea fronteggianti si caratterizza per la semplificazione strutturale: i tavoli contrapposti sono sostenuti da un'unica coppia di gambe sagomate. L'accurato studio dei particolari costruttivi e dei sistemi di assemblaggio, inoltre, qualifica la proposta sul piano della leggerezza formale e dell'efficienza operativa.

The configuration with six workstations clustered in line and facing each other is characterized by its structural simplicity: the facing tables are supported by a single pair of contoured legs. The careful study of the construction parts and methods of assembly also qualify the product in terms of formal lightness and operating efficiency.

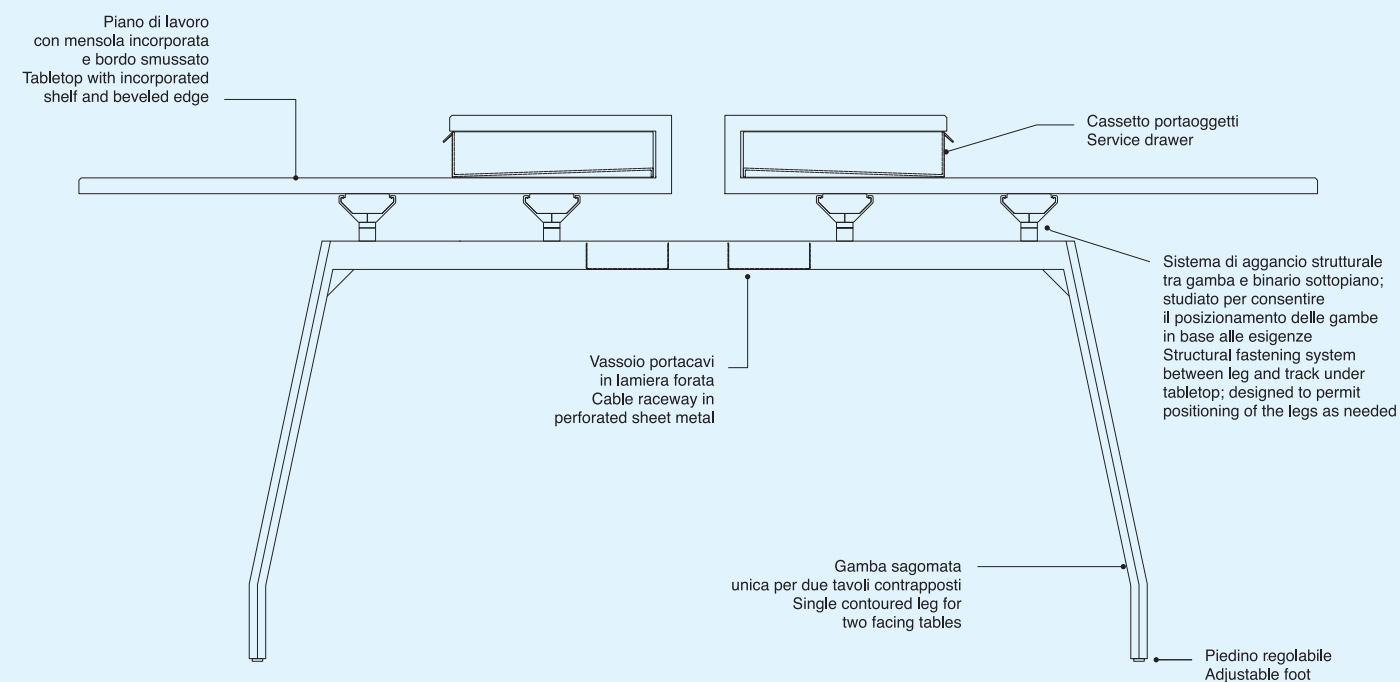
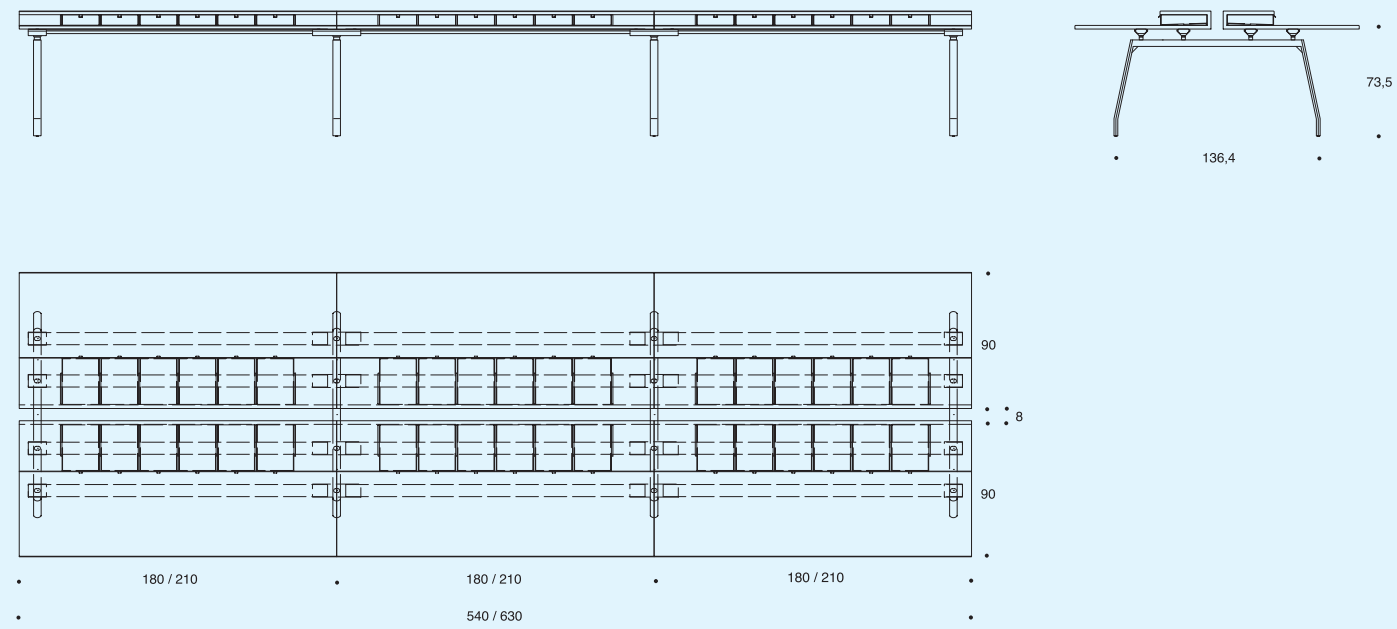

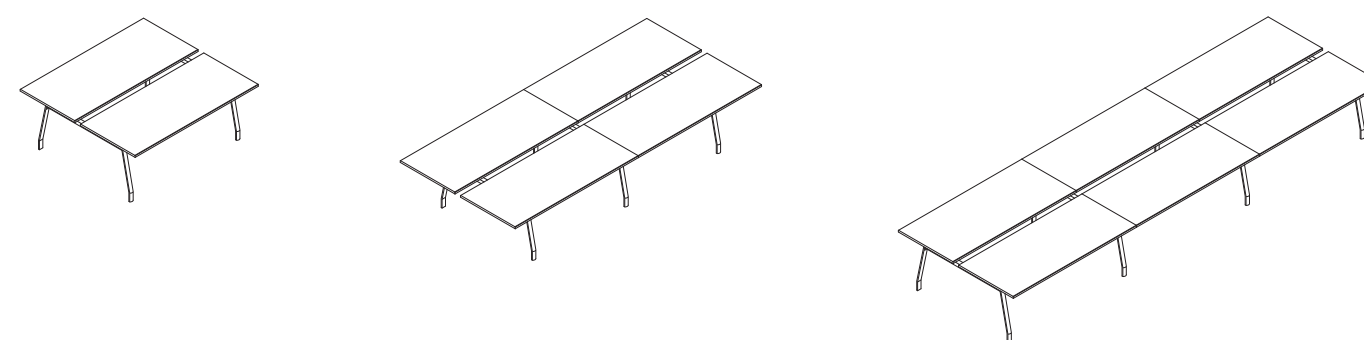
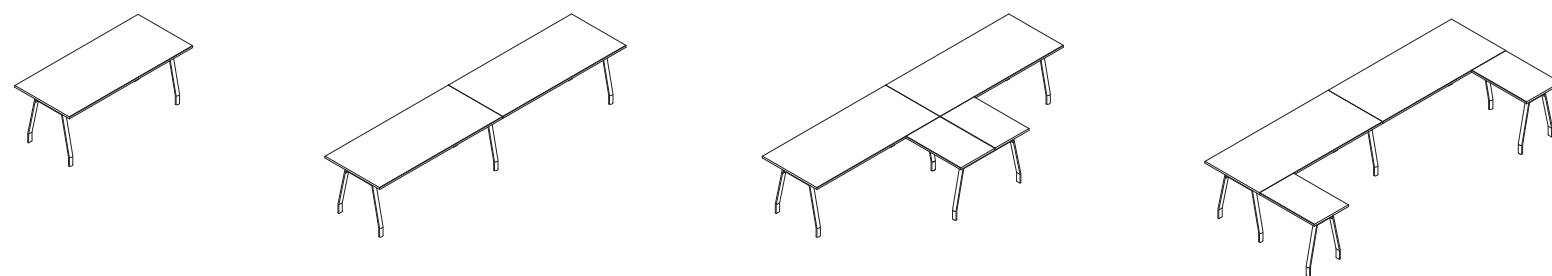

MDL System_Basic

Qualificato da forme essenziali, modularità ed elevate prestazioni di stabilità e flessibilità strutturale, il sistema permette di realizzare soluzioni tipologiche differenziate, in grado di rispondere a precise esigenze funzionali. Configurazioni operative a spazio aperto e postazioni aggregate in linea e fronteggianti disegnano l'ambiente di lavoro e organizzano le attività, adeguandosi, volta per volta, a situazioni diverse. Pochi componenti di un unico sistema costruttivo si combinano con semplicità per risolvere ogni aspetto progettuale. La struttura metallica, costituita da binari sottopiano e gambe sagomate in estruso di alluminio anodizzato lucido o verniciato grigio platino, è dotata di un particolare sistema di fissaggio che consente di posizionare i vari elementi secondo necessità.

Qualified by essential shapes, modular construction and high performance in terms of stability and structural flexibility, the system permits the development of differentiated customized solutions to respond to specific functional needs. Open-space configurations and clustered workstations in line and facing design a work environment and organize activities, adapting, case by case, to different situations. A few components in a single construction system make it easy to combine and resolve every project aspect. The metallic structure, consisting of tracks under the tops and contoured legs in extruded anodized aluminum, polished or painted platinum grey, is equipped with a special fastening system that makes it possible to position the different elements as needed.



Accuratamente disegnati in ogni minimo dettaglio, gli elementi strutturali (gamba sagomata, binario sottopiano e sistema di aggancio) danno una forte connotazione estetica al progetto caratterizzandolo sul piano del design con soluzioni di raffinata semplicità e leggerezza formale.

Accurately designed in every detail, the structural elements (contoured leg, track under the top and fastening system) give a strong esthetic connotation to the project, characterizing it on the design plane with solutions of refined simplicity and formal lightness.

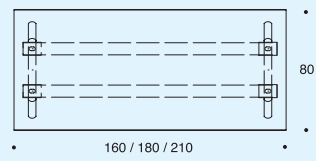
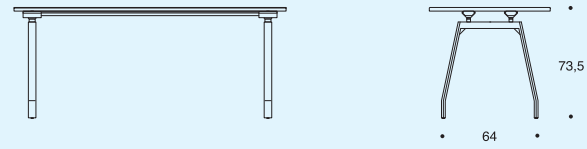

Piano di lavoro con bordo smussato
Tabletop with beveled edge

Sistema di aggancio strutturale tra gamba e binario sottopiano; studiato per consentire il posizionamento delle gambe in base alle esigenze; regolabile in altezza a cm 71,5-73,5-75,5
Structural fastening system between leg and track under tabletop; designed to permit positioning of the legs as needed; height adjustable: 71.5-73.5-75.5 cm

Gamba sagomata
Contoured leg

Binario strutturale sottopiano predisposto per il fissaggio delle gambe e di tutti gli accessori
Structural track under tabletop, equipped for fastening the legs and other accessories

Piedino regolabile
Adjustable foot





Nelle aggregazioni in linea, i tavoli contigui utilizzano un'unica gamba condivisa, dotata di sistema di aggancio strutturale allungato. Il piano di lavoro è impreziosito dal profilo smussato del bordo, ottenuto dalla lavorazione di un blocco di materiale omogeneo: massello di legno naturale oppure laminato ad alte prestazioni.

Consisting of modular elements in extruded anodized aluminum, polished or painted with epoxy powders, the load-bearing structure of the table can be combined in various ways. In the linear groupings, the adjacent tables share a leg, equipped with elongated structural fastening system. The tabletop is sophisticated with its beveled edges, obtained by processing a solid block of material: solid natural wood or high performance laminate.

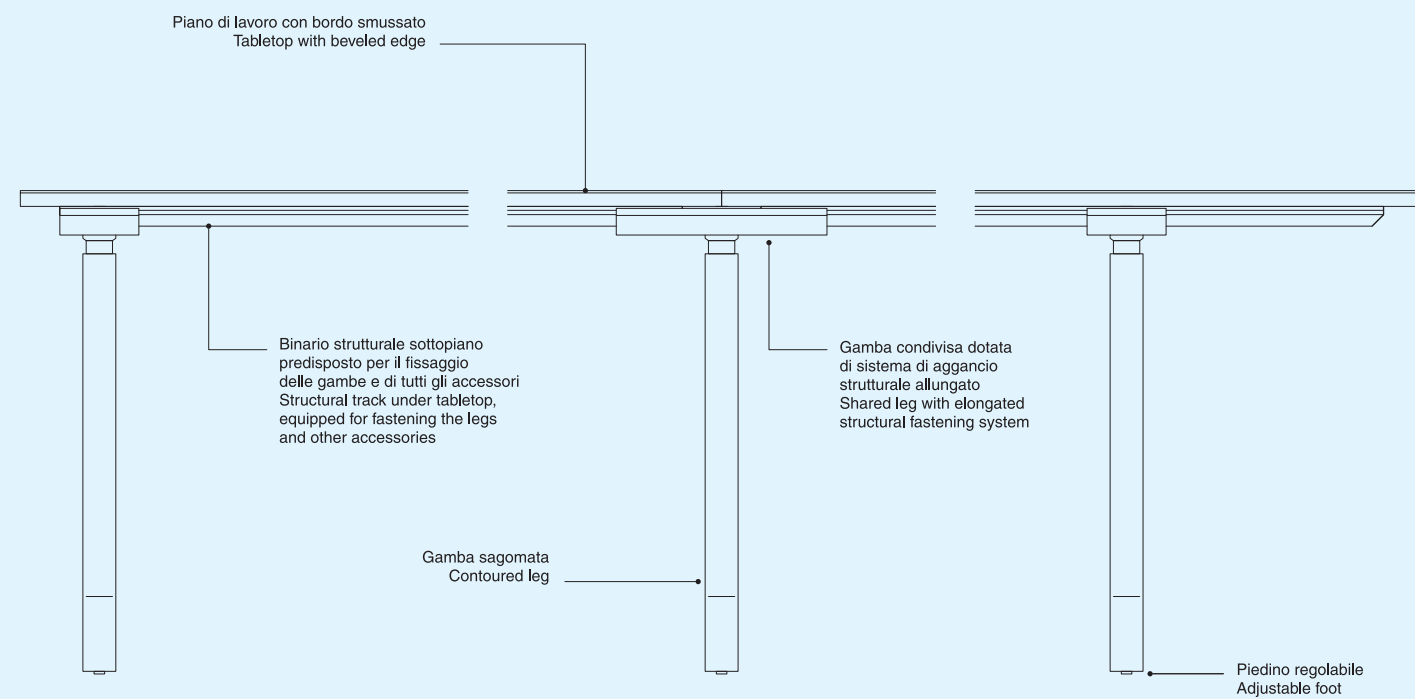
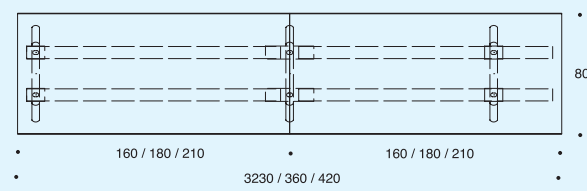
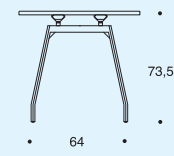
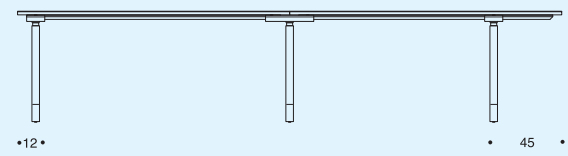

La combinazione tra tavoli aggregati in linea e piani di lavoro ausiliari permette di progettare soluzioni compositive e tipologiche diversificate per gli spazi operativi. La flessibilità del sistema costruttivo consente di razionalizzare la disposizione dei vari componenti, in modo da favorire la massima libertà nei movimenti.

The combination between clustered tables arranged in line and auxiliary table tops makes it possible to design diversified compositions and custom solutions for work areas. The flexibility of the construction system serves to rationalize the arrangement of the elements so as to facilitate the maximum freedom of movement.

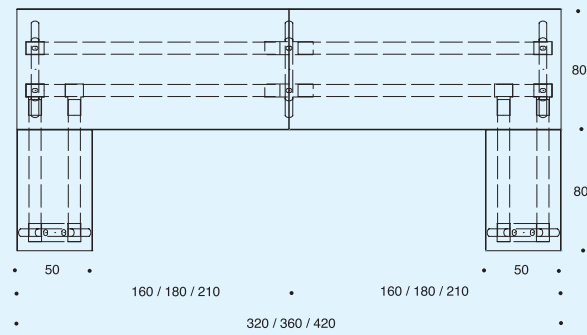
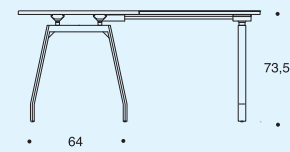
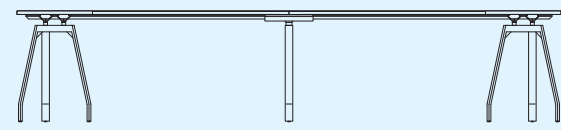
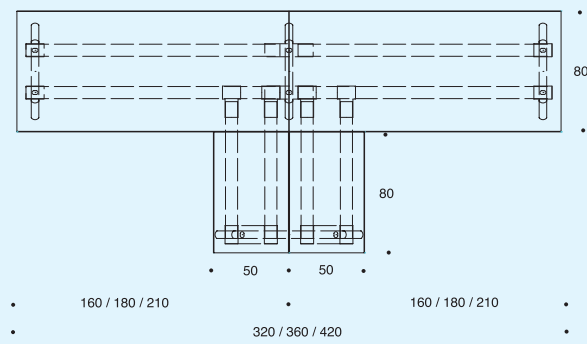
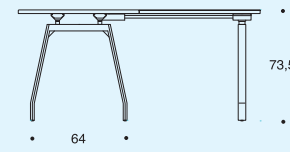
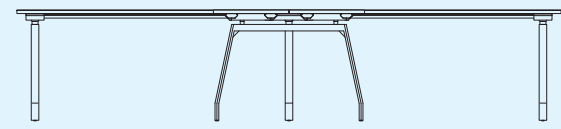

Ogni configurazione proposta è dotata di una serie di attrezzature funzionali. Realizzato in lamiera forata verniciata alle polveri epossidiche, il vassoio portacavi è agganciato alla sottostruttura metallica mediante uno speciale dispositivo di fissaggio a inclinazione controllata che facilita l'accessibilità.

Every configuration offered is equipped with a series of functional accessories. Produced in perforated sheet metal painted with epoxy powders, the cable raceway is fastened to the metallic underside by means of a special fastening system with controlled tilt that facilitates access.

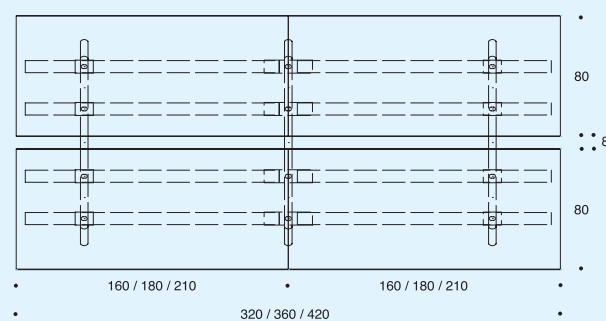
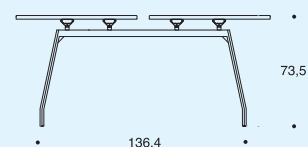
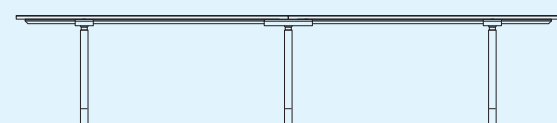
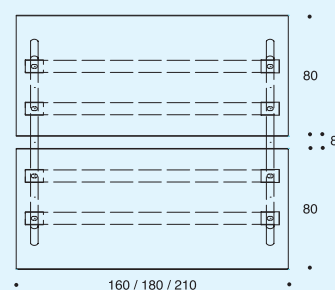
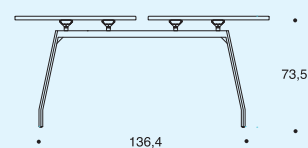
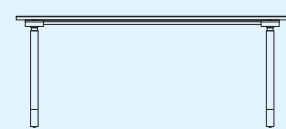

Una proposta che si caratterizza per essenzialità formale e flessibilità di utilizzo. I tavoli aggregati fronteggianti sono sostenuti da un'unica coppia di gambe sagomate, in modo da alleggerire notevolmente la composizione sia sul piano estetico che strutturale, pur garantendo sempre le necessarie prestazioni tecniche e di sicurezza.

A proposal characterized for formal minimalism and flexibility of use. Tables clustered facing each other are supported by a single pair of contoured legs, so as to greatly lighten the composition on the esthetic and structural plane, while always ensuring the necessary technical performance and safety.

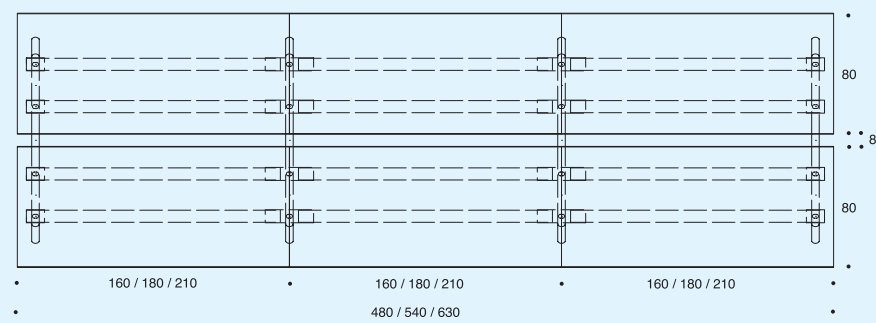
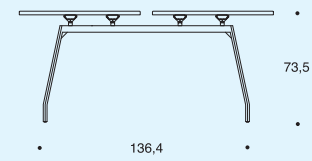
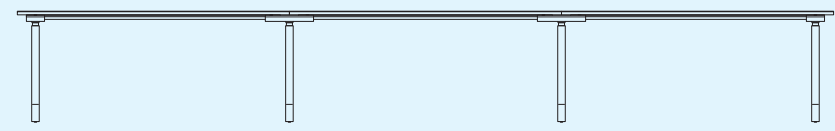

Piano di lavoro con bordo smussato
Tabletop with beveled edge

Binario strutturale sottopiano predisposto per il fissaggio delle gambe e di tutti gli accessori
Structural track under tabletop, equipped for fastening the legs and other accessories

Vassoio portacavi in lamiera forata
Cable raceway in perforated sheet metal

Gamba sagomata unica per due tavoli contrapposti
Single contoured leg for two facing tables

Piedino regolabile
Adjustable foot

Sistema di aggancio strutturale tra gamba e binario sottopiano; studiato per consentire il posizionamento delle gambe in base alle esigenze
Structural fastening system between leg and track under tabletop; designed to permit positioning of the legs as needed



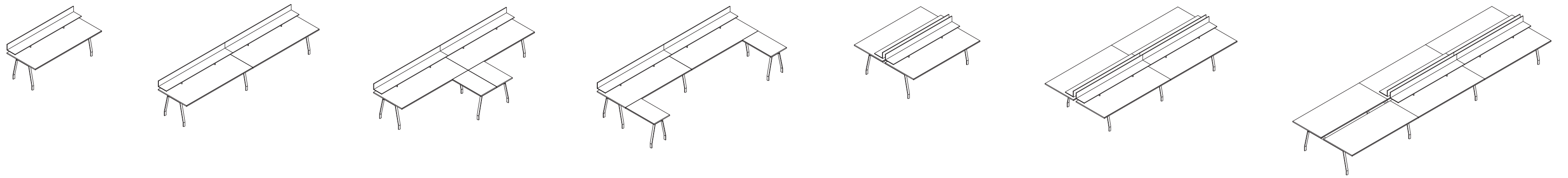

MDL System_Basic Plus

Leggerezza formale e grande funzionalità definiscono un ambiente operativo razionale e confortevole. Uno spazio flessibile e dinamico, capace di trasformarsi continuamente per soddisfare necessità di utilizzo differenziate. Un ufficio moderno, disegnato da una linea di arredi di nuova concezione. Un sistema componibile, pensato per rendere ogni postazione autonoma. Moduli scrivania attrezzati con mensola di servizio, vassoio per la canalizzazione degli impianti di rete, piano di lavoro ausiliario e cassetiera su ruote. Un programma di tavoli e complementi funzionali che consente di personalizzare ogni intervento su specifiche esigenze di progetto.

Formal lightness and highly functional design define an efficient, comfortable office environment. Flexible, dynamic use of space, capable of continuous transformation to satisfy differentiated needs of use. A modern office, designed in a line of furniture with a whole new concept. A modular system conceived to render every workstation independent. Desk modules equipped with service shelf, raceway for the network cables, auxiliary top and file cabinet on wheels. A functional line of tables and accessories that can be customized as needed to meet specific project demands.



Realizzata con gli stessi materiali del tavolo (laminato ad alte prestazioni o legno naturale), la mensola sospesa è fissata direttamente al piano mediante speciali supporti strutturali in alluminio anodizzato lucido. La postazione di lavoro, caratterizzata da una forte connotazione funzionale, si qualifica per la leggerezza formale e la completezza delle dotazioni.

Produced with the same materials as the table (high performance laminate or natural wood), the suspended shelf is fastened directly to the table by special structural supports in polished anodized aluminum. The workstation, characterized by a strong functional connotation, is qualified for formal lightness and completeness of the accessories.

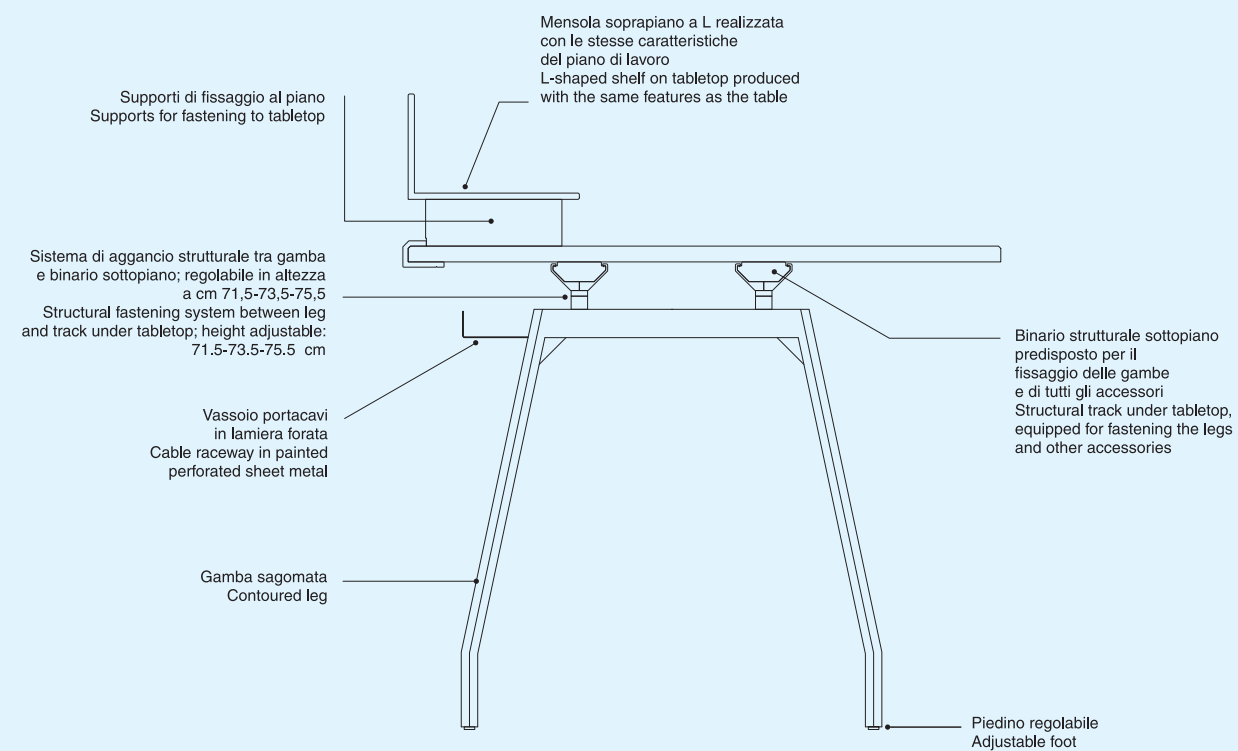
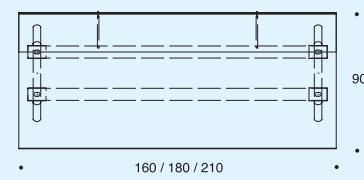
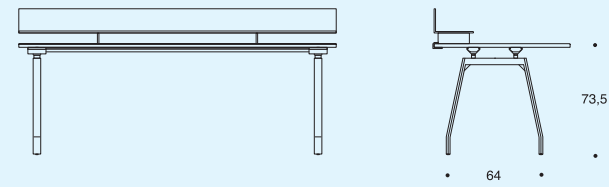

Le soluzioni strutturali sono semplificate dalla flessibilità del sistema costruttivo che consente di realizzare composizioni aggregate fronteggianti utilizzando un numero limitato di componenti: i tavoli contrapposti sono sostenuti da un'unica coppia di gambe sagomate. A livello funzionale, ogni postazione è attrezzata con mensola sospesa, vano di servizio al piano e vassoio portacavi.

The structural solutions are simplified by the flexibility of the construction system that makes it possible to produce clustered arrangement facing each other, using a limited number of elements: the facing tables are supported by a single pair of contoured legs. At the functional level, every workstation is equipped with suspended shelf, service compartment on the table and cable raceway.

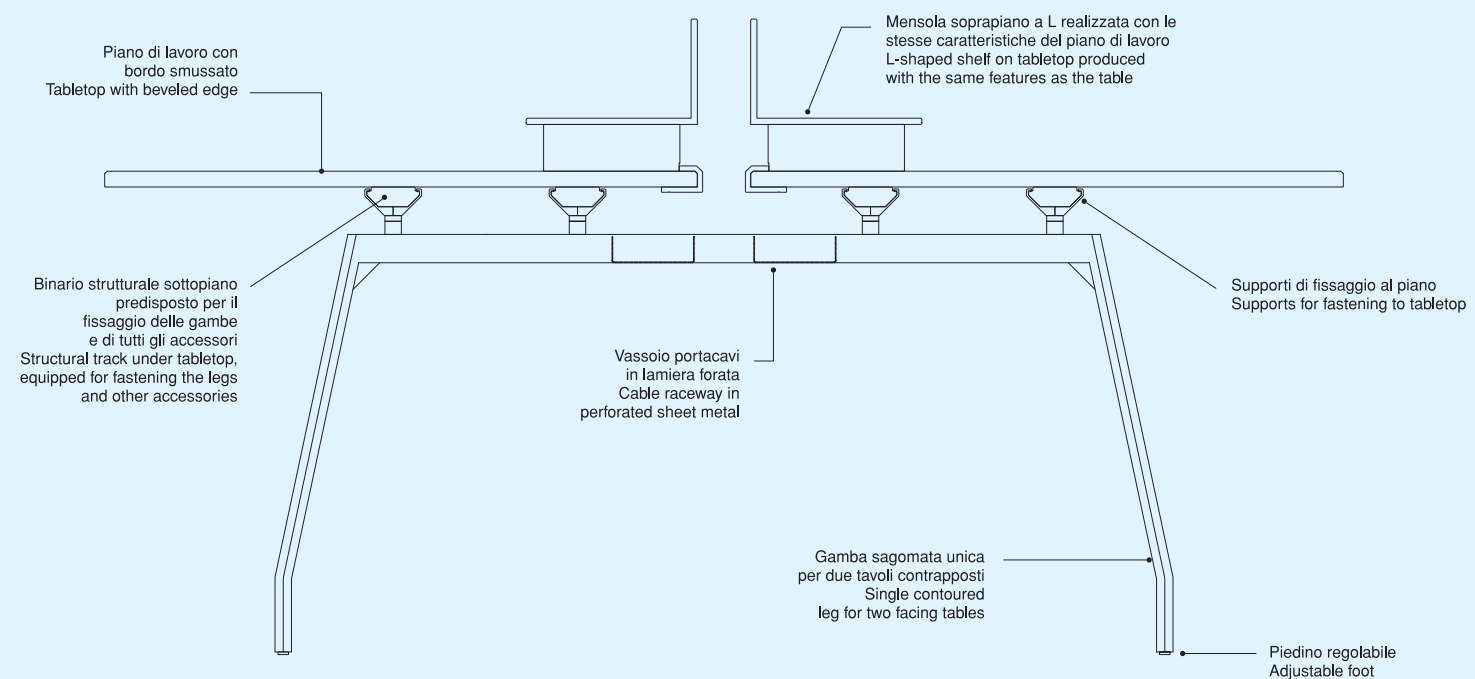
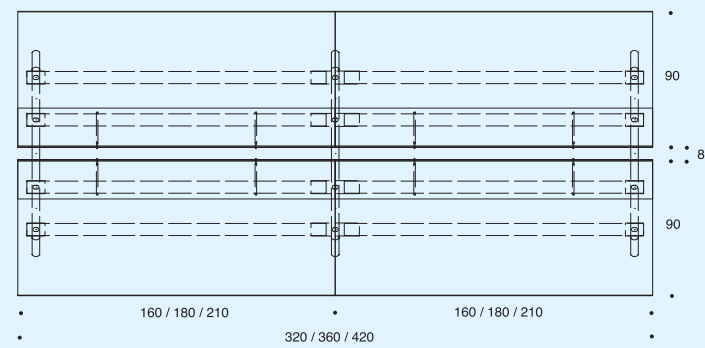
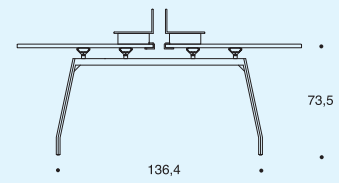
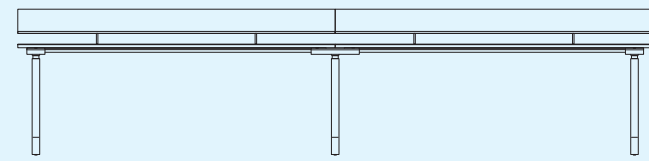

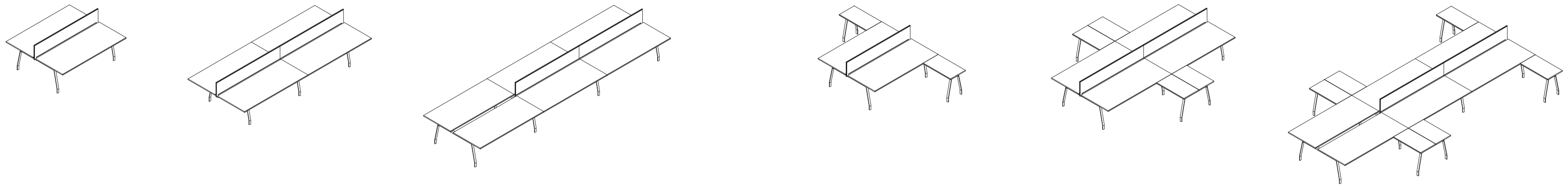

MDL System_Basic Glass

I tavoli operativi, aggregati in configurazioni a due, a quattro e a sei, possono essere separati da elementi di schermatura in vetrocamera acidato, agganciati alla struttura metallica. Questi pannelli divisorii, oltre a garantire una maggiore riservatezza e migliori prestazioni di comfort, si possono attrezzare con una linea di accessori in grado di incrementare ulteriormente la dotazione funzionale di ogni postazione di lavoro. Il telaio strutturale in policarbonato è predisposto per accogliere una serie di contenitori pensili (raccoglitori e vaschette) e un innovativo braccio snodato che consente il fissaggio e il corretto posizionamento dei monitor.

The work tables, clustered in configurations of two, four and six modules, can be separated by screening elements in acid-finished sandwich glass, fastened to the metallic structure. These partitions, in addition to ensuring greater privacy and comfort, can be equipped with a line of accessories to further increase the functional equipment of every workstation. The structural frame in polycarbonate is built to hold a set of hanging containers (trays and folders) and an innovative, hinged arm makes it possible to fasten monitors in the ideal position.



I tavoli sono separati da uno schermo divisorio a media altezza in vetrocamera acidato con telaio in policarbonato, sostenuto da un binario di supporto collegato alla struttura metallica. Studiato per proteggere maggiormente le postazioni, il pannello è predisposto per l'aggancio di mensole, contenitori pensili (raccoglitori e vaschette) e braccio snodato per il fissaggio e il corretto posizionamento dei monitor.

The tables are separated by a partitioning screen of moderate height in acid-finished sandwich glass with polycarbonate frame, supported by a track connected to the metallic structure. Designed to ensure greater protection of the workstations and improve noise abatement, the panel is built to hold a set of shelves, hanging containers (trays and folders) and hinged arms for fastening monitors and positioning monitors correctly.

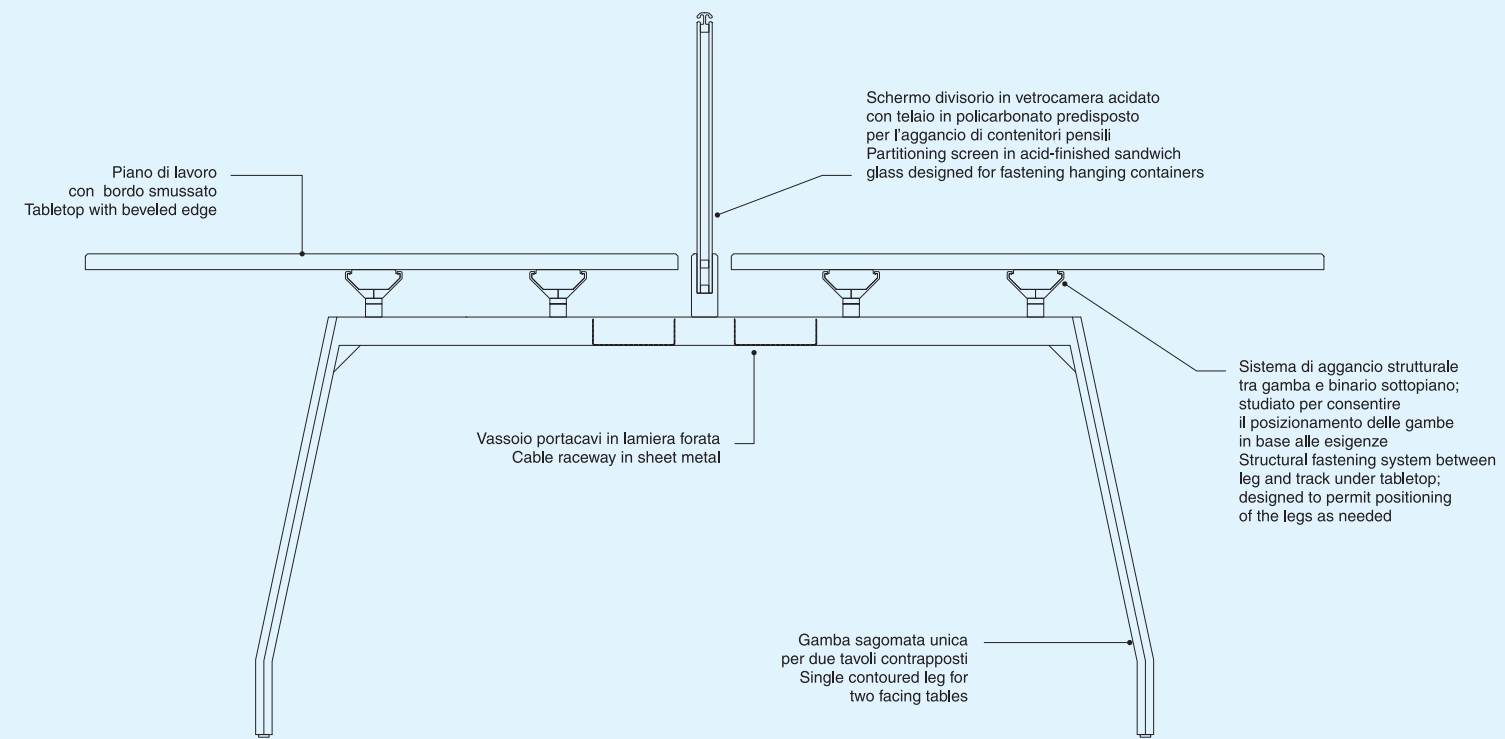
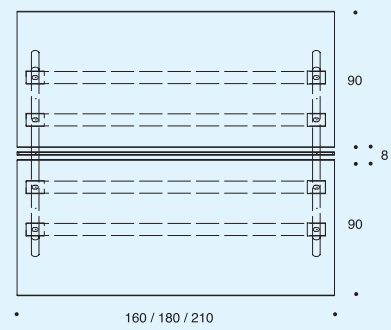
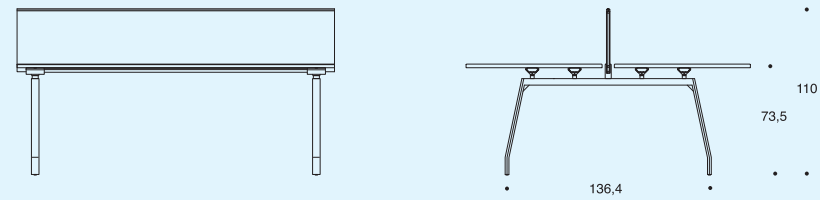



Realizzati in laminato ad alte prestazioni o in legno naturale, lo schermo di protezione sottopiano, il pannello divisorio a media altezza e la mensola integrata sono agganciati alla sottostruttura metallica oppure direttamente al piano di lavoro mediante speciali elementi di supporto in alluminio anodizzato lucido o verniciato.

Produced in high performance laminate or natural wood, the protective screen under the tabletop, the partitioning panels and integrated shelf are fastened to the metallic underside or directly to the tabletop with special supporting elements in polished or painted anodized aluminum.

MDL System_Accessories

Le postazioni individuali si possono attrezzare con accessori funzionali che qualificano le varie tipologie di utilizzo: scrivanie operative, tavoli segreteria, banchi reception. Fissati direttamente alla struttura metallica o al piano, i pannelli di schermatura sottopiano, gli elementi divisori frontali e le mensole di servizio sono disponibili in varie finiture e dimensioni, consentendo ulteriori livelli di personalizzazione.

The individual workstations can be equipped with functional accessories that qualified various types of use: operating desks, secretarial tables, reception desks. Fastened directly to the metallic structure or table top, the screening panels under the table, the frontal partitions and the service shelves are available in different finishes and sizes, for additional levels of customization.

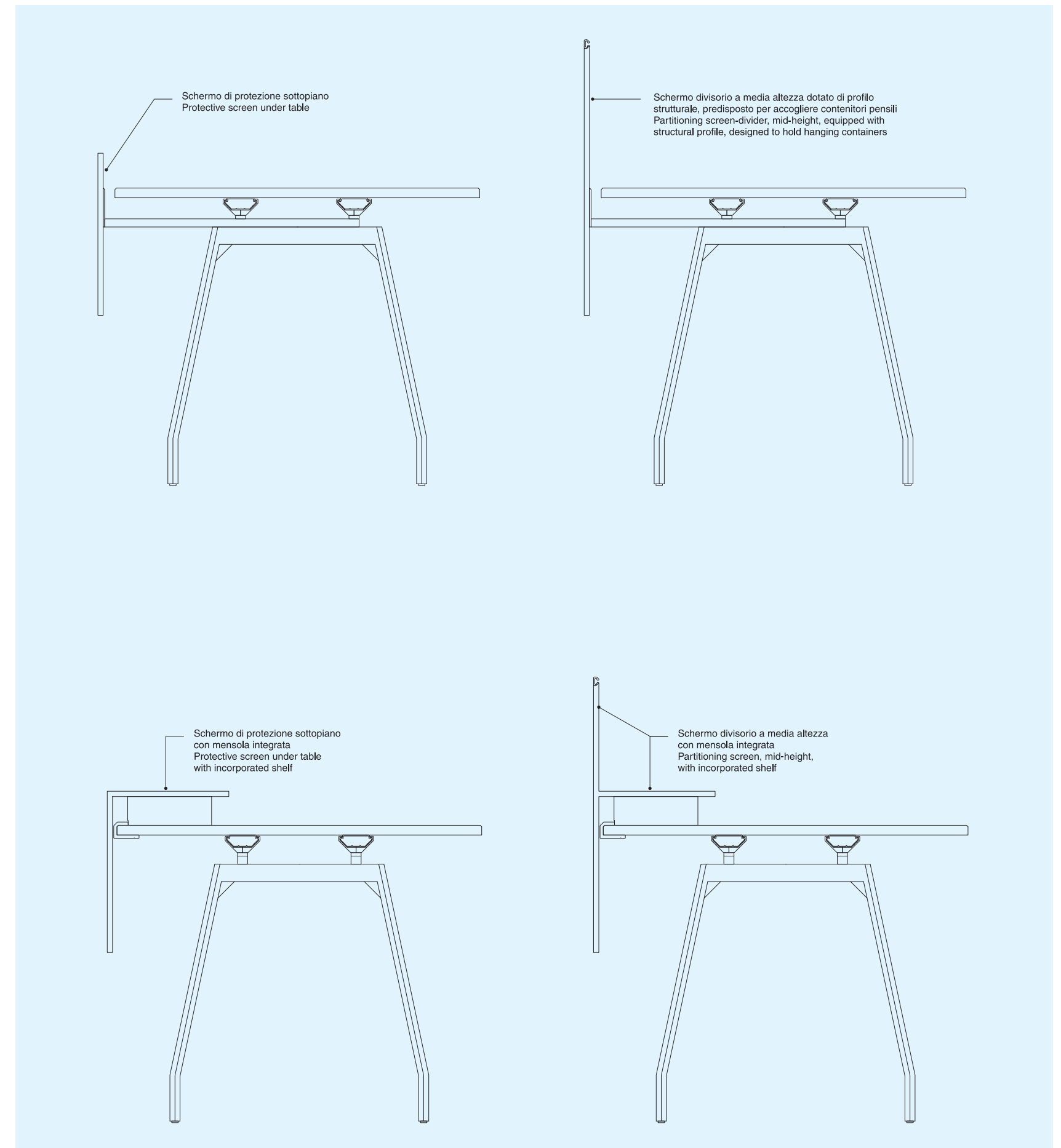



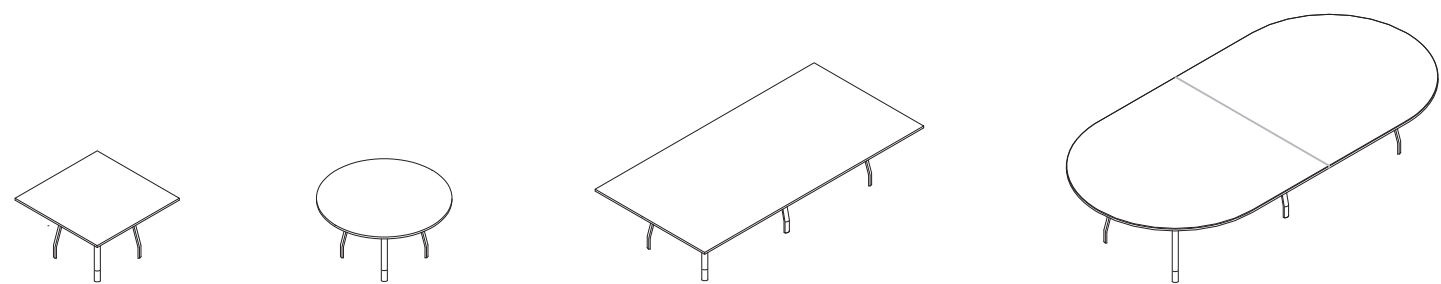

MDL System_Meeting

Il programma comprende una serie diversificata di tavoli per riunioni, disponibili in un'ampia gamma morfologica e dimensionale che consente di soddisfare le esigenze degli ambienti di lavoro contemporanei dedicati alla comunicazione e alla relazione tra le persone. Luoghi d'incontro, spazi per gruppi operativi, zone di supporto per il personale di transito, biblioteche, uffici direzionali, sale per conferenze e videoproiezioni... Ogni applicazione si caratterizza per leggerezza formale, elevate prestazioni tecniche e grande qualità ambientale. Il tavolo, costituito da una robusta struttura metallica e un elegante piano con bordo smussato, può essere attrezzato con vano tecnico sottopiano, predisposto per l'allacciamento alla rete (elettrica, telefonica, dati) e accessibile mediante un pratico sportello a filo piano.

The program includes a diversified series of conference tables, available in a wide morphological and dimensional range to satisfy the needs of contemporary office environments devoted to communications and interpersonal relations. Meeting places, spaces for work groups, support areas for personnel in transit, libraries, executive offices, conference halls and video projection rooms... Every application is characterized by formal lightness, high technical performance and appropriate environmental quality. The table, consisting of a sturdy metallic structure and elegant top with beveled edge, can be equipped with a technical compartment under the top, designed for the connection to power, telephone and data networks, and accessible through a practical hatch flush with the top.







MDL System

Full

G D L P I 1 1 8 0 9 0 A

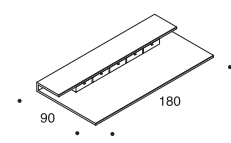

G D L P I 2 1 1 0 9 0 A

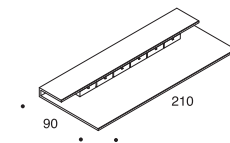

G D L P I 1 1 8 0 9 0 A D

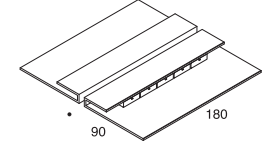

G D L P I 2 1 1 0 9 0 A D

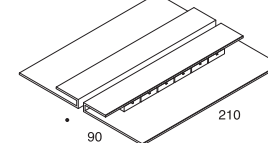

Basic

G D L P I 1 1 6 0 8 0

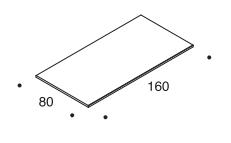

G D L P I 1 1 8 0 8 0

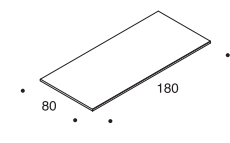

G D L P I 2 1 1 0 8 0

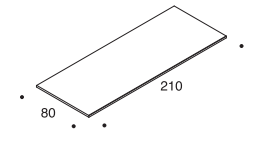

G D L P I 0 8 0 5 0 L

G D L P I 0 8 0 6 0 L

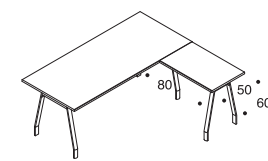

G D L P I 1 1 6 0 8 0 D

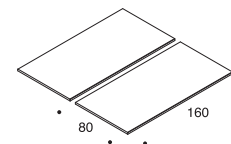

G D L P I 1 1 8 0 8 0 D

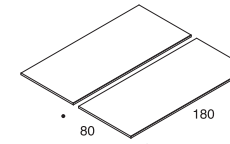

G D L P I 2 1 1 0 8 0 D

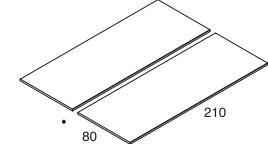

G D L P I 1 1 6 0 9 0

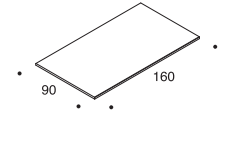

G D L P I 1 1 8 0 9 0

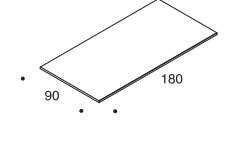

G D L P I 2 1 1 0 9 0

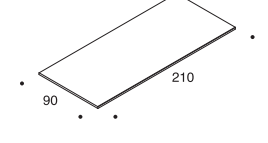

G D L P I 0 9 0 5 0 L

G D L P I 0 9 0 6 0 L

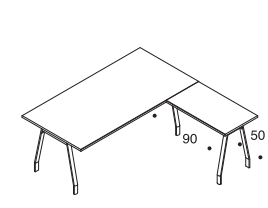

G D L P I 1 1 6 0 9 0 D

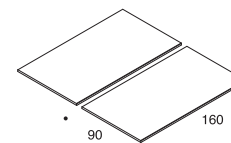

G D L P I 1 1 8 0 9 0 D

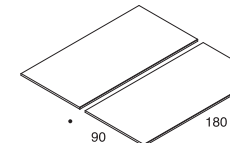

G D L P I 2 1 1 0 9 0 D

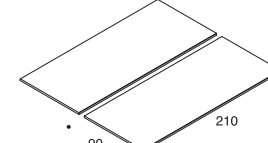

G D L G A 1 6 4



G D L G A 1 6 4 I I

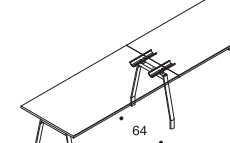

G D L G A 1 4 8 L

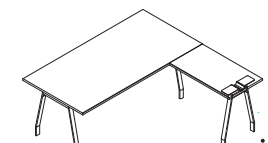

G D L D G

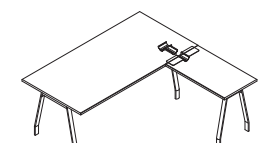

G D L G A 1 3 6 D

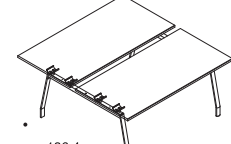

G D L G A 1 3 6 D I I

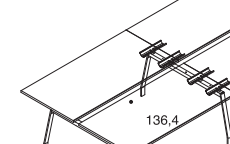

Basic Plus

G D L M E 1 1 6 0

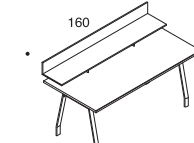

G D L M E 1 1 8 0

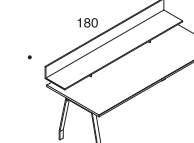

G D L M E 2 1 1 0

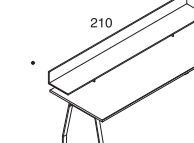

Basic Glass

G D L S C 1 1 6 0 3 1 6

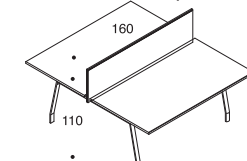

G D L S C 1 1 8 0 3 1 6

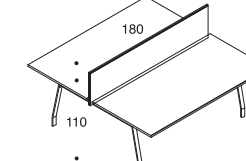

G D L S C 2 1 1 0 3 1 6

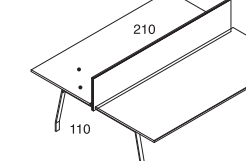

Accessories

G D L P M 1 1 6 0

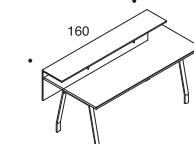

G D L P M 1 1 8 0

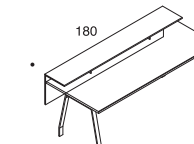

G D L P M 2 1 1 0

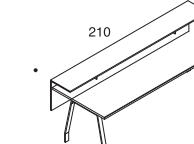

G D L P F A 1 1 6 0

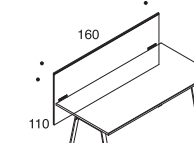

G D L P F A 1 1 8 0

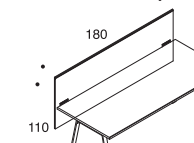

G D L P F A 2 1 1 0

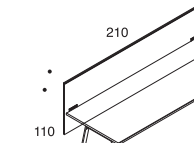

G D L P M A 1 1 6 0

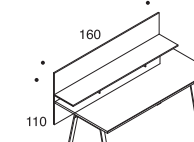

G D L P M A 1 1 8 0

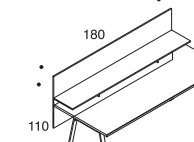

G D L P M A 2 1 1 0

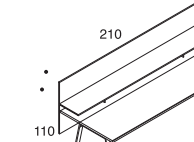

G D L A U N I T

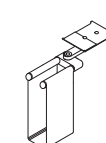

G D L A F I S I P

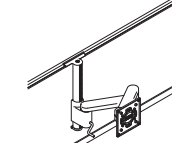

G D L A F I S I T

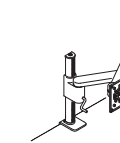

G D L W B 7 5

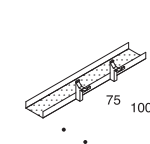

G D L W B 1 1 2 5

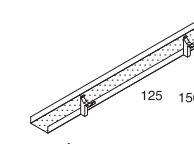

G D L W B 2 1 0

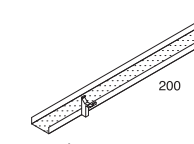

Meeting

G D L L 1 0 8 0 R

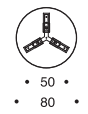

G D L L 0 9 0 R

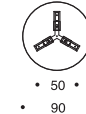

G D L L 1 1 0 0 R

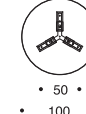

G D L L 1 0 0 Q

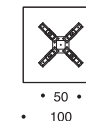

G D L L 1 2 0 R

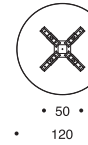

G D L L 1 8 0 1 1 2 0 S

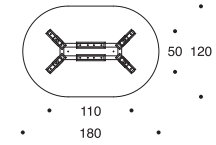

G D L L 2 4 0 1 1 2 0 S

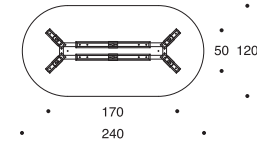

G D L L 1 2 0 Q

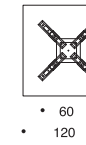

G D L L 1 8 0 1 1 2 0 Q

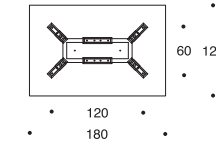

G D L L 2 4 0 1 1 2 0 Q

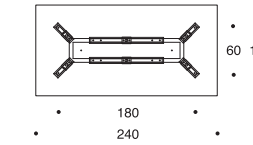

G D L L 1 4 0 R



G D L L 2 1 0 1 1 4 0 S

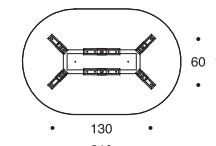

G D L L 2 8 0 1 1 4 0 S

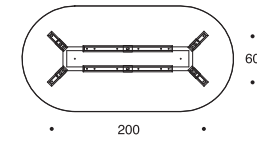

G D L L 1 4 0 Q

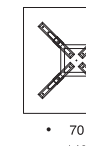

G D L L 2 1 0 1 1 4 0 Q

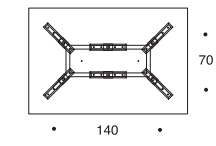

G D L L 2 8 0 1 1 4 0 Q

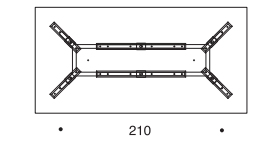

G D L L 1 6 0 R

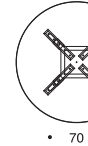

G D L L 2 4 0 1 1 6 0 S

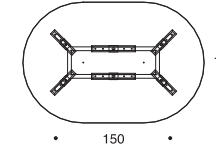

G D L L 3 2 0 1 1 6 0 S

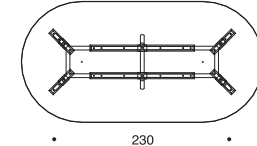

G D L L 1 6 0 Q

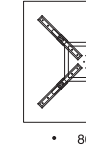

G D L L 2 4 0 1 1 6 0 Q

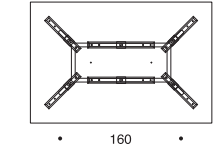

G D L L 3 2 0 1 1 6 0 Q

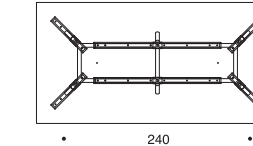

G D L L 1 8 0 R



G D L L 2 7 0 1 1 8 0 S

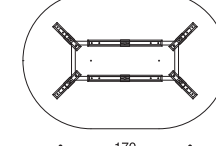

G D L L 3 6 0 1 1 8 0 S

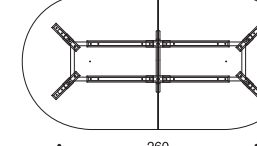

G D L L 1 8 0 Q

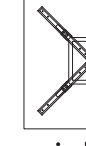

G D L L 2 7 0 1 1 8 0 Q

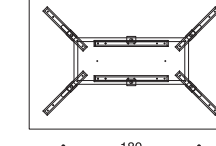

G D L L 3 6 0 1 1 8 0 Q

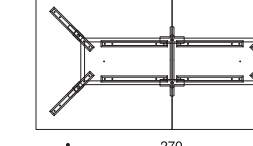

Piani
 GP Laminato Grigio Platino
 RV Rovere Naturale

Strutture
 BA Alluminio Brillantato
 NA Alluminio Anodizzato Naturale
 VP Grigio Platino

Tops
 GP Platinum Grey Laminato
 RV Natural Oak

Structures
 BA Aluminium Glossy
 NA Anodized Aluminium Natural
 VP Platinum Grey

UNIFOR

Stabilimento e uffici

22078 Turate (Como)
via Isonzo 1
tel. (02) 967 191
fax (02) 967 50859
(02) 967 50399
www.unifor.it
e-mail: unifor@unifor.it

Filiali italiane

20121 Milano
corso Matteotti 14
tel. (02) 7600 9024
fax (02) 7600 4765
e-mail: uniformilano@unifor.it

00173 Roma
via Tuscolana 1788
tel. (06) 721 0505-721 0479
fax (06) 721 1487
e-mail: uniforroma@unifor.it

Agenzie italiane

70121 Bari
piazza Eroi del Mare 6
tel. (080) 5249373
fax (080) 5249484
e-mail: stecchi.system@tin.it

40128 Bologna
via del Lavoro 60
tel. (051) 631 1368
fax (051) 631 1370
e-mail: info@progetto-ufficio.com

39100 Bolzano
via Esperanto 3
tel. (0471) 050 505
fax (0471) 050 500
e-mail: info@arteobject.it

42040 Campegine (Reggio Emilia)
via Aldo Moro 8
tel. (0522) 906 154
fax (0522) 906 697
e-mail: prouf@tin.it

36030 Costabissara (Vicenza)
via Pasubio 17
tel. (0444) 557 894
fax (0444) 557 073
e-mail: fontanacontract@fontanasrl.net

80121 Napoli
via Carlo Poerio 34
tel. (081) 245 2439
fax (081) 245 2439
e-mail: fontanellanicola@virgilio.it

35020 Padova Z.I.
Loc. Saonara
via Irpinia 56
tel. (049) 879 1870
fax (049) 879 1871
e-mail: info@ambienteufficio.it

90146 Palermo
via San Lorenzo, 155/161
tel. (091) 689 0738
fax (091) 751 0656
e-mail: mail@massimilianotroja.com

06100 Perugia
via Mario Angeloni 65
tel. (075) 500 2715
fax (075) 500 8984
e-mail: perugia@koretiarredamenti.it

51100 Pistoia
via N. Machiavelli 25
tel. (0573) 975 458
fax (0573) 975 488
e-mail: info@logosformiture.it

33047 Remanzacco (Udine)
Strada di Osellin 78
tel. (0432) 649 232
fax (0432) 668 633
e-mail: info@multitema.it

24040 Stezzano (Bergamo)
via Circonvallazione Ovest 24
tel. (035) 454 0450
fax (035) 454 0460
e-mail: info@rova.it

61010 Tavullia (Pesaro)
via Selvagrossa 24/26
loc. Case bruciate
tel. (0721) 201366
fax (0721) 202483
e-mail: dellachiara@dellachiara.it

38100 Trento
via Dosso Dossi 4
tel. (0461) 828 900
fax (0461) 828 901
e-mail: info@habitat-ufficio.it

31100 Treviso
via Ponchielli 2
tel. (0422) 262 223
fax (0422) 262 386
e-mail: sagola@tin.it

37138 Verona
via Albere 47/A
tel. (045) 567 066
fax (045) 572 041
e-mail: centrufficioverona@tiscali.it

Filiali estere

Australia
Unifor Australia Pty Ltd
140 Bank Street
Pyrmont, N.S.W. 2009
tel. (02) 9552 9552
fax (02) 9552 9553
e-mail: sydney@uniforaust.com

Unifor Melbourne Office
450 Latrobe Street
Melbourne Victoria 3000
C/o Phoenix Lane
tel. (03) 9329 5900
fax (03) 9329 9766
e-mail: melbourne@uniforaust.com

France
Unifor France S.A.
6 rue des Saints Péres
75007 Paris
14 rue Pierre Nicolau
93582 Saint Ouen (Cedex)
tel. (01) 4012 7717
fax (01) 4010 0124
e-mail: unifor@unifor.fr

Great Britain
Ergonom Ltd.
Whittington House
19-30 Alfred Place
London WC1E 7EA
tel. (0207) 3232 325
fax (0207) 3232 032
e-mail: enquiry@ergonom.com

Hong Kong
Unifor Hong Kong Ltd.
19th Floor
Top Glory Tower
262 Gloucester Road
Hong Kong
tel. (852) 2836 9333
fax (852) 2836 9997
e-mail: unifor@unifor.com,hk

Singapore/Malaysia
Unifor Singapore Pte Ltd
11 Keppel Road
01-01 RCL Centre
Singapore 089057
tel. (65) 6221 1822
fax (65) 6221 1833
e-mail: general@unifor-asia.com

U.S.A.
Unifor
149 Fifth Avenue
New York, NY 10010
tel. (212) 673 3434
fax (212) 673 7317
e-mail: unifor@uniforusa.com

Rappresentanze estere

Austria
Pfau
Am Gestade
A-1010 Wien
tel. (01) 535 4075
fax (01) 535 40759
e-mail: office@pfau.com

Bahrain
Pico international
Po. box 13990 Muharraq Bahrain
tel. 218 898
fax 226 555
e-mail: picobah@batelco.com,bh

Belgium
SV Interior Projects NV/SA
Koningin Astridlaan 59
Avenue Reine Astrid
B-1780 Wommel
tel. (02) 531 1350
fax (02) 531 1351
e-mail: info@sv.be

Canada
ItaInteriors Contract
276 King Street West
Suite 30
Toronto, Ontario M5V 1J2
tel. (0416) 364 1011
fax (0416) 364 7978
e-mail: info@italinteriors.com

Chile
Muzard S.A.
Merced 26
Santiago
tel. (02) 639 1421
fax (02) 639 1958
e-mail: miguel@muzard.com

Croazia
Art Avantgarde
ilica 15
Zagreb HR
tel. (1) 48 12 900
fax (1) 48 17 217
e-mail: aag.dizain.centar@zg.hinet.hr

Erceg Interijeri
Uprava I Salon Namjestaja
Selska cesta 14
10000 Zagreb
Tel. (1) 3702 166
Fax (1) 3702 167
e-mail: erceg-interijeri@zg.htnet.hr

Czech Republic
Konsepti
Komunardu 32
170 00 Praha 7
tel. (0222) 326 928
fax (0222) 321 358
e-mail: studio@konsepti.cz

Denmark
Hans Due Design AS
Rungstedvej 16
DK-2970 Horsholm
tel. (0045) 4576 1516
fax (0045) 4576 1517
e-mail: hdi@hansduedesign.dk

Dubai
Al Reyami Group
Po. box 14662 Dubai
tel. (4) 336 4666
fax (4) 336 6775
e-mail: rol@emirates.net.ae

Germany
Uni.Projekt
Vertriebsgesellschaft mbH
Tulpenweg 4
93138 Lappersdorf
tel. (0941) 897 9082
fax (0941) 897 9085
e-mail: info@unifor.de

Showroom
Charlottenstr. 77
10117 Berlin
tel. (030) 8804 790
fax (030) 8804 7920
e-mail: vb.berlin@unifor.de

Greece
Avepe S.A.
11-13, Sina Street
10680 Athens
tel. (30) 6957 507853
e-mail: unifor@avepe.gr

Holland
SV Interieur Groep
Terbregse Rechter
Rottekade 137
3055 XC Rotterdam
tel. (010) 211 2050
fax (010) 422 3495
e-mail: info@sv.nl

Showroom
Dorpsstraat 75
1182 JC Amstelveen
tel. (020) 347 2130
fax (020) 647 0095

Hungary
Sincord Ltd.
Ujvilág u. 50-52
H-1145 Budapest
tel. (01) 469 6970
fax (01) 469 6971
e-mail: sincord@sincord.hu

India
C.E.O.
S-13, Shree Laxmi Woolen Mills
2nd Floor, Shakti Mills Lane
Off E. Moses Road
Mahalaxmi
Mumbai 400011
Tel. (22) 65054436 / 24959000
Fax (22) 23517239
e-mail: ceo@ceo.net.in

Ireland
Project Office
1 Exchange Street Upper
Temple Bar West
Dublin 8
tel. (01) 671 5700
fax (01) 671 5701
e-mail: unifor@projectoffice.ie

Israel
Midua Engineering & Systems
36, Ein-hai Str., Kfar Malal
P.O. Box 1234
Hod-Hasharon 45111
tel. (09) 744 2881
fax (09) 744 2880
e-mail: midua@shani.net

Japan
Shukoh Co. Ltd.
Nihon Seimei Kawasaki Building
1-1, Minami-machi
Kawasaki-ku, Kawasaki-shi
210-0015 Kanagawa
tel. (044) 210 5123
fax (044) 246 9861
e-mail: sec@shukoh.co.jp

Showroom
Tokyo Design Center 7th floor
5-25-19, Higashi-Gotanda
Shinagawa-ku, Tokyo 141-0022
tel. (03) 5798 2231
fax (03) 5498 2232

Messico
Esencial
Polanco Goldsmith 60
11560 Mexico City
tel. (55) 5282 2034
e-mail: afernandez@esencial.com.mx

New Zealand
Cite Ltd.
18 Normandy Road
Mt Eden
Auckland 1001
tel. (09) 623 9233
fax. (09) 623 0233
e-mail: katrina@citetld.co.nz

Norway
Robert Tandberg
Postboks 538 Sentrum
N-0105 Oslo
Besøksadresse:
Dronningensgate 10-14
N-0152 Oslo
tel. (0047) 22473020
fax (0047) 22473021
e-mail: rune@roberttandberg.no

Portugal
Helder Gonçalves
Largo do C6 145
4595-298 Penamaioir
tel. (255) 866 001
fax (255) 866 002
e-mail: helder@spring.mail.pt

Qatar
Office System
P.O.Box: 14715
Doha
Tel. (974) 4324034
Fax (974) 4323746
email: adhamsi@office-system.net

Slovenija
I D
Slovenska c.9
1000 Ljubljana
tel. (061) 426 9030
fax (061) 426 9032
e-mail: info@id-online.net

Spain
Unifurniture, S.L.
c/. Casp. 46 Desp. 2º 1ª A
08010 Barcelona
tel. (093) 412 4635
fax (093) 412 4831
e-mail: info@unifurniture.net

Switzerland
Unitrend
Riedstrasse 1
CH-6343 Rotkreuz
tel. (041) 790 5454
fax (041) 790 5575
e-mail: info@unifor.ch

I prodotti illustrati nel presente catalogo sono conformi all'allegato 7 legge 626 e rispondenti alle principali norme UNI applicabili ai diversi tipi di prodotti.

I prodotti descritti nel catalogo sono composti da materiali in classe E1 (a basso contenuto di formaldeide) e sono conformi alle principali norme nazionali e internazionali.

The products illustrated in this catalog are made in strict compliance with annex 7 of Law 626 and respond to UNI norms that apply to different types of products.

The products described in this catalogue are made in strict compliance with annex 7 of Law 626 and conform to the principal National and International product norms.

Testi: Livio Salvadori
Foto: Mario Carrieri

Fotolito: Pluscolor
Stampa: Grafiche Mariano
Finito di stampare: Febbraio 2010

