

# TAYLORCRAFT

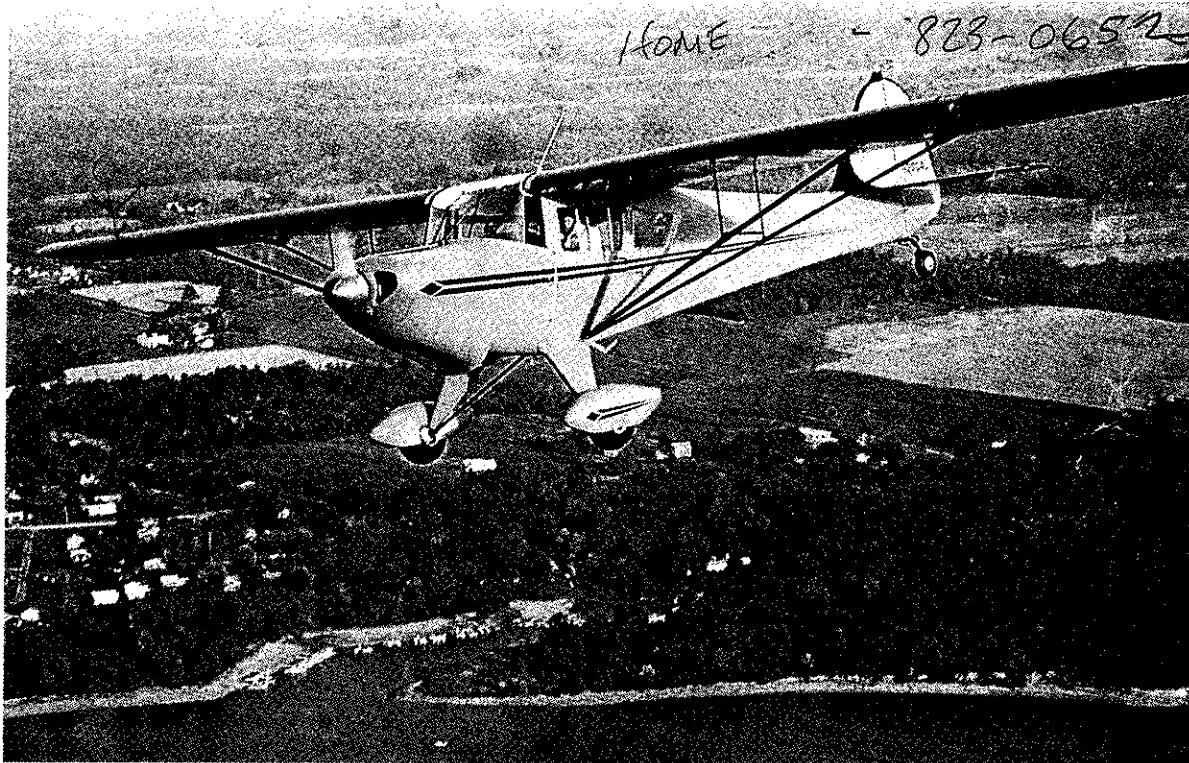

## AVIATION CORPORATION

820 EAST BALD EAGLE STREET  
P. O. BOX <sup>480</sup>~~947~~ LOCK HAVEN, PENNA. 17745  
PHONE (717) 748-~~6742~~ <sup>8262</sup>



*Taylorcraft Model F21—Lycoming O-235 L2C Engine*

## PARTS & PRICE LIST

"SERVICE TODAY MEANS SALES TOMORROW"

ELEVATOR SPAR  
1025

FIN POST  
1025

**ORDER INFORMATION**

**WHEN ORDERING, ALWAYS SPECIFY THE FOLLOWING:**

1. Year of manufacture, model, serial number and registration number.
2. Part name, number, type, and right or left hand. If you cannot identify the part by catalogue number, a sketch or picture and as much information as possible is necessary.
3. Method of Shipment. We ship the most convenient way unless otherwise specified.

for parts returned which are ordered in error. When returning merchandise to us, be sure to include date of purchase, invoice number, and full explanation for return. Credit will be issued only if the return is in new-excellent resaleable condition and with original container, if possible.

We are not responsible for lost or damaged freight which you may have shipped to us as return merchandise. You are responsible as the shipper to file claim against the carrier.

**PRICES:**

The prices quoted herein are our best prices and are F.O.B. our factory at ~~Alliance, Ohio~~ **LOK HAVEN, PA.**

As prices fluctuate with general conditions, all prices are subject to change without notice. Parts will be invoiced at prevailing prices at the time the orders are received.

**TERMS:**

Terms are cash and all orders will be sent COD unless check, money order or certified check accompanies order. Please include postage and state tax (if applicable) with paid orders. Surplus postage will be returned or credited to your account.

Canadian orders must be accompanied by Postal or Bank Money Order payable in U.S. currency, no personal checks, no COD's.

**RETURNS:**

No parts shall be returned without first securing written permission. All parts must be returned within thirty days. Transportation charges must be prepaid or returned parts or shipment will be refused. There will be a 10 per cent handling charge

**SHIPPING:**

For your protection, all shipments should be carefully inspected for intransit damage as soon as received, and any resulting claims should be filed with the carrier immediately. Be sure to have the driver sign a copy of the freight bill with damage noted. If Parcel Post, have the postmaster complete the necessary form. If goods are discovered damaged upon inspection after delivery, call the carrier immediately for an inspection report.

**Size Limits on Packages-Parcel Post**

Canada	72" Lgth. & girth combined
Alaska	100" Lgth. & girth combined
All other states	84" Lgth. & girth combined
United Parcel Service	108" Lgth. & girth combined

(Must have street address where UPS is available)

**NOTE:**

Shipments exceeding Parcel Post or United Parcel Service will be shipped via Motor Freight (See Order Form).

The Taylorcraft Aviation Corporation makes no warranty with respect to instruments, propellers, tires, wheels or other trade accessories, inasmuch as they are warranted by their respective manufacturers.

**INDEX**

	PAGE NO.
Engine Installation .....	3, 4
Cowling Installation .....	4, 5
Cowl Fasteners .....	5
Fuel System Installation — Engine .....	5
Fuel System Installation — Fuselage .....	5, 6
Fuel System Installation — Wing .....	6
Instrument & Engine Controls .....	6, 7
Flight Control .....	7
Placards .....	7, 8
Electrical System .....	8
Lighting Gear Installation .....	8, 9, 10
Hydraulic Brake System .....	10, 11
Maule Tailwheel .....	11
Heath Tailwheel & All Tailwheels .....	12
Brake Control & Parking Brake .....	12
Trim Tab Controls .....	12
Empennage Installation .....	12, 13

	PAGE NO.
Fairing & Stringer Installation .....	13
Seat Installation .....	13
Baggage Compartment & Headliner Bows — B Models .....	13
Floorboard Installation .....	13
Rear Window Installation — B Models .....	13
Headliner Installation — F19 & F21 Models .....	13
Baggage Compartment & Shoulder Harness Installation — F19 & F21 Models .....	14
Windshield .....	14
Metal Door Installation .....	14
Fuselage Framework .....	14
Wing Installation .....	14, 15, 16
Aileron Installation .....	16
Wing Struts & Trim .....	16, 17
Wheel Pants Installation .....	17
Miscellaneous .....	17
Pictures & Sketches .....	17-27

PART NO.	QTY. PER PLANE	ENGINE INSTALLATION 65 HP & 85 HP
B-9014	1	Spinner Assy. Complete (Specify Wood or Metal Prop)
BC-A157	1	Engine Mount Assy — 65 HP & 85 HP (Without Starter & Generator)
2551	1	Engine Mount Assy — 85 HP (with Starter & Generator)
AN5-31	4	Bolt — Engine Mount to Fuselage
AN310-5	4	Nut — Engine Mount to Fuselage Bolt
AN6-34	4	Bolt — Engine to Engine Mount
AN310-6	4	Nut — Engine to Engine Mount Bolt
22387	8	Cone — Rubber Shock Mount — Engine to Mount
21530	4	Washer — Engine to Engine Mount
B-610	1	Tube — Oil Breather
B-611	1	Hose — Oil Breather Connector
B-909	2	Clamp — Oil Breather Hose
AN931-10-14	1	Grommet — Oil Breather Tube
D-6138	1	Bracket — Oil Breather Tube
BC-L637	1	Baffle Assy — Complete — 65 HP Engine
BC-L637-2	1	Baffle Assy — Complete — 85 HP Engine

**FOLLOWING ARE REPLACEMENT PARTS FOR BAFFLE ASSY**

BC-A6019	1	Crankcase Baffle
BC-A6020	1	Left Front Outer Baffle
BC-A6021	1	Right Front Outer Baffle
B-A6045	1	Rear Baffle — 65 HP
B-A6045-2	1	Rear Baffle — 85 HP
BC-6169	2	Bottom Inboard Intercyl. Baffle
BC-6170	2	Bottom Outboard Intercyl. Baffle
2131	2	Bent Washer — Outboard Intercyl. Baffle
BC-6242	2	Bracket — Inboard Intercyl. Baffle
BC-6188	2	Rod — Inboard Baffle — Front to Rear
BC-6189	2	Rod — Outboard Baffle — Front to Rear
AN315-3	16	Nut — Rod End
AN960-10	16	Washer — Rod End
AN515-6-64	8	Screw — Outboard Intercyl. Baffle & Inboard Intercyl. Baffle to Bracket & Intercyl. Baffle to Front & Rear
AN515-R6-6	4	Screw — Left & Right Baffles to Rear & Crankcase Baffle
AN365-632	10	Plastic Stop Nut
AN960-6	20	Washer
AN931-10-14	2	Grommet — Baffle Holes for Oil Breather Tube & Ignition Harness

BL-A677	1	Manifold Assy — 1 pc. — 65 HP Lycoming
BC-A6031	1	Manifold Assy — 1 pc. — 65 HP Continental — 65 HP & 85 HP Short Mount
2590-1	1	Manifold Assy — 1 pc. — Continental 85 HP with Starter & Generator — Long Mount
BC-6129	4	Flange for Exhaust Stacks — Replacement
632837	4	Gasket — Continental Manifold Assy
22022	8	Nut — Continental Manifold Assy
BC-L630-85	1	Muff Assy Complete — 85 HP for 2590-1 Manifold Assy

BC-A689	1	Muff Assy Complete — 65 HP for BC-A6031 & BL-A677 Manifold Assy
---------	---	---

**FOLLOWING ARE REPLACEMENT PARTS FOR BC-A689 MUFF ASSY**

B-A690	1	Lower Right Muff Section
B-A691	1	Lower Left Muff Section
B-A692	1	Upper Muff Section
B-6110	6	Heater Muff Clamp
B12-698	2	Heater Muff Clamp
AN515-10-14	6	Screw
AN515-10-18	2	Screw
AN315-3	8	Nut
AN960-10	8	Washer

B-A693	1	Cabin Heater Shut-Off Assy — 65 HP
--------	---	------------------------------------

PART NO.	QTY. PER PLANE	ENGINE INST. CONT'D 65 & 85 HP
0988-6	1	Flexible Metal Tube — 6" x 1½" Dia. (Muff to Cabin Heater)
0988-14	1	Flexible Metal Tube - 9" x 1½" Dia. (Left to Intake to Muff)
0988-17	1	Flexible Metal Tube - 10¼" x 2" Dia. (Right Intake to Muff)
0988-19	1	Flexible Metal Tube - 11½" x 2" Dia. (Muff to Carburetor)
0988-23	1	Flexible Metal Tube - 7½" x 2" Dia. (Airscoop to Muff)
B-669	1	Spring - Carburetor Air Shut-Off
B-6005	1	Bracket — Carburetor Heater Control
<b>ENGINE INSTALLATION—MODEL F19—CONTINENTAL 0-200A</b>		
IB90-CM7443	1	Propeller — McCauley
1A105SCM-69501	1	Propeller — McCauley
2551-12	1	Engine Mount Assy
AN6-44	4	Bolt — Engine to Engine Mount
AN310-6	4	Nut — Engine to Engine Mount
AN5-31	4	Bolt — Engine Mount to Fuselage
AN310-5	4	Nut — Engine Mount to Fuselage
628555-16	4	Rubber Hose — Engine Mounting
530626	8	Seat — Engine Mounting
530627	4	Spacer — Engine Mounting
530740	4	Rubber Bushing — Shock Mounting
530741	8	Cup Washer — Engine Mounting
B-610-1	1	Tube — Oil Breather
B-611-1	1	Hose — Oil Breather Connector
D-6138-1	1	Bracket — Oil Breather Tube

BC-L637-3	1	Baffle Assy Complete
-----------	---	----------------------

**FOLLOWING ARE REPLACEMENT PARTS FOR BC-L637-3**

BC-A6020-1	1	Left Front Outer Baffle
BC-A6021-1	1	Right Front Outer Baffle
B-A6045-4	1	Rear Baffle
BC-6169	2	Bottom Inboard Intercyl. Baffle
BC-6170	2	Bottom Outboard Intercyl. Baffle
2131	2	Bent Washer — Outboard Intercyl. Baffle
BC-6242	2	Bracket — Inboard Baffle Intercyl.
BC-6188	2	Rod — Inboard Baffle — Front to Rear
BC-6189	2	Rod — Outboard Baffle — Front to Rear
AN315-3	16	Nut — Rod End
AN960-10	16	Washer — Rod End
AN515-6-64	8	Screw — Outboard Intercyl. Baffle — Inboard Intercyl. Baffle to Bracket — Intercyl. Baffle to Front & Rear
AN515-R6-6	4	Screw — Left & Right Baffles to Rear Baffle
AN365-632	10	Nut
AN960-6	20	Washer
AN931-10-14	2	Grommet — Baffle Holes for Oil Breather Tube & Ignition Harness

2590-2	1	Manifold Assy — 1 Pc.
BC-6129	4	Flange for Manifold Assy
21493	4	Gaskets — Manifold Assy
22022	8	Nut — Exhaust
BC-L630-6	1	Muff Assy — Right Side — Carburetor Heat
BC-L630-7	1	Muff Assy — Life Side — Cabin Heat
0988-20	1	Flexible Tube — 2" x 11¾"
0988-26	1	Flexible Tube — 2" x 9¼"
0988-31	1	Flexible Tube — 2" x 16¾"
0988-32	1	Flexible Tube — 2" x 24¾"
0988-33	1	Flexible Tube — 1½" x 17¼"
B-A693-2	1	Cabin Heater Shut-Off Assy
B-669	1	Spring — Carburetor Air Shut-Off
21051	1	Gasket — Top of Carburetor
21323	1	Gasket — Air Intake

PART NO.	QTY. PER PLANE	ENGINE INSTLLATION—MODEL F21—LYCOMING 0-235 L2C ENGINE
72CK-0-50	1	Propeller — Sensenich
2800-4	1	Spinner Complete
2801-1	1	Motor Mount — Dynafocal
J7402-24	4	Lord Mounting kit
AN7-34A	4	Bolt — Lord Mounting Kit
AN363-720	4	Nut — Lord Mounting Kit
AN5-31	2	Bolt — Engine Mount to Fuselage — Bottom
AN5-33	2	Bolt — Engine Mount to Fuselage — Top
AN310-5	4	Nut
AN960-516	4	Washer
AN380-2-3	4	Cotter Pin
AN936-A516	2	Star Washer
A-50256	1	Housing — Carburetor Air Intake
B-A4106	1	Filter — Carburetor Air Intake
21051	1	Gasket — Top of Carburetor
AN515-8-12	4	Screw
AN960-8	4	Washer
AN365-832	4	Nut
AN526-8-6	2	Screw
AN936-A8	2	Star Washer
21323	1	Gasket — Air Intake
AN960-416	4	Washer
AN936-A416	4	Washer
AN316-4	4	Nut
2830-4	1	Throttle Bracket
2840-8	1	Throttle Clip
AN3-4A	2	Bolt
AN365-1032	2	Nut
AN960-10	2	Washer
2830-13	1	Bolt — Mixture Control
AN310-4	1	Nut
AN960-416	1	Washer
AN380-2-2	1	Cotter Pin
2830-12	2	Bolt — Carb. Heat & Cabin Heat Control
AN960-10	2	Washer
AN310-3	2	Nut
AN380-2-2	2	Cotter Pin
2830-9	1	Oil Breather Tube
AN931-11-16	1	Grommet
2830-10	1	Oil Breather Hose
2830-11	1	Alt. Cooling Duct
2830-15	1	Air Duct — 2" x 4½"
2830-16	1	Air Duct — 2" x 11½"
2830-17	1	Air Duct — 2" x 11½"
2830-18	1	Air Duct — 1½" x 11½"
	3	5/8" Clamp
	3	½" Clamp
	8	2" Clamp
2835-1L	1	Exhaust Stack — Left Side
2840-1R	1	Exhaust Stack — Right Side
2830-14	2	Spring
2845-1	1	Cabin Heater Muff
2850-1	1	Carburetor Heater Muff
2855-1	1	Cabin Heater Box
AN515-6-6	4	Screw
AN960-6	4	Washer
AN365-632	4	Nut
2860-3 & -4	1	Cooling Box
2860-6	1	2" Flexible Hose 13½"
	1	2" Clamp
2861-1	1	Right Side Baffle
2862-1	1	Left Side Baffle
2863-1	1	Left Front Baffle
2864-1	1	Right Front Baffle
2865-1	1	Right Rear Baffle
2866-1	1	Left Rear Baffle
AN500-416-12	10	Screw
AN515-R6-R6	14	Screw
AN4-6A	1	Bolt
AN365-428	1	Nut
AN931-11-16	2	Grommet
AN960-8	4	Washer
AN960-416	11	Washer
AN935-416	10	Washer

PART NO.	QTY. PER PLANE	ENGINE INST. LYC. CONT'D
AN365-632	4	Nut
<b>COWLING INSTALLATION — 65 HP &amp; 85 HP SHORT MOUNT</b>		
B-9039	1	Hinge — Slip Seam — Center
B-9026	2	Hinge — Slip Seam — Outer
B-9027	2	Clip — Rear & Front Cowl Hinge
B-9061	2	Clip — Lower Cowl Hinge
B-A679 L/R	2	Top Left & Right Cowl Assy (Specify Dzus or Trunk Latch)
B-A681	1	Bottom Cowl Assy (Specify Dzus or Trunk Latch) Pre-War 65 HP Only
B-A681-2	1	Bottom Cowl Assy with 1313-1 Housing (Specify Dzus or Trunk Latch)
1313-1	1	Housing for Air Filter — Replacement
B-A681-5	1	Bottom Cowl Assy (Specify Dzus or Trunk Latch)
BC-A6014	1	Nose Cowl Assy for B-A681 (Less Grills)
BC-A6014-2	1	Nose Cowl Assy for B-A681-2 & B-A681-5 (Less Grills)
B-6074 L/R	2	Cowl Grills — Aluminum — Specify Left or Right
B-1076	1	Firewall
B-1093L/R )	1	Rear Cowl Assy — Soundproofing, Dzus Springs, no cutouts at rear, must be fitted and assembled by customer.
B-1094 )		
<b>COWLING INSTALLATION — 85 HP LONG MOUNT WITH STARTER &amp; GENERATOR</b>		
B-9039-1	1	Hinge — Slip Seam — Center
B-9026-1	2	Hinge — Slip Seam — Outer
B-9027	2	Clip — Rear & Front Cowl Hinge
B-9061	2	Clip — Lower Cowl Hinge
B-A679-1L/R	2	Top Left & Right Cowl Assy (Dzus) Sparkplug Enclosures not included
B-A679-2	2	Sparkplug Enclosures
B-A681-19	1	Bottom Cowl Assy (Dzus)
BC-A6014-2	1	Nose Cowl Assy (Less Grills)
B-6074L/R	2	Cowl Grills — Aluminum — Specify Left or Right
B-1076	1	Firewall
B-1093L/R )	1	Rear Cowl Assy — Soundproofing, Dzus Springs, no cutouts at rear, must be fitted and assembled by customer.
B-1094 )		
<b>COWLING INSTALLATION — MODEL F19 — CONTINENTAL 0-200 A ENGINE</b>		
B-9039-1	1	Hinge — Slip Seam — Center
B-9026-1	2	Hinge — Slip Seam — Outer
B-9027	2	Clip — Rear & Front Cowl Hinge
B-9061	2	Clip — Lower Cowl Hinge
B-A679-1L/R	2	Top Left & Right Cowl Assy — Sparkplug Enclosures not included
B-A679-2	2	Sparkplug Enclosures
B-A681-3	1	Bottom Cowl Assy with 1313-3 Housing
1313-3	1	Housing — Air Filter — Replacement
BC-A6104-1	1	Nose Cowl Assy — Less Grills
B-6074L/R	2	Cowl Grills — Aluminum — State Left or Right
B-1076-2	1	Firewall
B-1093L/R )	1	Rear Cowl Assy — Soundproofing, Dzus Springs, no cutouts at rear, must be fitted and assembled by customer.
B-1094 )		
<b>COWLING INSTALLATION — MODEL F21 — LYCOMING 0-235 L2C ENGINE</b>		
B-9039-1	1	Hinge — Slip Seam — Center
B-9026-2	2	Hinge — Slip Seam — Outer
B-9027	2	Clip — Rear & Front Cowl Hinge
B-9061	2	Clip — Lower Cowl Hinge
2810-1	1	Rear Cowl Assy Complete
2810-6L/R	2	Rear Cowl Sides — Replacement
2810-7	1	Rear Cowl Bottom — Replacement
2810-10	1	Firewall — Replacement
2815-1	1	Bottom Cowl Assy

PART NO.	QTY. PER PLANE	COWLING INSTALLATION MODEL F21—CONT'D.
2820-1	1	Nose Cowl Assy
2825 L/R	2	Top Cowl Assy — Left & Right

NOTE: DZUS FASTENERS INCLUDED WITH ALL COWLING BUT NOT INSTALLED. SLIP SEAM HINGES AND CLIPS INCLUDED WITH COMPLETE TOP COWL.

B-6145	As Req.	Reinforcement for all nose cowl for Dzus Springs — Replacement
B-6166	As Req.	Reinforcement for all bottom cowl for Dzus Springs — Replacement
	100"	½" Webbing — Nose Cowl — Replacement
	82"	½" Webbing — Firewall — Replacement

COWL FASTENERS		
S5A-200	As Req.	Spring — Dzus Fastener
A5-40	As Req.	Screw — Dzus Fastener
AJ5-40	As Req.	Screw — Dzus Fastener — Models F19 & F21 Cowling
GA5-312	As Req.	Grommet — Dzus Fastener
0400-2	4	Fastener — Draw Bolt or Trunk Latch W/Rivets

FUEL SYSTEM INSTALLATION — ENGINE — 65 HP		
2400X3	1	Elbow — Top of Gascolator to Primer
A-902	2	Connector — Gascolator to Carburetor Line
A-946	1	Tee — Main Fuel Line to Gascolator
06096	1	Gasket for Tillotson Gascolator
B-929-1	1	Gascolator Complete — Quick Drain — 2"

FOLLOWING ARE REPLACEMENT PARTS FOR B-929-1

OW-355B	1	Casting — Gascolator Top — Tillotson
OW-352	1	Screen
CCA-1550	1	Quick Drain Valve — ½"
5221	1	Quick Drain — Without Top — Conversion Kit
	1	Glass Bowl
	2	Gasket

AN914-2	1	Elbow — Use With Reducer & Screen at Tank & Fuel Line to Carburetor
B-905	1	Flexible Fuel Line — 12" — Fuel Tank to Gascolator
B-9055	1	Flexible Fuel Line — 8" — Gascolator to Carburetor
AN931-8-20	1	Grommet — Gas Line at Firewall
A-931	1	Primer Jet
B-A39	1	Primer Inlet Line
BC-A319	1	Primer Outlet Line

PARTIAL FUEL SYSTEM INSTALLATION — ENGINE 85 HP

3325X6	1	Fitting — Fuel Line to Tank Valve
3300X6	1	Coupling — Fuel Line to Tank
3400X6	2	90° Elbow — Fuel Line to Gascolator & Carburetor
2576	1	Flexible Fuel Line — 5/16" — Gascolator to Carburetor
2576-1	1	Flexible Fuel Line — 5/16" — Tank to Gascolator

NOTE: PLEASE STATE WHETHER GASCOLATOR IS TO BE MOUNTED ON FIREWALL OR ENGINE MOUNT, AND WHETHER 85 HP INSTALLATION IS FULL ELECTRICAL SO THAT LENGTH OF FUEL LINES MAY BE DETERMINED.

236X6	1	Connector — Fuel Line to Gascolator
94W To 45°	1	Elbow — Fuel Line to Carburetor
B-A39	1	Primer Inlet Line
BC-A319-1	1	Primer Outlet Line

PART NO.	QTY. PER PLANE	PARTIAL FUEL SYSTEM INSTALLATION — ENGINE — MODEL F19 WITH CONTINENTAL 0-200A ENGINE
2577-1	1	Flexible Fuel Line — Gascolator to Carburetor
2577-2	1	Flexible Fuel Line — Gas Tank to Gascolator
AN931-16-22	1	Grommet — Gas Line at Firewall
DG-16	1	Clamp
DG-12	1	Clamp
AN515-6-12	1	Screw to Secure Clamps
AN960-6	1	Washer
AN365-632	1	Nut
3400X6	2	90° Elbow — Fuel Line to Gascolator & Carburetor
3325X6	1	Fitting — Fuel Line to Tank Valve
3300X6	1	Coupling — Fuel Line to Tank
1012-6-6S	3	Male Connector — Fuel Line to Gascolator Inlet & Outlet & Fuel Line to Tank
1012-4-6S	1	45° Elbow — Fuel Line to Carburetor
B-A39	1	Primer Inlet Line
BC-A319-1	1	Primer Outlet Line

PARTIAL FUEL SYSTEM INSTALLATION — ENGINE — MODEL F21 WITH LYCOMING 0-235 L2C ENGINE

2577-2	1	Flexible Fuel Line — Gas Tank to Gascolator
2577-3	1	Flexible Fuel Line — Gascolator to Carburetor
AN931-16-22	1	Grommet — Gas Line at Firewall
1012-4-6S	1	45° Elbow — Fuel Filter Outlet
AN912-2	1	Bushing for 1012-4-6S
6FTXB	1	Connector — Fuel Line to Carburetor
3400X6	2	90° Elbow — Fuel Line to Gascolator & Carburetor
3325X6	1	Fitting — Fuel Line to Tank Valve
3300X6	1	Coupling — Fuel Line to Tank
1012-6-6S	2	Male Connector — Fuel Line to Gascolator Outlet
C10P	2	Clamp — ¾"
C24P	2	Clamp — 1¼"
B-A39	1	Primer Inlet Line
BC-A319-2	1	Primer Outlet Line

FUEL SYSTEM INSTALLATION — ENGINE — MODELS F19, F21, & 85 HP

2581	1	Gascolator Complete — 2½"
	1	Mounting Kit for Gascolator on Firewall

FOLLOWING ARE REPLACEMENT PARTS FOR 2581

2580	1	Casting — Top
	1	2½" Quick Drain — Conversion Kit
	1	2½" Glass Bowl
	1	2½" Screen
	2	2½" Gasket

PARTIAL FUEL SYSTEM INSTALLATION — FUSELAGE — 65 HP

B-A38-1	1	Cap & Fuel Gauge — (Cork, Wire & Cap)
1006	1	Gasket — Replacement
0797	1	Tank — 12 Gallon — (Cap not included)
B-A301	1	Elbow & Screen Assy
B-A305	1	Valve — Fuel Shut-Off ¼"
B-669	1	Spring — Fuel Shut-Off Assist
B12-901	1	Reducer — ¼ to ½

PARTIAL FUEL SYSTEM INSTALLATION — FUSELAGE — 85 HP, MODEL F19, MODEL F21

0797-12	1	Tank — 12 Gallon
0797-9	1	Gas Gauge Base — Replacement — Welds on 0797-12
6560-12	1	Fuel Gauge — 85 HP
6560-46	1	Fuel Gauge — Models F19 & F21
AN503-416-12	4	Screws to Mount Gauge
B-A305-2	1	Valve — Fuel Shut-Off — ¾"
B-A301-1	1	Elbow & Screen Assy

PART NO.	QTY. PER PLANE	FUEL SYSTEM INST. — FUSELAGE — 85 HP, MODEL F19, MODEL F21 CONT'D.
B12-L108-8	1	Vent Line — Lower
B12-L108-10	1	Vent Line — Upper
A-306	1	Sealed Gas Cap for Fuselage Tank Filler Neck

**FUEL SYSTEM INSTALLATION — FUSELAGE — ALL MODELS**

0400-90	1	Grommet — Tank Filler Neck to Rear Cowling
B12-104	2	Rod — Tank Support Tie Rods
B-669	1	Spring — Fuel Shut-Off Assist
B12-947-3	1	Clip — Fuel Shut-Off Control
B-A116	4	Rubber Shock Mounts for Tank
D-956	1	Tee — Aux. Fuel Line to Rear of Main Tank

**FUEL SYSTEM INSTALLATION — WING — ALL MODELS EXCEPT AS NOTED**

B12-A37	2	Wing Tank Cap
B12-A37-3	2	Wing Tank Cap — 85 HP Only
1006	2	Gasket — Replacement
B12-312	2	Ring — Cap Fairing
1546-1L/R	2	Tank — 6 Gallon — State Left or Right — Cap not included
D-3000-1	4	Strap — Wing Tank Support — (Screws, Nuts & Felt included)
AN515-8-32	4	Screw — Replacement
AN365-832	4	Nut — Replacement
1756-1	2	Felt Pad — Tank Filler Neck
1756-2	4	Felt Pad — Tank Filler Neck
B12-300	8	Felt — Nails onto Spar
B12-39	4	Felt — Glues under Lip of Tank
B12-A31-1	2	Fuel Line — Aux. Tank to Main Tank — 5 1/8" (for valve installation at wing butt)
B-967	2	Aux. Fuel Shut-Off Valve
B12-901	1	Reducer — 1/4 to 3/8
D-956	1	Tee — Aux. Fuel Line to Rear of Main Tank
B12-L30-14	2	Tube Assy — 7 1/2"
D-933	4	Connector — Fuel Line
AN910-2D	2	Coupling
B12-9139	2	Elbow with 5/16" Hole
B12-L30-9	2	Tube Assy — 4 1/2"
B12-L30-5	2	Connector with Strainer
B12-L30	Rev. AE	Print for Wing Tank Installation

**INSTRUMENT & ENGINE CONTROLS FOR ALL MODELS**

D-941	1	Primer
B12-9085	1	Knob — Gas Shut-Off
B12-947-3	1	Clip — Fuel Shut-Off Control — Complies with AD Note
B12-9127	1	Bushing — Gas Shut-Off Control
B12-A62	1	Rod — Gas Shut-Off Control
B-A706	1	Line — Oil Pressure Gauge to Engine
B-7071	1	Connector — Oil Pressure Line to Engine
3350X2	1	45° Elbow
AN931-4-7	1	Grommet — Oil Pressure Line at Firewall
A-98	1	Clamp — Oil Pressure Line to Connector
0993-1L/R	2	Door Assy — Glove Compartment
0989-1	2	Glove Compartment
B12-A772	2	Tube — Fuselage Section — Airspeed
A-745	2	Rubber Host Connector for B12-A772
0896	1	Instrument Panel - 1945 & Later Only — Un-painted
0896-1	1	Instrument Panel — 1945 & Later Only — Painted with Black Crackle Finish
A-245	As Req.	Fibre Bushing — 5/16"

NOTE: Can no longer furnish original style instrument panel with recesses at upper corners. The above are flat panels only. State with or without glove compartment holes, or blanks.

**INSTRUMENT & ENGINE CONTROLS — 65 HP & 85 HP**

10-35729-1	1	Magneto Switch with Lock
B12-9089	1	Carburetor Heat Control

PART NO.	QTY. PER PLANE	INSTRUMENT & ENGINE CONTROLS — 65 HP & 85 HP CONT'D.
B-6005	1	Bracket — Carb. Air Intake Control
AN931-4-7	1	Grommet — Carb. Heat Control
B12-9102	1	Throttle Control — All B Models & 85 HP Short Mount
BC-6209	1	Bracket — Throttle Control
AN931-4-16	1	Grommet — Throttle Control
B12-9117	1	Mixture Control
B12-9118	1	Cabin Heat Control
2550	1	Oil Pressure Gauge - 0-100
2657	1	Oil Pressure Gauge with Taylorcraft Logo-Red Line (Max.) 100 PSI (Min.) 10 PSI Green Arc (Normal Operation 30-60 PSI)
2658	1	Oil Temperature Gauge with Taylorcraft Logo Red Line (Max. 240° F. Min. 100° F.) Green Arc (Normal Operation 100° F - 240° F)
3010-3	1	Ammeter — 30-0-30
C2300	1	Compass — Overhead
	1	Bracket for C2300 Compass including hardware
C2400 L4P	1	Compass — Pedestal — Mounts on Deck Panel
B-A755	1	Tach Shaft & Housing Complete — for Old Style Stewart Warner Tach — Original Equipment
B-9131-1	1	Core — Tach Drive — Replacement for above
B-9134	1	Housing — Tach Drive — Replacement for above
RT-10	1	AC Tachourmeter — 65 HP — Counterclockwise
411335	1	90° Reverse Angle Drive
407010	1	90° Right Angle Drive
B-A755-1	1	Tach Shaft & Housing Complete — for AC Tach
B-9131-1	1	Core — Tach Drive — Replacement for above
B-9134-1	1	Housing — Tach Drive — Replacement for above
AN931-10-14	1	Grommet — Tach Cable

NOTE: TACH SHAFT & HOUSING MUST BE REPLACED WHEN ORDERING AC TACH

0979-1	1	Deck Panel — BC12D
		<b>PARTIAL INSTRUMENT &amp; ENGINE CONTROLS — MODEL F19</b>
10-357200-1	1	Magneto Switch with Lock, Starter, Switch & Dial
B12-9089	1	Carburetor Heat Control
B12-947-3	1	Clip — Carb. Heat Control
AN931-4-7	1	Grommet — Carb. Heat Control
B12-9102-1	1	Throttle Control
AN931-4-16	1	Grommet — Throttle Control
2633	1	Bracket — Throttle Control
2635	2	Clamp — Throttle Control Bracket
B12-9117	1	Mixture Control
2634	1	Bracket — Mixture Control
B12-9118	1	Cabin Heat Control
2657	1	Oil Pressure Gauge with Taylorcraft Logo-Red Line (Max.) 100 PSI (Min.) 10 PSI Green Arc (Normal Operation 30-60PSI)
2658	1	Oil Temperature Gauge with Taylorcraft Logo Red Line (Max. 240° F Min. 100° F.) Green Arc (Normal Operation 100° F - 240° F)
3010-4	1	Ammeter - 60-0-60
0400-82-1	1	Sensitive Altimeter
0400-83-1	1	Airspeed — Green Arc 45-108, Yellow Arc 108-136, Red Line 136 MPH
C2400 L4P	1	Compass — Pedestal — Mounts on Deck Panel
RT-11	1	Tachourmeter — Clockwise
DA-10	1	90° Right Angle Drive
B-A755-1	1	Tach Shaft & Housing Complete.
B-9131-1	1	Core — Tach Drive — Replacement
B-9134-1	1	Housing — Tach Drive — Replacement
AN931-10-14	1	Grommet — Tach Cable
2639	1	Deck Panel

**PARTIAL INSTRUMENT & ENGINE CONTROLS — MODEL F21**

10-357200-1	1	Magneto Switch with Lock Starter, Switch & Dial
B12-9089-3	1	Carburetor Heat Control
B12-947-3	1	Clip — Carburetor Heat Control
AN931-4-7	1	Grommet — Carburetor Heat Control

PART NO.	QTY. PER PLANE	PARTIAL INSTRUMENT & ENGINE CONTROLS — MODEL F21 CONT'D.
B12-9102-3	1	Throttle Control
2830-4	1	Throttle Bracket
2830-8	1	Throttle Clip
AN3-4A	2	Bolt
AN365-1032	2	Nut
AN960-10	2	Washer
B12-9117-3	1	Mixture Control
2830-13	1	Bolt — Mixture Control
AN310-4	1	Nut
AN960-416	1	Washer
AN380-2-2	1	Cotter Pin
B12-9118-3	1	Cabin Heat Control
2830-12	2	Bolt — Carburetor Heat & Cabin Heat Control
AN960-10	2	Washer
AN310-3	2	Nut
AN380-2-2	2	Cotter Pin
2691	1	Oil Temperature Gauge with Sender (Electric)
2692	1	Oil Pressure Gauge
3010-4	1	Ammeter — 60-0-60
0400-82-1	1	Sensitive Altimeter
0400-83-1	1	Airspeed — Green Arc 45-108, Yellow Arc 108-136, Red Line 136 MPH
C2400 L4P	1	Compass — Pedestal — Mounts on Deck Panel
RT-11	1	Tachometer — Clockwise
DA-10	1	90° Right Angle Drive
B-9131-2	1	Core — Tachourmeter Drive
B-9134-2	1	Housing — Tachourmeter Drive
B-9131-3	1	Core — Tachourmeter Drive — Full Gyro Panel
B-9134-3	1	Housing — Tachourmeter Drive — Full Gyro Panel
AN931-10-14	1	Grommet — Tach Cable
2639	1	Deck Panel
<b>FLIGHT CONTROL</b>		
1325-1	2	Control Wheel — Magnesium Cast (Started with 1946 Models — Interchangeable)
1394-2	2	Control Wheel Shaft
AN23-22A	2	Bolt
1394-3	2	Control Wheel Cover — For Mag. Cast Wheel Only
1394-4	2	Taylorcraft Emblem — Control Wheel Cover
A-249	2	Guide — Control Wheel Shaft — Fibre
A-250	4	Rubber Channel for A-249
A-251	4	Rubber Channel for A-249
AN515-6-40	4	Screw
AN365-632	4	Stop Nut
A-230-1	1	Sprocket — Right Aileron Control
A-903	1	Woodruff Key
AN320-8	1	Nut
AN380-3-3	1	Cotter Pin
A-A231	1	Sprocket — Left Aileron Control
A-903	1	Woodruff Key
AN320-8	1	Nut
AN380-3-3	1	Cotter Pin
B-223	2	Chain at Sprocket
A-247	1	Master Chain Link for B-223
A-228	10	Pulley — Control Cable 3" Dia. (Less Bushing)
A-229	8	Pulley — Control Cable 1 3/4" Dia. (Less Bushing)
A-920	18	Bushing for A-228 & A-229 Pulley
AN3-7	4	Bolt
AN3-6	10	Bolt
AN3-15	1	Bolt
AN380-2-2	15	Cotter Pin
AN320-3	15	Shear Nut
B-A104	2	Bracket Assy — Aileron Pulley
B-27	2	Bearing Housing — to Mount Control Column
B-224	As Req.	Shim
AN3-4	4	Bolt
AN310-4	4	Nut
AN960-10	4	Washer
AN380-2-2	4	Cotter Pin
B-901-1	2	Rubber Bumper — Control Column — Forward Sect.

PART NO.	QTY. PER PLANE	FLIGHT CONTROL CONT'D
AN515-6-16	2	Screw
AN960-6	2	Washer
AN340-6	2	Nut
A-A27-1	2	Universal — Complete Assy
<b>FOLLOWING ARE REPLACEMENT PARTS FOR A-A27-1</b>		
A-29	2	Center Block
B-A216	2	Front Shaft
B-A217	2	Hub Assy
AN3-14	4	Bolt
AN310-3	4	Nut
AN960-10	4	Washer
AN380-2-2	4	Cotter Pin
B-A20R	1	Bar — Right Rudder Pedal — Mechanical Brakes
B-A21L	1	Bar — Left Rudder Pedal — Mechanical Brakes
B-A20-2	1	Bar — Right Rudder Pedal — Hydraulic Brakes
B-A21-2	1	Bar — Left Rudder Pedal — Hydraulic Brakes
AN3-10A	2	Bolt
AN3-4A	8	Bolt
AN365-1032	10	Nut
AN960-10	8	Washer
AN960-10L	8	Washer
B-A107	1	Spring Assy — Rudder Pedal Return
A-246	2	Springs — Rudder Pedal Return
A-1088	2	Bushing — Rudder Pedal Bar Clamp
A-1089	2	Bushing — Rudder Pedal Bar Clamp
B12-A21	1	Cable Assy — Aileron Control (Consists of (2) B12-A22, (1) B-A203-1, (2) B-223 & A-247)
B12-A22	2	Cable Assy — Aileron Control
B-A203-1	1	Cable Assy — Aileron Control
B-A26-1	1	Cable Assy — Right Rudder
B-A27-1	1	Cable Assy — Left Rudder
D-26	2	Link Connector
A-245	2	Bushing — Fibre — Rudder Control
AN3-6	2	Bolt
AN320-3	2	Nut
AN380-2-2	2	Cotter Pin
A-146	14	Bushing — Cable Fairleads (Round — Glue In)
B-154	2	Guide — Rudder Cable Fairlead — Left Side
B-155	2	Guide — 3 Cable Fairlead — Right Side
AN3-7	8	Bolt
AN320-3	8	Nut
AN380-2-2	8	Cotter Pin
B-A28-1	1	Cable Assy — Elevator Top
B-A29-1	1	Cable Assy — Elevator Bottom — Use with small pulley
AN3-6	2	Bolt
AN320-3	2	Nut
AN380-2-2	2	Cotter Pin
AN130-16S		Turnbuckle Assy — 4 1/2" Cable Eye, Barrel & Fork Eye
AN140-16S		Turnbuckle Assy — 4 1/2" (2) Cable Eye, Barrel
AN100-3		Thimble — 1/16
AN100-4		Thimble — 3/32, 1/8
AN111-4		Bushing
		1/16 Nico Press Sleeve
		1/8 Nico Press Sleeve
		3/32 Nico Press Sleeve
<b>PLACARDS</b>		
B-7030	1	Placard (When Removing Controls, Etc.)
B12-307-1**	As Req.	Placard (Refill Main Tank in Level Flight, etc.)
D-766	1	Placard (Do Not Exceed 140 MPH)
D-766-1	1	Placard (Do Not Exceed 136 MPH) Models F19 & F21
B12-928	1	Placard (Trim Tab Position Indicator)
B12-790	1	Placard (Baggage Compartment)
B-9086	1	Manufacturers Plate (Blank)
2650	1	Manufacturers Plate (Blank) Models F19 & F21

PART NO.	QTY. PER PLANE	PLACARDS CONT'D.
1179	2	Taylorcraft Decal (Mix detergent and water and apply to plane before positioning the decal. This allows for movement of decal to position properly)
0894-4	2	Aux. Wing Tank — Useable Fuel 6 Gal.
0894-5	1	Operational — Models F19 & F21
0894-8	1	Main Tank — Useable Fuel 9 Gal. — Models F19 & F21
Misc. Placards on Self-Adhesive Sheet		Nav. Lights, Parking Brake, Master Switch — Off-On, T-Craft, Turn Off Anti-Coll., etc., Anti-Coll., ADF, Transponder, Clock, Turn & Bank, Inter-Com., Radio, Radio On, Mike, Headset, Landing Light, Dome, Compass Cal.

**\*\*NOTE: BULLETIN SEPT. 15, 1970 — THIS PLACARD NOW READS "REFILL MAIN TANK IN LEVEL FLIGHT AND ONLY WHEN MAIN TANK IS LESS THAN HALF FULL," AND MUST REPLACE OLD PLACARD.**

ELECTRICAL SYSTEM		
S25	1	Battery — 12 Volt
2596	1	Battery Box for S25 Battery (State where to be installed)
A-2064-12	1	Tail Light — Clear — Grimes Type "S" (Bulb Included)
MS35478-93	1	Bulb — Replacement
W1285-PR	1	Left Wing Light — Red — Whelen (Bulb Included)
W1285-PG	1	Right Wing Light — Green — Whelen (Bulb Included)
W-1290-14	2	Bulb — Replacement
W-1282	2	Lens Retainer — Replacement
W1284-G or-R	2	Lens — Red or Green — Replacement
W1283	2	Gasket — Replacement
W1285-2	2	Light Base — Replacement
Wing Tip Strobe Kit — Complete with (2) Power Packs, Wiring, Switches, Strobe Head Assy, Etc. — Approved on Model F21.		
A-650-PR	1	Strobe Head Assy — Left Wing
A-650-PG	1	Strobe Head Assy — Right Wing
A-610	2	Flash Tube Assy — Replacement
A-626	2	Retainer Lens — Replacement
A-612	2	Magnifying Lens — Replacement
A490T-DF-14	2	Power Packs
3302-1	1	Whelen Tail Strobe Kit — Complete with (1) Power Pack, Strobe Assy, Wiring, Clamps, etc. Installs on Top of Fin
A-470	1	Tail Strobe Assy
A-402-W	1	White Optic Lens — Replacement
A-409	1	Clamp Ring Assy — Replacement
A-467	1	Gasket — Replacement
A-465	1	Spring — Replacement
A-469A	1	Flash Tube Assy — Replacement
A490T-DF-14	1	Power Pack

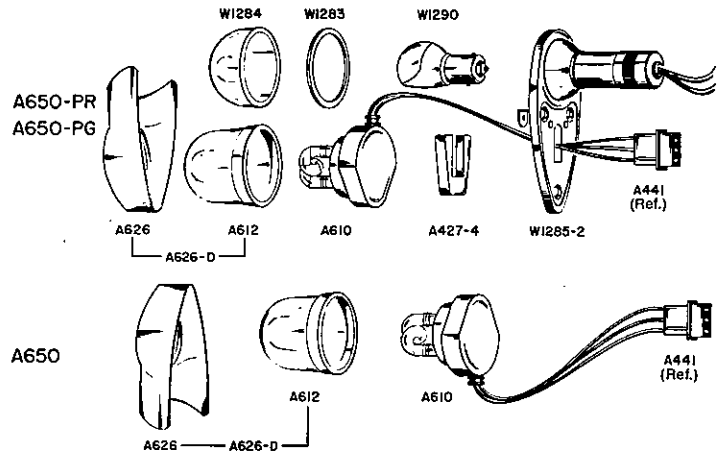
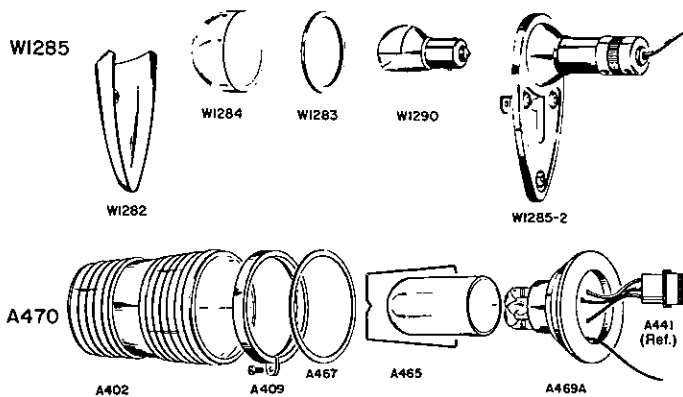

PART NO.	QTY. PER PLANE	ELECTRICAL SYSTEM CONT'D
2615-1	1	Landing Light Kit Complete — Installs in Left Wing
2595-51	1	Cabin Light Kit Complete — Installs in Dome
A-2200	1	Cabin Light Only
1381-1	2	Wire — Nav. Light — Wing
1417-1	1	Wire — Nav. Light — Tail
2595-27	1	Wire — Nav. Light — Across Cabin
2595-28	1	Wire — Nav. Light — Left Front Wing Butt to Instrument Panel
8396K8	1	Switch — Nav. Light
S6-4800	1	Wire — Right Mag. to Switch (Unshielded)
S6-4020	1	Wire — Left Mag. to Switch (Unshielded)
1565-3	1	Wire — Right Mag. to Switch (Shielded)
1565-4	1	Wire — Left Mg. to Switch (Shielded)
AN931-3-5	1	Grommet — Ignition Wire
4204	1	Solenoid — Installs on Firewall
8781-1	1	Battery Relay — Installs on Battery Box
MS35059-22	1	Master Switch
3AG	As Req.	Fuseholder

#### ALIGHTING GEAR INSTALLATION

Tapered Axle Landing Gears are no longer available		
2582-3 L/R	2	Vee Assy — Left or Right Uncovered — Straight Axle
2582 L/R	2	Vee Assy — Left or Right Covered thru Silver
B-A51 L/R	2	L/G Tie Strut — State L or R — Replacement
AN320-12	2	Axle Nut — Tapered Axle
2680	2	Axle Nut — Straight Axle — Replacement
B-901	2	Rubber Bumper

**NOTE: FOR INSTALLATION OF B-901 BUMPER, (1) APPLY ADHESIVE (SCOTCH-GRIP 847 OR EQUIV.) AND ATTACH BUMPER EXACTLY IN LINE WITH SHOCK TRUSS. (2) LOCATE HOLES WITH AWL IN SHOCK TRUSS AND ATTACH BUMPER WITH (8) AN970-3 WASHER AND (8) 4 x 3/8 PK SCREW. GRIND OFF ONE SIDE OF (4) WASHERS. INSTALL ON AFT SIDE OF SHOCK TRUSS, CUT SIDE DOWN, TO PREVENT CHAFING OF SHOCK CORDS.**

A-520	4	Bushing — L/G Vee at Fuselage
B12-943	2	Bushing — L/G Tie Strut
	1	Landing Gear Bolt Kit — (2) AN5-17, (4) AN5-21, (6) AN310-5
B12-52	2	Cable — L/G Safety Stop
A-A754-1 L/R	2	L/G to Fuselage Fairing — State L or R
A-A11	2	Rear L/G and Wing Strut Fitting — Welds on Fuselage
A-A123	2	Front L/G Fitting — Welds on Fuselage
	1	Easy-On Shock Cord Tool
9090	4	Shock Cord — Pre-War Models up to Year 1942
9010	4	Shock Cord — 1945 BC12D and Later
9010 HDX	4	Shock Cord — Extra Heavy Duty — 1945 BC12D and Later
B-772 L/R	2	Fairing — Shock Cord Cover — State L or R



PART NO.	QTY. PER PLANE	ALIGHTING GEAR CONT'D
A-A140 L/R	2	Step — State L or R
A-92	2	Tire — 6:00 x 6 — 6 Ply
A-93	2	Tube

FOLLOWING PARTS ARE FOR TAPERED AXLE LANDING GEARS ONLY — PARTS NOT LISTED ARE NO LONGER AVAILABLE.

A-572 L/R	2	Rod — Connector Link — Bellcrank to Brake — State L or R
A-576	2	Rod — Bellcrank Hinge Pin
B-A57 L/R	2	Bellcrank — Brake Control — State L or R
A-5010 L/R	2	Brake Release Spring — State L or R
6CA3	1	Brake Dust Shield — Right
6CA4	1	Brake Dust Shield — Left
AN507-10-8	14	Flat Heat Machine Screw
6CA12	4	Brake Shoe — Metal
6CA28	2	Cam Arm
6CA51	1	Half Wheel — Inner
6CP27	6	Bolt
6CP34	2	Outboard Retainer
6CP35	2	Inboard Retainer
6CP44	4	Shoe Adjusting Nut
6CP45	4	Clip — Adj. Nut Lock Spring
6CP46	4	Shoe Adjusting Wedge
6CP47	4	Shoe Adjusting Bolt
6CP51	2	Brake Lining with Rivets — Rivets to Inner Wheel Half
6CP63	4	Brake Shoe Spring
6CP65	2	Cam Arm Link
6CP75	2	Washer
6CP94	4	Washer
6CP95	4	Cotter Pin
A-500	2	Washer
08125	2	Wheel Bearing — 1 1/4"
08231	2	Inner Race
A-6075	2	Wheel Bearing — 3/4" <i>11.01</i>
A-6162	2	Outer Race <i>5.70</i>
6CP143	6	Round Head Machine Screw — Hub Cap
6CP144	6	Nut — Hub Cap

FOLLOWING PARTS ARE FOR STRAIGHT AXLE LANDING GEAR WITH CLEVELAND MECHANICAL WHEELS & BRAKES

030-00301 (30-3A)	2	Cleveland Brake Assy Complete
066-00500	4	Brake Lining
089-00200 L/R	4	Plate — Wear (1) LH (1) RH on ea. brake assy
105-00300	12	Rivet
AN4-15A	2	Bolt
AN960-416	2	Washer
AN365-428	2	Nut
093-00200	2	Plate — Anchor Bolt
181-00100	2	Cam — Brake
082-00400	2	Spring
AN4H-5A	8	Special Bolt — Torque Plate to Axle Washer

FIG	OLD PART NUMBER	PART NUMBER	DESCRIPTION	ASSEMBLY NUMBER	QTY. PER ASSY.	
					30-3	30-3A
1	65-8	065-00800	Plate-Torque		1	1
2	172-2B	172-00202	Shoe Assy.		1	1
	139-46B	139-04602	Shoe Subassy.		1	1
	66-5	066-00500	Lining		1	1
	145-3	145-00300	Bushing		1	1
	105-3	105-00300	Rivet		6	6
3	89-2	089-00200	Plate-Wear		1	1
	172-2A	172-00201	Shoe Assy.		1	1
	139-46A	139-04601	Shoe Subassy.		1	1
4	66-5	066-00500	Lining		1	1
	145-3	145-00300	Bushing		1	1
	105-3	105-00300	Rivet		6	6
	89-2	089-00200	Plate-Wear		1	1
5	174-1	174-00100	Pulley-Bracket Assy.		1	1
6	179-1	179-00100	Pulley Cable		1	1
7	173-1	173-00100	Bracket Pulley		1	1
8	145-4	145-00400	Bushing		1	1
9	145-5	145-00500	Bushing		1	1

FIG	OLD PART NUMBER	PART NUMBER	DESCRIPTION	ASSEMBLY NUMBER	QTY. PER ASSY.	
					30-3	30-3A
10	AN3-7A	103-00200	Bolt		1	
11	AN365-1032	094-10200	Nut		1	
12	AN4-23A	103-10600	Bolt		1	
13	AN4-15A	103-10400	Bolt		1	2
14	AN960-416	095-10400	Washer		3	2
15	AN365-428	094-10300	Nut		2	2
16	93-2	093-00200	Plate-Anchor Bolt		2	2
17	181-1	181-00100	Cam. Assy.		1	1
	175-1	175-00100	Cam-Brake		1	1
	177-1	177-00100	Pin-Brake		1	1
	178-1	178-00100	Lever-Cam		1	1
18	176-2	176-00200	Clip-Washer		1	1
19	176-1	176-00100	Clip-Washer		1	1
20	AN3-5A	103-00100	Bolt		1	1
	AN365-1032	094-10200	Nut		1	1
21	82-3	082-00300	Spring		1	1
22	82-4	082-00400	Spring		1	1
23	AN526-1024-8	102-25100	Screw		1	1
24	95-2	095-00200	Washer		1	1
25	145-6	145-00600	Bushing		1	1

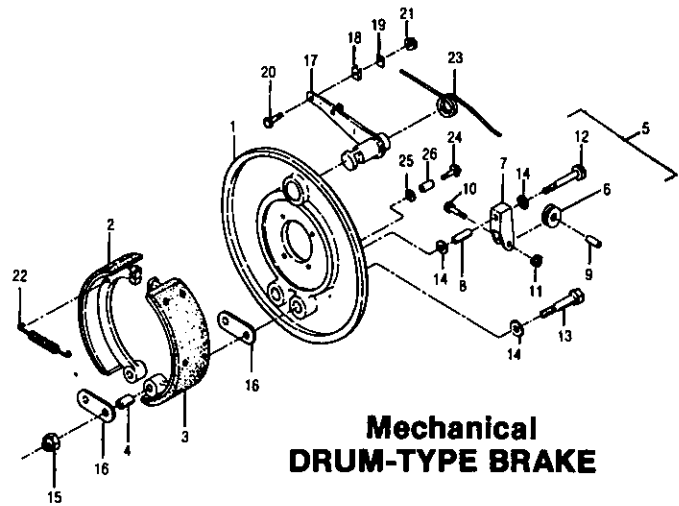

**Mechanical DRUM-TYPE BRAKE**

PART NO.	QTY. PER PLANE	ALIGHTING GEAR CONT'D
040-00700 (40-7) 2	2	Wheel Assembly Complete
153-00500	4	Ring — Grease Seal — Use with Wheel Pants Only
153-00300	2	Ring — Grease Seal
154-00500	2	Felt — Grease Seal
157-00200	2	Dust Shield
158-00200	2	Hub Cap
067-00300	2	Spacer
214-00100	2	Cup Bearing
214-00200	2	Cone Bearing

**Cleveland Wheels & Brakes**



(1) For Brake Drum Assy. Replacement Part order 169-00101

(2) For Brake Drum Assy. Replacement Part order 169-00201 (Use Tube-Tire only)

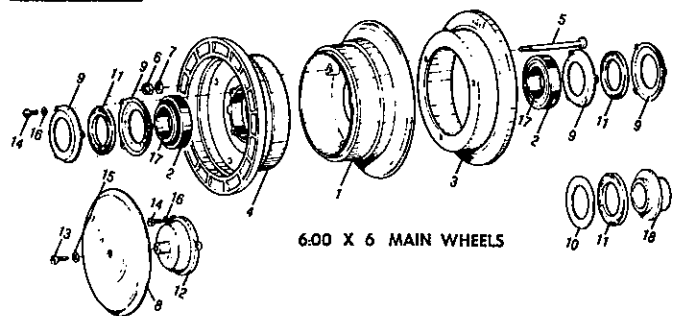

**6.00 X 6 MAIN WHEELS**

FIG	OLD PART NUMBER	PART NUMBER	DESCRIPTION	ASSEMBLY NUMBER	QTY. PER ASSY.		
					40-6(1)	40-7(2)	40-7A(2)
1	161-6	161-00600	Inner Wheel Half Assy	1			
	161-7	161-00700	Inner Wheel Half Assy		1	1	
2	13836	214-00100	Cup-Bearing	1	1	1	
3	169-1	169-00100	Brake Drum Assy.	1			
	169-2	169-00200	Brake Drum Assy.		1	1	
4	162-6	162-00600	Outer Wheel Half Assy	1	1	1	
2	13836	214-00100	Cup-Bearing	1	1	1	
5	AN4-36A	103-11000	Bolt	3	3	3	
6	AN365-428	094-10300	Nut	3	3	3	
7	AN960-416	095-10400	Washer	3	3	3	
8	157-2	157-00200	Shield-Dust	1	1		
9	153-5	153-00500	Ring-Grease Seal	2		4	
10	153-3	153-00300	Ring-Grease Seal		1		
11	154-4	154-00400	Felt-Grease Seal	1		2	
	154-5	154-00500	Felt-Grease Seal		1		
12	158-10	158-01000	Cap-Hub	1			
	158-2	158-00200	Cap-Hub		1		
13	AN526-1024-8	102-25100	Screw	1	1		
14	AN500-8-8	102-05100	Screw	6	3	6	
15	AN936-A10	095-15400	Lock-Washer	1	1		
16	1208	095-15100	Lock-Washer	6	3	6	
17	13889	214-00200	Cone Bearing	2	2	2	
18	67-3	067-00300	Spacer-Inner Shldr.	1			

**QTY. PART PER NO. PLANE** HYDRAULIC BRAKE SYSTEM — MODEL F21  
**030-05500 2** Brake Assy Complete  
 (30-55)

FIG	OLD PART NUMBER	PART NUMBER	DESCRIPTION	ASSEMBLY	QTY. PER ASSY.												
					30-56	30-56A	30-56B	30-63	30-63A	30-63B	30-63C	30-63D	30-63E	30-63F	30-63M	30-63P	30-63Q
	31-22	091-02200	Cylinder Assy.		1	1	1	1	1	1	1	1	1	1	1	1	
	91-39	091-03900	Cylinder Assy.														
	91-50	091-05000	Cylinder Assy.														
	91-84	091-08400	Cylinder Assy.														
	91-119	091-11900	Cylinder Assy.														
	91-122	091-12200	Cylinder Assy.														
1	61-19	061-01900	Cylinder	1	1	1	1	1	1	1	1	1	1	1	1	1	
	92-17	092-01700	Piston Assy.														
2	62-16	062-01600	Piston	1	1	1	1	1	1	1	1	1	1	1	1	1	
3	AN6230-2	101-05200	"O" Ring	1	1	1	1	1	1	1	1	1	1	1	1	1	
	73-11	073-01100	Pressure Plate Assy.														
	73-36	073-03600	Pressure Plate Assy.														
4	63-12	063-01200	Plate-Pressure	1	1	1	1	1	1	1	1	1	1	1	1	1	
5	66-30	066-03000	Lining	1	1	1	1	1	1	1	1	1	1	1	1	1	
	66-55	066-05500	Lining														
6	561	105-00200	Rivet	2	2	2	2	2	2	2	2	2	2	2	2	2	
	74-10	074-01000	Back Plate Assy.														
	74-29	074-02900	Back Plate Assy.														
7	64-15	064-01500	Plate-Back	1	1	1	1	1	1	1	1	1	1	1	1	1	
	66-30	066-03000	Lining														
	66-55	066-05500	Lining														
	561	105-00200	Rivet	2	2	2	2	2	2	2	2	2	2	2	2	2	
8	69-4	069-00400	Bolt-Anchor	2	2	2	2	2	2	2	2	2	2	2	2	2	
9	AN365-428	094-10300	Nut	2	2	2	2	2	2	2	2	2	2	2	2	2	
10	AN960-416L	095-10200	Washer	4	4	4	4	4	4	4	4	4	4	4	4	4	
11	81-1	081-00100	Seat-Bleeder	1	1	1	1	1	1	1	1	1	1	1	1	1	
12	79-3	079-00300	Screw-Bleeder	1	1	1	1	1	1	1	1	1	1	1	1	1	
13	183-1	183-00100	Cap-Bleeder	1	1	1	1	1	1	1	1	1	1	1	1	1	
14	AN816-4D	104-00300	Fitting-Tube														
	AN822-4D	104-00400	Fitting-Tube														
15	AN823-4D	104-00500	Fitting-Tube	1	1	1	1	1	1	1	1	1	1	1	1	1	
	LP4-17AM	103-11500	Bolt-Lock	2	2	2	2	2	2	2	2	2	2	2	2	2	
	AN4H-17A	103-12300	Bolt-Lock														
16	75-31	075-03100	Torque Plate Assy.	1	1	1	1	1	1	1	1	1	1	1	1	1	
	75-16	075-01600	Torque Plate Assy.														
	75-37	075-03700	Torque Plate Assy.														
	75-52	075-05200	Torque Plate Assy.														
	75-56	075-05600	Torque Plate Assy.														
	75-74	075-07400	Torque Plate Assy.														
	75-77	075-07700	Torque Plate Assy.														
	75-94	075-09400	Torque Plate Assy.														
	75-140	075-14000	Torque Plate Assy.														

**Organic Lining**

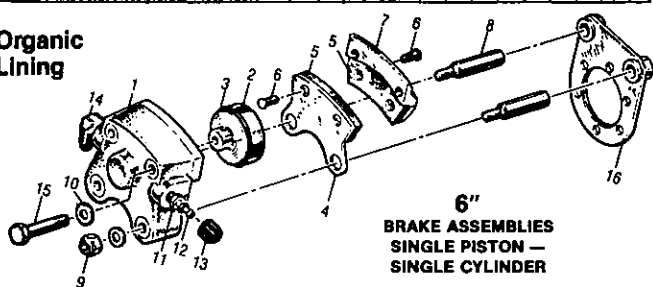

**QTY. PART PER NO. PLANE** HYDRAULIC BRAKE SYSTEM CONT'D.  
**040-08600 2** Wheel Assy Complete  
 (40-86)

FIG	OLD PART NUMBER	PART NUMBER	DESCRIPTION	ASSEMBLY NUMBER	QTY. PER ASSY.			
					40-86(1)	40-86A(1)	40-86B(1)	40-41
1	161-30	161-03000	Inner Wheel Half Assy.	1	1			1
	161-47	161-04700	Inner Wheel Half Assy.				1	
2	13836	214-00100	Cup-Bearing	1	1	1	1	
3	162-27	162-02700	Outer Wheel Half Assy.	1	1			
	162-45	162-04500	Outer Wheel Half Assy.			1		
2	13836	214-00100	Cup-Bearing	1	1	1	1	
4	*164-20	164-02000	Brake Disc Assy.	1	1	1		
	164-3	164-00300	Brake Disc Assy.					1
5	AN5-35A	103-20400	Bolt	3	3	3	3	
6	AN960-516	095-10500	Washer	3	3	3	3	
7	AN365-524	094-10400	Nut	3	3	3	3	
8	13889	214-00200	Cone-Bearing	2	2	2	2	
9	153-4	153-00400	Ring-Grease Seal	4	2	4		
	153-3	153-00300	Ring-Grease Seal		1			1
	153-9	153-00900	Ring-Grease Seal					2
10	153-15	153-01500	Ring-Grease Seal		1			1
11	154-3	154-00300	Felt-Grease Seal	2	1	2		
	154-8	154-00800	Felt-Grease Seal					1
12	154-13	154-01300	Felt-Grease Seal		1			1
13	155-1	155-00100	Ring-Snap	2	2	2	2	
	67-38	067-03800	Spacer-Axle					1
	157-9	157-00900	Dust Shield					1
	95-151	095-15100	Washer					3
	102-6	102-00600	Screw					3

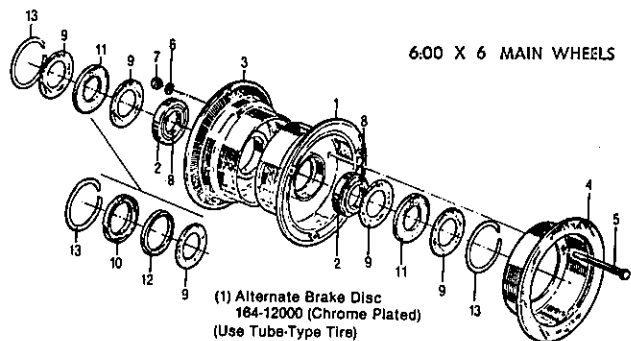

**QTY. PART PER NO. PLANE** HYDRAULIC BRAKE SYSTEM — MODEL F21  
**Hydraulic Brake Installation Kit Complete with Wheels & Brakes and all of the following parts.**

- B-A20-2R 1 Bar — Right Rudder Pedal
- B-A21-2L 1 Bar — Left Rudder Pedal
- 0978-11 1 Brace Assy — Hyd. Brake Cylinder Attach. — Welds on Fuselage
- 157-00900 2 Dust Shield
- AN936-A8 6 Star Washer — Dust Shield
- AN515-8-6 6 Screw — Dust Shield
- AN960-8 6 Washer — Dust Shield
- 3110 2 Master Cylinder — L. Side
- 3111 2 Master Cylinder — R. Side
- AN4H-4A 12 Special Bolt — Torque Plate to Axle Washer
- AN393-19 16 Clevis Pin
- AN380-2-2 16 Cotter Pin
- C-5305 X 4 2 Connector — For Hyd. Lines at Bottom of Fuselage
- 3159-2 2 Plug — For Brake Fluid Reservoir
- C-5405 X 4 4 90° Elbow
- C-5355 X 4 2 45° Elbow
- AN365-1032 3 Nut
- AN3-4A 3 Bolt
- DG5 1 Clamp
- DG10 3 Clamp
- RTM-675 8 Tie Wrap
- 3101-2 1 Hose Assy — 1½"

PART NO.	QTY. PER PLANE	HYDRAULIC BRAKE SYSTEM MODEL F21 CONT'D.
3101-3	1	Hose Assy — 14 $\frac{3}{4}$ "
3101-5	1	Hose Assy — 27 $\frac{1}{2}$ "
3101-6	1	Hose Assy — 16 $\frac{3}{4}$ "
2582-3	2	Hose Assy — 36 $\frac{3}{4}$ " (in Landing Gear)
3107	2	Brake Fluid Reservoir
3108	1	Parking Brake Control
3109	4	Rudder Pedals — Drilled (Cast Aluminum)

PART NO.	QTY. PER PLANE	MAULE TAILWHEELS
SFSA-1-2	1	Tailwheel — Solid Rubber Tire 6:50 x 2:50
SFSA-P8A-1-2	1	Pneumatic Tailwheel — 8 x 3:00

### MAULE TAILWHEEL PARTS LIST MODELS SFS, SFSA, SFS-P8 AND SFS-P8A

1	Cotter Pin 5 @	22	Bracket Assy. 1 1/4", 1 1/2, or 1 3/4 Inc. Pts. 7, 8, 10 & 59	58	P8 Fork
2	Nut 2 @	22A	Bracket Assy. 1 1/4", 1 1/2, or 1 3/4 Inc. Pts. 7, 8, 10 & 59A	58A	P8A Fork
3	1/16 Proj. Bearing (F-350-12)	23	6:50 x 2:50 Tire	58	P8 Fork W/Axle
4	1/16 Proj. Bearing (F-350-12) Inc. # 28 Washer	23	6:50 x 2:50 Tire with Bearings	58A	P8A Fork W/Axle
5	Axle with TW-6 Sirclip Ring	26	Felt	59	Oilite Bearing
6	Sirclip Ring 2 @	27	Hub Cap with Zerk & Screws	59A	Oilite Bearing
7	Zerk Fitting	28	Washer	60	Lock Ring Pin 2 @
8	Cam Screws 2 @	30	Inside Hub with Bearings	60A	Lock Ring Pin 2 @
9	Screw 3 @	31	Outside Hub	61	SFS Fork
10	Cam	32	Hub Cap	61A	SFSA Fork
11	Nut 3 @	33	Sirclip Ring	61	SFS Fork W/Axle
12	Plate	34	4/16 x 3/4 Hub Bolts 3 @	61A	SFSA Fork W/Axle
13	Lock Pin	35	5/16" Lock Washer 3 @	63	Cover Cap
13A	Lock Pin	38	P8 Wheel, Tire, & Tubes Assy. Inc. Pts. 7, 17, 18, 19, 30, 31, 32, 33, 34, 35	63A	Cover Cap
14	Spring	45	Washer	64	Washer
15	Steering Arm Assy.	57	Lock Ring		
15A	Steering Arm Assy.	57A	Lock Ring		
16	Nut				
16A	Nut				
17	8" x 3:00 Tube				
18	8" x 3:00 x 4 Tire				
19	Bearing				

NOTE: Letter "A" After Number is for New Type Tailwheel.

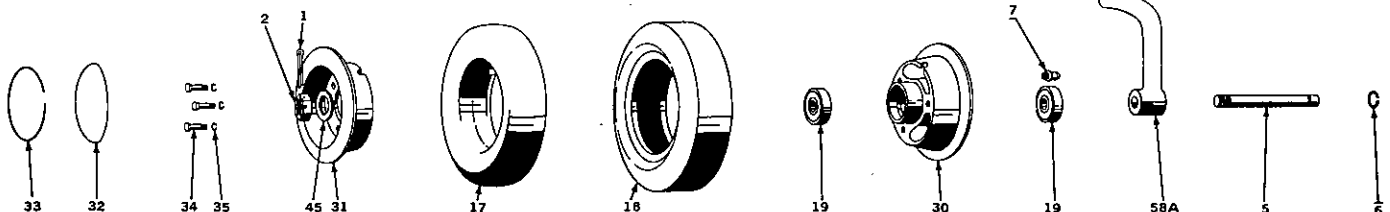
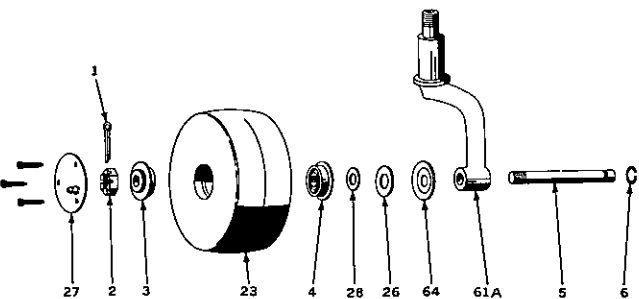
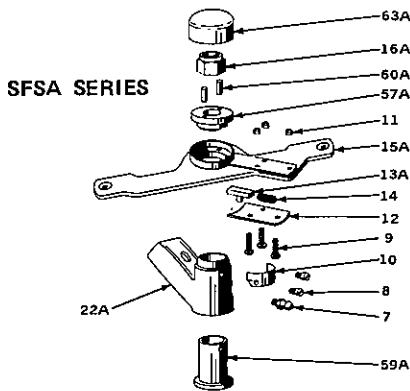

PART NO.	QTY. PER PLANE	
62A	1	Coil Spring — Lighter Spring Left Side
62B	1	Coil Spring — Heavier Spring Right Side
49	4	Clip
2688	1	Bushing to be used with Maule Tailwheel
2689	1	Bushing to be used with Scott Tailwheel

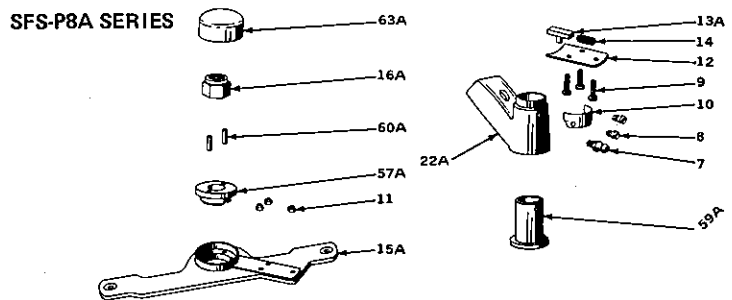

PART NO.	QTY. PER PLANE	HEATH TAILWHEEL — ORIGINAL EQUIPMENT
	1	Heath Steerable Tailwheel (Not Full Swivel)
	1	Tire — 2:00 x 6
2-14	2	Bearing
D-206	2	Disc
4-MS-1	4	Bolt
4-N-2	1	Nut
B-9140	1	Fork
AN7-34	1	Bolt
AN320-7	1	Nut
AN380-3-3	2	Cotter Pin
42-T-1005	1	Brass Washer
B-9139	1	Block
1641	1	Grease Fitting
B-9096	1	Brass Bushing
42-T-1002	1	Steel Washer
AN310-8	1	Nut
B-9138	2	Coil Spring for Heath Tailwheel Only

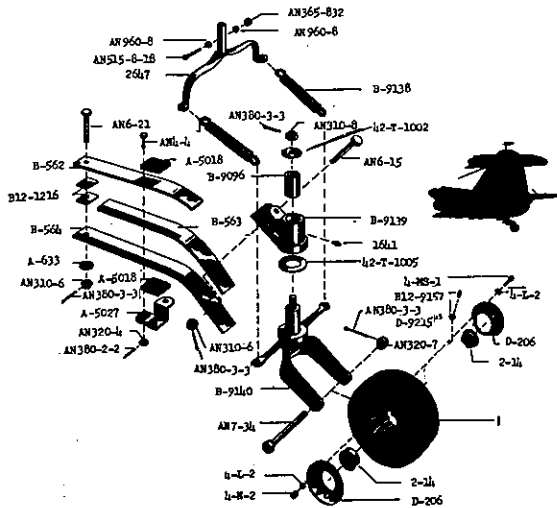

**FOLLOWING PARTS ARE FOR ALL TAILWHEELS**

2647	1	Rudder Arm — Steerable — Cast Aluminum — Machined & Drilled
B-562-3-4	1	Set Leaf Springs
AN6-15	1	Bolt — Rear Tailwheel Spring
AN310-6	2	Nut
B12-1216	2	Spacer — Front Tail Spring
AN6-21	1	Bolt — Front Tail Spring
AN960-616	1	Washer
A-5018	2	Felt Pad — Tailwheel Spring
A-5027	1	Clip — Lower Spring
AN4-6A	2	Bolt
AN960-416	6	Washer
AN365-428	2	Nut
AN380-2-2	2	Cotter Pin
AN3-11	2	Bolt
AN310-3	2	Nut
AN960-10	2	Washer

**BRAKE CONTROL & PARKING BRAKE FOR MODELS B & F19**

B-A55	1	Brake Control Cable — Right Wheel — B Models
B-A56	1	Brake Control Cable — Left Wheel — B Models
B-A505	1	Pedal Assy Complete w/equalizer cable — B Models
B-A505-1	1	Brake Pedal Assy — Left Wheel — Model F19
2646-1	1	Right Brake Assy Kit
B-528	2	Brake Pedal — Replacement
B-523	2	Clamp — Control Cable to Pedal
AN3-4A	2	Bolt for B-523
AN365-1032	2	Nut
AN111-8	4	Pulley — Brake Control Cable — Less Bushing

PART NO.	QTY. PER PLANE	BRAKE CONTROL (CON'D.)
A-920	4	Bushing
0828-2	1	Parking Brake Control
0703	2	Clamp — Parking Brake Control Cable
<b>TRIM TAB CONTROLS — ALL MODELS</b>		
B12-910	1	Cable — Trim Tab Control (Less Clamps & Springs)
A-246	1	Spring — Tab Control Tension
B-523	3	Clamp — Tab Cable at Spring
AN3-4A	6	Bolt for B-523
AN365-1032	6	Nut
AN960-10	6	Washer
B12-1080	1	Pulley — 3½"
B12-462	1	Pin — Pulley Lock
B12-9106	1	Crank — Trim Tab Control
B12-9109	1	Flange — Crankcase Cover
B12-140	1	Pin — Crank to Shaft Lock
B12-197	1	Indicator Shaft
D-9091	2	Washer
AN340-616	1	Nut for Shaft
B12-A130	1	Indicator Plate
B12-928	1	Placard — Nose Up Nose Down
B12-A136	1	Fairlead — Trim Tab Control Cable at Rear
B12-A137	1	Indicator Control Lever
B12-A138	1	Indicator Pointer Bracket
AN935-616	1	Lock Washer
1996	9	Copper Bushing — Fairlead for Trim Tab Guides

**EMPENNAGE INSTALLATION**

Three Hinge Tail Surfaces for Pre-War Models No Longer Available

D-A41-1	1	Rudder Assy Complete w/Tail Light Base — 2-Hinge Covered thru Silver
D-A410-1	1	Rubber Assy w/Tail Light Base — 2-Hinge Uncovered
0400-113	1	Navigation Light Bracket — Welds in Rudder — Replacement
*D-A451	1	Cover — Rudder
AN3-5	4	Bolt for Rudder Cables
AN320-3	4	Nut
AN960-10	4	Washer
AN380-2-2	4	Cotter Pin
B-410	1	Rudder Trim Tab
A-8036	As Req.	Bushing — Elevator & Rudder
A-48	As Req.	Rudder Hinge Pin
D-26	4	Link — Connector — Control Cable to Rudder Horn
D-A40-2	1	Fin Assembly
D-1151	1	Dahlstrom — Leading Edge of Fin
AN3-11	2	Bolt — Fin to Fuselage
AN320-3	2	Nut
AN960-10	4	Washer
AN380-2-2	2	Cotter Pin
B-A46-1	1	Fin For Float Installation
D-A44L/R	2	Stabilizer Assy — Covered thru Silver — State L or R
D-A419L/R	2	Stabilizer Frame Assy — Uncovered
*D-A495	2	Cover — Stabilizer
AN3-13A	4	Bolt — Stabilizer to Fuselage
AN365-1032	4	Nut
A-461	2	Rod — Stabilizer to Fuselage Brace — Bottom 41"
D-40	2	Rod — Stabilizer to Fin Brace — Top 44"

**NOTE: WE HAVE THE FOLLOWING LENGTHS FOR 3-HINGE TAIL SURFACES — 36" & 38½"**

AN4-17A	3	Bolt — Fin and Outer Stabilizer
AN365-428	3	Nut
AN960-416	6	Washer
AN4-4A	2	Bolt at Bottom of Fuselage
AN365-428	2	Nut
A-4001	2	Strap — Tie Rod to Bottom of Fuselage

PART NO.	QTY. PER PLANE	EMPENNAGE INST. CONT'D.
A-4008	2	Strap — Tie Rod to Fin
A-4009	4	Strap — Tie Rod to Stabilizer — Bottom
A-4002	8	Insert — Tie Rod Straps
A-986	8	Nipples — Tie Rod Ends
AN345-8	8	Hex Nut — Tie Rod Lock

**NOTE: WHEN REPLACING NIPPLES, INSERTS MUST ALSO BE REPLACED DUE TO DIFFERENT SIZE FROM ORIGINAL.**

ELEVATOR INSTALLATION		
D-A43	1	Right Elevator Assy-Covered thru Silver — 2 Hinge
D-A420	1	Right Elevator Assy Frame — Uncovered
*D-A409	1	Cover — Right Elevator
D-A403	1	Left Elevator Assy Less Trim Tab — Covered Thru Silver 2-Hinge (Includes Mechanism for Trim Tab)
D-A411	1	Left Elevator Assy Frame Less Trim Tab — Uncovered
*D-A412	1	Cover — Left Elevator
B12-A45	2	Connector Link — Elevator Cable to Horn
AN3-7	2	Bolt — Cable Attachment
AN3-5	2	Bolt — Cable Attachment
AN320-3	4	Nut
AN960-10	4	Washer
AN380-2-2	4	Cotter Pin
A-48	As Req.	Elevator Hinge Pin
1095	2	Stop — Elevator Travel
AN320-6	2	Nut for 1095 Stop
1673-1	1	Trim Tab — Aluminum for 2-Hinge Elevator
B12-406	1	Trim Tab — Trim Tab Actuating
B12-408	1	Spacer — Pulley to Nut
B12-461	1	Pulley — Trim Tab — 2" Dia.
B12-462	1	Pin — Pulley Lock
D-419	1	Connector — Tab
D-441	1	Pin — Connector Tab
D-4024	1	Pin — Tab Bearing
D-9091	1	Washer — Pulley Bearing
D-A400	1	Link Rod Assy — Trim Tab
D-A401	1	Drive Assy — Trim Tab
D-A406	1	Bellcrank — Trim Tab Actuating
B-49	2	Trim Tab — Old Style under Stabilizer
B-43	1	Spar for B-49 Trim Tab
A-7007	2	Inspection Plate at Bottom of Vertical Fin
A-7008	2	Plastic Frame for A-7007
0964-5	1	Spacer for A-7007
AN515-6-32	1	Screw
AN365-632	1	Nut
AN960-6	4	Washer

\*Covers in 2.7 oz. Dacron or Grade A Cotton Only

FAIRING INSTALLATION — FUSELAGE		
B-708 L/R	2	Wood Fairing — Top Longeron
B-756 L/R	2	Wood Fairing — At Wing Butt
B12-1198 L/R	2	Wood Fairing — Lower Longeron
B12-A104-1	1	Wood Fairing — Top Fuselage Cross Tube — Top of Windshield
2373	2	Wood Fairing — Top of Door Frame for Headliner Attachment — BC12D & Later
1829-1	1	Metal Fairing — Fuselage Front at Landing Gear
B-A77 L/R	2	Cable Cover at Bottom of Door Frame — Pre-War Models — State L or R
1654	1	Cable Cover — Left — Bottom of Aluminum Door Frame
1655	1	Cable Cover — Right — Bottom of Aluminum Door Frame
B-76 L/R	2	Nose Piece — Butt Rib at Windshield — Models BC12D & Later — State L or R
1762-1 L/R	2	Cable Cover — Front Door Post — Upper — State L or R BC12D & Later

PART NO.	QTY. PER PLANE	FAIRING INST. CONT'D.
1763 L/R	2	Cable Cover — Front Door Post — Lower — State L or R BC12D & Later
1762-4 L/R	2	Cable Cover — Front Door Post — Upper — State L or R Ser. No. F-027 & Up — Models F19 & F21
1763-1 L/R	2	Cable Cover — Front Door Post — Lower — State L or R Ser. No. F-027 & Up — Models F19 & F21
B12-A771-1 L/R2		Metal Fairing — Wedge Shape — Attach to Fuselage at Rear of Wing
2419 L/R	2	Metal Wing Band Fairing — Installs around entire wing at fuselage — screws included — State L or R — BC12D & Later
AN515-6-64	2	Screw — Replacement
2620	As Req.	Rubber Channel
1770 L/R	2	Metal Fairing — Attaches to Fuselage over Door (Specify year of manufacture of plane)

**NOTE: WE CAN NO LONGER FURNISH WOOD STRINGERS. THE FOLLOWING METAL STRINGERS ARE REPLACEMENT. DUE TO LENGTH, STRINGERS ARE TO BE ASSEMBLED BY CUSTOMERS. THEY CANNOT BE SHIPPED VIA U.S. POSTAL SERVICE EXCEPT TO ALASKA.**

Stringer Installation Kit Complete with Metal Support, Wood Blocks & Springs

2245-2	1	Metal Stringer Support — Rear of Floorboard
S68-3600	1	Bottom Stringer — 36" Rivets to 2245-2 — All Models
S68-4800	2	Stringer — Side Bottom — 48" — All Models
S68-15600	2	Stringer — Top — 156" — All Models
S68-12600	2	Stringer — Side Top — 126" — B Models
S68-13816	2	Stringer — Side Center — 138½" — B Models
S68-9000	1	Stringer — Top Left Reinforcement — 90" — Models F19 & F21
S68-10900	2	Stringer — Side Center — 109" — Model F19
S68-3000	2	Stringer — Side Top — 30" — Model F19
S68-9600	2	Stringer — Side Center — 96" — Model F21
S68-2216	2	Stringer — Side Top — 22½" — Model F21

#### SEAT INSTALLATION

1202-1 & 1204-1	1	Set Seat Cushion — Red, Blue or Black
A-A73	1	Front Seat Canvas (Including Cord)
A-73	1	Wood Piece — Front of Seat Canvas
B-A71	1	Anchor Assy — Safety Belt
AN115-32	4	Shackle for B-A71
AN394-17	4	Clevis Pin for B-A71
A-929	2	Safety Belt — Black
B12-A703	1	Panel — Seat Front
0967-1	1	Baggage Compartment Canvas — B Models
B-769-1	2	Headlining Bow — Front & Center — B Models
B-770-1	1	Headlining Bow — Rear — B Models

#### FLOORBOARD INSTALLATION

1850-2	1	Left Floorboard for all Models After 1945
1850-3	1	Right Floorboard — No cutout for right brake assy
1850-12	1	Right Floorboard — Cutout for right brake assy
AN515-R6-8	8	Screw
B-716	As Req.	Heel Plate
1850-14	1	Left Floorboard — Model F21 for Hydraulic Brakes
1850-15	1	Right Floorboard — Model F21 for Hydraulic Brakes
1133-6	2	Heel Plate — Model F21
B-720	1	Carpet — Red, Blue or Black — State part number of floorboards

#### REAR WINDOW INSTALLATION — DELUXE B MODELS

1245 L/R	2	Rear Window Frame — State L or R
1354 L/R	2	Window
1244	1	Installation Kit for Rear Window

PART NO.	QTY. PER PLANE	HEADLINER INSTALLATION FOR MODELS F19 & F21
2604 L/R	2	Nose Piece — State L or R
2605 L/R	2	Front Section — State L or R
2606-1	1	Center Section
2607	1	Rear Section
<b>BAGGAGE COMPARTMENT INSTALLATION FOR MODEL F19</b>		
2600-2 L/R	2Pr.	Window Frame — Inside & Outside
2600-5	2	Windows
2593-10	2	Wood Center Strip on Top of Window Frame
2594-1	2	Wood Strip below Window Frame
2594-2	2	Wood Strip above Window Frame
2601-5	1	Floorboard — Plywood
2602	1Set	Cargo Tie Downs
2601-6 L/R	2	Sides — Baggage Compartment
2601-8	1	Rear Section — Baggage Compartment
2601-9	1	Front Section — Baggage Compartment
2593-11	1	Wood Strip for back of Rear Section
2644-1	2	Wood Trim inside of Door Frame at Front of Window
2644-2	2	Metal Moulding
<b>BAGGAGE COMPARTMENT INSTALLATION FOR MODEL F21</b>		
2700-2	2	Outside Window Frame (Under Fabric)
2700-4	2	Inside Frame Assy (In Baggage Compartment)
2700-10	2	Outside Frame (for Window)
2700-13	2	Window
2601-5	1	Floorboard — Plywood — Baggage Compartment
2602	1Set	Cargo Tie Downs
2601-8	1	Rear Section — Baggage Compartment
2601-9	1	Front Section — Baggage Compartment
2601-21 L/R	2	Side Sections for 2700-1 Window Installation
2593-11	1	Wood Strip for back of Rear Section
2601-25	1	Baggage Compartment Extension Assy Kit Complete (6" Dia. x 4' Tube)

2683 1 Shoulder Harness Installation Kit approved on late Model F19's and F21's.

Approval must be obtained as a field approval on Form 337 according to FAR Part 43.

**FOLLOWING ARE REPLACEMENT PARTS FOR SHOULDER HARNESS INSTALLATION**

2683-1	2	Cable Assy
2684-1	2	Strap Assy
2685-1	2	Strap with Slide & Buckle

**WINDSHIELD INSTALLATION**

B-A700	1	Windshield — One-Piece — "B" Models thru Yr. 1942
1551	1	Windshield — 1945 BC12D & Later
1551-6300	1	Rubber Moulding — Bottom of Windshield
1132	1	Metal Fairing — Bottom of Windshield — for 1551 Windshield Only — Hdwe. Included
1144-2	1	Metal Strip — Top Windshield Trim Hdwe. Incl.
1144-3	2	Metal Strips — Side Windshield Trim — For 1551 Windshield Hdwe. Incl.
B12-7071	2	Metal Strips — Side Windshield Trim — for B-A700 Windshield Hdwe. Included
1148-2	1	Seal — Top Strip
1148-3	1	Seal — Side Strips for 1144-3
	2	Seal — Side Strip for B12-7071
D-984	2	Snap-Vent — Ventilator
A-745-1	4	Rubber Support Pads — Windshield Center for D-1231
D-1231	4	Wire Support — Welds on Fuselage
B-9067	6	Special Nut — Top of Windshield
AN515-8-12	6	Screw — Top of Windshield
2620	As Req.	Rubber Channel Around Wing Band

PART NO.	QTY. PER PLANE	METAL DOOR INSTALLATION
1620-28L/R	2	Door Assy — Single Curve (Single Curve Aluminum Door Started with NC96060)
1900-1 L/R	2	Door Frame — Aluminum for 1620-28 Door
1620-2L/R	2	Window — Front Sliding — State L or R
1620-21	2	Window — Rear
0400-93	2	Handle — Front Sliding Window — Replacement
1620-23	2	Front Window Brace — Replacement
1620-27	2	Rear Front Window Brace — Replacement
1620-3L/R	2	Window Frame — State L or R
1620-19	2	Channel — Center of Window Frame — Replacement
1620-16	4	Felt Pad — 1/16 x 3/4 x 12 1/2"
1620-17	4	Felt Pad — 1/16 x 3/8 x 12 1/2"
1620-25	4	Felt Pad — 1/16 x 3/4 x 27 1/2"
1620-26	6	Felt Pad — 1/8 x 3/4 x 12 3/4"
1653-1L/R	2	Hinge — Upper — State L or R
1653-2L/R	2	Hinge — Lower — State L or R
2340L/R	4	Hinge — Installs on Door Frame — State L or R
AN507-6-12	10	Screw
AN365-6-32	10	Nut
2502	4	Tear Drop Fairing — Door Hinge — For all — metal door only
1795-1	2	Latch Assy — Door
1599-5	4	Handle — Door Latch
1703	4	Pin — Door Handle
1789	2	Link — Inside to Outside Door Handle
1791	2	Striker Plate
1620-35 L/R	2	Vinyl Panels install on inside of 1620-28 door — Red, Blue or Black
<b>FUSELAGE FRAMEWORK</b>		
0893	1	Fuselage Frame Assy — Complete Welded Structure — No Landing Gears or Tail Surfaces

**FOLLOWING ARE REPLACEMENT PARTS FOR 0893**

		Fuselage Cabin Section forward to motor mount bulkhead
		Fuselage Section Aft of Cabin to Tailpost
B-A1812	1	Upper Cabin Section with 4 Butt Fittings
B-A1830	1	Fin & Rudder Post
A-1135	2	Strap — Lower Tail Wires
A-1148	1	Rear Tail Spring Attachment Fitting
B-165	2	Lift Handle
D-A153	1	Front Tail Spring Attachment Fitting

**NOTE: ANY FUSELAGE TUBES CAN BE PURCHASED. REFER TO DIAGRAM AT BACK OF CATALOGUE. MATERIAL IS ALL 4130 STEEL TUBING, CUT AND NIBBLED TO SIZE.**

*2631	1	Cover Only — Fuselage and Vee Fin
*	1	Cover Only — Complete Wings, Fuselage & Vee Fin, & Controls.

\*2.7 OZ. DACRON OR GRADE A COTTON COVER ONLY.

**WING INSTALLATION**

0870-1 L/R	2	Wing Panel — Complete thru Silver — Less Fuel Tank
0870-1 L/R	2	Wing Panel — Complete thru Silver — With Fuel Tank
0886-1 L/R	2	Wing Frame Assy — Uncovered — Less Fuel Tank
0886-1 L/R	2	Wing Frame Assy — Uncovered — With Fuel Tank

**NOTE: CUSTOMER MUST MAKE ARRANGEMENTS TO PICK UP AT PLANT IF POSSIBLE**

PART NO.	QTY. PER PLANE	WING CONT'D.
2632-1	2	Wing Cover — 2.7 Oz. Dacron or Grade A Cotton Only
A-8104	24	Inspection Ring — Acetate
B-9094	24	Inspection Plate
A-8028	As Req.	Drain Grommets
B12-A80	2	Spar Assy Complete — Front — 65 HP & 85 HP
2570	2	Spar Assy Complete — Front — Models F19 & F21
B-A88	2	Spar Assy Complete — Rear — All Models
2570-3	10	Spar Bushing — Lift Strut — 15/32 OD — Replacement
2570-4	10	Spar Bushing — Butt — 11/16 OD — Replacement
A-844	4	Wire — At Wing Bow & Thru B-80 Tube between Lift Strut Fittings
AN365-440	12	Nut — For A-844 Wire
B-80	2	Tube — Between Lift Strut Fittings
B-808	2	Spacer — Rear Lift Strut Fitting at Tie Rod
A-8003	16	Drag Wires — Inboard
A-8020	4	Drag Wires — Outboard
A-8089	40	Nipples — Drag Wire Ends
AN315-640	40	Nut Lock — Drag Wires
B-A800	2	Drag Strut at Lift Strut Fitting No. 5
B-A801	10	Drag Strut Nos. 1, 2, 3, 4, 6
AN4-11A	24	Bolt
AN4-12A	16	Bolt
AN4-13	8	Bolt
AN365-428	40	Nut
AN310-4	8	Nut
AN970-4	40	Washer
B-A835	2	Jury Strut Upper Cross Tube
AN3-11	2	Bolt
AN3-12A	2	Bolt
AN310-3	2	Nut
AN365-1032	2	Nut
B-809 L/R	4	Rear Spar Strut Fitting — 65 HP — State L or R Specify Front or Rear of Rear Spar
AN5-12	4	Bolt
AN310-5	4	Nut
AN4-13	4	Bolt
AN310-4	4	Nut
B-809-2 L/R	2	Rear Spar Strut Fitting — 85 HP & Models F19 & F21
AN4-13	4	Bolt
AN310-4	4	Nut
AN380-2-2	8	Cotter Pin
AN5-12	4	Bolt
AN310-5	4	Nut
B-A809-2 L/R	2	Front Spar Strut Fitting — 85 HP & Models F19 & F21
AN4-13	10	Bolt
AN310-4	10	Nut
AN380-2-2	10	Cotter Pin
AN960-416	6	Washer
A-A806	2	Front Spar Butt Fitting — 65 HP
A-A806-1	2	Front Spar Butt Fitting — 85 HP, Models F19 & F21
AN4-13A	10	Bolt
AN365-428	10	Nut
AN960-416	10	Washer
A-A807	2	Rear Spar Butt Fitting — All Models
AN4-11A	2	Bolt
AN4-13A	2	Bolt
AN365-428	4	Nut
AN960-416	4	Washer

1553-1 L/R 2 Center Hinge Bracket Assy Complete — Magnesium Only — State L or R

FOLLOWING ARE REPLACEMENT PARTS FOR 1553-1 ASSY

1212 L/R	2	Center Hinge Bracket
1211 L/R	2	Brace for Center Hinge Bracket — State L or R
1210	2	Horn (Bellcrank) Complete with Bushings

PART NO.	QTY. PER PLANE	WING CONT'D.
A-245	2	Fibre Bushing
B12-886	2	Universal Ball Stud — Aileron Control — Short
AN320-4	2	Nut
AN3-7A	4	Bolt
AN365-1032	4	Nut
AN970-4	2	Washer
AN960-416	6	Washer
AN960-10	2	Washer
AN960-10L	4	Washer
AN4-31	2	Bolt
AN310-4	2	Nut
AN380-2-2	4	Cotter Pin
AN960-616	2	Washer
1553-2	2	Outboard Hinge Bracket Complete — Magnesium Only
FOLLOWING ARE REPLACEMENT PARTS FOR 1553-2 ASSY		
1552	2	End Fitting
AN3-7A	4	Bolt
AN365-1032	4	Nut
AN960-10	2	Washer
AN960-10L	2	Washer
1660	4	Reinf. Clip
AN515-6-8	2	Screw
1777-6Z1	2	Tinnerman Nut
1553-3	2	Inboard Hinge Bracket Complete — Magnesium Only
FOLLOWING ARE REPLACEMENT PARTS FOR 1553-3 ASSY		
1552	2	End Fitting
AN3-7A	4	Bolt
AN365-1032	4	Nut
AN960-10	2	Washer
AN960-10L	2	Washer
1660	4	Reinf. Clip
AN515-6-8	2	Screw
1777-6Z1	6	Tinnerman Nut
0981-1	2	Fairlead
AN970-3	14	Washer — Attach Hinge Brackets to Spar
AN3-13A	14	Bolt
AN365-1032	14	Nut
1615	As Req.	Shim (.016, .032 or .064 Thick)
A-8036	6	Bushing — Oilite for Aileron
A-8001	6	Aileron Hinge Pin
B12-A754	1	Pitot Tube Assembly Complete
A-745	1	Rubber Hose Connector
B-206	3	Connector Links — Aileron Control Cable to Wing Aileron Cable
AN3-5	2	Bolt
AN3-11	2	Bolt
AN320-3	4	Nut
AN380-2-2	4	Cotter Pin
AN960-10	8	Washer
B-A202	4	Cable — Aileron Front & Rear (Used with B-206 Connector Links)
AN960-10L	2	Washer
A-8096	4	Guide — Aileron Cable
0932-4	2	Wing Tip Bow with Light Bracket Welded on — for Wings with 3-pc. metal stamped ribs only
AN515-6-16	2	Screw
AN515-R6-18	2	Screw
AN365-632	4	Nut
1616-4	4	Plate — Reinf. at Spar Tip Wing Bow Fitting
0400-112	2	Navigation Light Bracket — Replacement
B12-875-1	2	Leading Edge — Outboard — 54 1/4"
B12-875-2	2	Leading Edge — Inboard — 64"
B12-875-3	2	Leading Edge — Center — 57 1/4"
D-A8295 L/R	2	Leading Edge Tip

PART NO.	QTY. PER PLANE	WING CONT'D
<b>NOTE: ABOVE LEADING EDGE FOR WINGS WITH 3-PC. METAL STAMPED RIBS ONLY</b>		
	226	4 X 1/4 Self Tapping Screws
	86	4 X 3/8 Self Tapping Screws
0970-4 L/R	2	Aileron Bay Housing — Inboard Sect. — State L or R
0970-5 L/R	2	Aileron Bay Housing — Outboard Sect. — State L or R
0970-6 L/R	2	Aileron Bay Housing — Center Sect.
1715	2	Brace — Bottom of Aileron Housing to Spar at Tip
0931-1	2	Trailing Edge — Wing — Specify whether for 3-pc. metal stamped ribs or 1-pc. built-up, truss type.

**NOTE: TRAILING EDGE IS TOO LONG TO BE SHIPPED VIA PARCEL POST EXCEPT TO ALASKA**

A-8013 4 Brace — Trailing Edge to Spar

THE FOLLOWING ARE THREE-PIECE, METAL STAMPED RIBS AND ARE INTERCHANGEABLE WITH THE ONE-PIECE, BUILT UP TRUSS TYPE USED ON EARLIER MODELS. ADAPTER 1540 IS REQUIRED ON AILERON HOUSING RIBS DUE TO DIFFERENCE IN CONTOUR OF HOUSING TIP RIBS CAN BE USED ON EARLY MODELS EXCEPT TIP LEADING EDGE D-A8295 MUST BE USED.

WHEN ORDERING RIBS, STATE WHETHER FOR LEFT OR RIGHT WING. L & R DESIGNATES DIRECTION OF FLANGE LOOKING FROM FRONT TO REAR OF WING. CHECK DIAGRAM AT BACK OF CATALOGUE.

1540	As Req.	Adapter
0873-1 L/R	22	Nose Rib — Between Full Ribs
0873-2 L/R	4	Nose Rib — Between Full Ribs
0897-1 L/R	2	Tip Rib
0928-1 L/R	2	Butt Rib (Shipped in 5 pcs. to be assembled by customer)
1401-1 L/R	24	Nose Rib
1401-2 L/R	2	Nose Rib
1402-1 L/R	24	Center Rib
1402-2 L/R	2	Center Rib
1403-1 L/R	14	Trailing Rib
0890-2 L/R	2	Reinf. Rib for 1403-1 at Aileron
1404-1 L/R	8	Aileron Bay Rib
1404-900 L/R	2	Aileron Bay Rib
1404-901 L/R	2	Aileron Bay Rib
AN931-3-10	26	Grommet for Navigation Light Wires
150 ft.		Rib Stitching Wire (1 Wing)
300 ft.		Rib Stitching Wire (2 Wing)

Wing to Fuselage Bolt & Nut Kit — (2) AN4-14, (2) AN5-16, (2) AN310-4 (2) AN310-5

#### AILERON INSTALLATION

B-A804 L/R	2	Aileron Assembly Covered thru Silver
B-A804-1 L/R	2	Aileron Frame Assembly Uncovered
A-8065	2	Cover — Aileron — 2.7 oz. Dacron or Grade A Cotton Only
A-8028	As Req.	Drain Grommets
A-A810 L/R	2	Aileron Spar — State L or R
B-836	12	Reinf Plate at Hinge Fittings — Replacement
A-A853 L/R	2	Aileron Bow — State L or R
A-8116 L/R	2	Aileron Leading Edge Tip
A-8117	2	Aileron Leading Edge — Inboard
1576-6	2	Aileron Leading Edge — Center

PART NO.	QTY. PER PLANE	AILERON CONT'D.
	184	4 x 1/4 Self Tapping Screw
	4	4 x 3/8 Self Tapping Screw
		10z. 19 x 3/8 Cement Coated Nails
		20z. 19 x 1/2 Cement Coated Nails
A-871	6	Aileron Hinge Fitting
A-872	2	Aileron Control Fitting
A-8045 L/R	2	Bracket — Aileron Control Fitting Reinf. — State L or R
AN3-13A	10	Bolt
AN3-10A	8	Bolt
AN970-3	18	Washer
AN365-1032	18	Nut
A-898	2	Ball Stud — Aileron Control — Long
A-8033	2	Spacer — Ball Stud Shaft to Fitting
A-899	2	Brace — Tip of Inboard Rib to Spar
A-867	4	Gusset — Top & Bottom of Aileron at Center Hinge
A-8024-1	2	Brace — Tip of Outboard Rib to Spar
B-85 L/R	10	Main Rib
B-85-1 L/R	2	Rib at Bow — State L or R
B-85-2 L/R	4	Rib at Reinf.
B-805 L/R	2	Butt Rib — State L or R
B-829 L/R	20	Nose Bulkhead Rib
A-8043	2	Tip Rib — State L or R
0923-2 L/R	2	Nose Tip Rib — State L or R
B-880-1	2	Trailing Edge

A-A837 1 Aileron Control Link Assy — Right Wing  
A-A839 1 Aileron Control Link Assy — Left Wing

#### FOLLOWING ARE REPLACEMENT PARTS FOR A-A837 & A-A839 ASSY

A-896	4	Inner Seat
A-897	4	Outer Seat
A-8062	1	Left Aileron Control Outer Sleeve
A-8063	2	Aileron Control inner Sleeve
A-8068	1	Right Aileron Control Outer Sleeve

#### WING STRUTS & TRIM

B-A839-1 1 Left Jury Strut Complete

#### FOLLOWING ARE REPLACEMENT PARTS FOR B-A839-1 ASSY

B-A839-2	1	Rear Tube
B-A839-3	1	Front Section
B-7066	1	Airspeed Pitot Tube

A-A817-1 1 Right Jury Strut Complete

#### FOLLOWING ARE REPLACEMENT PARTS FOR A-A817-1 ASSY

A-A817-2	1	Front Section
A-A817-3	1	Rear Tube

AN3-15A	8	Bolt
AN365-1032	8	Nut
A-A819	4	Jury Strut Adjusting Screw
A-892	2	Clamp — Jury Strut to Front Lift Strut
2690	2	Clamp — Jury Strut to Front Lift Strut — Starting with Model F19 Ser. No. F-137 and all front lift struts purchased from factory after 1-1-79.
1296	2	Clamp — Jury Strut to Rear Lift Strut — For 2.360" Struts only.
A-A815	2	Front Lift Strut — We can now only supply new size larger front lift struts. They are interchangeable with the previous front strut. 3.48x1.187. Strut Cuffs, Clamps & Tie Down Clamps must be replaced.
A-A854	2	Rear Lift Strut — Interchangeable with narrower struts used on 1941 and earlier models. Must purchase 1296 clamps.
AN5-25	2	Bolt
AN5-13	2	Bolt
AN5-15	2	Bolt



PART NO.	QTY. PER PLANE	WING STRUTS & TRIM CONT'D.
AN310-5	6	Nut
A-884	2	Adjusting Screw — Rear Lift Strut — Replacement
A-885	2	Barrel for A-884 — Replacement
B-A833 L/R	2	Strut Cuff — Rear Strut — State L or R — Specify Aluminum or ABS Plastic—Hdwe. Included
B-A834 L/R	2	Strut Cuff — Front Strut — State L or R — Specify Aluminum or ABS Plastic — for smaller front strut—Hdwe. Included
B-A834-1 L/R	2	Strut Cuff — Front Strut — State L or R — Specify Aluminum or ABS Plastic — for Front Struts starting with Model F19 Ser. No. F-137 and all struts purchased from factory after 1-1-79 Hdwe. Included

(To install strut cuffs, wrap around strut and drill two holes for self-tapping screws. Slide up to top of strut and drill one hole through into lift strut fitting and fasten with self-tapping screws).

WHEEL PANT INSTALLATION		
2750	2	Wheel Pants — Streamline or Teardrop (Specify which type)
FOLLOWING PARTS ARE FOR ATTACHING WHEEL PANTS TO TAPERED AXLE LANDING GEAR		
0888	2	Hex. Axle Nut — Threaded
2670-3	1	Bracket — Left Inside Mount — Steel Only
2670-4	1	Bracket — Right Inside Mount — Steel Only
AN503-416-8	2	Screw — Pant to Axle Nut
AN365-524	2	Bolt
AN5-21A	2	Nut
AN4-4A	12	Bolt
AN365-428	12	Nut
AN935-416	12	Lock Washer
Complete attaching kit includes all of above parts and reinforcements for wheel pants		

FOLLOWING PARTS ARE FOR ATTACHING PANTS TO STRAIGHT AXLE LANDING GEAR WITH MECHANICAL BRAKES — MUST GET FIELD APPROVAL		
2666-6	2	Tubes — Axle Mounting
2670-3	1	Bracket — Left Inside Mount
2670-4	1	Bracket — Right Inside Mount
AN970-4	2	Washer
AN5-21A	2	Bolt
AN365-524	2	Nut
AN4-4A	14	Bolt
AN935-416	14	Lock Washer
Complete attaching kit includes all of above parts and reinforcements for wheel pants		

FOLLOWING PARTS ARE FOR ATTACHING PANTS TO STRAIGHT AXLE LANDING GEAR WITH HYDRAULIC BRAKES — MODEL F21		
2755	2	Axle Nut Assembly
2658	2	Bracket — Attaching
AN970-4	2	Washer
AN970-3	8	Washer
AN935-416	10	Lock Washer
AN4-5A	2	Bolt
AN4-4A	8	Bolt
AN380-4-8	2	Cotter Pin
Complete attaching kit includes all of above parts and reinforcements for wheel pants		

**MISCELLANEOUS EQUIPMENT**  
 Aircraft Log Book  
 Engine Log Book  
 Tie Down Rings — Regular Front Struts

PART NO.	QTY. PER PLANE	MISC. EQUIP. CONT'D.
		Tie Down Rings — Front Struts manufactured after 1-1-79
		½" Self-Adhesive Acoustical Foam Kit (Rear Cowl & Firewall, Floorboards, Deck Panel & Bottom Pan)
		Taylorcraft Back Patches — Gold on Blue, Black on Silver (Specify Large or Small)
		Taylorcraft Hats — Reg. or Large
		Comm. Antenna
		Nav. Antenna
		Whips — Replacement

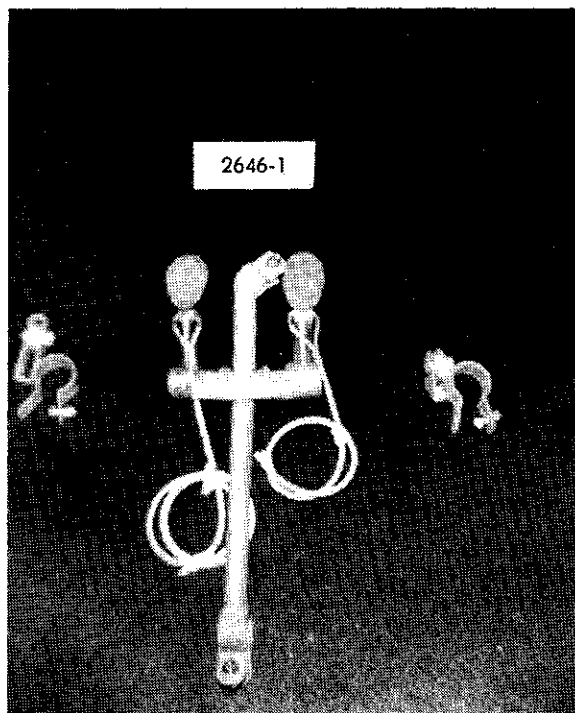
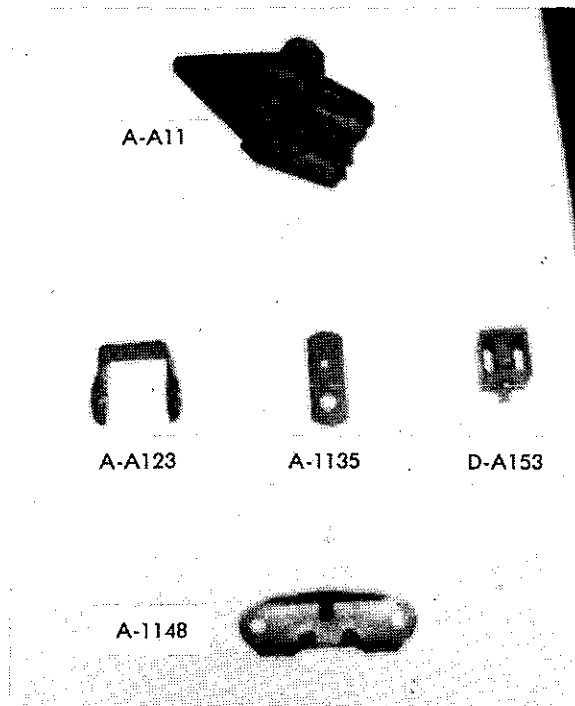

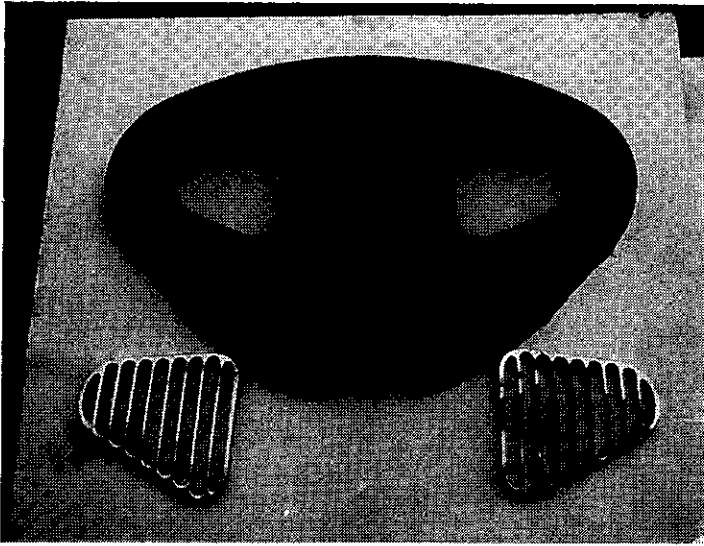

B-A6014-2 For  
B-A681-2 & B-A681-5 & B-A 681-19

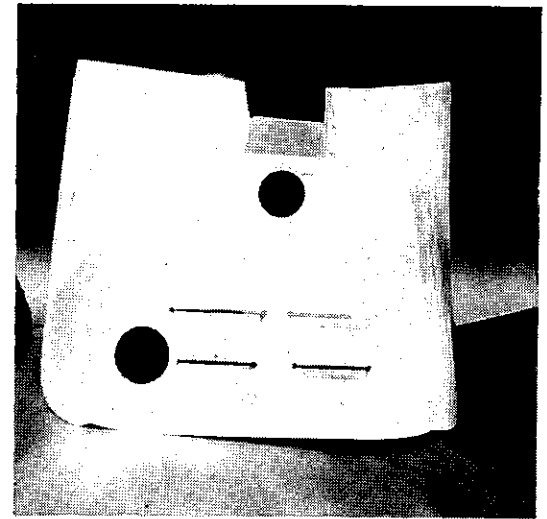

← B-6074

B-A681-5

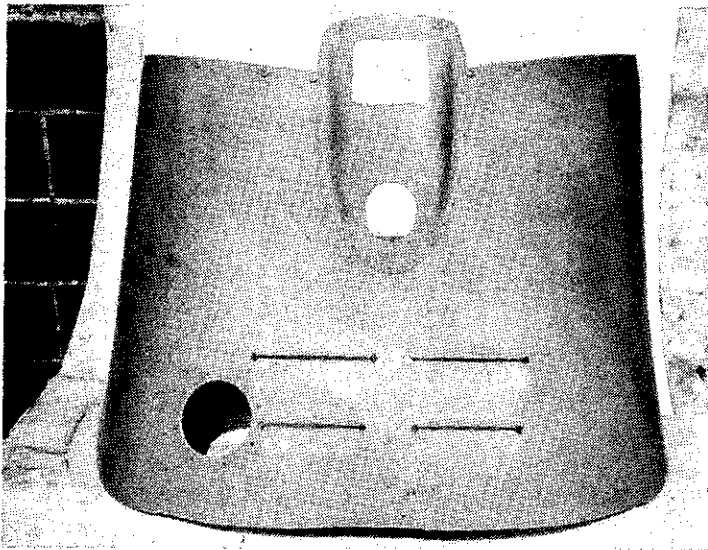

B-A681-2

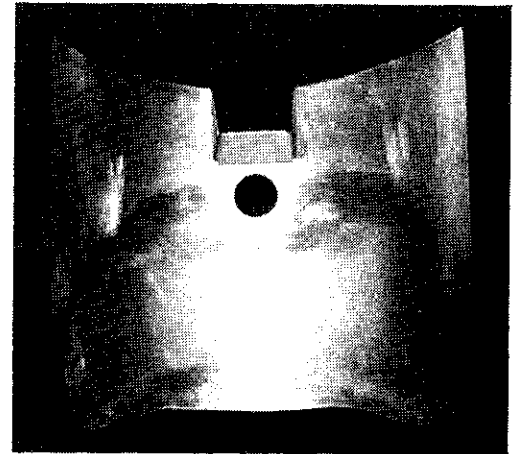

B-A681-19 Long Mount



BC-A6014

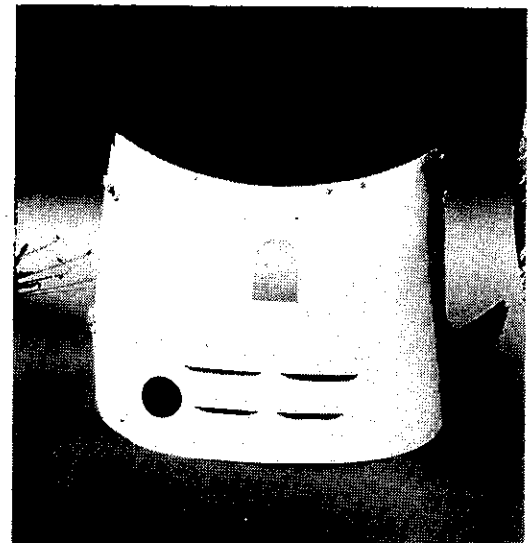

B-A681  
Specify Dzus or Trunk Latch

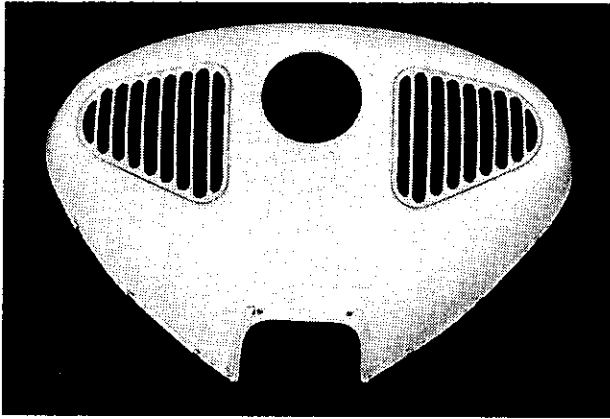

B-A6014-1 F19 Cowl  
For B-A681-3

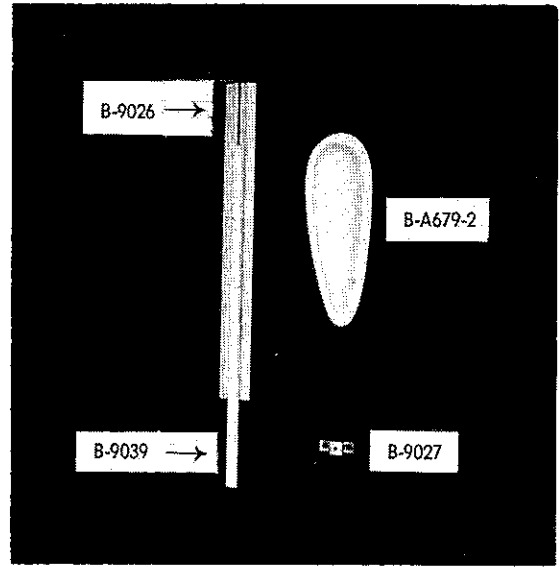

B-9026 →

B-A679-2

B-9039 →

B-9027

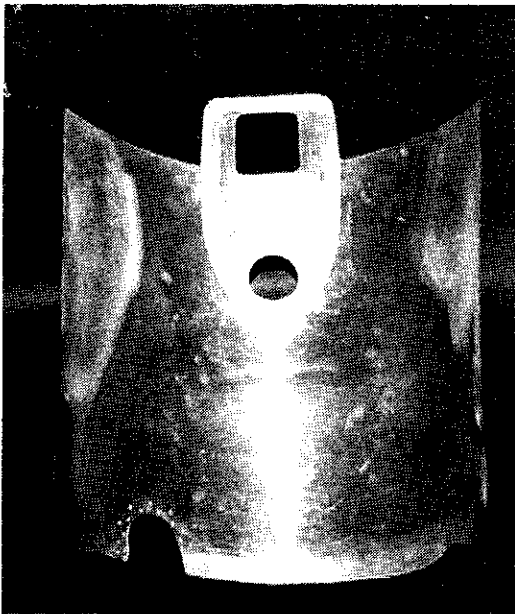

B-A681-3-F19 Cowl

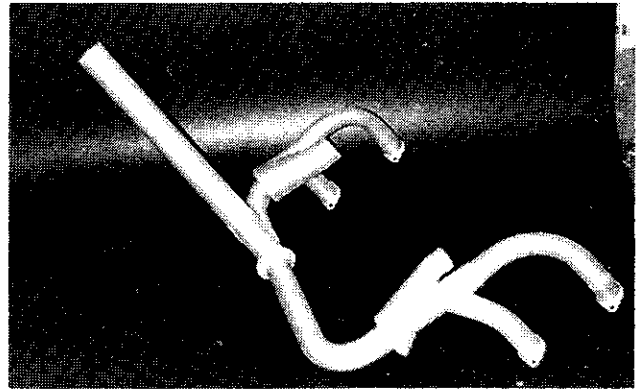

BC-A6031

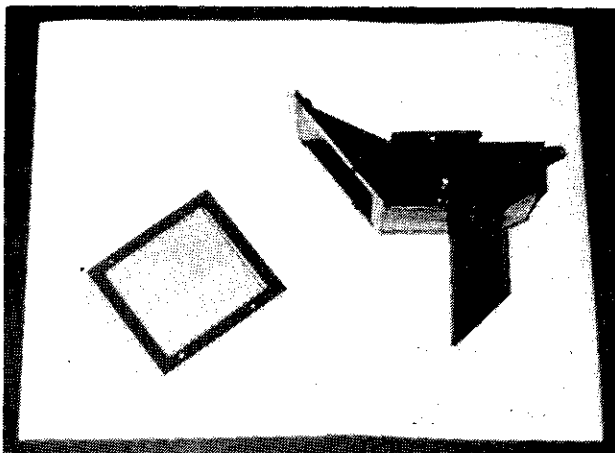

B-A4106

A-50256

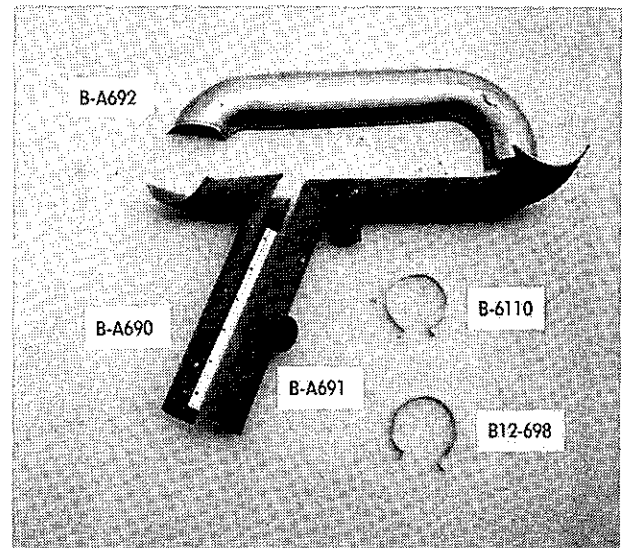

B-A692

B-A690

B-A691

B-6110

B12-698

BC-A689

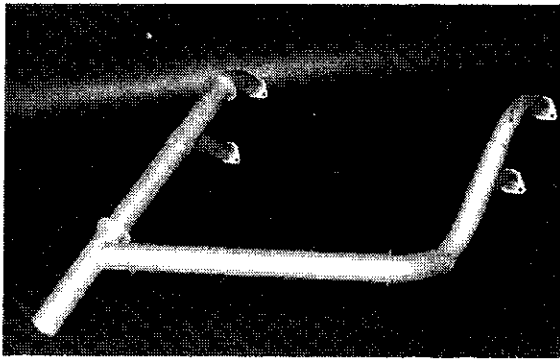

2590-2  
(2590-1 Tailpipe Opposite Side)

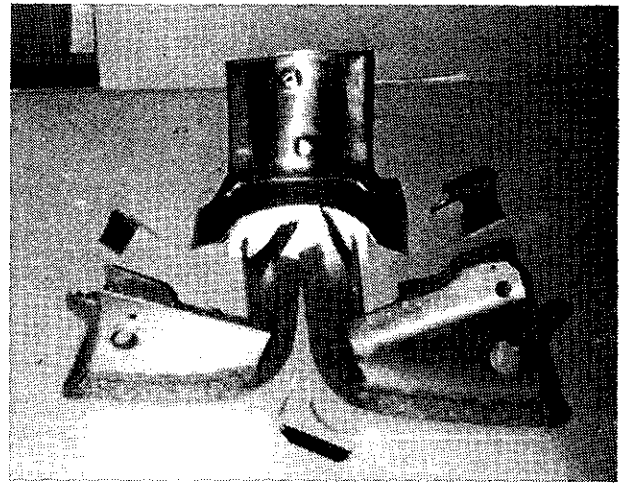

BC-L637,  
BC-L637-2 or BC-L637-3 (Including  
B-A6045, B-A6045-2 or  
B-A6045-4)

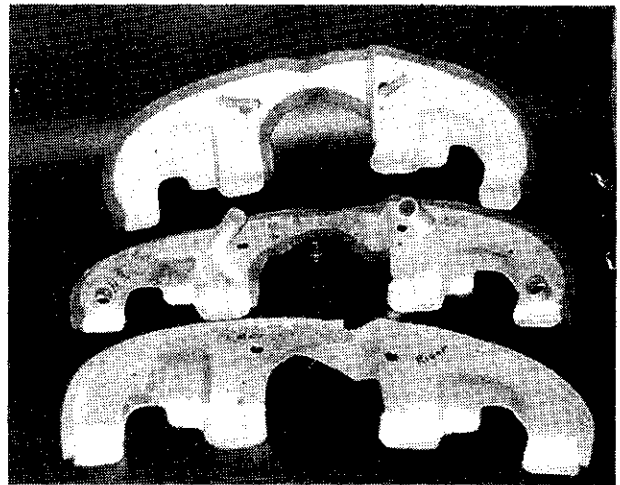
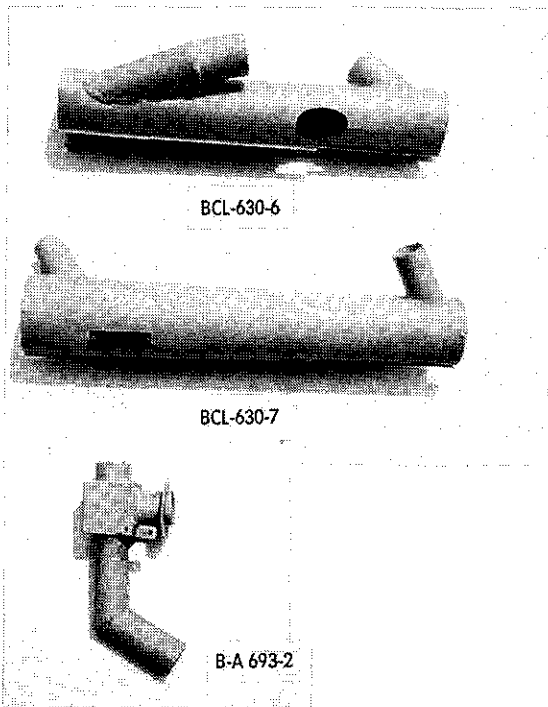

B-A6045  
B-A6045

B-A6045

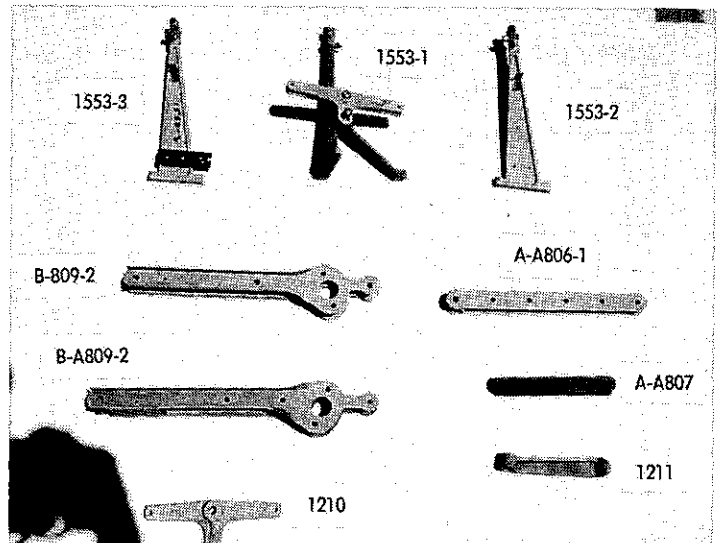
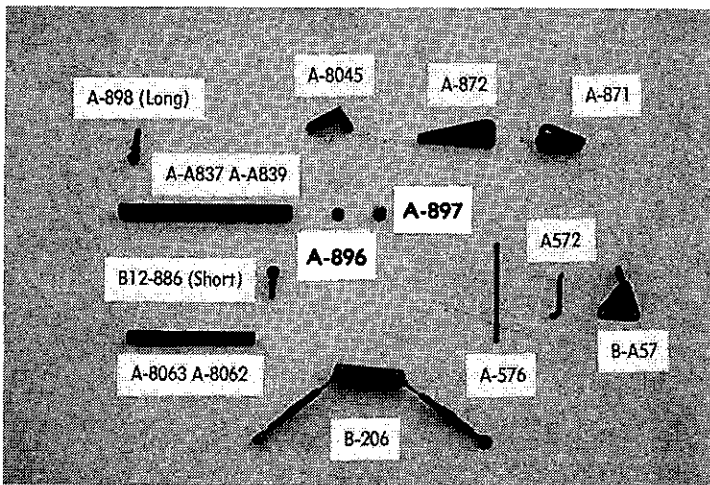

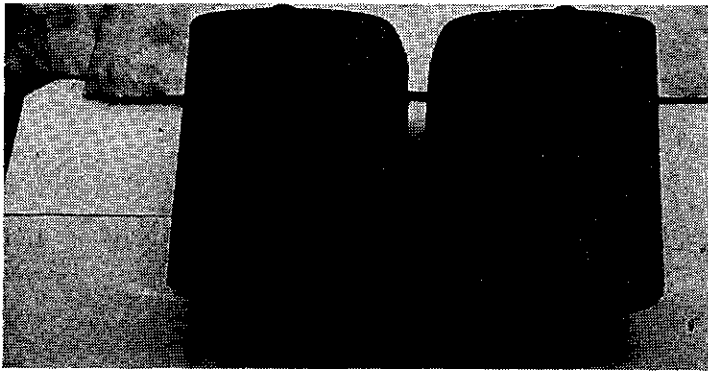

0797

0797-12

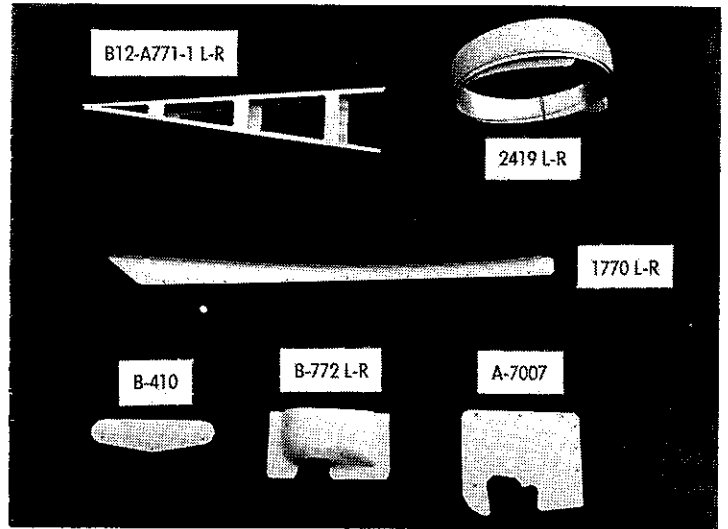

B12-A771-1 L-R

2419 L-R

1770 L-R

B-410

B-772 L-R

A-7007

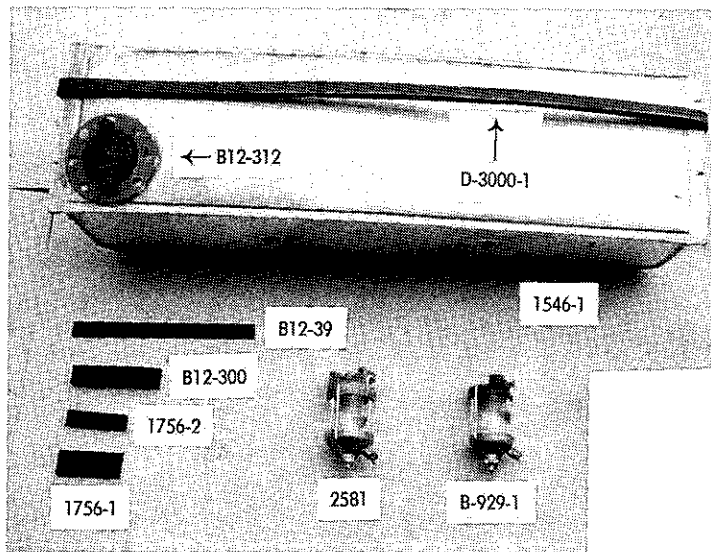

← B12-312

↑ D-3000-1

1546-1

B12-39

B12-300

1756-2

1756-1

2581

B-929-1

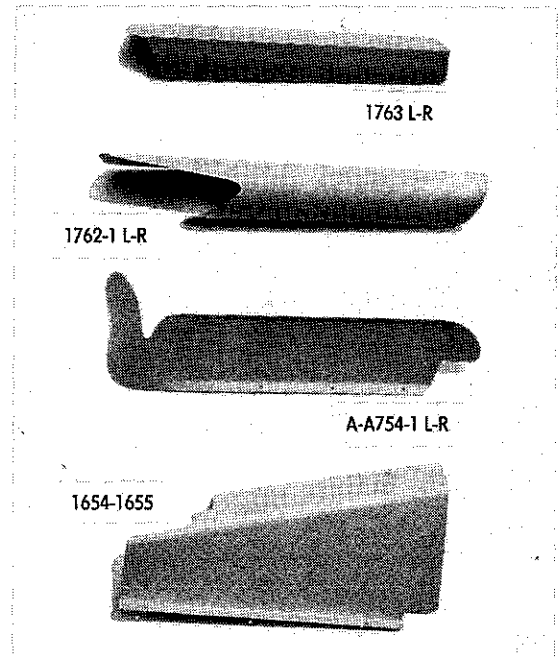

1763 L-R

1762-1 L-R

A-A754-1 L-R

1654-1655

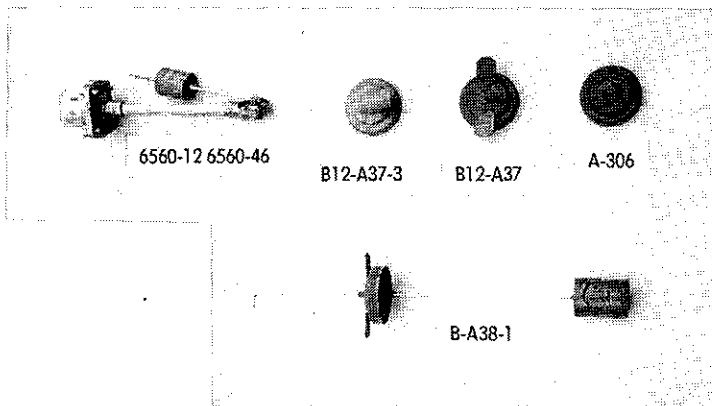

6560-12 6560-46

B12-A37-3

B12-A37

A-306

B-A38-1

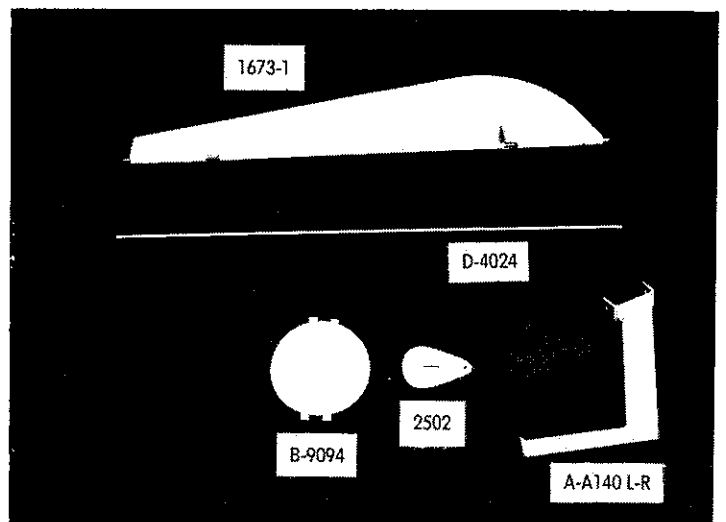

1673-1

D-4024

2502

B-9094

A-A140 L-R

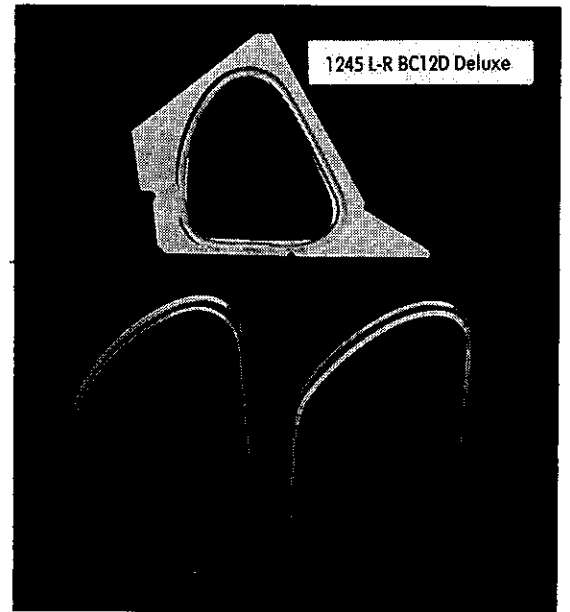
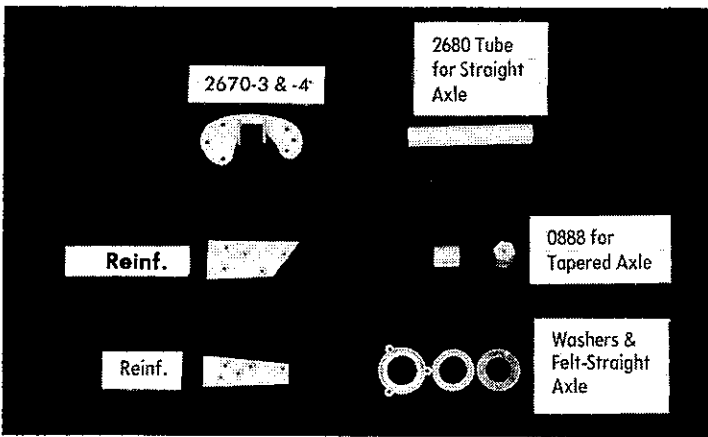
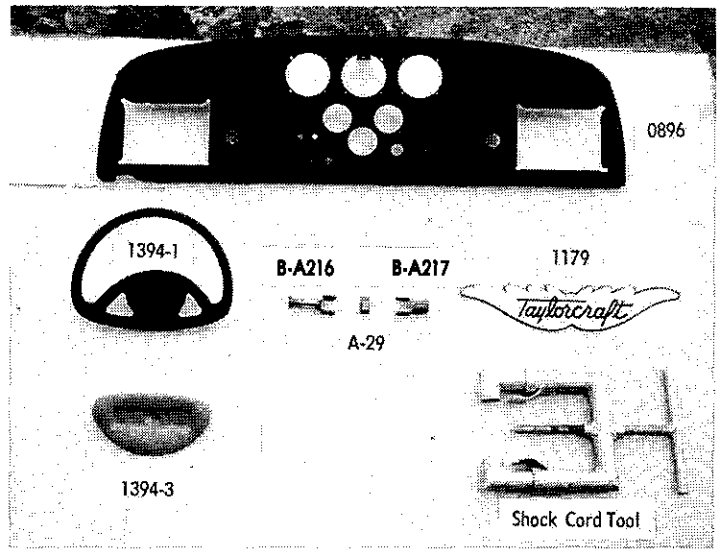
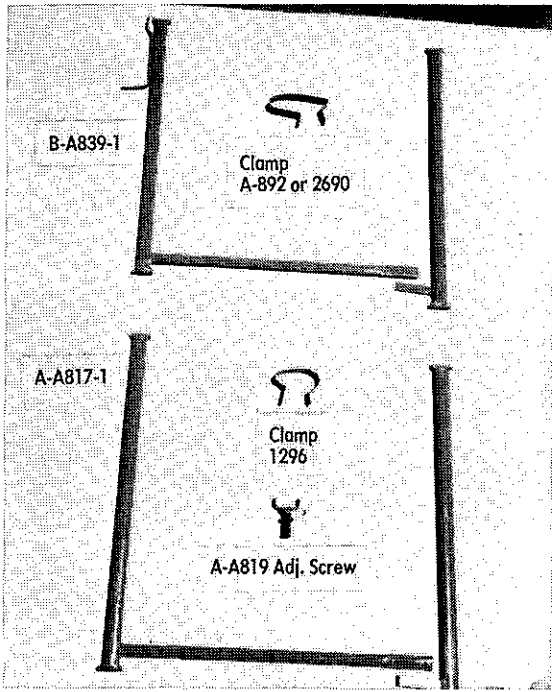

Wheel Pants Installation Kit Tapered & Straight Axle Mechanical Brakes

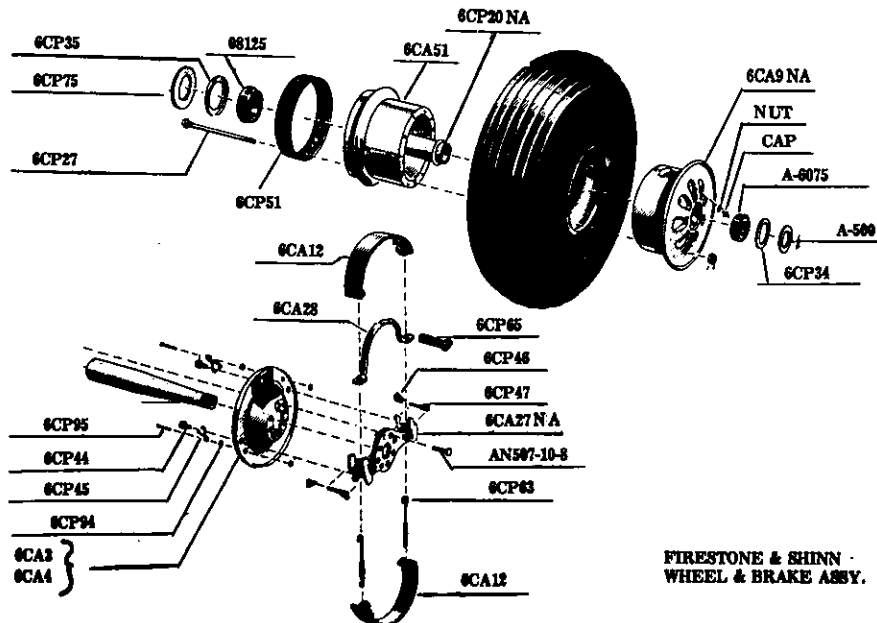

FIRESTONE & SHINN - WHEEL & BRAKE ASSY.

TAYLORCRAFT BC12D SERIES

LEFT WING PANEL WITH METAL STAMPED RIBS  
NOTE: FOR RIGHT PANEL CHANGE ALL L TO R

NOTE: THESE RIBS ARE INTERCHANGEABLE WITH  
OLD STYLE BUILT UP RIBS.

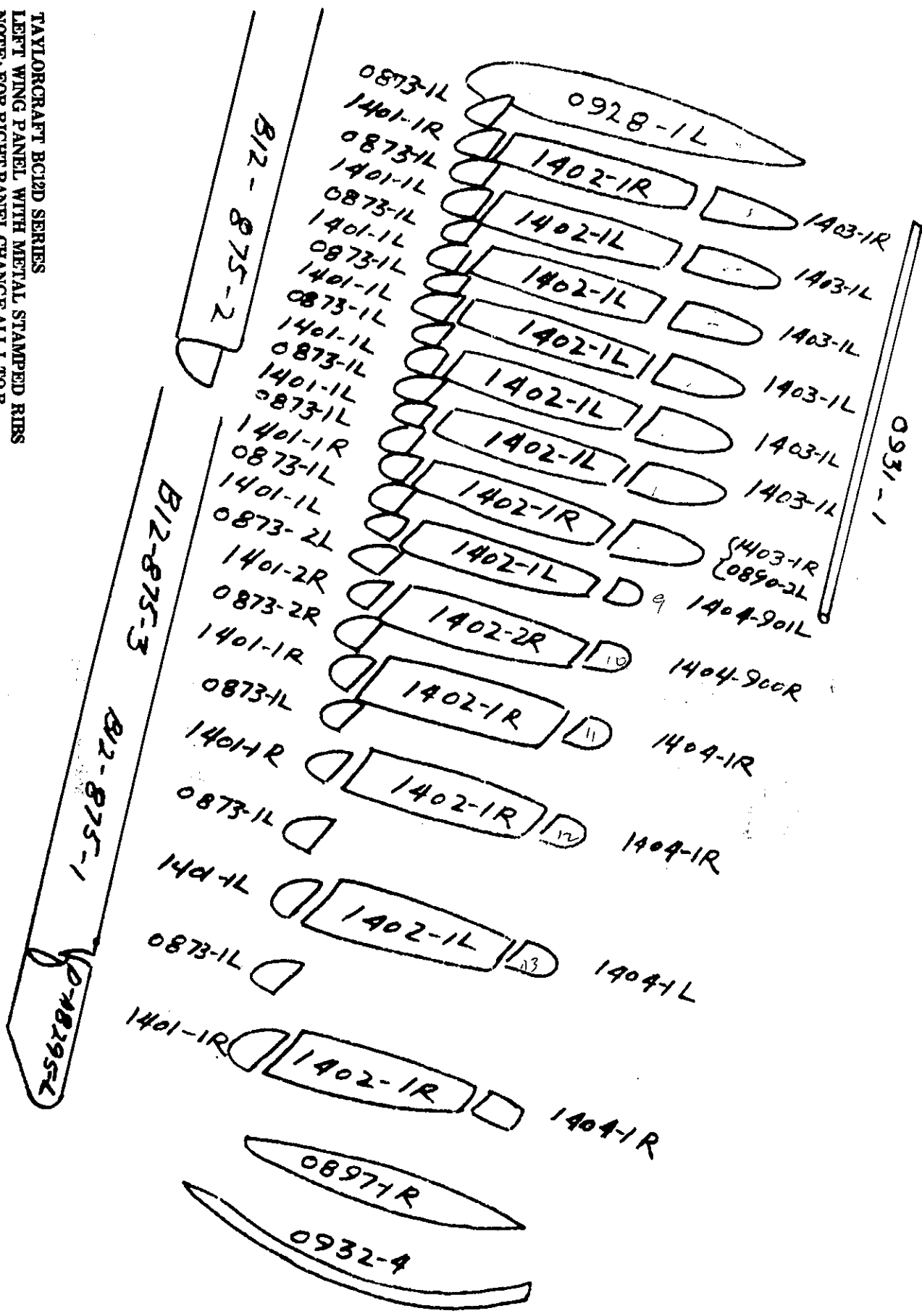

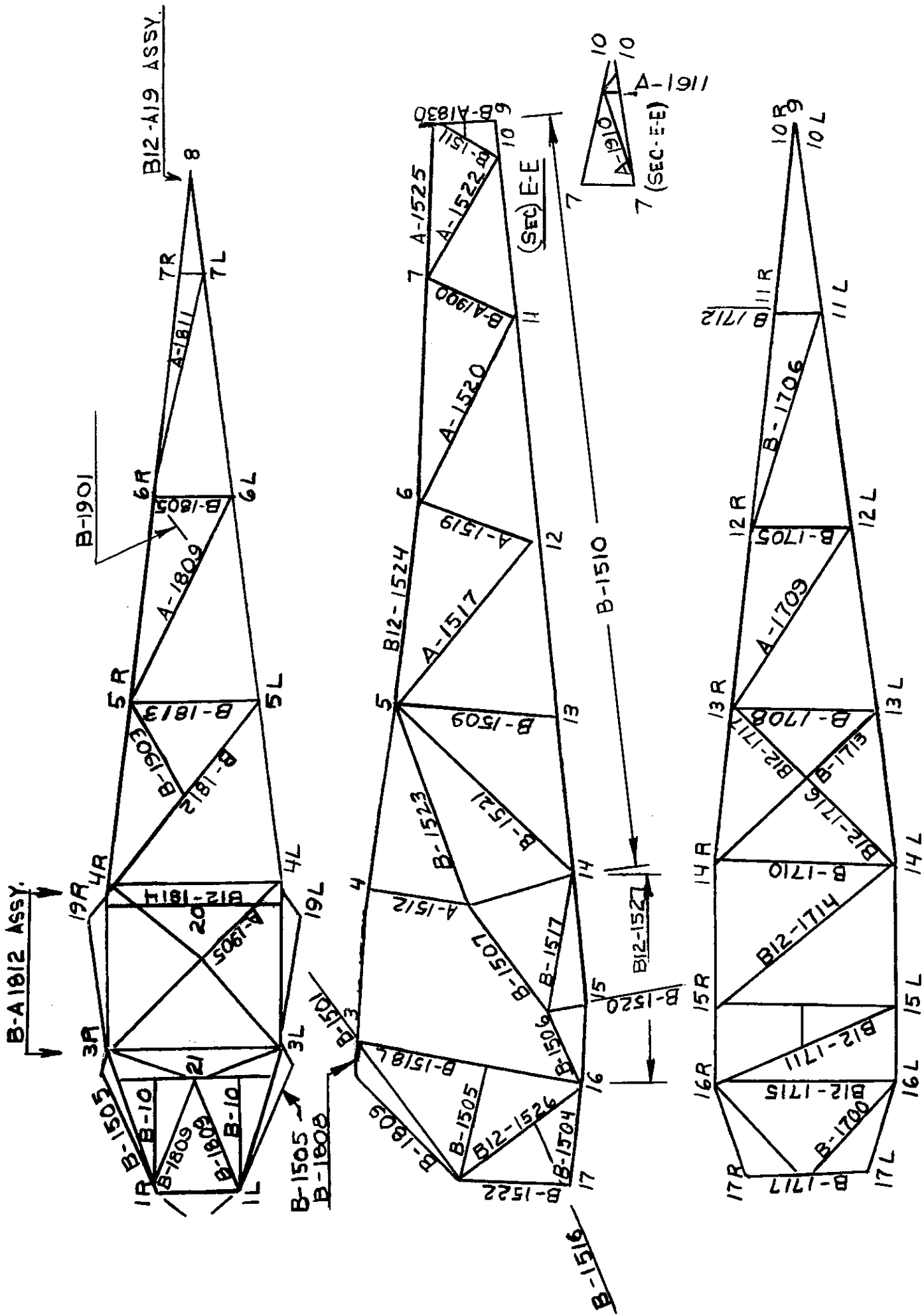



(SIDE VIEW)

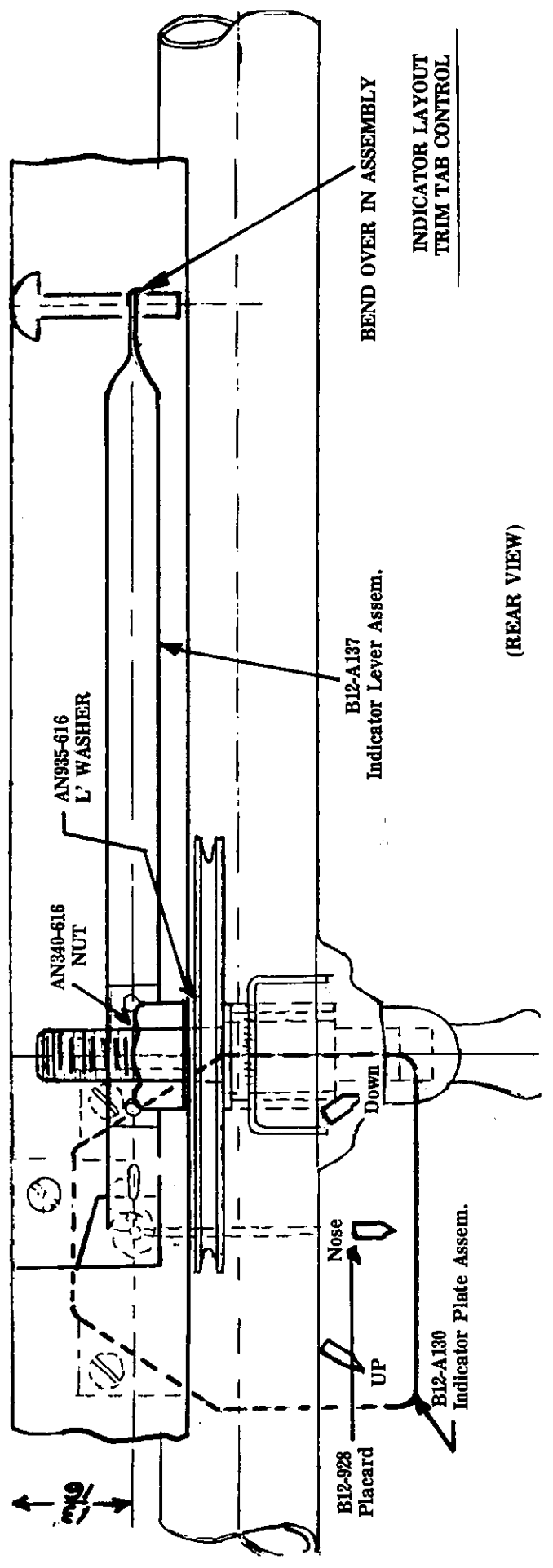
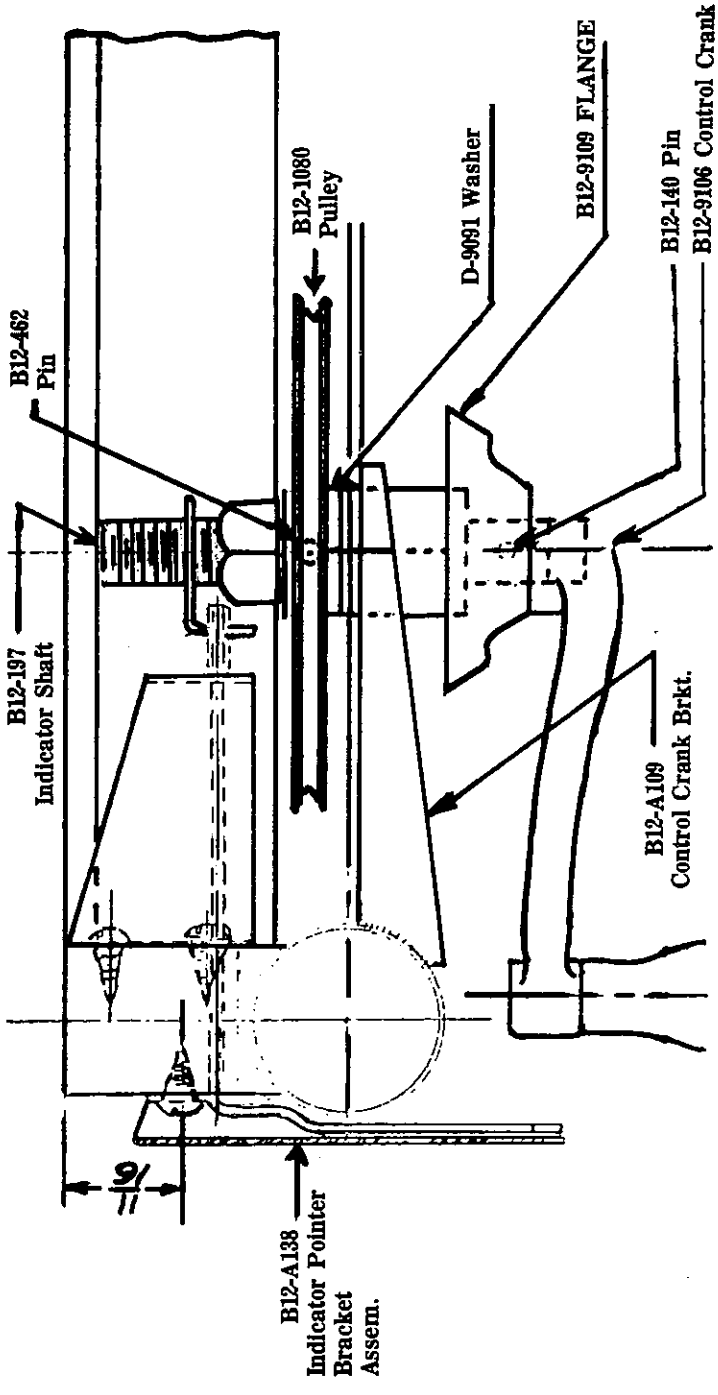

INDICATOR LAYOUT  
TRIM TAB CONTROL

(REAR VIEW)

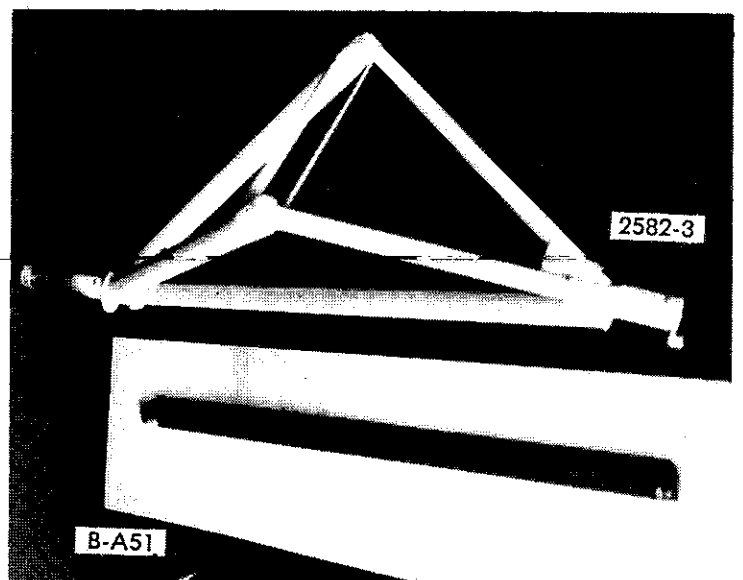
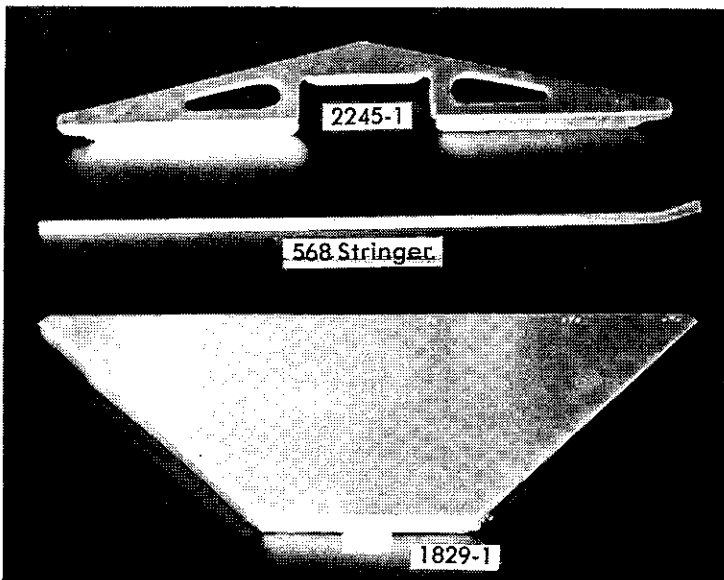
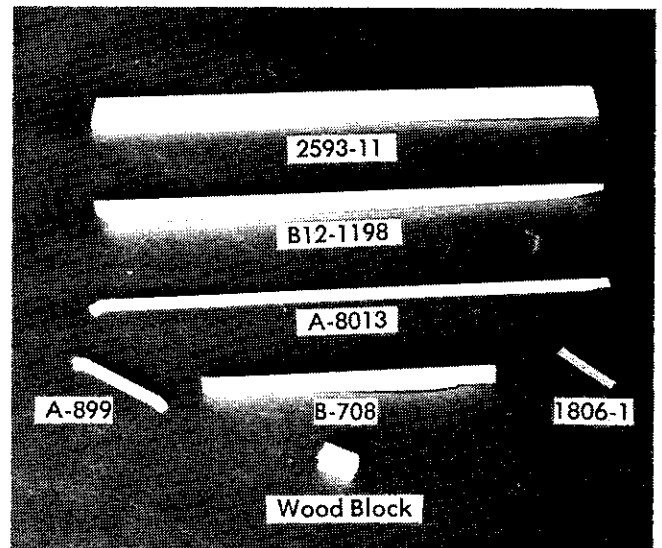
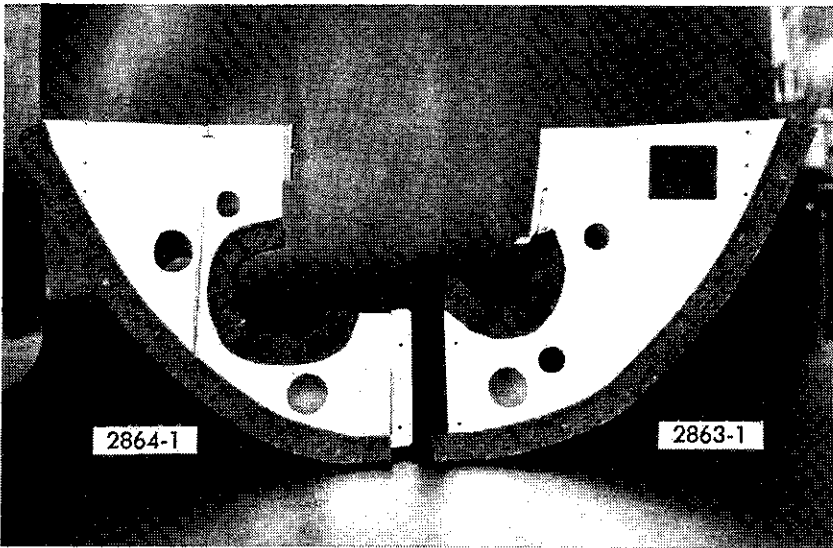
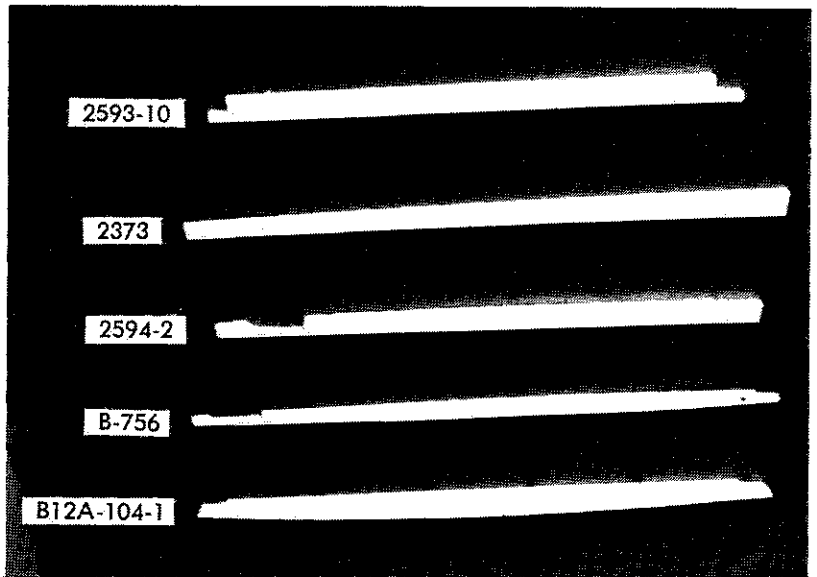
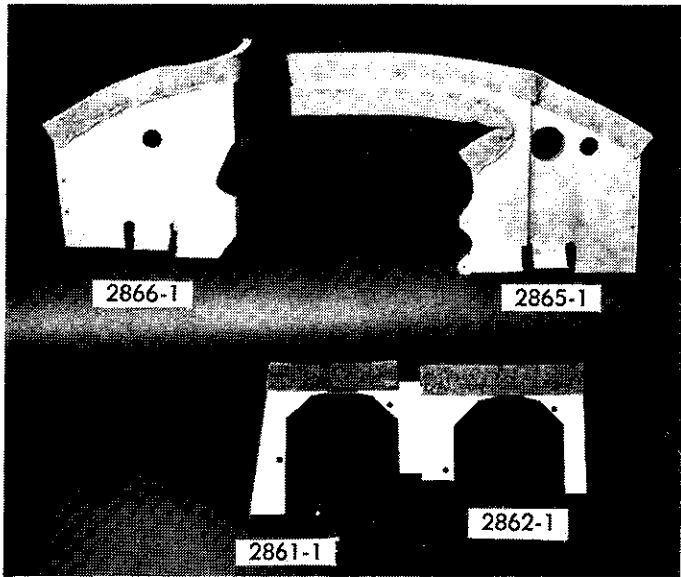

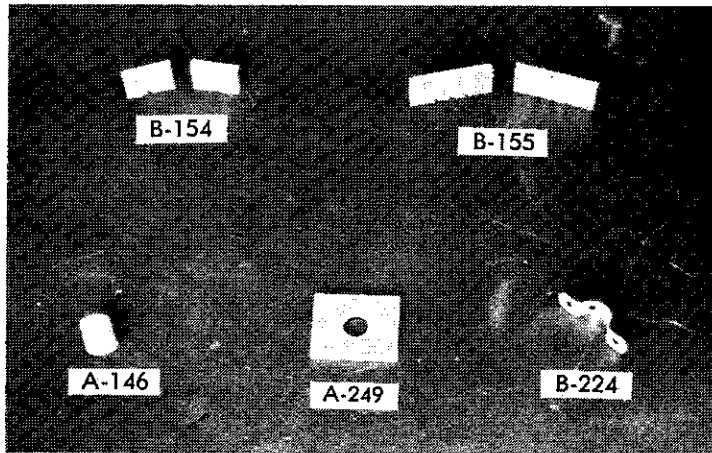
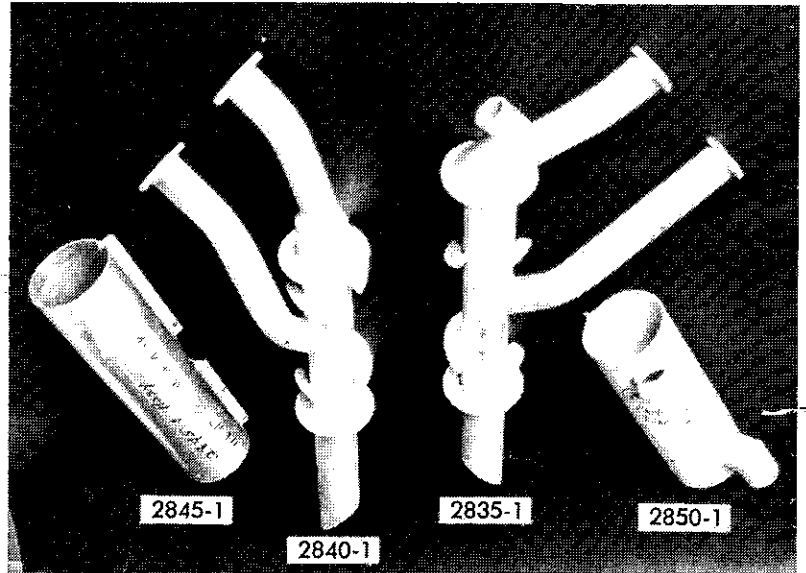
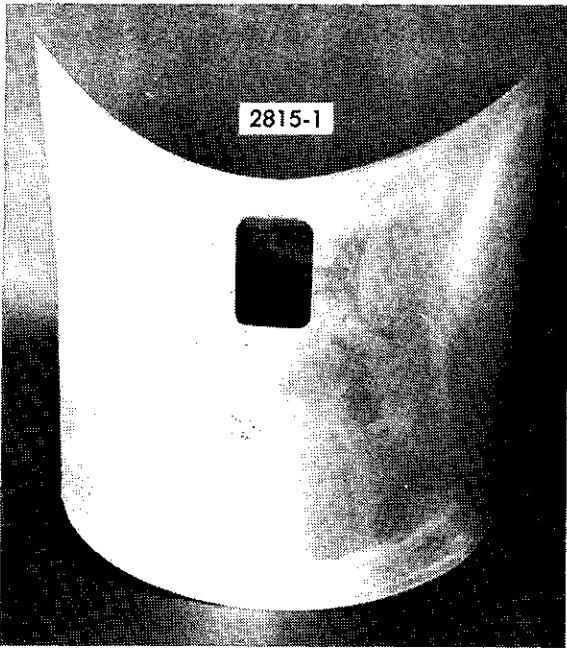
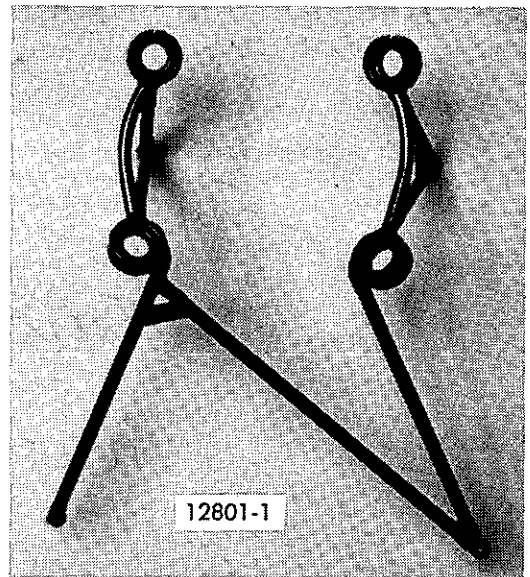
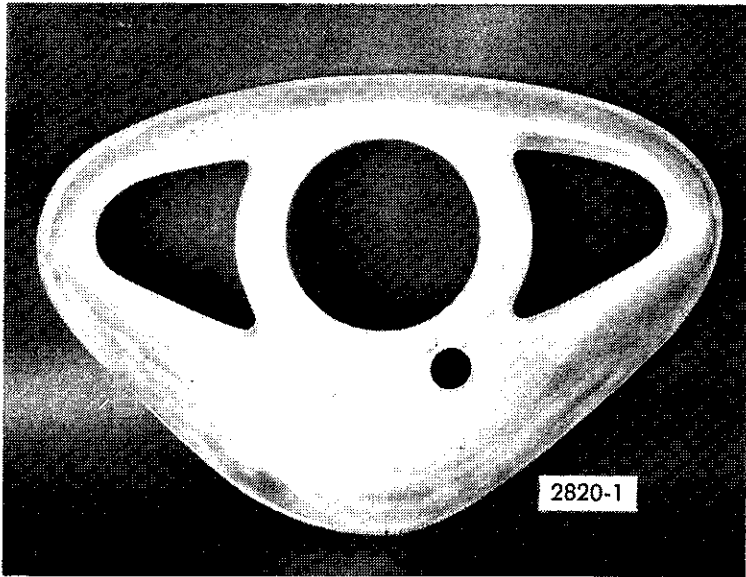

FAA / FSDO

150 FRED WEHRAN DRIVE

TETERBORO, N.J.

~~067~~

07608

MARK WITKOWSKI

Rec'd 6/7 ←

11