

YOU ROCK!

First, **THANK YOU** for purchasing this resource. I hope it makes your job as a classroom teacher easier and saves you tons of time.

Second, **YOU ARE AMAZING.**

Teaching is hard work. I can tell just by the fact that you downloaded this resource that you want to be the best you can be! **GO YOU!**

-Sara Marye



LOOKING FOR MORE **STELLAR** RESOURCES?

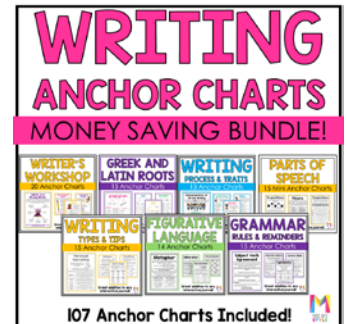
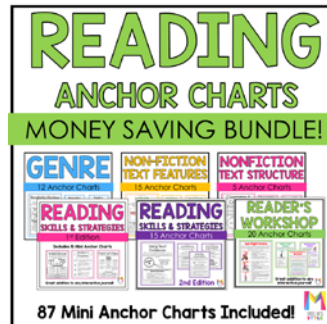
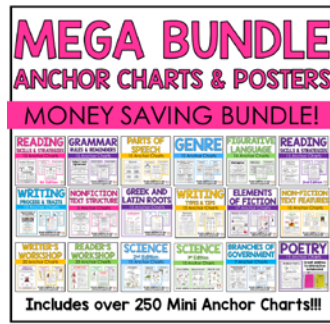

TOU - PLEASE **RESPECT** MY WORK

Every page of this document is copyright of Sara Marye, The Stellar Teacher Co. LLC. All Rights Reserved.

- This product is for personal use only and is to be used only by the purchaser/original downloader of the product.
- Copying this product for other teachers, your department, your school, your district, or your friends is prohibited.
- Teachers may NOT upload this product to school/district servers, or to any website, distribute via e-mail, or share digital or print copies including to file sharing sites.
- You do not have permission to claim any part of it as your own, to copy, or modify it, and you may not share or sell anything based on this document.

DO YOU HAVE A REQUEST?

It is my goal to make resources that you love and will make you a better teacher. Click [HERE](#) to let me know what you need.

A HUGE **THANKS** TO THESE FOLKS!

[Kimberly Geswein Fonts](#)



I'D LOVE TO **CONNECT!**

For real. Let's be friends. Click the icon below to follow me.



WWW.STELLARTEACHER.COM

DIRECTIONS

While this isn't entirely a no-prep TPT product, it is relatively simple to print the sticky notes. Once printed, students have a meaningful tool to help focus their stop-and-jot responses during independent reading.

Step 1: Print the reading response sticky note templates.

*Please note there are two pages that contain all 12 templates in a mixed format the rest of the pages contain one single template which allows you to print a specific skill in bulk.

Step 2: Place sticky notes on top of templates. Make sure the sticky note is completely inside the box and that you place the sticky part at the top.

Step 3: If you are using a printer, place all the templates (sticky notes attached) back in your feeder tray. Each printer is different. My personal printer requires me to put the stick-note-loaded-paper face down and top first. Pay attention to the specific settings.

Step 4: Once the paper is loaded in the printer, just re-print the template.

Step 1

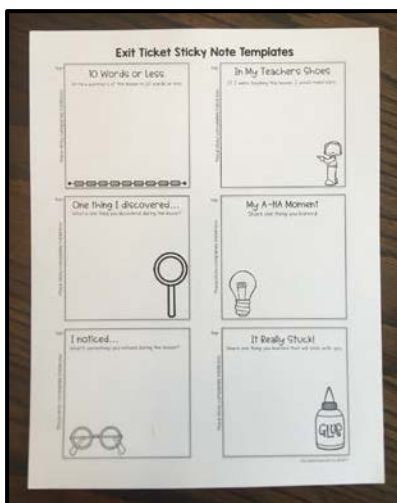

Step 2



Step 4

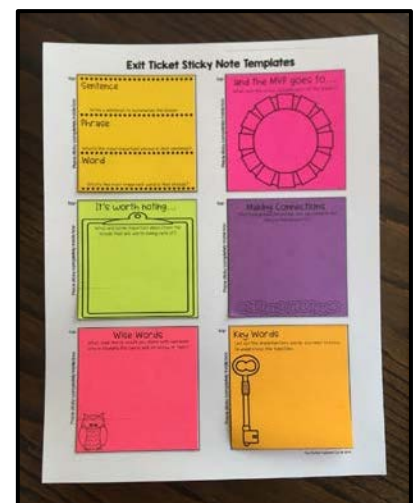

TEACHING TIPS



1. To help make this a “no-prep” resource for you (the teacher), train your students to load up the templates with sticky notes. This could become a weekly job and then all you have to do is press print.
2. Similarly to #1, get a parent volunteer to prepare all the sticky notes for you.
3. Print in bulk at the beginning of the year. Just store the sticky notes on the template to maximize the sticky part. You could create a file folder for each template and students can select which templates they want to use during independent reading time.
4. Print the mixed template pages for students at the beginning of the week. To ensure they are practicing ALL of their reading strategies, tell them they need to use all the stickys by the end of the week.
5. Once students have used the sticky notes in their independent reading, you could add them to an anchor chart as an example of how to apply that skill/strategy to reading.
6. The templates also work great if you just print them on colorful paper and cut them out. The small space is the perfect size for students to reflect on what they learned during the lesson.
7. You can glue all of the student response to an anchor chart as a way to document student learning.

Are you going digital?

You can download a digital version of this resource that is compatible with Google Slides

[CLICK HERE TO GRAB THE DIGITAL VERSION](#)



Exit Ticket Sticky Note Templates

top

What are three things you learned?

3

Place sticky completely inside box

What are two questions or wonderings you still have?

2

What is one thing you still need to practice?

1

top

My Top 5 List

If this lesson had a top 5 list, what would be on it?

5

4

3

2

1

top

The most important thing about _____ is...

Place sticky completely inside box



.....

top

Comment/Question

1 comment about the lesson	1 question I still have after the lesson

Place sticky completely inside box

top

Watermelon Idea

What is the big idea from the lesson?

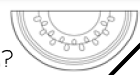

Place sticky completely inside box

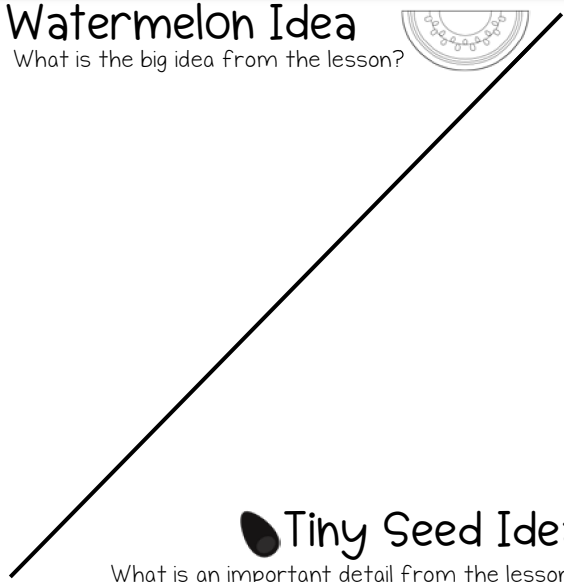

 **Tiny Seed Idea**

What is an important detail from the lesson? :

top

Tug-o-War

Do you agree or disagree with the statement your teacher gave? Check the box and explain in the space below.

I agree I disagree

Place sticky completely inside box



Exit Ticket Sticky Note Templates

top

10 Words or Less

Write a summary of the lesson in 10 words or less:

Place sticky completely inside box



top

In My Teacher's Shoes

If I were teaching this lesson, I would make sure...

Place sticky completely inside box



top

One thing I discovered...

What is one thing you discovered during the lesson?

Place sticky completely inside box



top

My A-HA Moment

Share one thing you learned.

Place sticky completely inside box



top

I noticed...

What's something you noticed during the lesson?

Place sticky completely inside box

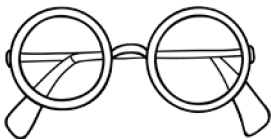

top

It Really Stuck!

Share one thing you learned that will stick with you.

Place sticky completely inside box



Exit Ticket Sticky Note Templates

top

#lessonslearned...

What are 3 hashtags would you use for this lesson?

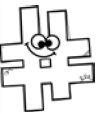

Place sticky completely inside box

top

What's a Picture Worth?

Draw a picture that is worth 1,000 words and communicates important ideas from the lesson.

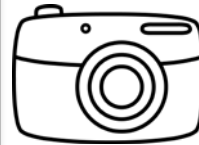

Place sticky completely inside box

top

What would you pack?

If you could just pack one idea from this lesson, what would it be?

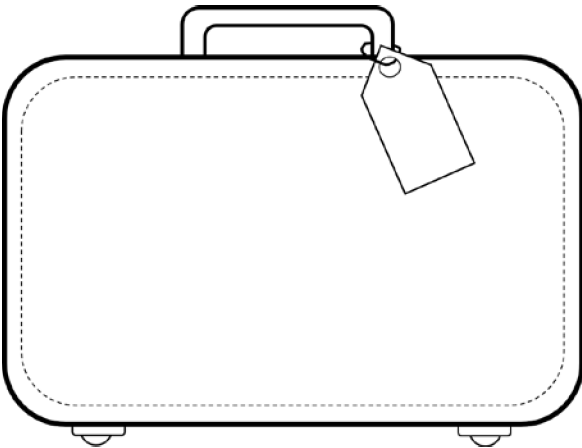

Place sticky completely inside box

top

Text me your takeaways

What is an important take away from the lesson?

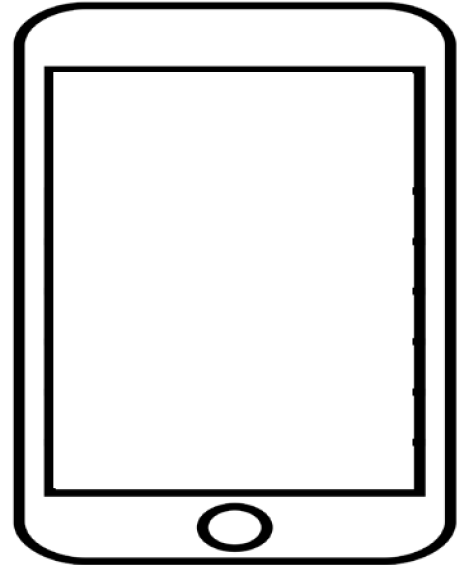

Place sticky completely inside box

top

BRAIN-DUMP

Write down everything you learned from the lesson.



Place sticky completely inside box

top

I used to think...

but now I think...

Place sticky completely inside box

Exit Ticket Sticky Note Templates

top

.....

Sentence

.....

Write a sentence to summarize the lesson.

.....

Phrase

.....

What's the most important phrase in that sentence?

.....

Word

.....

What's the most important word in that phrase?

.....

Place sticky completely inside box

top

and the MVP goes to...

What was the most valuable part of the lesson?

Place sticky completely inside box

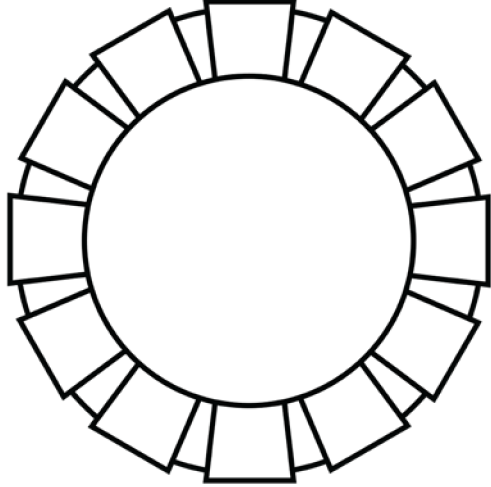

top

It's worth noting...

Place sticky completely inside box

What are some important ideas from the lesson that are worth taking note of?



top

Making Connections

What background knowledge can you connect the ideas in this lesson to?

Place sticky completely inside box



top

Wise Words

What wise words would you share with someone who is studying the same skill, strategy, or topic?

Place sticky completely inside box



top

Key Words

List out the important key words you need to know to understand this topic/idea.

Place sticky completely inside box

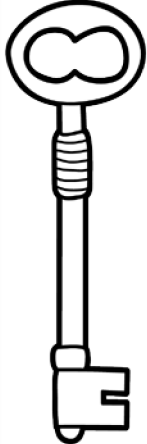

Exit Ticket Sticky Note Templates - 3-2-1

top

What are three things you learned?

3

Place sticky completely inside box

What are two questions or wonderings you still have?

2

What is one thing you still need to practice?

1

top

What are three things you learned?

3

Place sticky completely inside box

What are two questions or wonderings you still have?

2

What is one thing you still need to practice?

1

top

What are three things you learned?

3

Place sticky completely inside box

What are two questions or wonderings you still have?

2

What is one thing you still need to practice?

1

top

What are three things you learned?

3

Place sticky completely inside box

What are two questions or wonderings you still have?

2

What is one thing you still need to practice?

1

top

What are three things you learned?

3

Place sticky completely inside box

What are two questions or wonderings you still have?

2

What is one thing you still need to practice?

1

top

What are three things you learned?

3

Place sticky completely inside box

What are two questions or wonderings you still have?

2

What is one thing you still need to practice?

1

Exit Ticket Sticky Note Templates - My Top 5 List

top

My Top 5 List

5

4

3

2

1

Place sticky completely inside box

top

My Top 5 List

5

4

3

2

1

Place sticky completely inside box

top

My Top 5 List

5

4

3

2

1

Place sticky completely inside box

top

My Top 5 List

5

4

3

2

1

Place sticky completely inside box

top

My Top 5 List

5

4

3

2

1

Place sticky completely inside box

top

My Top 5 List

5

4

3

2

1

Place sticky completely inside box

Exit Ticket Sticky Note Templates - Most Important Thing

top

The most important thing about _____ is...

Place sticky completely inside box



.....

top

The most important thing about _____ is...

Place sticky completely inside box



.....

top

The most important thing about _____ is...

Place sticky completely inside box



.....

top

The most important thing about _____ is...

Place sticky completely inside box



.....

top

The most important thing about _____ is...

Place sticky completely inside box



.....

top

The most important thing about _____ is...

Place sticky completely inside box



.....

Exit Ticket Sticky Note Templates - Comment & Question

top

Comment/Question

1 comment about the lesson	1 question I still have after the lesson

Place sticky completely inside box

top

Comment/Question

1 comment about the lesson	1 question I still have after the lesson

Place sticky completely inside box

top

Comment/Question

1 comment about the lesson	1 question I still have after the lesson

Place sticky completely inside box

top

Comment/Question

1 comment about the lesson	1 question I still have after the lesson

Place sticky completely inside box

top

Comment/Question

1 comment about the lesson	1 question I still have after the lesson

Place sticky completely inside box

top

Comment/Question

1 comment about the lesson	1 question I still have after the lesson

Place sticky completely inside box

Exit Ticket Sticky Note Templates - Seed Idea

top

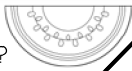
Watermelon Idea 

What is the big idea from the lesson?

Place sticky completely inside box

 Tiny Seed Idea

What is an important detail from the lesson:?

top

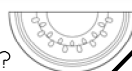
Watermelon Idea 

What is the big idea from the lesson?

Place sticky completely inside box

 Tiny Seed Idea

What is an important detail from the lesson:?

top

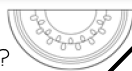
Watermelon Idea 

What is the big idea from the lesson?

Place sticky completely inside box

 Tiny Seed Idea

What is an important detail from the lesson:?

top

Watermelon Idea 

What is the big idea from the lesson?

Place sticky completely inside box

 Tiny Seed Idea

What is an important detail from the lesson:?

top

Watermelon Idea 

What is the big idea from the lesson?

Place sticky completely inside box

 Tiny Seed Idea

What is an important detail from the lesson:?

top

Watermelon Idea 

What is the big idea from the lesson?

Place sticky completely inside box

 Tiny Seed Idea

What is an important detail from the lesson:?

Exit Ticket Sticky Note Templates - Tug-O-War

top

Tug-o-War

Do you agree or disagree with the statement your teacher gave? Check the box and explain in the space

I agree below. I disagree

Place sticky completely inside box

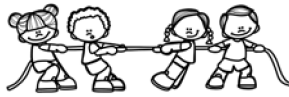

top

Tug-o-War

Do you agree or disagree with the statement your teacher gave? Check the box and explain in the space

I agree below. I disagree

Place sticky completely inside box



top

Tug-o-War

Do you agree or disagree with the statement your teacher gave? Check the box and explain in the space

I agree below. I disagree

Place sticky completely inside box

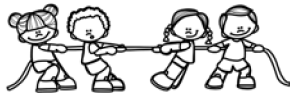

top

Tug-o-War

Do you agree or disagree with the statement your teacher gave? Check the box and explain in the space

I agree below. I disagree

Place sticky completely inside box



top

Tug-o-War

Do you agree or disagree with the statement your teacher gave? Check the box and explain in the space

I agree below. I disagree

Place sticky completely inside box

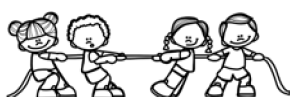

top

Tug-o-War

Do you agree or disagree with the statement your teacher gave? Check the box and explain in the space

I agree below. I disagree

Place sticky completely inside box

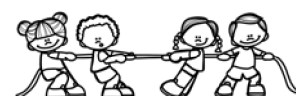

Exit Ticket Sticky Note Templates - Draw Label Caption

top

Draw. Label. Caption.

Place sticky completely inside box

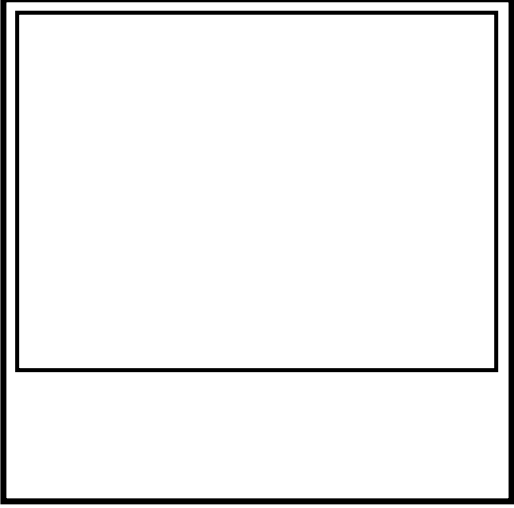
A rectangular sticky note template. At the top, the text "Draw. Label. Caption." is written in a simple font. Below the text is a large, empty rectangular box with a double-line border, intended for drawing. At the bottom of the sticky note, there is a horizontal line, creating a space for a caption.

top

Draw. Label. Caption.

Place sticky completely inside box

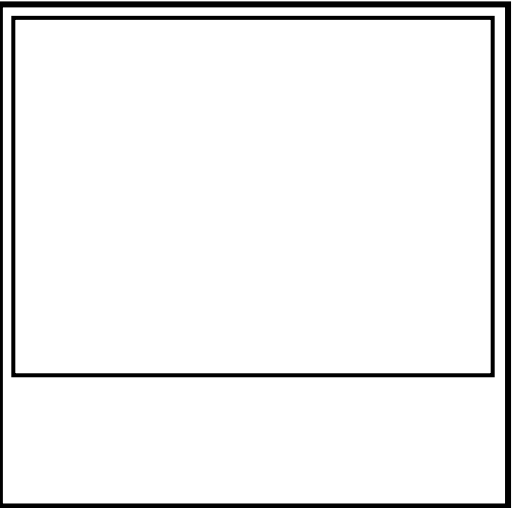
A rectangular sticky note template. At the top, the text "Draw. Label. Caption." is written in a simple font. Below the text is a large, empty rectangular box with a double-line border, intended for drawing. At the bottom of the sticky note, there is a horizontal line, creating a space for a caption.

top

Draw. Label. Caption.

Place sticky completely inside box

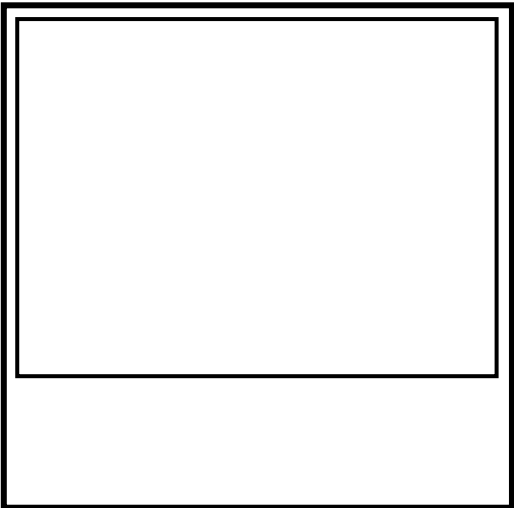
A rectangular sticky note template. At the top, the text "Draw. Label. Caption." is written in a simple font. Below the text is a large, empty rectangular box with a double-line border, intended for drawing. At the bottom of the sticky note, there is a horizontal line, creating a space for a caption.

top

Draw. Label. Caption.

Place sticky completely inside box

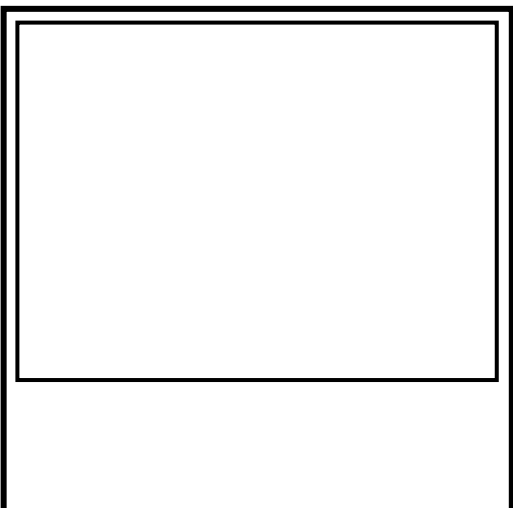
A rectangular sticky note template. At the top, the text "Draw. Label. Caption." is written in a simple font. Below the text is a large, empty rectangular box with a double-line border, intended for drawing. At the bottom of the sticky note, there is a horizontal line, creating a space for a caption.

top

Draw. Label. Caption.

Place sticky completely inside box

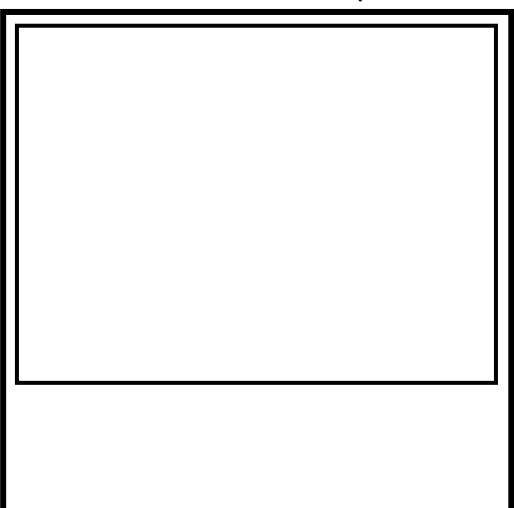
A rectangular sticky note template. At the top, the text "Draw. Label. Caption." is written in a simple font. Below the text is a large, empty rectangular box with a double-line border, intended for drawing. At the bottom of the sticky note, there is a horizontal line, creating a space for a caption.

top

Draw. Label. Caption.

Place sticky completely inside box

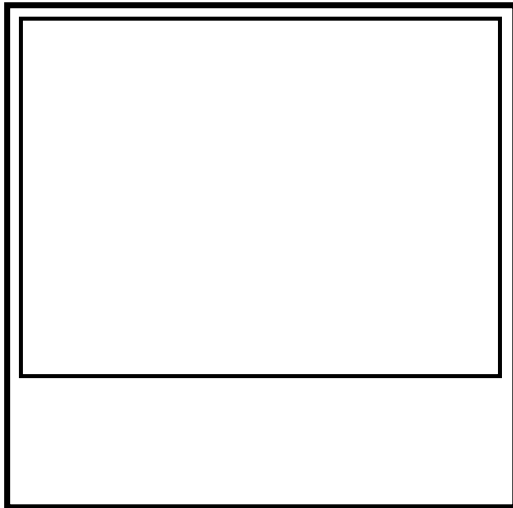
A rectangular sticky note template. At the top, the text "Draw. Label. Caption." is written in a simple font. Below the text is a large, empty rectangular box with a double-line border, intended for drawing. At the bottom of the sticky note, there is a horizontal line, creating a space for a caption.

Exit Ticket Sticky Note Templates - Stoplight

top

Stop, Slow, or Ready to Go?

What's your level of understanding? Do you need to stop and start over? Do you just need to go slow? Are you ready to go to the next lesson? Explain your choice.

Place sticky completely inside box

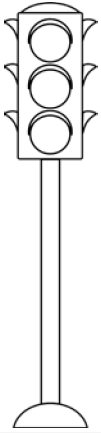

top

Stop, Slow, or Ready to Go?

What's your level of understanding? Do you need to stop and start over? Do you just need to go slow? Are you ready to go to the next lesson? Explain your choice.

Place sticky completely inside box

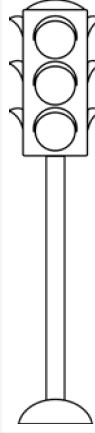

top

Stop, Slow, or Ready to Go?

What's your level of understanding? Do you need to stop and start over? Do you just need to go slow? Are you ready to go to the next lesson? Explain your choice.

Place sticky completely inside box

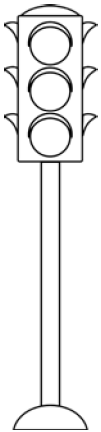

top

Stop, Slow, or Ready to Go?

What's your level of understanding? Do you need to stop and start over? Do you just need to go slow? Are you ready to go to the next lesson? Explain your choice.

Place sticky completely inside box

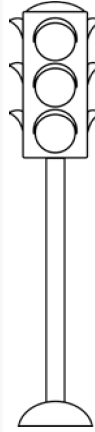

top

Stop, Slow, or Ready to Go?

What's your level of understanding? Do you need to stop and start over? Do you just need to go slow? Are you ready to go to the next lesson? Explain your choice.

Place sticky completely inside box

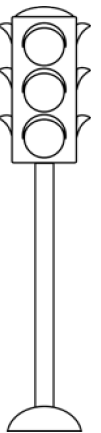

top

Stop, Slow, or Ready to Go?

What's your level of understanding? Do you need to stop and start over? Do you just need to go slow? Are you ready to go to the next lesson? Explain your choice.

Place sticky completely inside box

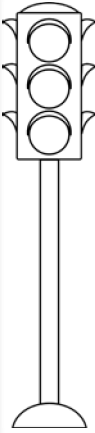

Exit Ticket Sticky Note Templates - Extra! Extra!

top

Extra! Extra! Read All About It!

If this lesson had a headline in a local newspaper,
what would it be?

Place sticky completely inside box



top

Extra! Extra! Read All About It!

If this lesson had a headline in a local newspaper,
what would it be?

Place sticky completely inside box



top

Extra! Extra! Read All About It!

If this lesson had a headline in a local newspaper,
what would it be?

Place sticky completely inside box



top

Extra! Extra! Read All About It!

If this lesson had a headline in a local newspaper,
what would it be?

Place sticky completely inside box



top

Extra! Extra! Read All About It!

If this lesson had a headline in a local newspaper,
what would it be?

Place sticky completely inside box



top

Extra! Extra! Read All About It!

If this lesson had a headline in a local newspaper,
what would it be?

Place sticky completely inside box



Exit Ticket Sticky Note Templates - Rate Your Learning

top

Check For Understanding

Rate your understanding of the lesson. Explain.

Place sticky completely inside box



top

Check For Understanding

Rate your understanding of the lesson. Explain.

Place sticky completely inside box



top

Check For Understanding

Rate your understanding of the lesson. Explain.

Place sticky completely inside box



top

Check For Understanding

Rate your understanding of the lesson. Explain.

Place sticky completely inside box



top

Check For Understanding

Rate your understanding of the lesson. Explain.

Place sticky completely inside box



top

Check For Understanding

Rate your understanding of the lesson. Explain.

Place sticky completely inside box



Exit Ticket Sticky Note Templates - Multiple Choice

top

Multiple Choice
Write a multiple choice question to go with the lesson.

Question:

A.	B.
C.	D.

Place sticky completely inside box

top

Multiple Choice
Write a multiple choice question to go with the lesson.

Question:

A.	B.
C.	D.

Place sticky completely inside box

top

Multiple Choice
Write a multiple choice question to go with the lesson.

Question:

A.	B.
C.	D.

Place sticky completely inside box

top

Multiple Choice
Write a multiple choice question to go with the lesson.

Question:

A.	B.
C.	D.

Place sticky completely inside box

top

Multiple Choice
Write a multiple choice question to go with the lesson.

Question:

A.	B.
C.	D.

Place sticky completely inside box

top

Multiple Choice
Write a multiple choice question to go with the lesson.

Question:

A.	B.
C.	D.

Place sticky completely inside box

Exit Ticket Sticky Note Templates - True or False

top

True or False

Write a true or false question for the lesson. Try to think of how you can make it tricky.

Question:

True False

Place sticky completely inside box

top

True or False

Write a true or false question for the lesson. Try to think of how you can make it tricky.

Question:

True False

Place sticky completely inside box

top

True or False

Write a true or false question for the lesson. Try to think of how you can make it tricky.

Question:

True False

Place sticky completely inside box

top

True or False

Write a true or false question for the lesson. Try to think of how you can make it tricky.

Question:

True False

Place sticky completely inside box

top

True or False

Write a true or false question for the lesson. Try to think of how you can make it tricky.

Question:

True False

Place sticky completely inside box

top

True or False

Write a true or false question for the lesson. Try to think of how you can make it tricky.

Question:

True False

Place sticky completely inside box

Exit Ticket Sticky Note Templates - 10 Words or Less

top

10 Words or Less

Write a summary of the lesson in 10 words or less:

Place sticky completely inside box



top

10 Words or Less

Write a summary of the lesson in 10 words or less:

Place sticky completely inside box



top

10 Words or Less

Write a summary of the lesson in 10 words or less:

Place sticky completely inside box



top

10 Words or Less

Write a summary of the lesson in 10 words or less:

Place sticky completely inside box



top

10 Words or Less

Write a summary of the lesson in 10 words or less:

Place sticky completely inside box



top

10 Words or Less

Write a summary of the lesson in 10 words or less:

Place sticky completely inside box



Exit Ticket Sticky Note Templates - In My Teacher's Shoes

top

In My Teacher's Shoes

If I were teaching this lesson, I would make sure...

Place sticky completely inside box



top

In My Teacher's Shoes

If I were teaching this lesson, I would make sure...

Place sticky completely inside box



top

In My Teacher's Shoes

If I were teaching this lesson, I would make sure...

Place sticky completely inside box



top

In My Teacher's Shoes

If I were teaching this lesson, I would make sure...

Place sticky completely inside box



top

In My Teacher's Shoes

If I were teaching this lesson, I would make sure...

Place sticky completely inside box



top

In My Teacher's Shoes

If I were teaching this lesson, I would make sure...

Place sticky completely inside box



Exit Ticket Sticky Note Templates - One Thing I Discovered

top

One thing I discovered...

What is one thing you discovered during the lesson?

Place sticky completely inside box



top

One thing I discovered...

What is one thing you discovered during the lesson?

Place sticky completely inside box



top

One thing I discovered...

What is one thing you discovered during the lesson?

Place sticky completely inside box



top

One thing I discovered...

What is one thing you discovered during the lesson?

Place sticky completely inside box



top

One thing I discovered...

What is one thing you discovered during the lesson?

Place sticky completely inside box



top

One thing I discovered...

What is one thing you discovered during the lesson?

Place sticky completely inside box

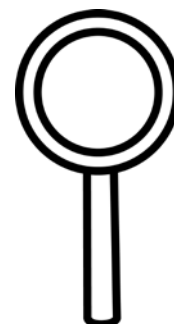

Exit Ticket Sticky Note Templates - My A-HA Moment

top

My A-HA Moment

Share one thing you learned.

Place sticky completely inside box



top

My A-HA Moment

Share one thing you learned.

Place sticky completely inside box



top

My A-HA Moment

Share one thing you learned.

Place sticky completely inside box



top

My A-HA Moment

Share one thing you learned.

Place sticky completely inside box



top

My A-HA Moment

Share one thing you learned.

Place sticky completely inside box



top

My A-HA Moment

Share one thing you learned.

Place sticky completely inside box



Exit Ticket Sticky Note Templates - I noticed...

top

I noticed...

What's something you noticed during the lesson?

Place sticky completely inside box

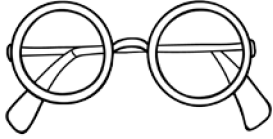

top

I noticed...

What's something you noticed during the lesson?

Place sticky completely inside box

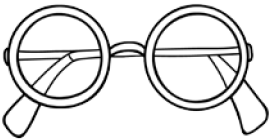

top

I noticed...

What's something you noticed during the lesson?

Place sticky completely inside box

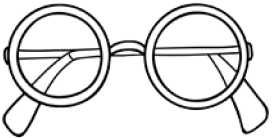

top

I noticed...

What's something you noticed during the lesson?

Place sticky completely inside box



top

I noticed...

What's something you noticed during the lesson?

Place sticky completely inside box

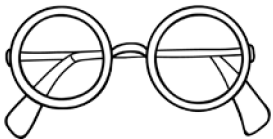

top

I noticed...

What's something you noticed during the lesson?

Place sticky completely inside box



Exit Ticket Sticky Note Templates - It Really Stuck!

top

It Really Stuck!

Share one thing you learned that will stick with you.

Place sticky completely inside box



top

It Really Stuck!

Share one thing you learned that will stick with you.

Place sticky completely inside box



top

It Really Stuck!

Share one thing you learned that will stick with you.

Place sticky completely inside box



top

It Really Stuck!

Share one thing you learned that will stick with you.

Place sticky completely inside box



top

It Really Stuck!

Share one thing you learned that will stick with you.

Place sticky completely inside box



top

It Really Stuck!

Share one thing you learned that will stick with you.

Place sticky completely inside box



Exit Ticket Sticky Note Templates - #lessonslearned

top

#lessonslearned...

What are 3 hashtags would you use for this lesson?

Place sticky completely inside box



top

#lessonslearned...

What are 3 hashtags would you use for this lesson?

Place sticky completely inside box



top

#lessonslearned...

What are 3 hashtags would you use for this lesson?

Place sticky completely inside box



top

#lessonslearned...

What are 3 hashtags would you use for this lesson?

Place sticky completely inside box



top

#lessonslearned...

What are 3 hashtags would you use for this lesson?

Place sticky completely inside box

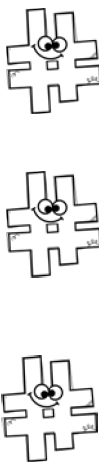

top

#lessonslearned...

What are 3 hashtags would you use for this lesson?

Place sticky completely inside box

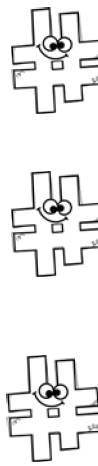

Exit Ticket Sticky Note Templates - What's a Picture Worth?

top

What's a Picture Worth?

Draw a picture that is worth 1,000 words and communicates important ideas from the lesson.

Place sticky completely inside box

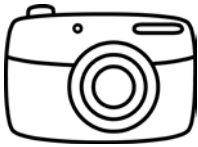

top

What's a Picture Worth?

Draw a picture that is worth 1,000 words and communicates important ideas from the lesson.

Place sticky completely inside box

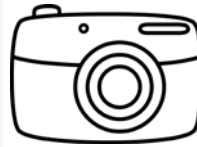

top

What's a Picture Worth?

Draw a picture that is worth 1,000 words and communicates important ideas from the lesson.

Place sticky completely inside box

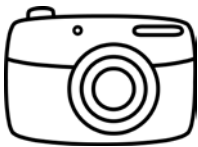

top

What's a Picture Worth?

Draw a picture that is worth 1,000 words and communicates important ideas from the lesson.

Place sticky completely inside box

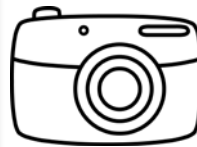

top

What's a Picture Worth?

Draw a picture that is worth 1,000 words and communicates important ideas from the lesson.

Place sticky completely inside box

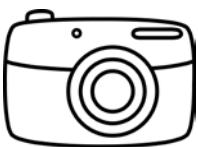

top

What's a Picture Worth?

Draw a picture that is worth 1,000 words and communicates important ideas from the lesson.

Place sticky completely inside box

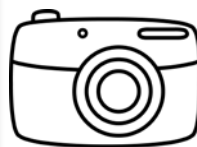

Exit Ticket Sticky Note Templates - Packing List

top

What would you pack?
If you could just pack one idea from this lesson,
what would it be?

Place sticky completely inside box

top

What would you pack?
If you could just pack one idea from this lesson,
what would it be?

Place sticky completely inside box

top

What would you pack?
If you could just pack one idea from this lesson,
what would it be?

Place sticky completely inside box

top

What would you pack?
If you could just pack one idea from this lesson,
what would it be?

Place sticky completely inside box

top

What would you pack?
If you could just pack one idea from this lesson,
what would it be?

Place sticky completely inside box

top

What would you pack?
If you could just pack one idea from this lesson,
what would it be?

Place sticky completely inside box

Exit Ticket Sticky Note Templates - Texting Takeaways

top

Place sticky completely inside box

Text me your takeaways
What is an important take away from the lesson?

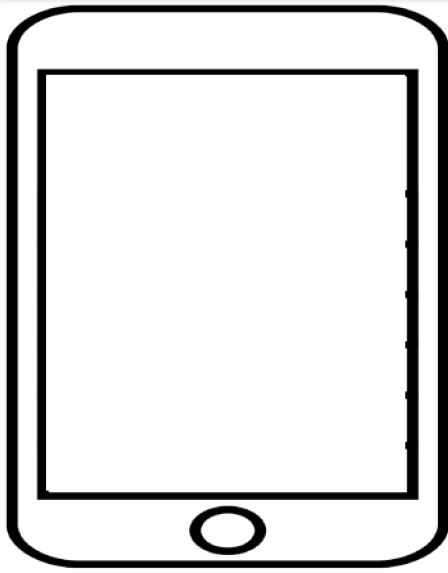

top

Place sticky completely inside box

Text me your takeaways
What is an important take away from the lesson?

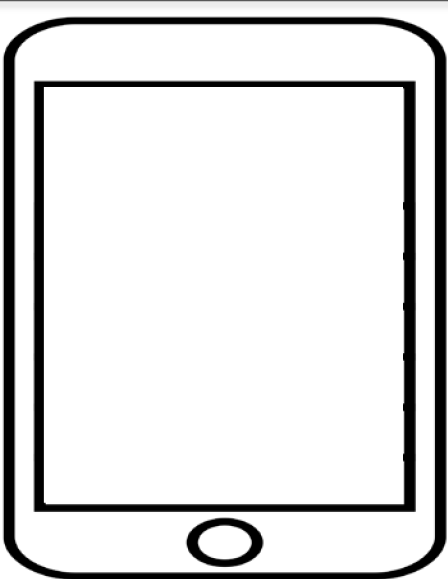

top

Place sticky completely inside box

Text me your takeaways
What is an important take away from the lesson?

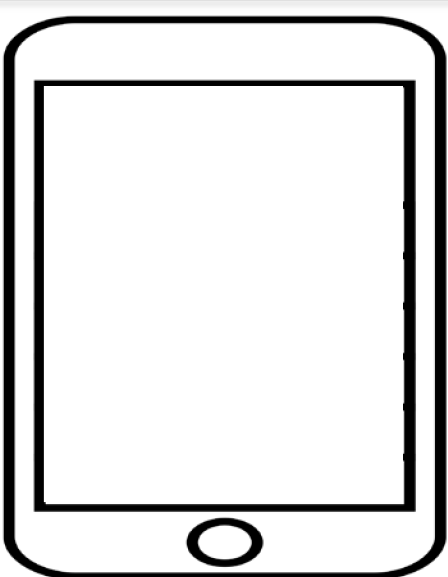

top

Place sticky completely inside box

Text me your takeaways
What is an important take away from the lesson?

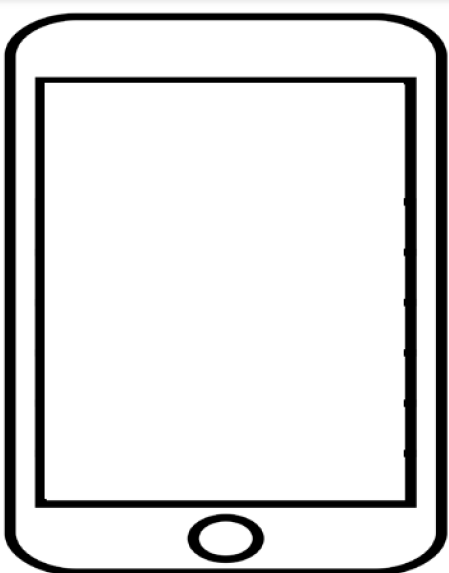

top

Place sticky completely inside box

Text me your takeaways
What is an important take away from the lesson?

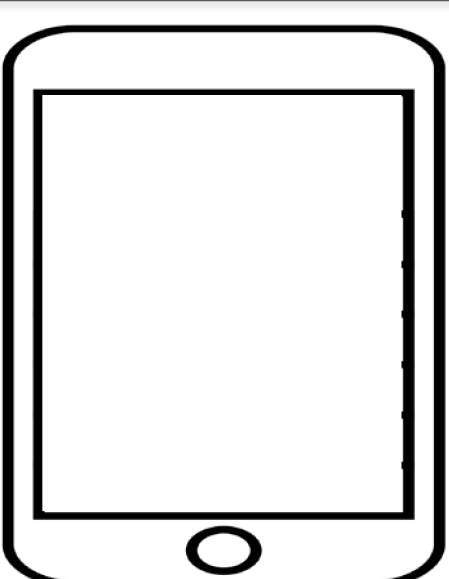

top

Place sticky completely inside box

Text me your takeaways
What is an important take away from the lesson?

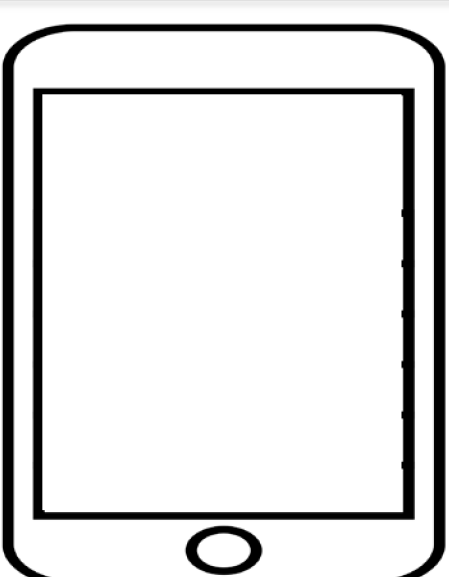

Exit Ticket Sticky Note Templates - Brain Dump

top

BRAIN-DUMP

Write down everything you learned from the lesson.

Place sticky completely inside box



top

BRAIN-DUMP

Write down everything you learned from the lesson.

Place sticky completely inside box



top

BRAIN-DUMP

Write down everything you learned from the lesson.

Place sticky completely inside box



top

BRAIN-DUMP

Write down everything you learned from the lesson.

Place sticky completely inside box



top

BRAIN-DUMP

Write down everything you learned from the lesson.

Place sticky completely inside box



top

BRAIN-DUMP

Write down everything you learned from the lesson.

Place sticky completely inside box



Exit Ticket Sticky Note Templates - Used to Think, Now I Think

top

I used to think...

Place sticky completely inside box

but now I think...

top

I used to think...

Place sticky completely inside box

but now I think...

top

I used to think...

Place sticky completely inside box

but now I think...

top

I used to think...

Place sticky completely inside box

but now I think...

top

I used to think...

Place sticky completely inside box

but now I think...

top

I used to think...

Place sticky completely inside box

but now I think...

Exit Ticket Sticky Note Templates - Sentence, Phrase, Word

top

Sentence

Write a sentence to summarize the lesson.

Phrase

What's the most important phrase in that sentence?

Word

What's the most important word in that phrase?

Place sticky completely inside box

top

Sentence

Write a sentence to summarize the lesson.

Phrase

What's the most important phrase in that sentence?

Word

What's the most important word in that phrase?

Place sticky completely inside box

top

Sentence

Write a sentence to summarize the lesson.

Phrase

What's the most important phrase in that sentence?

Word

What's the most important word in that phrase?

Place sticky completely inside box

top

Sentence

Write a sentence to summarize the lesson.

Phrase

What's the most important phrase in that sentence?

Word

What's the most important word in that phrase?

Place sticky completely inside box

top

Sentence

Write a sentence to summarize the lesson.

Phrase

What's the most important phrase in that sentence?

Word

What's the most important word in that phrase?

Place sticky completely inside box

top

Sentence

Write a sentence to summarize the lesson.

Phrase

What's the most important phrase in that sentence?

Word

What's the most important word in that phrase?

Place sticky completely inside box

Exit Ticket Sticky Note Templates - MVP

top

and the MVP goes to...

What was the most valuable part of the lesson?

Place sticky completely inside box

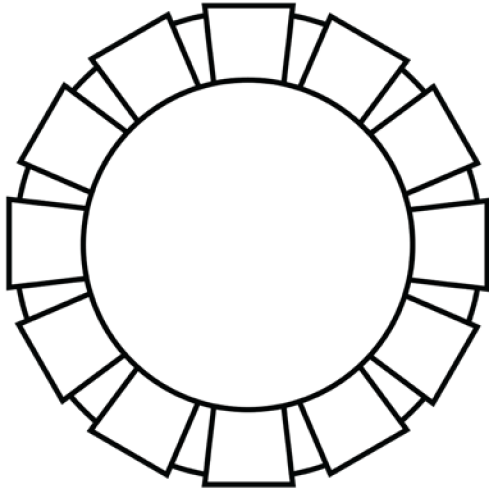

top

and the MVP goes to...

What was the most valuable part of the lesson?

Place sticky completely inside box

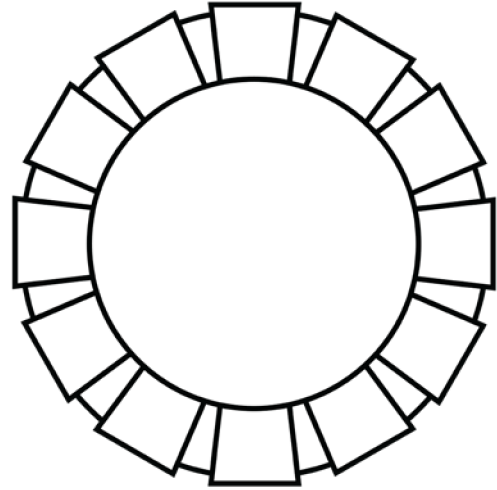

top

and the MVP goes to...

What was the most valuable part of the lesson?

Place sticky completely inside box

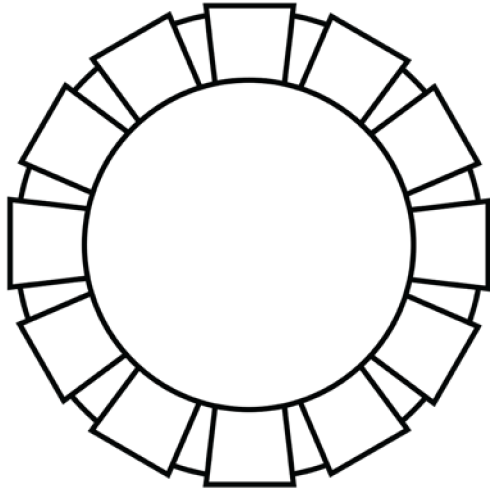

top

and the MVP goes to...

What was the most valuable part of the lesson?

Place sticky completely inside box

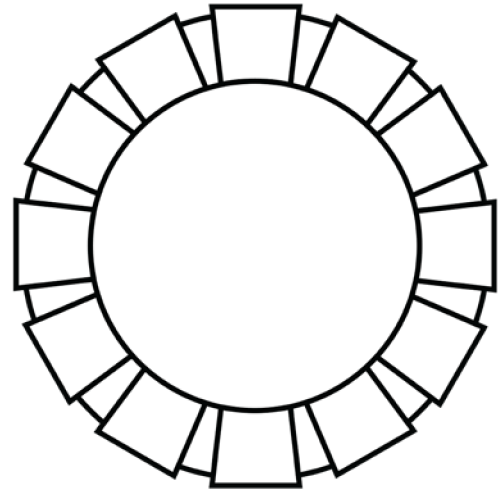

top

and the MVP goes to...

What was the most valuable part of the lesson?

Place sticky completely inside box

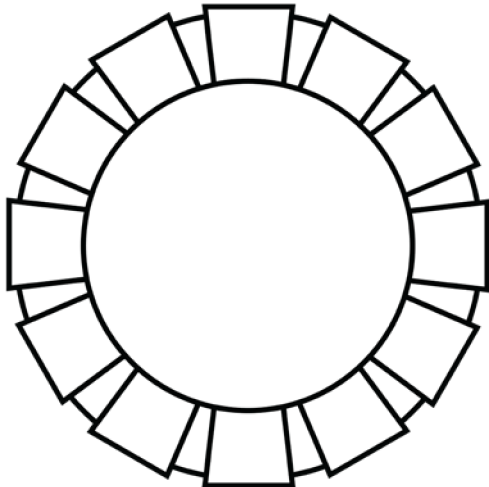

top

and the MVP goes to...

What was the most valuable part of the lesson?

Place sticky completely inside box

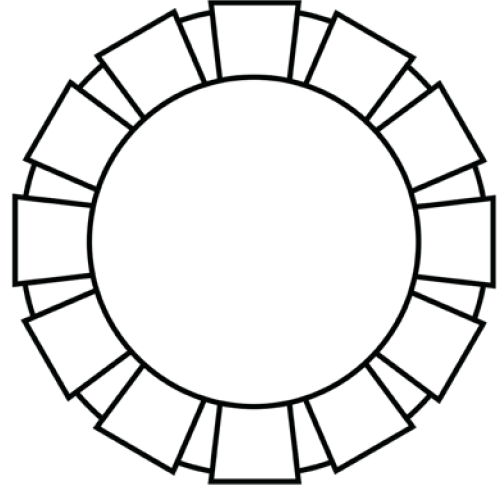

Exit Ticket Sticky Note Templates - Worth Noting

top

It's worth noting...

Place sticky completely inside box

What are some important ideas from the lesson that are worth taking note of?

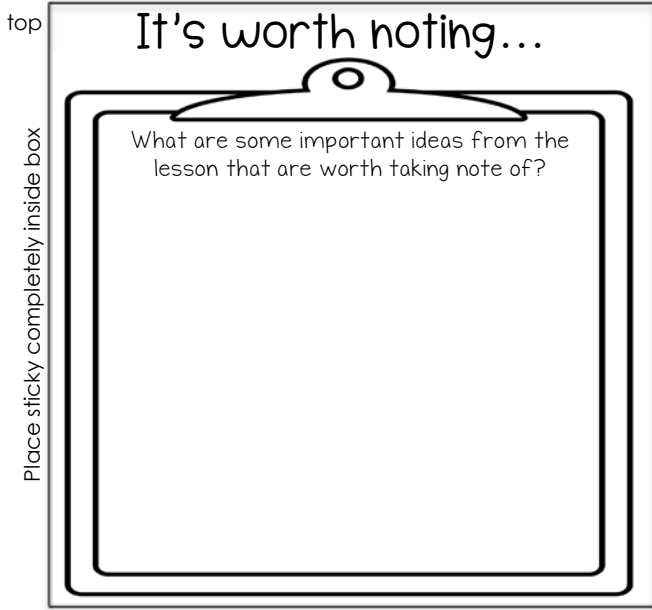
A rectangular sticky note template with a double-line border. At the top, it says "It's worth noting..." in a simple font. Below this is a smaller rectangle representing the sticky note itself, with a top edge that has a rounded shape and a small circle, mimicking a clip. Inside this smaller rectangle, the text "What are some important ideas from the lesson that are worth taking note of?" is written. To the left of the main rectangle, the text "Place sticky completely inside box" is written vertically. The word "top" is written at the top left corner.

top

It's worth noting...

Place sticky completely inside box

What are some important ideas from the lesson that are worth taking note of?

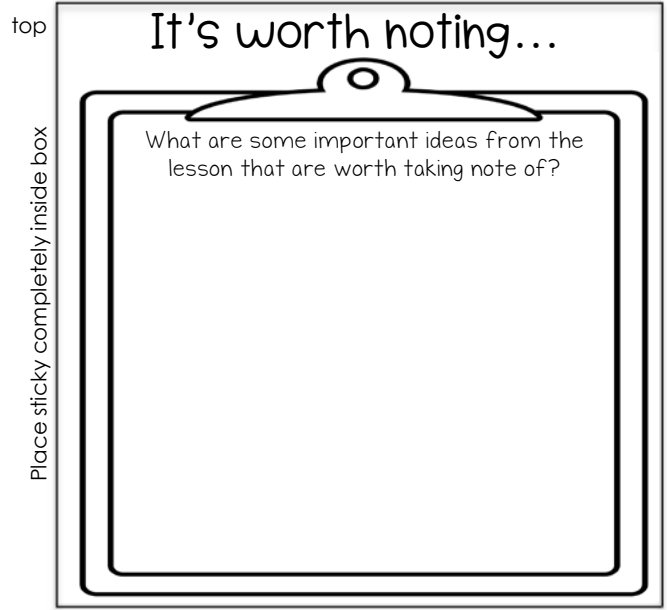
A rectangular sticky note template with a double-line border. At the top, it says "It's worth noting..." in a simple font. Below this is a smaller rectangle representing the sticky note itself, with a top edge that has a rounded shape and a small circle, mimicking a clip. Inside this smaller rectangle, the text "What are some important ideas from the lesson that are worth taking note of?" is written. To the left of the main rectangle, the text "Place sticky completely inside box" is written vertically. The word "top" is written at the top left corner.

top

It's worth noting...

Place sticky completely inside box

What are some important ideas from the lesson that are worth taking note of?

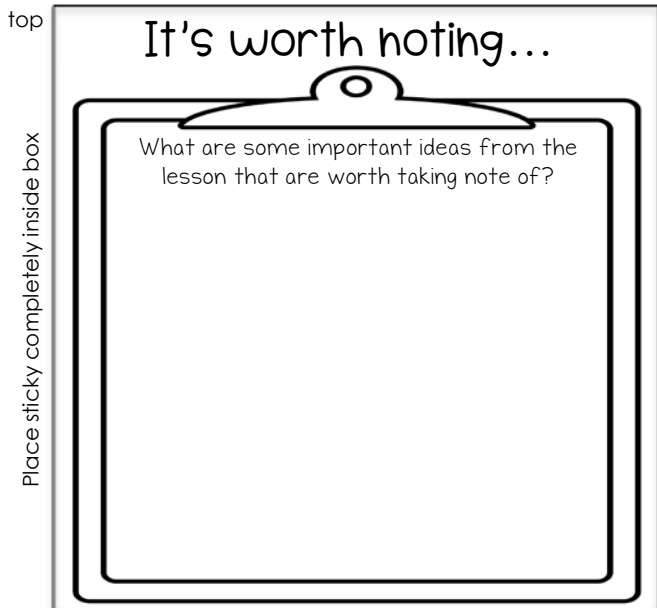
A rectangular sticky note template with a double-line border. At the top, it says "It's worth noting..." in a simple font. Below this is a smaller rectangle representing the sticky note itself, with a top edge that has a rounded shape and a small circle, mimicking a clip. Inside this smaller rectangle, the text "What are some important ideas from the lesson that are worth taking note of?" is written. To the left of the main rectangle, the text "Place sticky completely inside box" is written vertically. The word "top" is written at the top left corner.

top

It's worth noting...

Place sticky completely inside box

What are some important ideas from the lesson that are worth taking note of?

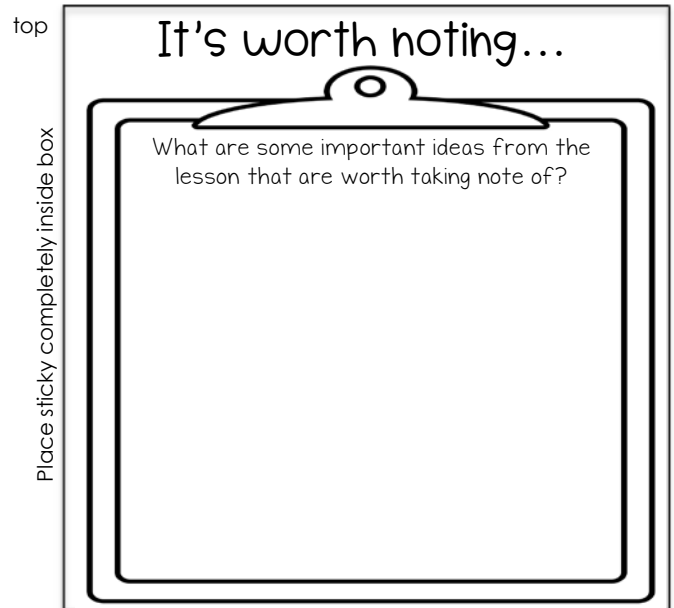
A rectangular sticky note template with a double-line border. At the top, it says "It's worth noting..." in a simple font. Below this is a smaller rectangle representing the sticky note itself, with a top edge that has a rounded shape and a small circle, mimicking a clip. Inside this smaller rectangle, the text "What are some important ideas from the lesson that are worth taking note of?" is written. To the left of the main rectangle, the text "Place sticky completely inside box" is written vertically. The word "top" is written at the top left corner.

top

It's worth noting...

Place sticky completely inside box

What are some important ideas from the lesson that are worth taking note of?

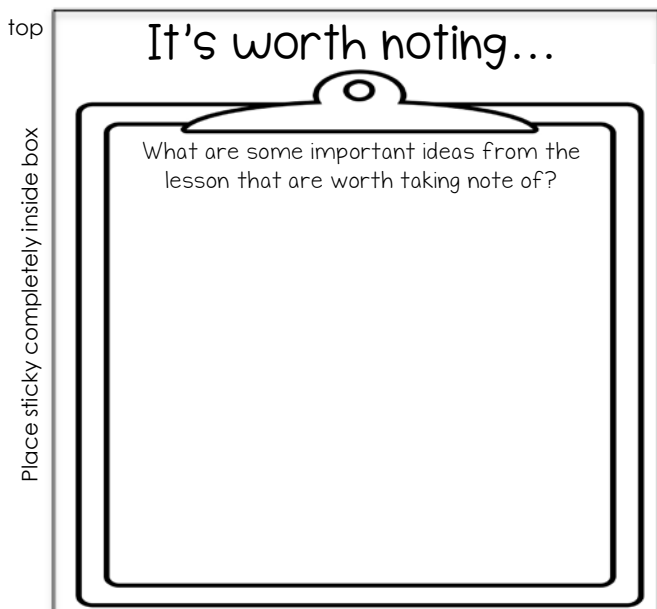
A rectangular sticky note template with a double-line border. At the top, it says "It's worth noting..." in a simple font. Below this is a smaller rectangle representing the sticky note itself, with a top edge that has a rounded shape and a small circle, mimicking a clip. Inside this smaller rectangle, the text "What are some important ideas from the lesson that are worth taking note of?" is written. To the left of the main rectangle, the text "Place sticky completely inside box" is written vertically. The word "top" is written at the top left corner.

top

It's worth noting...

Place sticky completely inside box

What are some important ideas from the lesson that are worth taking note of?

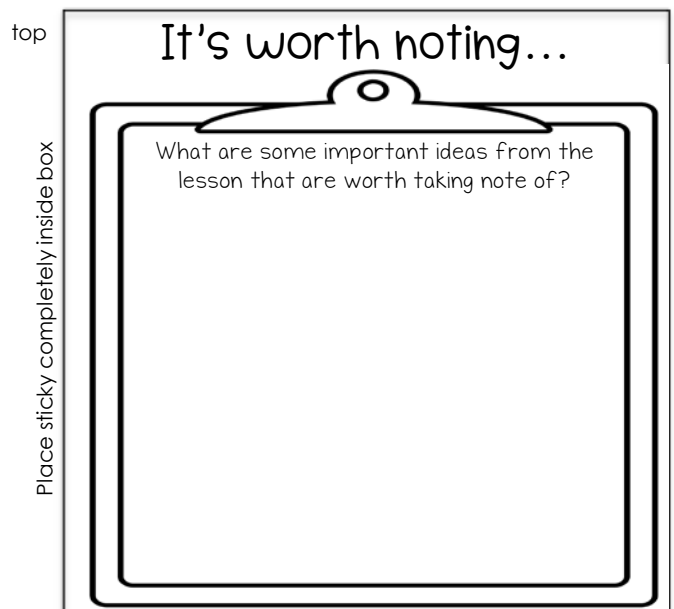
A rectangular sticky note template with a double-line border. At the top, it says "It's worth noting..." in a simple font. Below this is a smaller rectangle representing the sticky note itself, with a top edge that has a rounded shape and a small circle, mimicking a clip. Inside this smaller rectangle, the text "What are some important ideas from the lesson that are worth taking note of?" is written. To the left of the main rectangle, the text "Place sticky completely inside box" is written vertically. The word "top" is written at the top left corner.

Exit Ticket Sticky Note Templates - Making Connections

top

Making Connections

What background knowledge can you connect the ideas in this lesson to?

Place sticky completely inside box



top

Making Connections

What background knowledge can you connect the ideas in this lesson to?

Place sticky completely inside box

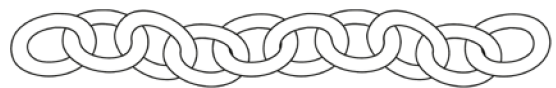

top

Making Connections

What background knowledge can you connect the ideas in this lesson to?

Place sticky completely inside box



top

Making Connections

What background knowledge can you connect the ideas in this lesson to?

Place sticky completely inside box



top

Making Connections

What background knowledge can you connect the ideas in this lesson to?

Place sticky completely inside box



top

Making Connections

What background knowledge can you connect the ideas in this lesson to?

Place sticky completely inside box



Exit Ticket Sticky Note Templates - Wise Words

top

Wise Words

What wise words would you share with someone who is studying the same skill, strategy, or topic?

Place sticky completely inside box



top

Wise Words

What wise words would you share with someone who is studying the same skill, strategy, or topic?

Place sticky completely inside box



top

Wise Words

What wise words would you share with someone who is studying the same skill, strategy, or topic?

Place sticky completely inside box

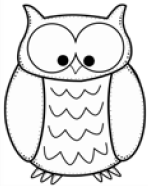

top

Wise Words

What wise words would you share with someone who is studying the same skill, strategy, or topic?

Place sticky completely inside box



top

Wise Words

What wise words would you share with someone who is studying the same skill, strategy, or topic?

Place sticky completely inside box

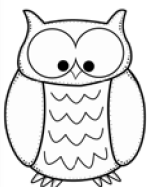

top

Wise Words

What wise words would you share with someone who is studying the same skill, strategy, or topic?

Place sticky completely inside box



Exit Ticket Sticky Note Templates - Key Words

top

Key Words

List out the important key words you need to know to understand this topic/idea.

Place sticky completely inside box

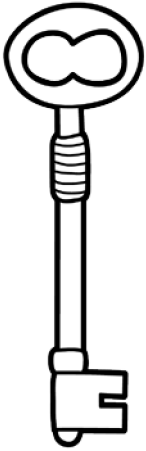

top

Key Words

List out the important key words you need to know to understand this topic/idea.

Place sticky completely inside box

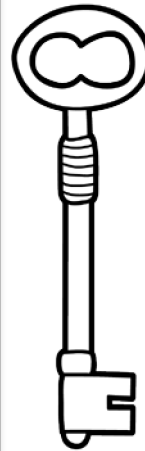

top

Key Words

List out the important key words you need to know to understand this topic/idea.

Place sticky completely inside box

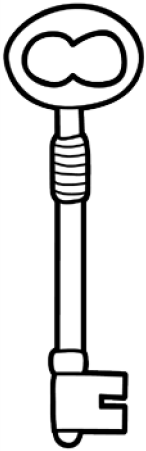

top

Key Words

List out the important key words you need to know to understand this topic/idea.

Place sticky completely inside box

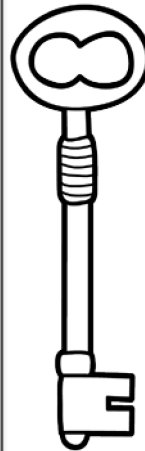

top

Key Words

List out the important key words you need to know to understand this topic/idea.

Place sticky completely inside box

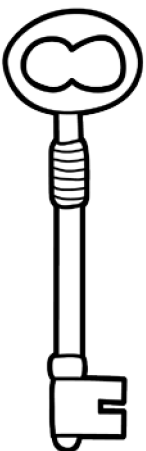

top

Key Words

List out the important key words you need to know to understand this topic/idea.

Place sticky completely inside box

