



IMPUMP[®]
Pod hrasti 28, 1218 Komenda, Slovenia

SERVICE MANUAL

HORIZONTAL CENTRIFUGAL PUMP

Model: BW/BWJ(T)



Warning

- Ground motor before connecting to power supply.
- Do not touch the pump while it is running.
- Do not run the pump without water.

10. Addendum

Calculation of min. inlet pressure

$$H = P_b \times 10.2 - NSPH - H_f - H_v - H_s$$

P_b Atmosphere pressure, unit-bar

H_v Boiling pressure, Check table 1

NSPH Net inlet pressure, Check table 2

H_f Friction loss in the pipeline

H_s Sureness surplus value, generally 0.5m

If H is positive value, the suction head is H, or H should be filled

The noise from motor or pump	
Motor power (kW)	DB(A)
0.37	56
0.55	57
0.75	56
1.1	57
1.5	65
2.2	65
3.0	65
4.0	66
5.5	73
7.5	73
11	80
15	77

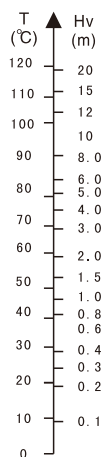
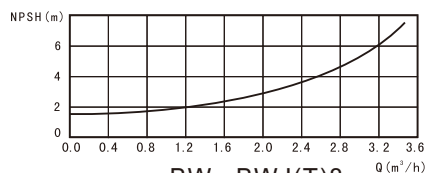
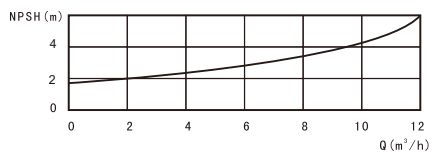

Table 1

BW, BWJ(T)2



BW, BWJ(T)8



BW, BWJ(T)4

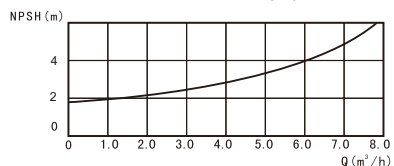

BW, BWJ(T)16

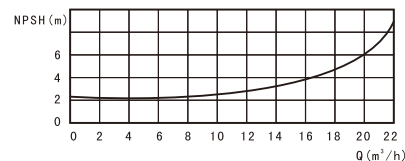

Max. inlet pressure

Model	P
BW, BWJ(T)2-2	0.6MPa
BW, BWJ(T)2-3~BW, BWJ(T)2-6	1.0MPa
BW, BWJ(T)4-2	0.6MPa
BW, BWJ(T)4-3~BW, BWJ(T)4-6	1.0MPa
BW, BWJ(T)8-2~BW, BWJ(T)8-5	0.6MPa
BW, BWJ(T)16-2~BW, BWJ(T)16-3	0.6MPa

Technical data is subject to change without notice.

Contents

1. Working condition.....	1
2. Pumping liquids.....	1
3. Motor selection.....	2
4. Instruction of model and structure.....	2
5. Installation table and sketch map.....	3
6. Instruction of installation.....	4
7. Operation indication.....	5
8. Maintenance.....	5
9. Failure analysis and disposal.....	6
10. Addendum.....	7

Thanks for you buying our pumps, please read the manual carefully before using and keep it well

⚠ Notice:

- Ground motor before connecting to power supply
- Do not touch the pump and motor while running;
- Do not run it without water

The people who use or install the pump must know about the related electric knowledge and operate in a safe way.

Cut off the power before moving or disassembling to avoid accident.

The pump can not be used in the inflammable place or used for pumping flammable liquids.

Discharge the water in the pump body while leaving unused to avoid frost.

1. Working condition

Medium temperature: 0°C ~ 120°C

Max. ambient temperature: +40°C

Max. ambient pressure: 1.0MPa

While the density of the pumping liquid is heavier than water, it is better to use motor of higher power in case that the density or viscosity of medium is above that water.

numbers of stop/start for motor 4KW or less than: maximum 100 times per hour.

2. Pumping liquids

Thin, clean, non-flammable, non-explosive medium containing no granule or fibre.

Such as mineral water, softened water, pure water, light-density medium.

It can be used for pumping slight corrosive medium because of the stainless steel material.

9. Failure reason analysis and disposal

Failure	reason	way of disposal
Do not startup	1. Lack of phase 2. Impeller blocked 3. wire, connection or cable broken 4. Stator wiring is broken 5. Circuit controlling panel broken	1. Check the wire and repair 2. Get rid off the sundries 3. Repair by omnipotence gauge or replace it 4. Replace it 5. Repair or replace it
No water out	1. Wrong rotation direction 2. Valve closed or broken 3. Pipe or impeller blocken 4. Air in the pump chamber 5. High liquid temperature 6. Higher suction head 7. Higher head	1. Change the connection of motor 2. Check, repair or replace it 3. Clear up or lower the head 4. Re-fill liquid to deflate air 5. Lower the temperature 6. Lower the position of pump 7. Lower head or change pump
Inadequate quantity flow	1. Lower rotation speed 2. Higher head 3. Liquid with high density 4. Liquid with high viscosity 5. Anti-grinding ring is broken 6. Great resistance in the pipeline 7. Wrong selection of pump	1. Check the circuit 2. Lower head 3. Deluting it 4. Lower the viscosity 5. Change it 6. Reduce the bending pipeline 7. Select model again
Vibration or noise	1. Shaft is bended 2. Bearing broken	1. Revise or change it 2. Change it
Inadequate head	1. Air in the liquid 2. Lower rotation	1. Lower temperature or enlarge pressure 2. Increase it
Big current	1. Lower voltage 2. Pipeline or impeller blocked 3. High viscosity 4. Bigger quantity flow 5. Worn bearing	1. Adjust the voltage 2. Clear up it 3. Lower the viscosity 4. Change small 5. Change bearing

The electrical connection should be operated by qualified electrician according to the regulation. Please connect as the indication of wiring diagram in the junction box. Protection equipment is recommended to avoid the damage from unsteady voltage or overload.

Ensure the well grounded according to the rule. While running it, the mark "DANGEROUS! HUMAN AND BEAST ARE NOT ALLOWED IN" should be applied to avoid accident

The safe-guard controlling cupboard should be used. Do not connect the electrical wires directly.

The pressure gauge should be applied to inspect control the operation of pump.

If there are some granule or fibre in it, the filter should be equipped on the inlet side to avoid the block on the impeller, even burn the motor.

7. Operation indication

The insulation resistance between motor stator winding and motor shell and that between stator windings should not be less than 1.0 MΩ under thermal condition or after temperature rise test, and should not be less than 20 MΩ in normal state. If it is, corresponding measures should be taken to adjust the insulation resistance and reach to the rated value, after which you can operate the pump set.

Check whether the bottom screw is soft, whether the connection of inlet and outlet reliable. Then close the valve on the outlet, open the separating valve on the inlet side and air-deflation screw slowly until a steady stream out from the air-deflation hole. Then tighten the air-deflation screw. Do not run it without medium or with air in it.

Try to start-up the motor (no more than 1 minute) to see whether the rotating direction is the same as the indication on the pump body. If not, change the connection of any two wires and re-fix it.

Start-up the motor, soften the air-deflation screw to discharge the air and then tighten it. The quantity flow is set around the rated quantity flow (0.5 times to 1.3 times). The pump can not work in condition of lower than 60% rated head to ensure it can not be burnt.

Close the outlet valve and gauges slowly, then cut off the power supply and discharge the liquid remains.

Notice: Do not start-up the pump frequently. No more than 50 times per hour.

Pay attention to its noise, if unusual, stop and solve the problem.

Periodically check the working condition, operating pressure, leakage, temperature and etc.

8. Maintenance

Make sure the power has been cut off, the pump can not start-up suddenly, the pipelines are all closed.

Every time after pumping liquids with heavier viscosity, the pump must be cleaned by pumping clear water for a few minutes.

Some one should be assigned to manage the pump and check the insulation resistance.

Clean and lubricate the pump periodically.

3. Motor Selection

Full-enclosed ventilating two-pole standard motor

Protection class: IP 55

Insulation class: F

Standard voltage (50Hz): single phase 220V

Three-phase 220V/380V

4. Instruction of model and structure

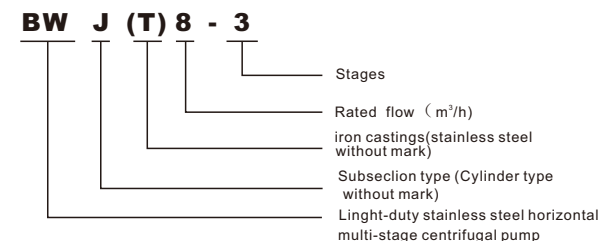

NO.	Name	Material
1	Pressure-resistant cylinder subassembly	stainless steel
2	Connection pipe	stainless steel
3	Sleeve	stainless steel
4	Clamp plate	stainless steel
5	Bearing	hard alloy
6	Inlet fluid director	stainless steel
7	Impeller	stainless steel
8	Bearing fluid director	stainless steel
9	Fluid director	stainless steel
10	Round cover	stainless steel
11	Outlet fluid director	stainless steel
12	Anchor ear subassembly	stainless steel
13	Front-cover subassembly	stainless steel
14	Mechanical seal	hard alloy, fluorin rubber
15	Bracket	cast iron
16	Electric motor	horizontal machine

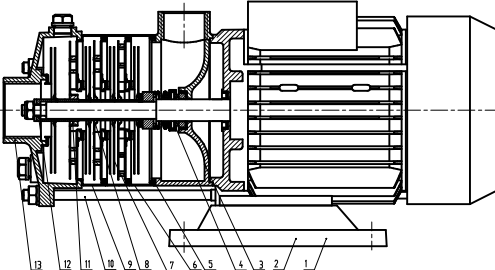

1	Electric motor	horizontal machine
2	Bracket	Cast iron
3	Out-tet chamber	stainless steel/cast iron
4	Mechanical seal	hard alloy, fluorin rubber
5	Mechanical gasket	waterproof paper
6	Fluid director	stainless steel
7	Impeller	stainless steel
8	Round cover	stainless steel
9	Bearing fluid director	stainless steel
10	Pull-rod	chromium 45
11	Bearing	hard alloy
12	Sleeve	stainless steel
13	In-tet chamber	stainless steel/cast iron

BWJ (T)

5. Installation table and sketch map

Model	L	L ₁	E	N	D	D ₁	H	K	G ₁	G ₂
BW2-2	395	161	210	111	137	165	219	75	1	1
BW2-3	395	161	210	111	137	165	219	75	1	1
BW2-4	395	161	210	111	137	165	219	75	1	1
BW2-5	395	161	210	111	137	165	219	75	1	1
BW2-6	430	161	210	111	156	165	229	75	1	1
BW4-2	395	161	210	111	137	165	219	75	1 1/4	1
BW4-3	395	161	210	111	137	165	219	75	1 1/4	1
BW4-4	430	161	210	111	156	165	229	75	1 1/4	1
BW8-2	565	281	265	118	156	230	236	75	2	2
BW8-3	565	281	265	118	156	230	236	75	2	2
BW8-4	575	281	265	118	169	230	246	98.5	2	2
BW8-5	575	281	265	118	169	230	246	98.5	2	2
BW16-2	575	281	265	118	169	230	246	98.5	2	2
BW16-3	575	281	265	118	169	230	246	98.5	2	2

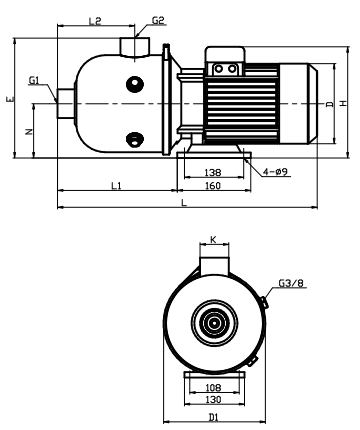

Model	L ₁	L ₂	L ₃	Y	D	H	K	G ₁	G ₂
BWJ(T)2-2	313	88	87	100	137	208	75	1	1
BWJ(T)2-3	331	106	105	100	137	208	75	1	1
BWJ(T)2-4	349	124	123	100	137	208	75	1	1
BWJ(T)2-5	367	142	141	100	137	208	75	1	1
BWJ(T)2-6	445	160	159	111	156	229	75	1	1
BWJ(T)4-2	331	106	105	100	137	208	75	1 1/4	1
BWJ(T)4-3	358	133	132	100	137	208	75	1 1/4	1
BWJ(T)4-4	445	160	159	111	156	229	75	1 1/4	1
BWJ(T)4-5	472	187	186	111	156	229	75	1 1/4	1
BWJ(T)4-6	499	214	213	111	156	229	75	1 1/4	1
BWJ(T)8-2	435	123	107	114	156	232	75	1 1/2	1 1/4
BWJ(T)8-3	465	153	137	114	156	232	75	1 1/2	1 1/4
BWJ(T)8-4	505	183	167	118	169	246	98.5	1 1/2	1 1/4
BWJ(T)8-5	535	213	197	118	169	246	98.5	1 1/2	1 1/4
BWJ(T)16-2	460	138	122	118	169	246	98.5	1 1/2	1 1/4
BWJ(T)16-3	505	183	167	118	169	246	98.5	1 1/2	1 1/4

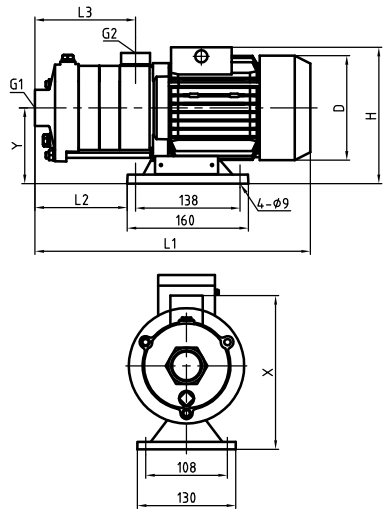

6. Instruction of installation

The pump should be installed in the ventilated place to ensure the cool air can get in to cooling fan in the motor. It is better to equip a anti-vibration part to make the noise lower. Separating valves should be used in the inlet and outlet sides to avoid water-draining in the system while cleaning ,repairing or replacing the pump

Choose short suction pipe and ensure unblocked. The pipeline should be installed as following pictures to avoid the hurt on pump for the elongate caused by temperature variation. Do not put the pipeline on the pump to avoid distortion.

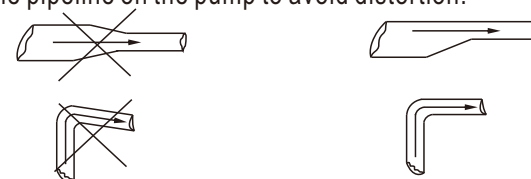

Make sure the height between liquid surface and inlet side is within the suction head while installing.