



**IMP PUMPS**<sup>®</sup>  
Intelligent Motor Pumps

# SERVICE MANUAL

## Vortex Type Micro Clean Water Pump

Model: HT



Warning

- Before operation, make sure that electric pump is grounded reliably and leakage protection device is equipped.
- Don't touch electric pump while it is running.
- Don't run electric pump without water.

# Contents

I. Safety and Installation Precautions .....	1
II. Product Overview .....	3
III. Working Conditions .....	3
IV. Technical Parameters .....	3
V. Wiring Schematic Diagram of the Electric Pump .....	3
VI. Installation Schematic Diagram .....	4
VII. Installation of the Electric Pump and the Precautions .....	6
VIII. Maintenance .....	9
IX. Common Fault Phenomena and Solutions .....	10

 Thank you very much for choosing our products, and please read over the Operating Manual and keep it properly before the installation and use. The improper usage may lead to personal injuries and property damages.



- Before operation, make sure that electric pump is grounded reliably and leakage protection device is equipped;
- Don't touch electric pump while it is running;
- Don't run electric pump without water.

### **Warnings for Children**

- Any child or any adult who has any physical, sensory or mental defects or lacks of the relevant experience or knowledge, if supervised or given the method unsafe use of this product as well as knowing the dangers involved, may use this product.
- No child shall play with this product as a toy.
- Without supervision, no child shall be allowed to clean or maintain this product.

### **Pressure Warning**

- The system where a pump lies shall be able to withstand the maximum pressure of the pump.

### **Electricity Warning**

- The electric power system may be used only when it has the safety protection measures specified by the existing provisions of the country where the product is installed.

### **Modification-related Warning**

- Where any electric pump is tampered, modified and/or operates outside the recommended operating scope or goes against any other instruction given in this manual, the manufacturer will not guarantee the correct operation of the electric pump or be responsible for any loss which might be caused by the electric pump.
- The manufacturer refuses to undertake any responsibility for any error which might appear in this manual due to misprint or misreplication. The manufacturer reserves the right to make any modification to the product, which, in its opinion, is necessary or useful, without affecting basic features of the product.

The users must strictly observe the “Notice”, “Warning” and other terms and signs contained in the Manual.

- ⚠ Danger: Failing of observing relevant rules may cause electric shock;
- ⚠ Warning: Failing of observing relevant rules may cause serious injury of the body;
- ⚠ Notice: Failing of observing relevant rules may cause product damage;
- 🚫 Expresses No Touching;
- ⚠ Expresses Must Obey;
- 🚫 Expresses Forbidding Act;
- ⚡ Expresses the Grounding Mark for electric shock prevention.

**Statement:** IMP PUMPS shall not be liable for follow loss or damage suffered as a result of failure to comply with the content of the manual:

- Pump failure resulting from disassembly or maintenance conducted by non-professional people without certificate, or using the pump beyond its operating conditions;
- Losses caused by voltage, machinery or chemistry;
- Environmental pollution caused by pumping dangerous medium.

## I. Safety and Installation Precautions

The electric pump should be correctly equipped with an electricity leakage protective device and you should ground the pump reliably (connect the grounding wire to the marked terminal) at the grounding mark of the electric pump or cable as well as the power socket is connected to ground. As shown in the figure below, it is strictly forbidden to connect the ground wire to the gas pipe or it may cause explosion; do not wet the power plug and the power socket connected shall be located at areas where it is not affected by dampness.

⚠ The electrical connection must be conducted by personnel with electrician certificate according to the local specifications and the safety standards.

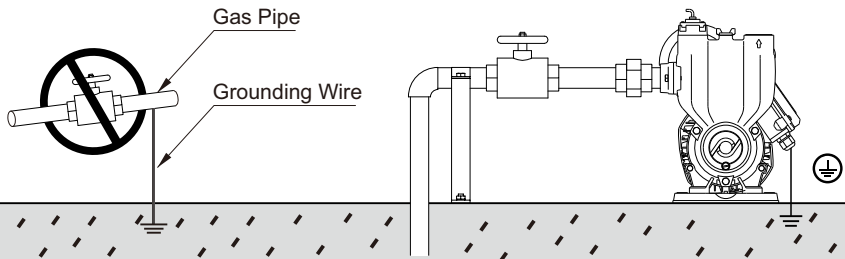

1. When the electric pump is working, if you want to adjust the pump location or there is any other action to touch the pump, you must cut off the power first. It is strictly forbidden to wash, swim and herd, etc. near the pump working face in order to avoid occurrence of accidents.
2. When transporting or installing the electric pump, it is strictly forbidden to lift the electric pump by grasping the cable for fear of the damage of the cable and causing leakage or electric shock.
3. On account of any safety principle, maintenance in any form shall be conducted after cutting off the power of the water pump.

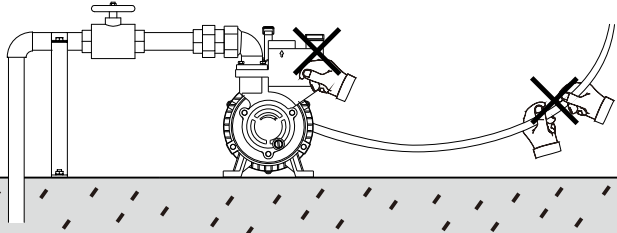

The electric pump is only used to deliver clean water or similar liquid and it is strictly forbidden to use it to deliver any flammable, gasifiable and explosive liquid, such as gasoline and alcohol, etc. which is an extremely dangerous behavior.

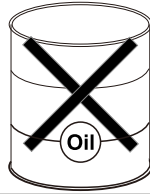

The electric pump shall be installed at a cool and dry place. External motor protection should be used to eliminate environmental concerns, or it will easily cause the acceleration of the ageing of the water pump and the leakage danger. Motor is not waterproof and should never be submersed into any liquid. Do not allow water to spray directly onto motor to avoid the dampness of the motor which may damage the winding insulation and thus cause the leakage accident.

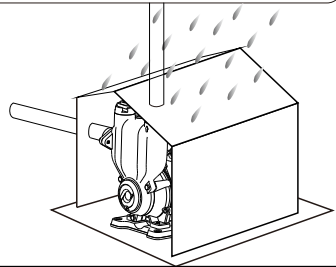

When taking anti-freezing measures for the water pump in winter, do not cover combustibles on the motor or pump for anti-freezing in case of causing fire accident and be sure not to cover the thermal insulation material on the motor or it will cause poor ventilation and heat dissipation to easily lead to fire.

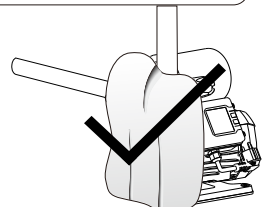
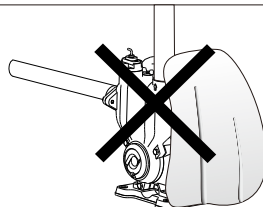

## II. Product Overview

Vortex-type Micro Clean Water Pumps (hereinafter referred to as the “electric pumps”) include HT model; the electric pump is composed of electric motor, pump and seals. The electric motor is asynchronous motor. The impeller structure of vortex pump is of the vortex type, which can achieve a higher lift head. HT has no self-priming function.

## III. Working Conditions

The electric pump shall continuously work normally under the following conditions:

1. The environment ambient shall not exceed +40°C;
2. The medium temperature is 0~+40°C;
3. The PH value of the medium shall be between 6.5 - 8.5;
4. The volume ratio of the solid impurity in the medium shall not exceed 0.1% and the particle size shall not exceed 0.2mm;
5. The voltage and frequency of the power supply must meet the rated voltage and frequency on the nameplate of the electric pump; the fluctuation range of the voltage is  $\pm 10\%$  of the rated value.

## IV. Technical Parameters

**Table 1**

Model	Power		Max Flow (L/min)	Max Head (m)	Head Range (m)	Max Suction (m)
	kW	HP				
HT 25/0.37	0.37	0.5	40	40	0~30	8

Table 2(Single-Phase Current Reference Table)

Power (kW)	I(A)						
	110V	115V	120V	127V	220V	230V	240V
0.37	5.5	5.2	5.0	4.7	2.7	2.6	2.5

## V. Wiring Schematic Diagram of the Electric Pump

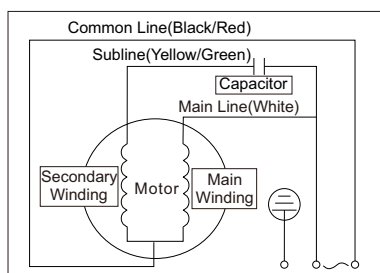

## VI. Installation Schematic Diagram

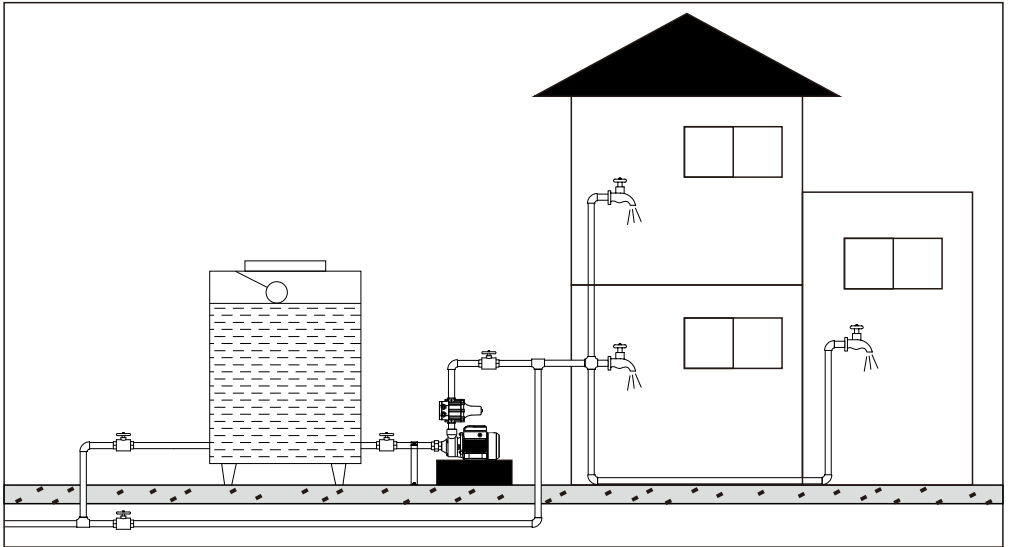

Tap Water Pressurization

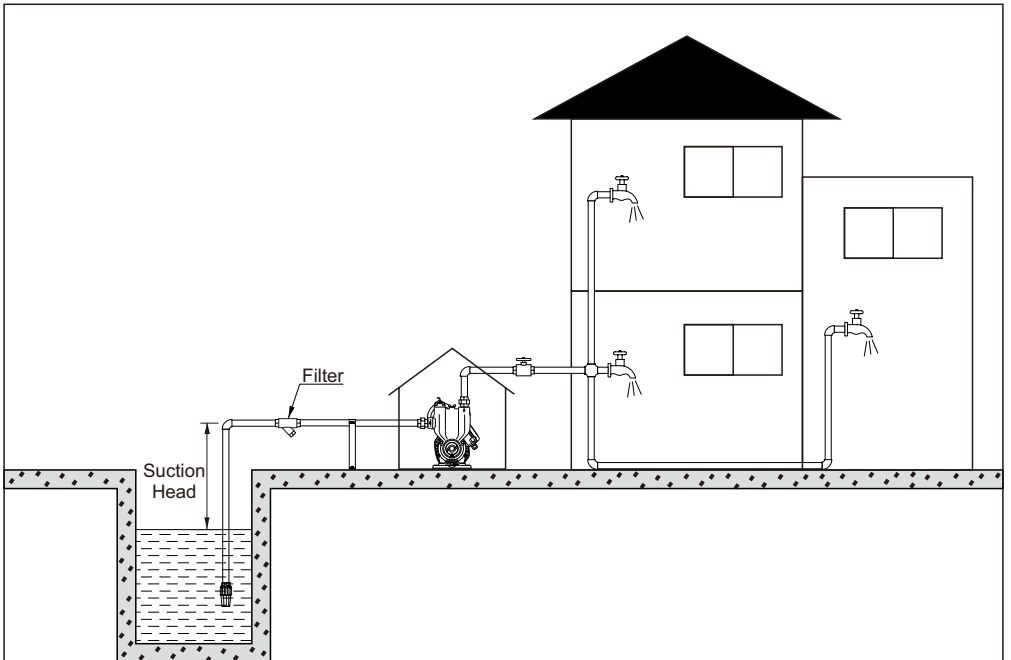

Lifting Water from Well

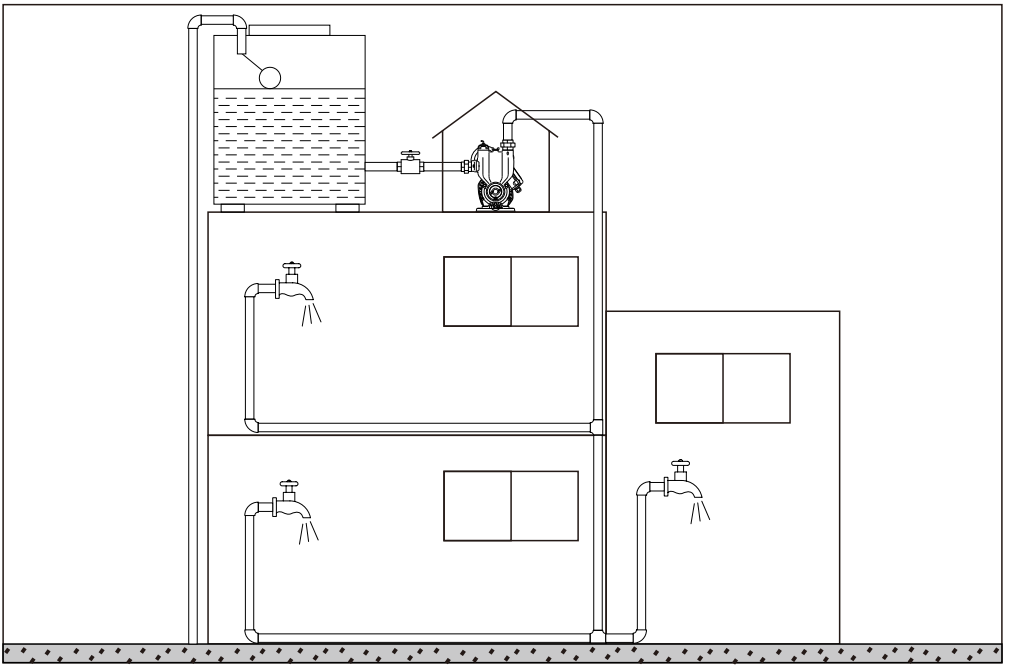

Roof Water Tower Indirect Pressure Water Supply



## VII. Installation of the Electric Pump and the Precautions

Before installation and use, you should check whether the electric pump is damaged during the transportation and storage, such as whether the cable, outgoing line and the plug (if equipped), etc. are intact and whether the insulation resistance is higher than 50MΩ.

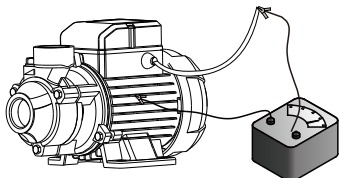

When installing, you should fix the pump well, and both the inlet and outlet pipelines should be supported by support frames and not only by the pump body.

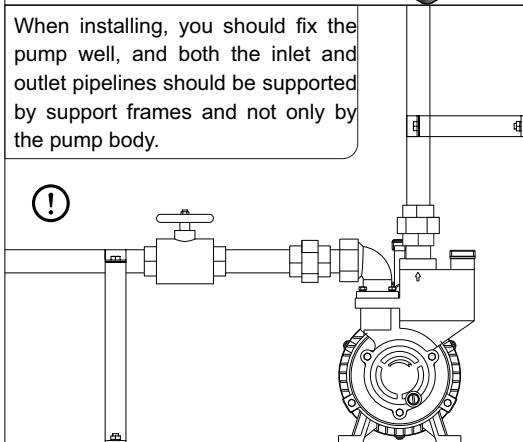

1. When using, you should pay attention to the water level and not expose the foot valve or lower end of the inlet pipe above the water surface.
2. When installing the water inlet, please pay attention that the height of the inlet pipe shall not exceed that of the inlet of the pump, or it will cause the suction difficulty of the pump.

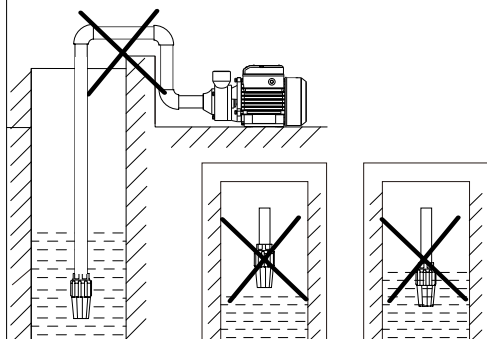

1. Use steel tube or rubber tube (not too soft for fear of being sucked flat) to connect the foot valve and the inlet of the electric pump, and the inlet pipeline and the junction part shall be ensured sealed without leakage.

2. The water outlet shall be connected firmly in case of water splashing on the motor part and cause electricity leakage of the electric pump. When using the rubber tube, please pay attention to its temperature tolerance limit and avoid breakage and water leakage of the rubber tube resulted from its heating and deformation.

3. After connecting the upper end of the inlet pipe and the inlet of the electric pump, you should ensure that the foot valve of the water inlet is immersed in the water. In order to ensure the reliable use of the electric pump, you should set the effective filter screen and the foot valve and the filter screen are requested to be over 30cm far from the bottom of pool in case that the mud and sand are absorbed into the pump cavity and affect the operation.

4. At the same time, it is required that the installation of the pipelines should be as short as possible and try to avoid multi connectors, and the suction height shall not exceed the suction requirement of the electric pump.



**NOTICE**

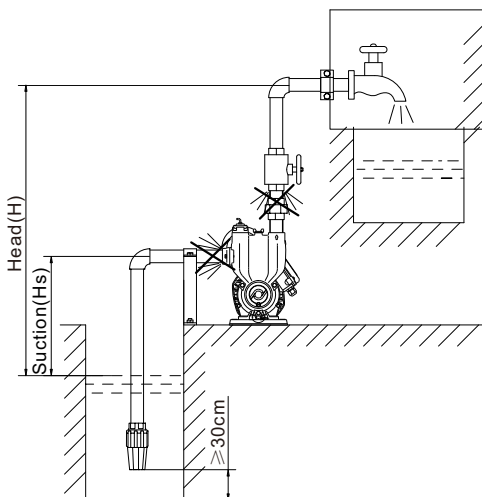

1. When first use it, please be sure to fill the pump body with water and then plug in the power to avoid dry operation without water.  
 2. Self-priming pumps can start with the pump body filled with water, do not have to keep all inlet pipes filled with water, and the inlet pipes of non self-priming pumps must be filled with water and exhaust all air in pipeline system.

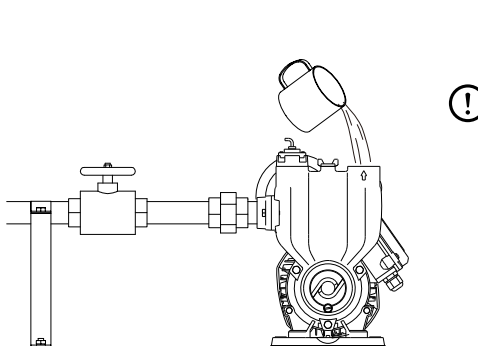

Before using the pump, please use the screwdriver to toggle the fan blades to check whether the electric pump rotates smoothly.



NOTICE

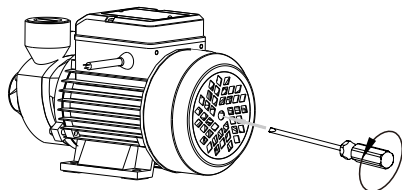

For areas with high sand content, it is advised to install a Y-shaped filter at the inlet pipe to prevent the sand from entering into the pump body and causing wearing or blocking of the impeller.

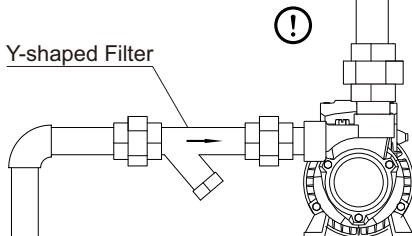

The electric pump shall be conducted test run before use, and the time shall not exceed 10s because long-time dry operation will damage the mechanical seal. For three-phase electric pump, you need to check whether the rotation direction is consistent with the rotation mark. In case of inverse rotation of the electric pump, you should cut off the power immediately and adjust any two phases of the three phases.



NOTICE

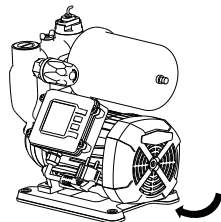

The electric pump should be installed at places where it is convenient for checking and maintenance and be kept dry and ventilated. When installing the electric pump at narrow places, you should install it according to the figure below and the fan housing must be at a distance of over 25cm from the wall to facilitate heat dissipation.

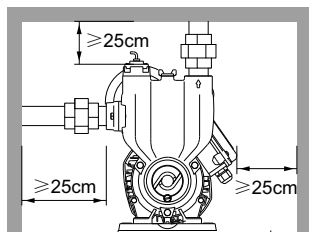

You should set drainage ditch around the electric pump to form natural drainage to avoid property damage due to water leakage when using, repairing and replacing the water pump (especially at the basement, kitchen, stairs and other places).



NOTICE

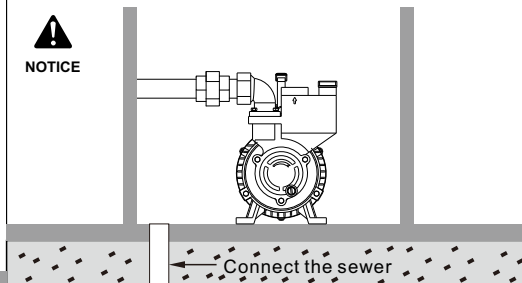

If the user wants to change the electric pump to auto control, he just needs to install an appropriate pressure control device on the outlet pipeline.

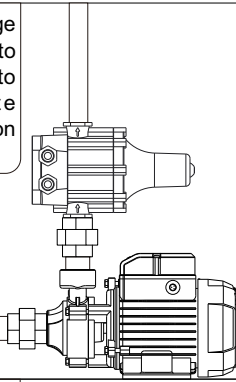

For three-phase electric pump that needs to be equipped with an overload protector, you should select the matching overload protector according to the current or power.

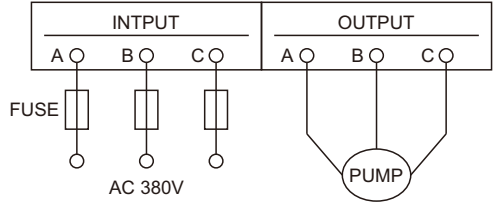

You should try to avoid using the vortex pump within the maximum head range in case that the electric pump is damaged due to overload. The full-open use of the faucet consumes little power and saves the electric energy.

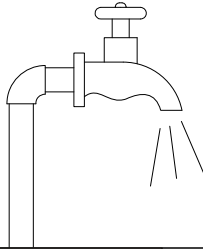

If you have to lengthen or replace the cable, please use the cable with the same specifications or specifications exceeding the original ones, and pay attention that the connection should be firm, waterproof and insulating.



When you need to adjust the pressure switch, you shall open the housing of pressure switch and use a slot type screwdriver or wrench to turn the pressure adjusting screw towards the “+” direction.

When non-professional personnel adjust the switch, they are prohibited to operate with the power on; when professional personnel operate with the power on, they must take the safety protection measures.

The electric pump shall not operate more than five minutes with the outlet valve closed because the long-time operation without flow change will cause the temperature and pressure rise of the liquid in the pump body which will further lead to leakage or damage of the water pump, pipeline and other parts.



**WARNING**

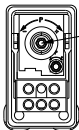

Square Pressure Switch Adjusting Screw



Round Pressure Switch Adjusting Screw

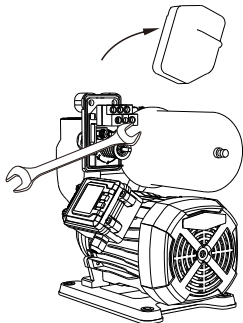

**NOTICE**

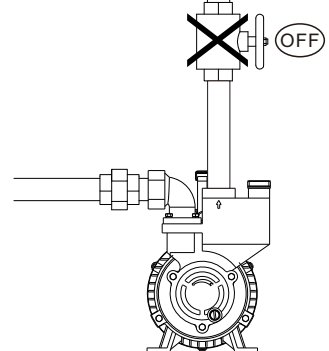
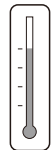

When the pump is used for pumping hot or hard water, or it is used in aging pipelines, you need to regularly clean the foreign matters on the check valve and filter screen to avoid the failure of the flow switch.

After installation and use, you shall remove and dispose the packing materials according to the local law.

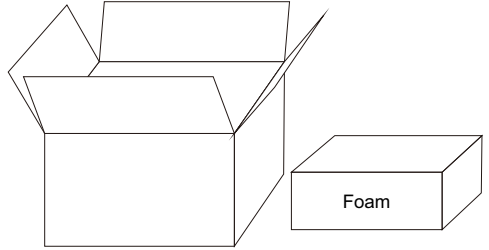
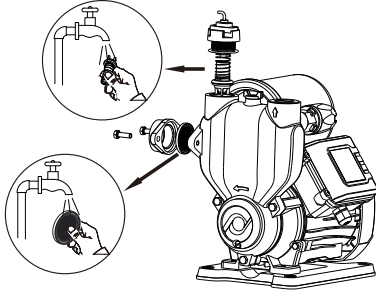

## VIII. Maintenance

1. Regularly check the insulation resistance between the electric pump winding and the stator housing, when it is close to the working environment, the insulation resistance shall not be lower than  $5M\Omega$ , otherwise you must take relative measures and use it when the requirements are reached.
2. Before conducting any maintenance operation, you should cut off the power to ensure that the motor will not operate due to occasional operation.

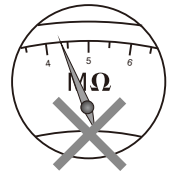
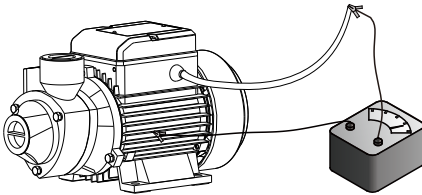

Normal use after 2000 hours, the pump should be sent to the local repair station, according to the following steps of electric pump maintenance, and regular maintenance should be conducted as per the following steps:

Disassembly: Check all wearing parts, such as the bearing, mechanical seal and impeller, flow switch, pressure switch, pressure tank, etc., and conduct replacement timely in case of damage.

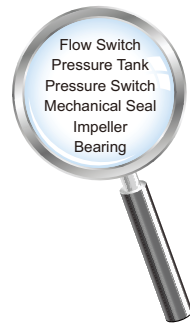
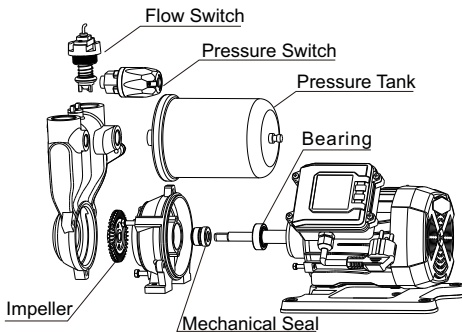

1. When the environment temperature is lower than 4°C, you should empty the water in the pump body for fear of freezing and breaking the pump body. Before starting the electric pump again, you must first check whether the pump shaft rotates flexibly and fill water into the pump body.

2. If the electric pump is not in use for a long time, you shall disassemble the pipelines, empty the water in the pump, clean the main parts and components, conduct rust-proof treatment, place it in a dry and ventilated location and keep it properly.

**Air tight test:** After disassembly or replacement of various sealing units, the pressure-bearing parts and complete machine shall be conducted a water (air) pressure test under the maximum working pressure for 3 minutes and no leakage or sweating phenomena shall occur.

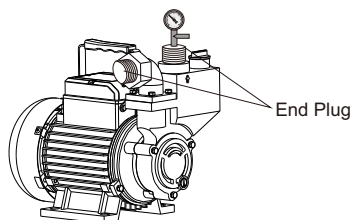

Every three months you use the water pump, you need to check whether the pressure tank is filled with air; if there is no air inside, you need to refill air into the pressure tank as per the pressure marked on the tag of the pressure tank.

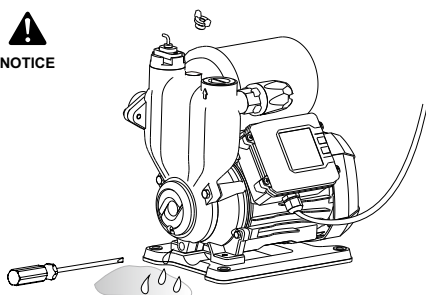
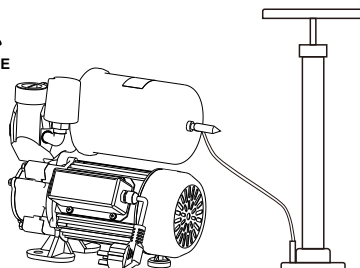

Recycling of the electric pump shall observe the local laws and regulations with regard to recycling and reusing.

## IX. Common Fault Phenomena and Solutions

Fault Phenomena	Main Cause	Solutions
Difficulty in starting	<ol style="list-style-type: none"> <li>1. Low voltage;</li> <li>2. Default phase of the electric pump or breakage of the cable;</li> <li>3. Stuck impeller ;</li> <li>4. Too much voltage reduction of the cable;</li> <li>5. Capacitor damage;</li> <li>6. Burned-out stator winding.</li> </ol>	<ol style="list-style-type: none"> <li>1. Ask the electric power company to solve or add the voltage; regulator and adjust the voltage to 0.9 – 1.1 times of the rated value</li> <li>2. Check the switch wiring terminal and the cable;</li> <li>3. Use the screwdriver to toggle the rotation shaft at the fan end to make it rotate flexibly or disassemble the pump body to clear the debris;</li> <li>4. Thicken the cable properly;</li> <li>5. Send it to the maintenance center to replace the capacitor with one with the same capacitance;</li> <li>6. Send it to the maintenance center to replace the winding coil.</li> </ol>

Fault Phenomena	Main Cause	Solutions
Insufficient flow or pressure	<ol style="list-style-type: none"> <li>1. Wrong pump selection</li> <li>2. Overlong inlet pipeline, over-high head or serious bending of the pipeline</li> <li>3. Insufficient water source</li> <li>4. There are foreign matters blocking the inlet pipeline, filter screen or foot valve</li> <li>5. Serious wearing of the impeller</li> </ol>	<ol style="list-style-type: none"> <li>1. Select correct pump</li> <li>2. Shorten the pipeline, use it within the head application range or make pipeline bend gently</li> <li>3. Check the water source</li> <li>4. Wash and clean the pipeline, filter screen or bottom valve and clear the blocking debris</li> <li>5. Replace the impeller</li> </ol>
The motor runs but no water is discharged	<ol style="list-style-type: none"> <li>1. There is air leakage at the water inlet pipeline</li> <li>2. There is air retained in the pump cavity</li> <li>3. Air enters in through the sealing elements</li> <li>4. The water level of the well is too low</li> <li>5. The foot valve is not opened or seriously blocked; the pipeline resistance is great; the suction height is too high</li> </ol>	<ol style="list-style-type: none"> <li>1. Check whether the water inlet pipelines and joints are sealed well and confirm that the seal is reliable</li> <li>2. Refill water into the pump body and discharge the air</li> <li>3. Adjust or replace the sealing elements with new ones</li> <li>4. Adjust the installation height of the water pump</li> <li>5. Check the flexibility of the foot valve, remove the stopper, try to shorten the water inlet pipeline and reduce the suction height</li> </ol>
The motor does not work	<ol style="list-style-type: none"> <li>1. The protector is disconnected or the fuse is burned out</li> <li>2. The impeller is stuck</li> <li>3. The stator winding is burned out</li> <li>4. The voltage is too low</li> <li>5. The cable is broken</li> </ol>	<ol style="list-style-type: none"> <li>1. Check whether the using head or supply voltage meet the specifications. The motor does not work when it is overheated, if it does not work when it is cooled down, please contact the local retailer</li> <li>2. Clear the debris</li> <li>3. Reinsert and rewind the coils and conduct an overhaul</li> <li>4. Ask the electric power company to solve or add the voltage regulator</li> <li>5. Replace the cable</li> </ol>
The stator winding is burned out	<ol style="list-style-type: none"> <li>1. The supply voltage is too low</li> <li>2. Water enters in the motor, which causes short circuit of the coil</li> <li>3. The impeller is stuck</li> <li>4. The electric pump is started too frequently</li> <li>5. Over-load operation of the electric pump</li> <li>6. Default phase of the three-phase electric pump</li> </ol>	Clear the trouble, disassemble the winding, reinsert and rewind the coil as per the original technical requirements and soak and dry the insulation varnish or send it to the maintenance unit for repair