



IMPUMP[®]
Intelligent Motor Pumps

SERVICE MANUAL

Mini-type Clean-water Centrifugal Electric Pump

Model: HTP, JET



Warning

- Before operation, make sure that electric pump is grounded reliably and leakage protection device is equipped.
- Don't touch electric pump while it is running.
- Don't run electric pump without water.

Contents

I. Safety Precautions	1
II. Product Introduction	2
III. Operating Conditions	2
IV. Technical Parameters	3
V. Pump Wiring Diagram	4
VI. Installation Diagram	4
VII. Instructions for Installation	6
VIII. Maintenance	9
IX. Troubleshooting	10

 Thank you very much for choosing our products, and please read over the Operating Manual and keep it properly before the installation and use. The improper usage may lead to personal injuries and property damages.



- Before operation, make sure that electric pump is grounded reliably and leakage protection device is equipped;
- Don't touch electric pump while it is running;
- Don't run electric pump without water.

Warnings for Children

- Any child or any adult who has any physical, sensory or mental defects or lacks of the relevant experience or knowledge, if supervised or given the method onsafe use of this product as well as knowing the dangers involved, may use this product.
- No child shall play with this product as a toy.
- Without supervision, no child shall be allowed to clean or maintain this product.

Pressure Warning

- The system where a pump lies shall be able to withstand the maximum pressure of the pump.







Electricity Warning

- The electric power system may be used only when it has the safety protection measures specified by the existing provisions of the country where the product is installed.

Modification-related Warning

- Where any electric pump is tampered, modified and/or operates outside the recommended operating scope or goes against any other instruction given in this manual, the manufacturer will not guarantee the correct operation of the electric pump or be responsible for any loss which might be caused by the electric pump.
- The manufacturer refuses to undertake any responsibility for any error which might appear in this manual due to misprint or misreplication. The manufacturer reserves the right to make any modification to the product, which, in its opinion, is necessary or useful, without affecting basic features of the product.

There are such symbols as “Danger”, “Notice”, and “Warning” in this Operating Manual, aiming to guarantee the correct use of the products involved and prevent hazards and damages. Please strictly follow them.

-  **Danger:** Failure to observe the relevant rules will cause an electric shock.
-  **Warning:** Failure to observe the relevant rules will cause serious personal injuries.
-  **Notice:** Failure to observe the relevant rules will cause damage to the relevant product.
-  It means that touch is prohibited.
-  It means the relevant rules shall be observed.
-  It means the prohibited actions.
-  It is a symbol of ground wire in case of an electric shock.

Statement: Any hazard or loss generated by any of the following circumstances where the content hereof is not observed shall not belong to the scope of the Company's quality warranty:

- Any disassembly or repair by any unqualified person or any usage of any water pump hereunder independent of its operating conditions makes the water pump unable to normally operate;

- Any loss is caused by voltage or machinery or a chemical reason; or
- Any environmental pollution caused by the use of any dangerous medium.

I. Safety Precautions

An Electric Pump involved hereunder shall be equipped with a leakage protection device properly and reliable grounding shall be provided at the place where the grounding sign of the Electric Pump or the cable lies (the grounding conductor shall be connected to the terminal marked) and simultaneously the connected power socket shall be reliably grounded as well. As shown in the below figure, the ground wire shall not be connected to a gas pipe, for it may result in an explosive; and the plug shall not be wetted and the power socket shall be located at a place which will not be affected by moisture.

⚠ Electrical connection shall be done by a holder of an electrician license in accordance with the relevant local code and safety standard.

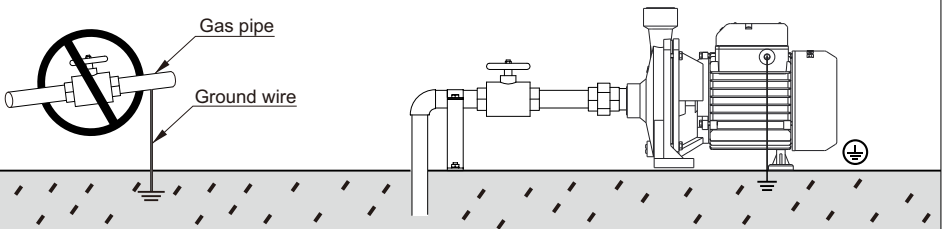

1. When an Electric Pump involved hereunder is working, please first cut off the power supply in case that the Electric Pump is to be relocated or touched; no washing, swimming, or pasturing shall be allowed nearby the working face of the Electric Pump, so as to avoid any accident.
2. During the transportation or installation of an Electric Pump involved, do not grasp the cable to lift the Electric Pump so as to prevent the cable from any damage that may cause electrical leakage or electric shock.
3. Based on the principle of safety, repair or maintenance in any form shall be carried out after the related water pump is powered off.

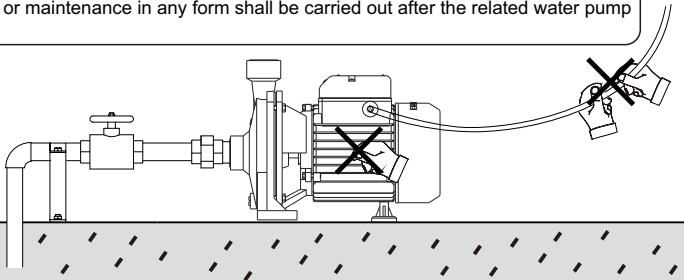

An Electric Pump involved shall only be used to deliver clean water and other liquids whose property is similar to that of clean water and shall not be used to transport any flammable, easily-gasified or explosive liquid, like petroleum or ethyl alcohol, which is very dangerous.

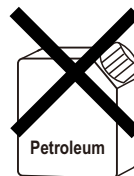
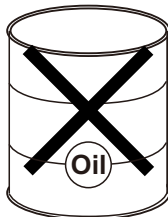

An Electric Pump hereunder shall be installed at a cool and dry place. If it is necessary to arrange such a pump outdoors, please do not expose it to direct sunlight. For exposure to direct sunlight may easily cause accelerated aging and electrical leakage of the water pump. Do not place the Electric Pump horizontally or submerge the Electric Pump in water. Do not spray or splash water or make high-flow water spray on the Electric Pump so as to prevent the winding insulation of the Electric Pump from being damaged by moisture, for a damaged winding insulation may lead to electrical leakage.

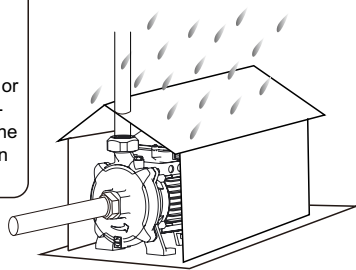

In winter, when anti-freezing measures are taken for a water pump hereunder, no flammable material shall be used to cover the pump or its motor for freeze-proofing, so as to prevent any fire accident. Do not cover the motor with any thermal insulation material, for such a material will lead to bad heat and even a fire easily.

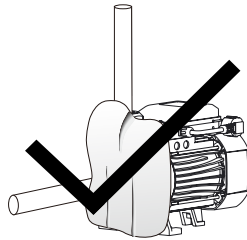
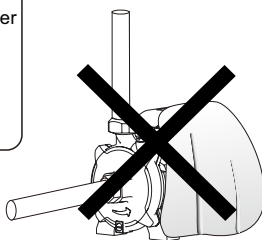

II. Product Introduction

Mini-type Clean-water Centrifugal Electric Pumps include those of the series of HTP/JET (hereinafter referred to as the “Electric Pump”). The Electric Pump is mainly composed of such three parts as the motor, the water pump, and the seal. The motor is an asynchronous motor. The pump adopts the centrifugal-type impeller-volute (guide vane) structure, featured by high water yield and stable operation. The pumps hereunder can be divided into non self-priming pumps and self-priming pumps. The seal: There is a single mechanical seal between the water pump and the motor, used as the motive seal. The water blocking ring revolving on the spindle provides assistance in water throwing and separation and at the place of sealing of each fixed spigot is an O-shaped rubber seal ring used as the static seal.

The Electric Pumps of the models hereunder, with advantages such as small volume, light weight, compact structure, and easy installation, can be widely applied to irrigation and spray irrigation for farms, spray irrigation and watering in gardens, water supply to vegetables greenhouses, water supply and drainage of breeding industry, and lifting of water from wells.

III. Operating Conditions

The Electric Pump shall be able to operate continuously and normally in the following operating conditions:

1. The ambient temperature does not exceed +40°C;
2. The temperature of the medium ranges from 0 to +40°C ;
3. The pH value of the medium is 6.5~8.5;
4. The mass ratio of the solid impurities contained in the medium is not higher than 0.1% and the particle size is not more than 0.2mm
5. The voltage and the frequency of the power supply meet the requirements in the nameplate of the Electric Pump, relating to the nominal voltage and frequency and the scope of the fluctuation of voltage is $\pm 10\%$ of the nominal value.

IV. Technical Parameters - HTP

Table 1

Model		Power		Max Flow (L/min)	Max Head (m)	Head Range (m)	Max Suction (m)
		kW	HP				
50Hz	HTP 25/0.55	0.55	0.75	90	44	4~44	7
	HTP 25/0.75	0.75	1	150	45	4~45	

Table 2(Single-Phase Current Reference Table)

Power (kW)	I(A)						
	110V	115V	120V	127V	220V	230V	240V
0.55	7.8	7.4	7.1	6.7	3.9	3.7	3.6
0.75	10.3	9.8	9.4	8.9	5.2	4.9	4.7

IV. Technical Parameters - JET

JET (S) 370 G2

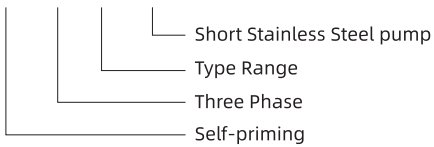

Model	Power		Max. Flow (m ³ /h)	Max. Head (m)	Head Range (m)	Max. Suction (m)
	kW	HP				
JET (S) 250G2	0.25	0.34	2.7	28	4~28	8
JET (S) 370G2	0.37	0.5	2.8	32	5~32	7
JET (S) 550G2	0.55	0.75	3.5	38	4~38	9
JET (S) 750G2	0.75	1	3.5	44	5.5~44	9
JET (S) 1100G2	1.1	1.5	4.2	48	9~48	9

V. Pump Wiring Diagram

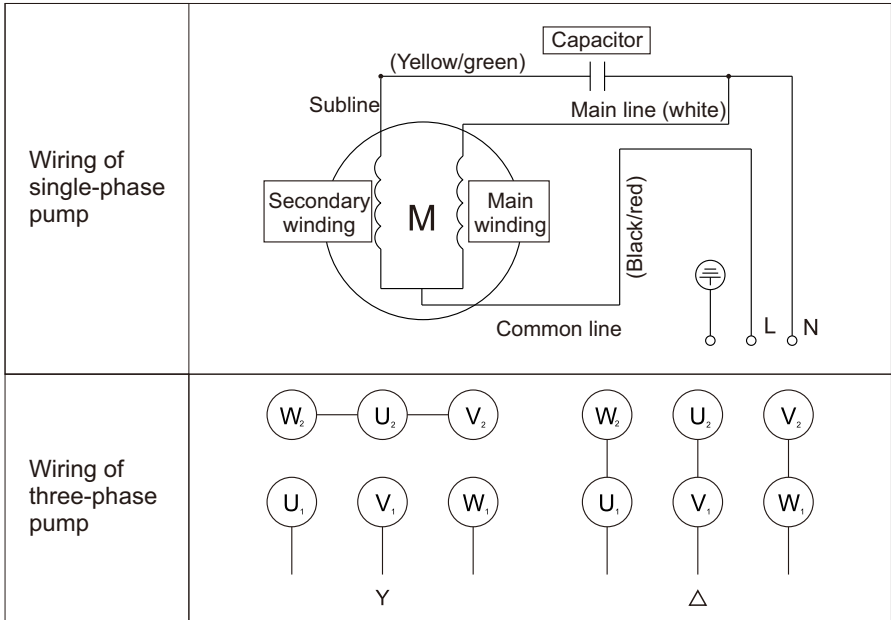

VI. Installation Diagram

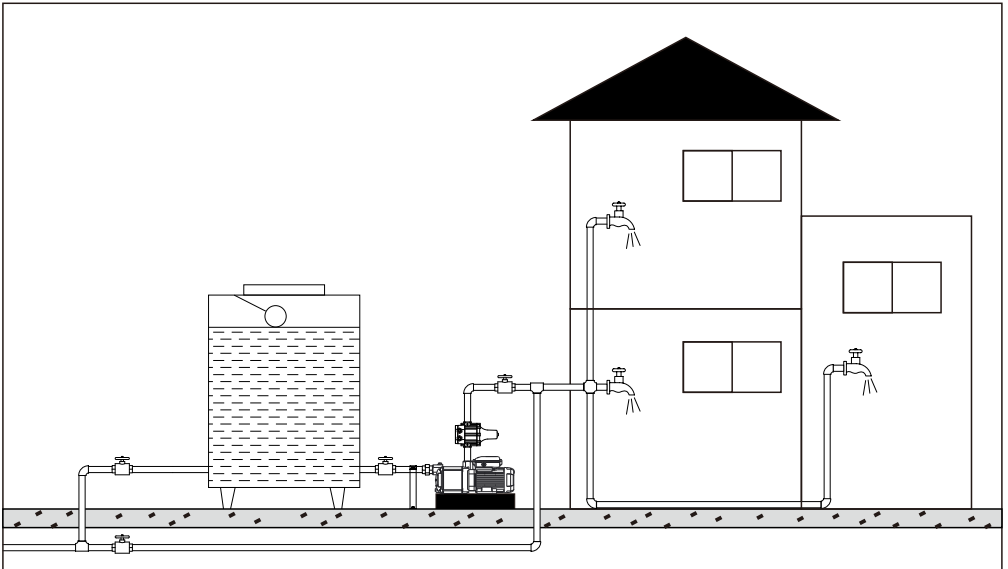

Indirectly-pressurized Supply of Tap Water

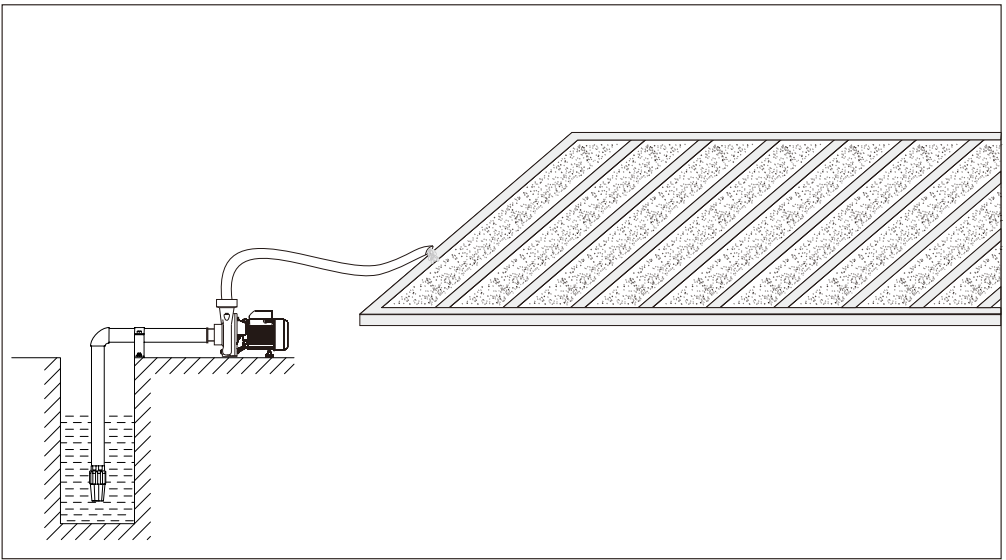

Farm Irrigation

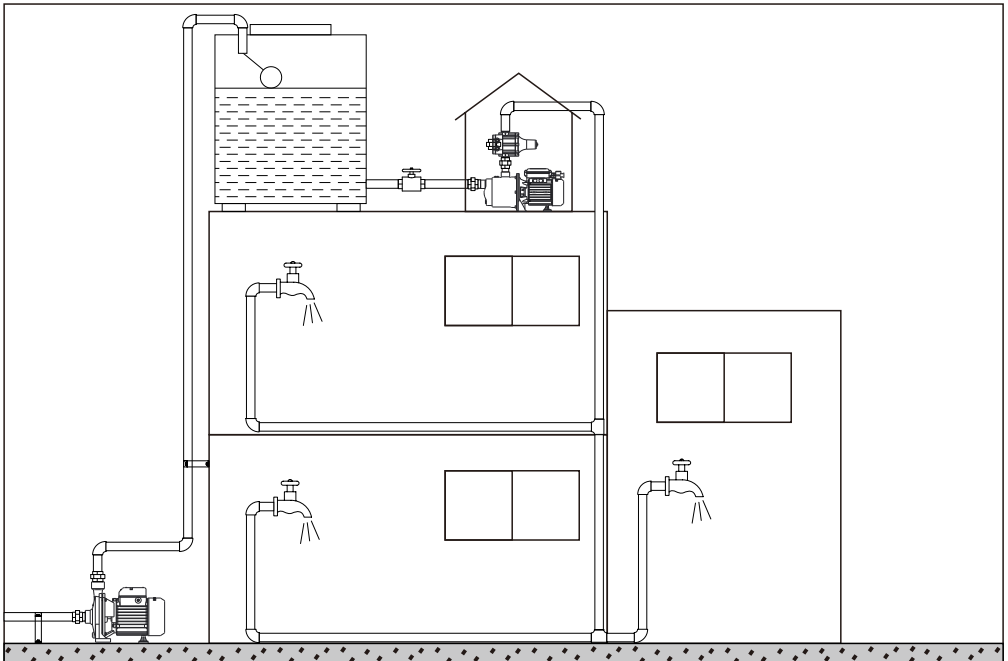

Water Supply by Water Tower on Roof and Downward Pressurization of Water Tower

VII. Instructions for Installation

Prior to installation and use, please fully check whether the Electric Pump is damaged during transportation or storage, for example, whether any cable or outgoing line or plug (if provided) is in a perfect condition. In case of any damage, please have a specialized person make replacement or repair. The insulation resistance shall be greater than $50M\Omega$.

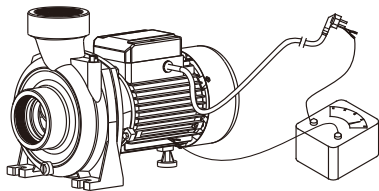

WARNING

During installation, the complete machine shall be fixed and the inlet and outlet pipes shall be separately supported, whose weight shall not be completely supported by the pump body.

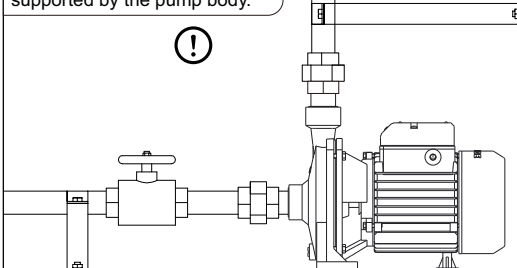

1. Use a steel or rubber pipe (which shall not be too soft so as to avoid becoming flat in case of absorption) to connect the bottom valve and the inlet end of the Electric Pump. Please make sure that the inlet pipeline and its connections are sealed and present no air leakage.

2. Connect the outlet pipe firmly to prevent water from splashing on the motor and hence causing electrical leakage of the Electric Pump. When a rubber pipe is used, pay attention to its temperature resistance limit to ensure that the pipe will not be deformed by heat, for such deformation might make the pipe become broken and hence causing water leakage.

3. After connecting the upper end of the inlet pipe and the inlet end of the Electric Pump, please make sure the end of the inlet pipe, where the bottom valve and the strainer lie, is submerged in water. To guarantee the reliable use of the Electric Pump, please arrange an effective strainer which, together with the bottom valve, shall keep more than 30cm away from the water bottom, for the purpose of preventing sludge or impurities from being absorbed to the pump chamber and hence affecting the operation of the pump.

4. Make a pipe as short as possible to reduce connections. The drawing-up height shall not exceed the suction lift.

1. During usage, pay attention to the decline of the water level. Do not let the bottom valve or the lower end of the inlet pipe come out of water.

2. When the inlet pipe is installed, please note that the height of the inlet pipe shall not exceed that of the inlet of the water pump, or otherwise it will be difficult for the pump to absorb water.

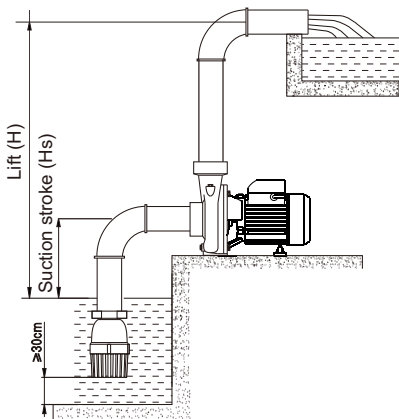
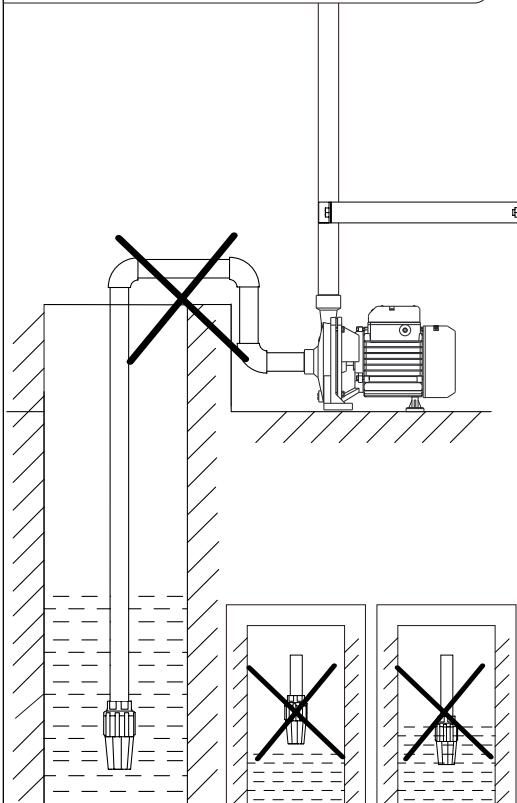

Prior to the initial use, please fill the chamber of the Electric Pump with water and then power on it so as to avoid dry running.

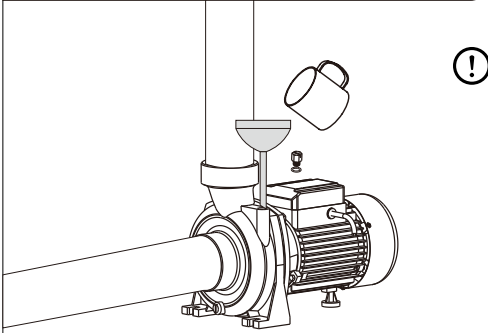

In an area with high sand content, it is recommended that a Y-shaped filter should be installed at the inlet pipe to prevent sand from entering the pump chamber and hence causing a worn or blocked impeller.

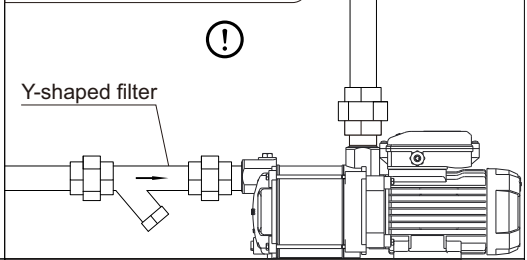

Install the Electric Pump as a dry and well-ventilated place where repair and inspection can be carried out easily. To install the Electric Pump at a narrow place, please follow the following diagram and make the fan cover keep more than 25cm away from the wall, in favor of heat dissipation.

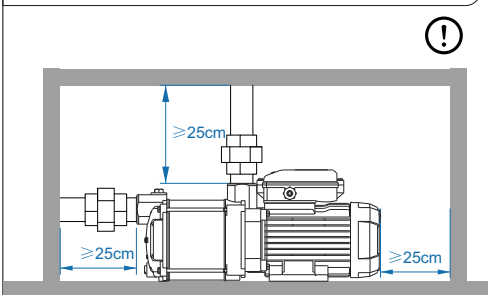

Arrange a drainage ditch around the Electric Pump to form natural drainage and prevent water leakage and loss during the usage, repair, or replacement of the Electric Pump (especially at a basement, kitchen, or stairway).

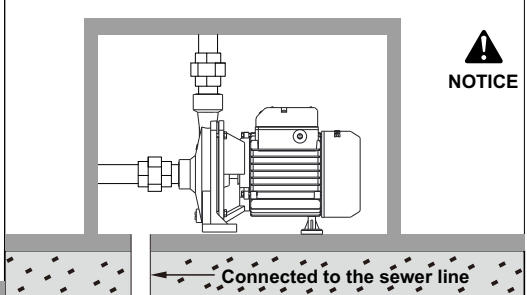

If the user wants to make the Electric Pump do automatic control, a proper pressure control device shall be arranged on the outlet pipe only.

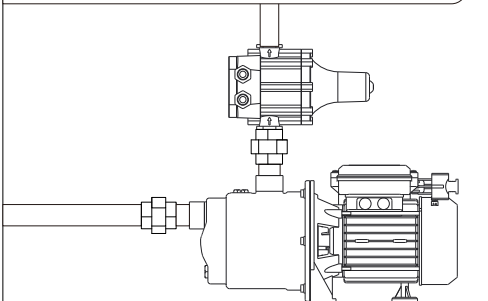

To equip a three-phase electric pump with an overload protection device, a suitable overload protection device shall be selected on the basis of current or power.

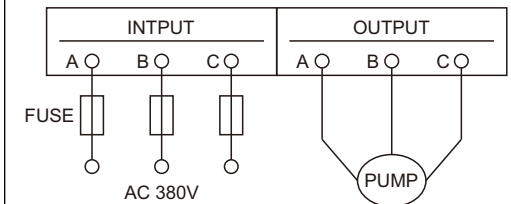

To adjust the pressure switch, open the housing of the pressure switch by using a slot-type screwdriver or wrench to rotate the pressure adjusting screw toward “+”.

A non-specialized person shall adjust the switch under the condition of power-off and a specialized person shall take safety protection measures in case of operation under power-on.

WARNING

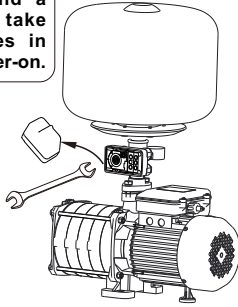
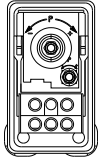

To add a wire for the plug or replace the wire, please use a wire whose specifications are the same or higher than those of the original wire and pay attention to making firm connections, water-proofing and insulation.

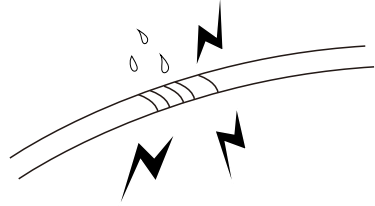

Prior to the use of the Electric Pump, please carry out a test run of which the duration shall not exceed 10s, as long-time dry running will damage the mechanical seal. In case of a three-phase pump, please check whether the rotational direction is the same as the rotation mark. When finding the reverse rotation of the Electric Pump, immediately cut off the power supply and exchange any two phases of the three-phase pump.

With the valve closed at the outlet, the Electric Pump shall not operate for over 5 minutes. Where the Electric Pump operates with no water flow change inside the pump body, resulting in the rise of the temperature and the pressure of the liquid in the pump body, leakage may be caused or the pump or pipeline may be damaged

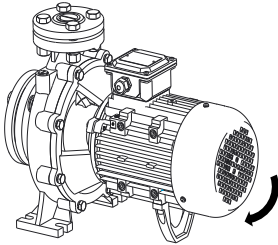

NOTICE

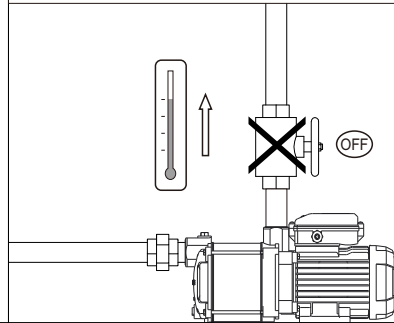

The packing materials removed after installation and use shall be disposed in accordance with the concerned local law.

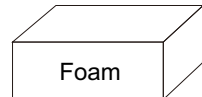
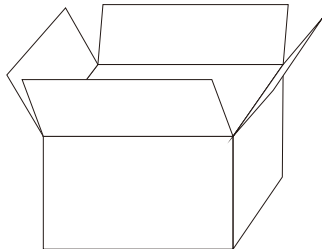

VIII. Maintenance

1. Regularly inspect the insulation resistance between the enclosure and the winding of the Electric Pump, which shall be no less than $5M\Omega$ when the operating temperature is nearly achieved, or otherwise usage shall not be allowed until the corresponding measures are taken and the relevant requirements are met.
2. Prior to any repair or maintenance operation, please cut off the power supply and make sure that the motor will not be powered on for operation due to a casual operation.

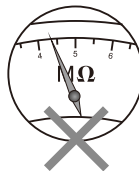
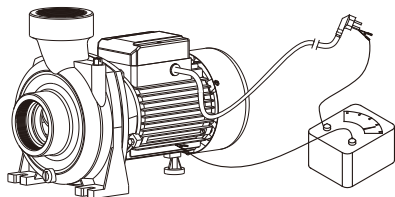

After the 2000-hour normal usage of the Electric Pump, the Electric Pump shall be delivered to a qualified repair station for maintenance and repair as per the steps below: dismantle the pump and inspect various quick-wear parts such as the bearing, mechanical seal, impeller, and bottom valve. Please immediately replace those damaged ones

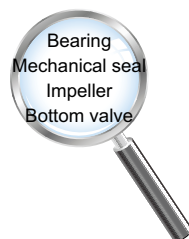
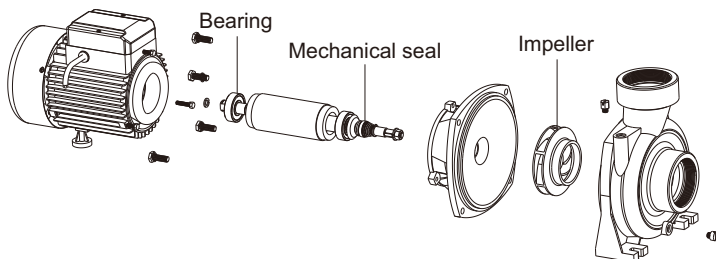

1. When the ambient temperature is lower than 4°C , please completely drain the water accumulated in the pump chamber to avoid frost-cracking the pump body. Before starting the Electric Pump again, inspect whether the pump spindle rotates flexibly and fill the pump chamber with water.
2. In the Electric Pump has not been used for a long time, please disassemble the piping, drain the water accumulated in the pump, clean the main parts and components, carry out rust-proof treatment, and keep it properly at a dry and well-ventilated place.

Air tight test: After the pump is disassembled for the repair or replacement of any seal, the bearers and the complete pump shall go through water (air) pressure tests on the basis of the maximum operating pressure and such a test shall last for 3 minutes and there shall be no phenomenon of leakage or sweating.

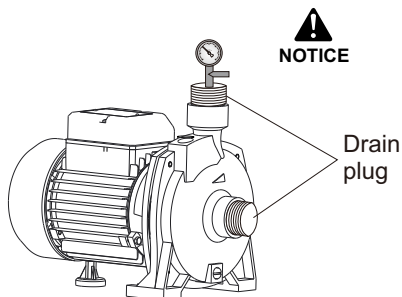
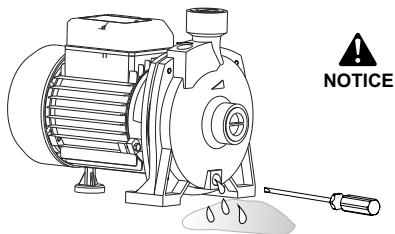

- The recycling of the Electric Pump shall comply with the local laws and regulations concerning recycling.

IX. Troubleshooting

Fault	Cause	Remedy
The motor does not revolve.	<ol style="list-style-type: none"> 1. The cable of the Electric Pump is connected badly or broken. 2. The impeller is blocked. 3. The stator winding is burnt. 4. The voltage is low. 5. The voltage of the cable drops too much. 6. The capacitor is damaged. 	<ol style="list-style-type: none"> 1. Inspect the terminal or replace the cable. 2. Correct the blocked part or remove sundries. 3. Re-insert the winding or carry out overhaul. 4. Adjust the supply voltage to a value within the range of 0.9-1.1 times the rating. 5. Thicken the cable as required. 6. Replace the damaged capacitor with another
The motor operates but the water pump has no water flow.	<ol style="list-style-type: none"> 1. There is air leakage at the inlet pipe. 2. The bottom valve or check valve is not opened or is blocked. 3. Air gets in through the seal. 4. The water level is lower than the suction lift limit of the Electric Pump. 5. The water pump is not filled with water. 6. The impeller is damaged. 7. There is a high pipe resistance and an ill-suited pump model selected is not suitable. 	<ol style="list-style-type: none"> 1. Check whether the sealing at the inlet pipe or any connection is perfect and ensure that the sealing is reliable. 2. Inspect the flexibility of the bottom valve and the check valve, and remove obstacles. 3. Adjust or replace the seal. 4. Check the water level and adjust the installation height of the Electric Pump. 5. Again fill the pump body with water. 6. Replace the impeller. 7. Reduce the bends of the pipeline and re-select a model.
The flow is insufficient.	<ol style="list-style-type: none"> 1. The pipeline is too long or bent too much, or the lift is too high. 2. The bottom valve, strainer or impeller is blocked locally. 3. The impeller is seriously worn. 4. The motor revolves reversely. 5. The water level is low and close to the suction lift limit of the Electric Pump. 	<ol style="list-style-type: none"> 1. Shorten the pipeline, use the Electric Pump within its range of lift or make the bending of the pipeline gentle. 2. Clear away sundries. 3. Replace the impeller. 4. Exchange any two phases of the three-phase power supply. 5. Reduce the installation height of the Electric Pump.
The Electric Pump stops running suddenly.	<ol style="list-style-type: none"> 1. The protector is disconnected or the fuse is burnt. 2. The impeller is blocked. 3. The stator winding is burnt out. 	<ol style="list-style-type: none"> 1. Inspect whether the lift or supply voltage used complies with the relevant provisions and make an adjustment accordingly. 2. Clear away sundries. 3. Re-insert the winding or carry out overhaul.
The stator winding is burnt.	<ol style="list-style-type: none"> 1. The supply voltage is too low. 2. Water gets into the motor, which leads to interturn or interphase short circuit. 3. The impeller is blocked. 4. The Electric Pump starts frequently. 5. The Electric Pump works overload operation. 	<p>Do troubleshooting, disassemble the winding and re-insert the winding as per the concerned technical requirements as well as immerse and dry the insulating varnish or deliver the winding to the repair station for repair.</p>

Notes:

1. All the diagrams in this Operating Manual are only for reference and the Electric Pump you purchased and its accessories may be different from those indicated in this Operating Manual. Your understanding is really appreciated.
2. The products involved hereinbefore are subject to continuous improvements and changes (including its appearance and color)without further notice, please in kind prevail.