

GLASTONBURY SOUTHERN GAGE™

1955

"HELPING COMPANIES MEASURE THEIR SUCCESS"

2018

PRICE BOOK



Over 4,000 Thread Items
in Stock



2018



Need it fast?
Redline Service
available



www.gsgage.com



GSG...YOUR SOURCE FOR SPECIAL GAGES

MOBILE FRIENDLY, JUST SCAN THE CODES ON THE PAGES FOR
ADDITIONAL PRODUCT INFO



GLASTONBURY SOUTHERN GAGE™

GLASTONBURY SOUTHERN GAGE
46 INDUSTRIAL PARK ROAD
ERIN, TN 37061
Ph; 800-251-4243

WWW.GSGAGE.COM



GLASTONBURY SOUTHERN GAGE
87 UPTON ROAD
COLCHESTER, CT 06415
Ph; 860-537-7340



Gages manufactured from many materials including Steel, Stainless & Carbide



Need it fast?
Redline Service
available



www.gsgage.com



GSG...YOUR SOURCE FOR SPECIAL GAGES

MOBILE FRIENDLY, JUST SCAN THE CODES ON THE PAGES FOR
ADDITIONAL PRODUCT INFO



Table of Contents

Products	Price List Page #
Certifications of New Product Calibration Service	2 2
Thread Work Plugs	
Taperlock Style	
Steel	3 - 4
Chrome	5 - 6
Reversible Style	
Steel	7
Chrome	8
Thread Rings	
True Round (Southern Style)	9 - 10
AGD Style	11 - 12
Thread Set Plug Gages	13 - 14
Tapered Pipe Thread Gages	15-16
Helical Coil (STI) Thread Work Plugs	17
Hole Location Plugs (Flex Plugs)	18
Snap Gages	19
Cylindrical Gages/Masters	
Ring Gages	20 - 21
Master Discs	22 - 23
Reversibles	24 - 26
Taperlocks/Trilocks	27 - 29
Progressives	29
Cylindrical Taper Gages	30
Cylindrical Taper Gage RFQ Form	31
Surveillance Masters	
Micrometer Set Masters	32
Vernier Caliper Masters	32
Depth Micrometer Masters	33
QUICKCHEK Masters	33
Geometric Chek Master	33
Z Axis Chek Masters	33
Variable Thread Gaging Systems	
For External Product	
Full Form Master Set Plugs	34
TRI-ROLL Systems	35-36
STC Segment Systems	37
For Internal Product	
ITC Segment Systems	37-38
Master Setting Rings	38
Zero Spindle System	39
Digital Chamfer Gages	40-41
Chamfer Ring Masters	42
Medical Gages	43

Index

Alphabetical Listing of Products	Price List Page #
BSP Gages	16
Certification of New Product	2
Certifications Service	2
Chamfer Gages	40-41
Chamfer Ring Masters	42
Cylindrical Gages/Masters	20-29
Cylindrical Taper Gages	30
Depth Micrometer Masters	33
Flex Plugs (Hole Location Gages)	18
Full Form Set Plugs	34
Geometric Chek Master	33
Helical (STI) Thread Work Plugs	17
Hexalobe Gages	43
Hole Location Plugs (Flex Plugs)	18
ITC Segment Systems	37-38
Master Discs	22-23
Micrometer Set Masters	32
Progressives	29
QUICKCHEK Masters	33
Reversibles, Cylindrical	24-26
Ring Gages, Cylindrical	20-21
Solid Master Thread Set Rings	38
Snap Gages	19
STC Segment Systems	37
Surveillance Masters	32-33
Tapered Pipe Thread Gages	15-16
Taper Gages, Cylindrical	30
Taperlocks/Trilocks, Cylindrical	27-29
Thread Rings, AGD Style	11-12
Thread Rings, True Round (Southern Style)	9-10
Thread Set Plug Gages, truncated	13-14
Thread Work Plugs	3 - 8
TRI-ROLL Systems	35-36
Variable Thread Gaging Systems	34-38
Vernier Caliper Masters	32
Wire Style, Cylindrical Reversible	24-26
Z Axis Chek Masters	33
Zero Spindle System	39

Prices subject to change without notice.

Unless otherwise specified, GSG gages will be supplied with the following standard practices.

Edges broken with Radius or chamfers of .005" to .020" (0.13mm to 0.51mm). Special markings: Go/NoGo sizes, class and tool number are permanently marked at no extra charge. Additional markings are \$.25 per character.

Warranty: Glastonbury Southern Gage warrants all gages for 30 days from date of shipment except in cases of obvious customer abuse and mishandling. GSG offers no further warranties, expressed or implied and its responsibilities due to any defects of inaccuracies in any gage or certificate shall, in no event nor for any cause whatsoever exceed the purchase price.

MINIMUM ORDER VALUE \$75.00



Visit Glastonbury Southern Gage on-line by scanning this code

MOBILE FRIENDLY, JUST SCAN THE CODES ON THE PAGES





CERTIFICATIONS



CERTIFICATION for NEW PRODUCT			GAGE INSPECTION SERVICE - CUSTOMER PROPERTY All Customer Property A2LA Certified	
	A2LA Price	Standard Price		A2LA Price
Thread Work Plug Gages			Thread Work Plug Gages	
#0 to 1 1/2" Taperlock	\$ 30.00	\$ 18.00	#0 to 1.5" Taperlock	\$ 58.00
3/4 to 13" Trilock	\$ 36.00	\$ 18.00	3/4 to 13" Trilock	\$ 70.00
Thread Ring Gages			Thread Ring Gages (With Set Plugs available)	
Standard Size 0 to 1 1/2	\$ 44.00	\$ 18.00	Standard Size 0 to 1 1/2	\$ 70.00
Non - Standard Sizes #0 to 5 inch	\$ 44.00	\$ 18.00	Non - Standard Sizes #0 to 5 inch	\$ 87.00
Non - Standard Sizes over 5 inch	\$ 63.00	\$ 18.00	Non - Standard Sizes over 5 inch	\$ 130.00
Thread Set Plugs Gages			Thread Set Plugs Gages	
#0 to 1 1/2" Taperlock	\$ 31.00	\$ 18.00	#0 to 1 1/2" Taperlock	\$ 62.00
3/4 to 13" Trilock	\$ 38.00	\$ 18.00	3/4 to 13" Trilock	\$ 76.00
Tapered Pipe Gages			Tapered Pipe Gages (NPT, NPTF, ANPT)	
1/16 to 3" Plug	\$ 50.00	\$ 30.00	1/16 to 3" Plug	\$ 58.00
1/16 to 3" Ring	\$ 50.00	\$ 30.00	1/16 to 3" Ring	\$ 75.00
3 1/2 to 6" Plug	\$ 50.00	\$ 30.00	3 1/2 to 6" Plug	\$ 77.00
3 1/2 to 6" Ring	\$ 50.00	\$ 30.00	3 1/2 to 6" Ring	\$ 90.00
Other Tapered Threads Contact Factory.				
Cylindrical Rings, Master Discs & Plug Gages			Cylindrical Rings, Master Discs & Plug Gages	
*.015 to .040 Rings	*	\$ 180.00	*.015 to .040 Rings	\$ 180.00
.015 to .040 Plugs	\$ 49.00	\$ 40.00	.015 to .040 Plugs	\$ 82.00
.0401 to .365	\$ 30.00	\$ 18.00	.0401 to .365	\$ 82.00
.3651 to 2.500	\$ 30.00	\$ 18.00	.3651 to 2.500	\$ 65.00
2.5001 to 5.510	\$ 43.00	\$ 33.00	2.5001 to 5.510	\$ 85.00
5.5101 to 11.000	\$ 65.00	\$ 55.00	5.5101 to 11.000	\$ 100.00
11.0001 to 15.000	\$ 85.00	\$ 65.00	11.0001 to 15.000	\$ 130.00
15.0001 to 22.000	\$ 145.00	\$ 85.00	15.0001 to 22.000	\$ 215.00
22.0001 and up Call Factory			* 22.0001 and up Call Factory	
Roundness Charts			* Roundness Charts	
First Trace	N/A	\$ 80.00	First Trace	\$ 80.00
Each Additional Trace	N/A	\$ 60.00	Each Additional Trace	\$ 60.00
Cylindrical Taper Gages			Cylindrical Taper Gages	
Standard Tapers, Tapers with Specs	N/A	\$ 60.00	* Standard Tapers, Tapers with Specs	\$ 120.00
			* Special Tapers without B/P or Specs (Subject to size consideration)	\$ 170.00
Snap Gages	N/A	\$ 60.00	Snap Gages	\$ 60.00
Surveillance Masters			Surveillance Masters	
01-1 English or Metric	\$ 125.00	\$ 90.00	01-1 English or Metric	\$ 165.00
16-1 English or Metric	\$ 125.00	\$ 90.00	16-1 English or Metric	\$ 160.00
16-1/2 English or Metric	\$ 250.00	\$ 180.00	16-1/2 English or Metric	\$ 300.00
112 English or Metric	\$ 300.00	\$ 220.00	112 English or Metric	\$ 315.00
VC-1 English or Metric	\$ 125.00	\$ 90.00	VC-1 English or Metric	\$ 160.00
DM-1 English or Metric	\$ 125.00	\$ 90.00	DM-1 English or Metric	\$ 160.00
ADM - English or Metric	\$ 255.00	\$ 225.00	ADM - English or Metric	\$ 280.00
QUIKCHEK			QUIKCHEK	
8"	Included		8"	\$ 325.00
16"	Included		16"	\$ 440.00
* GEOMETRIC CHEK	N/A	Included	* GEOMETRIC CHEK	\$ 200.00
Z AXIS CHEK	Included		Z AXIS CHEK	\$ 100.00
Thread Wires			Thread Wires	
Standard sizes	\$60.00/set		Standard sizes	\$60.00/Set

* Items or features of item may be outside of Accreditation scope.

**TAPERLOCK
THREAD WORK PLUG GAGES
STEEL**

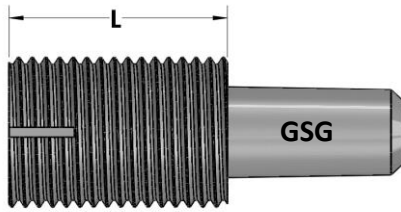

GO

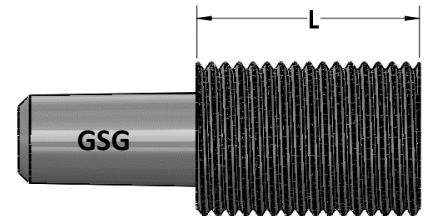

NO-GO

All GSG Thread Work Plug Gages are manufactured to ASME/ANSI B1.2 or B1.16M. Taperlock style up to 1.5 inch / M36, above are trilock style. Chip grooves are provided on all Go work plug members #10 / M4 and larger. All gages are made of oil hardened tool steel.

METRIC

Nominal Size	Go Class 6H EDP #	Go Length "L"	NoGo Class 6H EDP #	NoGo Length "L"	Member Price	Handle EDP #	Handle #	Handle Price	Double End Go/NoGo/Hdle Price
M1.6 x 0.35	TPS200002	1/4	TPS200001	3/16	\$ 54.00	HDL000001	000	\$ 11.00	\$ 119.00
M1.8 x 0.35	TPS200004	1/4	TPS200003	3/16	\$ 54.00	HDL000001	000	\$ 11.00	\$ 119.00
M2.0 x 0.40	TPS200006	1/4	TPS200005	3/16	\$ 54.00	HDL000001	000	\$ 11.00	\$ 119.00
M2.2 x 0.45	TPS200008	1/4	TPS200007	3/16	\$ 54.00	HDL000001	000	\$ 11.00	\$ 119.00
M2.5 x 0.45	TPS200010	1/4	TPS200009	3/16	\$ 51.00	HDL000001	000	\$ 11.00	\$ 113.00
M3.0 x 0.50	TPS200012	5/16	TPS200011	7/32	\$ 51.00	HDL000002	00	\$ 11.00	\$ 113.00
M3.5 x 0.60	TPS200014	5/16	TPS200013	7/32	\$ 43.00	HDL000002	00	\$ 11.00	\$ 97.00
M4.0 x 0.70	TPS200016	13/32	TPS200015	9/32	\$ 43.00	HDL000003	0	\$ 11.00	\$ 97.00
M4.5 x 0.75	TPS200018	13/32	TPS200017	9/32	\$ 43.00	HDL000003	0	\$ 11.00	\$ 97.00
M5.0 x 0.80	TPS200020	13/32	TPS200019	9/32	\$ 43.00	HDL000003	0	\$ 11.00	\$ 97.00
M6.0 x 1.00	TPS200022	1/2	TPS200021	5/16	\$ 33.00	HDL000004	1	\$ 10.00	\$ 76.00
M7.0 x 1.00	TPS200024	1/2	TPS200023	5/16	\$ 33.00	HDL000004	1	\$ 10.00	\$ 76.00
M8.0 x 1.25	TPS200027	1/2	TPS200025	5/16	\$ 33.00	HDL000004	1	\$ 10.00	\$ 76.00
M8.0 x 1.00	TPS200028	1/2	TPS200026	5/16	\$ 33.00	HDL000004	1	\$ 10.00	\$ 76.00
M10.0 x 1.00	TPS200034	3/4	TPS200031	3/8	\$ 33.00	HDL000009	2	\$ 10.00	\$ 76.00
M10.0 x 1.50	TPS200032	3/4	TPS200029	3/8	\$ 35.00	HDL000009	2	\$ 10.00	\$ 80.00
M10.0 x 1.25	TPS200033	3/4	TPS200030	3/8	\$ 35.00	HDL000009	2	\$ 10.00	\$ 80.00
M12.0 x 1.75	TPS200039	3/4	TPS200035	3/8	\$ 40.00	HDL000009	2	\$ 10.00	\$ 90.00
M12.0 x 1.50	TPS200040	3/4	TPS200036	3/8	\$ 40.00	HDL000009	2	\$ 10.00	\$ 90.00
M12.0 x 1.25	TPS200041	3/4	TPS200037	3/8	\$ 42.00	HDL000009	2	\$ 10.00	\$ 94.00
M12.0 x 1.00	TPS200042	3/4	TPS200038	3/8	\$ 46.00	HDL000009	2	\$ 10.00	\$ 102.00
M14.0 x 2.00	TPS200046	7/8	TPS200043	1/2	\$ 45.00	HDL000014	3	\$ 10.00	\$ 100.00
M14.0 x 1.50	TPS200047	7/8	TPS200044	1/2	\$ 45.00	HDL000014	3	\$ 10.00	\$ 100.00
M14.0 x 1.00	TPS200048	7/8	TPS200045	1/2	\$ 45.00	HDL000014	3	\$ 10.00	\$ 100.00
M15.0 x 1.00	TPS200050	7/8	TPS200049	1/2	\$ 45.00	HDL000014	3	\$ 10.00	\$ 100.00
M16.0 x 2.00	TPS200053	7/8	TPS200051	1/2	\$ 45.00	HDL000014	3	\$ 10.00	\$ 100.00
M16.0 x 1.50	TPS200054	7/8	TPS200052	1/2	\$ 45.00	HDL000014	3	\$ 10.00	\$ 100.00
M17.0 x 1.00	TPS200056	7/8	TPS200055	1/2	\$ 47.00	HDL000014	3	\$ 10.00	\$ 104.00
M18.0 x 2.50	TPS200059	7/8	TPS200058	1/2	\$ 50.00	HDL000014	3	\$ 10.00	\$ 110.00
M18.0 x 1.50	TPS200060	7/8	TPS200057	1/2	\$ 50.00	HDL000014	3	\$ 10.00	\$ 110.00
M20.0 x 2.50	TPS200063	7/8	TPS200061	1/2	\$ 63.00	HDL000014	3	\$ 10.00	\$ 136.00
M20.0 x 1.50	TPS200064	7/8	TPS200062	1/2	\$ 55.00	HDL000014	3	\$ 10.00	\$ 120.00
M22.0 x 2.50	TPS200067	1	TPS200065	5/8	\$ 55.00	HDL000019	4	\$ 11.00	\$ 121.00
M22.0 x 1.50	TPS200068	1	TPS200066	5/8	\$ 55.00	HDL000019	4	\$ 11.00	\$ 121.00
M24.0 x 3.00	TPS200072	1	TPS200069	5/8	\$ 63.00	HDL000019	4	\$ 11.00	\$ 137.00
M24.0 x 2.00	TPS200071	1	TPS200070	5/8	\$ 63.00	HDL000019	4	\$ 11.00	\$ 137.00
M27.0 x 3.00	TPS200076	1	TPS200073	5/8	\$ 84.00	HDL000019	4	\$ 11.00	\$ 179.00
M27.0 x 2.00	TPS200075	1	TPS200074	5/8	\$ 84.00	HDL000019	4	\$ 11.00	\$ 179.00
M30.0 x 3.50	TPS200082	1 1/4	TPS200077	3/4	\$ 101.00	HDL000024	5	\$ 12.00	\$ 214.00
M30.0 x 2.00	TPS200080	1	TPS200078	3/4	\$ 101.00	HDL000024	5	\$ 12.00	\$ 214.00
M30.0 x 1.50	TPS200081	1	TPS200079	3/4	\$ 101.00	HDL000024	5	\$ 12.00	\$ 214.00
M33.0 x 3.50	TPS200086	1 1/4	TPS200083	3/4	\$ 101.00	HDL000024	5	\$ 12.00	\$ 214.00
M33.0 x 2.00	TPS200085	1	TPS200084	3/4	\$ 101.00	HDL000024	5	\$ 12.00	\$ 214.00
M35.0 x 1.50	TPS200090	1	TPS200088	3/4	\$ 109.00	HDL000024	5	\$ 12.00	\$ 230.00
M36.0 x 4.00	TPS200093	1 1/4	TPS200087	3/4	\$ 114.00	HDL000024	5	\$ 12.00	\$ 240.00
M36.0 x 3.00	TPS200094	1 1/4	TPS200089	3/4	\$ 114.00	HDL000024	5	\$ 12.00	\$ 240.00
M36.0 x 2.00	TPS200092	1	TPS200091	3/4	\$ 114.00	HDL000024	5	\$ 12.00	\$ 240.00
M39.0 x 4.00	TPS200099	1 7/8	TPS200095	7/8	\$ 128.00	HDL000023	5 1/2	\$ 16.00	\$ 272.00
M39.0 x 3.00	TPS200100	1 1/4	TPS200096	7/8	\$ 128.00	HDL000023	5 1/2	\$ 16.00	\$ 272.00
M39.0 x 2.00	TPS200098	1 1/4	TPS200097	7/8	\$ 123.00	HDL000023	5 1/2	\$ 16.00	\$ 262.00

**TAPERLOCK
THREAD PLUG GAGES
STEEL**

Nominal Size	Go Basic 2B or 3B EDP #	Go Length "L"	NoGo Class 2B EDP #	NoGo Class 3B EDP #	INCH		Member Price	Handle EDP #	Handle #	Handle Price	Double End Go/NoGo/Hdle Price
					NoGo Length "L"						
0-80 (.060) UNF	TPS100001	1/4	TPS100002	TPS100003	3/16		\$ 52.00	HDL000001	000	\$ 11.00	\$ 115.00
1-64 (.073) UNC	TPS100238	1/4	TPS100239	TPS100240	3/16		\$ 52.00	HDL000001	000	\$ 11.00	\$ 115.00
1-72 (.073) UNF	TPS100004	1/4	TPS100005	TPS100006	3/16		\$ 52.00	HDL000001	000	\$ 11.00	\$ 115.00
2-56 (.086) UNC	TPS100010	1/4	TPS100011	TPS100012	3/16		\$ 50.00	HDL000001	000	\$ 11.00	\$ 111.00
2-64 (.086) UNF	TPS100007	1/4	TPS100008	TPS100009	3/16		\$ 50.00	HDL000001	000	\$ 11.00	\$ 111.00
3-48 (.099) UNC	TPS100016	1/4	TPS100017	TPS100018	3/16		\$ 45.00	HDL000001	000	\$ 11.00	\$ 101.00
3-56 (.099) UNF	TPS100013	1/4	TPS100014	TPS100015	3/16		\$ 45.00	HDL000001	000	\$ 11.00	\$ 101.00
4-40 (.112) UNC	TPS100025	5/16	TPS100026	TPS100027	7/32		\$ 40.00	HDL000002	00	\$ 11.00	\$ 91.00
4-48 (.112) UNF	TPS100019	5/16	TPS100020	TPS100021	7/32		\$ 42.00	HDL000002	00	\$ 11.00	\$ 95.00
5-40 (.125) UNC	TPS100028	5/16	TPS100029	TPS100030	7/32		\$ 37.00	HDL000002	00	\$ 11.00	\$ 85.00
5-44 (.125) UNF	TPS100022	5/16	TPS100023	TPS100024	7/32		\$ 37.00	HDL000002	00	\$ 11.00	\$ 85.00
6-32 (.138) UNC	TPS100037	5/16	TPS100038	TPS100039	7/32		\$ 33.00	HDL000002	00	\$ 11.00	\$ 77.00
6-40 (.138) UNF	TPS100031	5/16	TPS100032	TPS100033	7/32		\$ 33.00	HDL000002	00	\$ 11.00	\$ 77.00
8-32 (.164) UNC	TPS100040	13/32	TPS100041	TPS100042	9/32		\$ 33.00	HDL000003	0	\$ 11.00	\$ 77.00
8-36 (.164) UNF	TPS100034	13/32	TPS100035	TPS100036	9/32		\$ 33.00	HDL000003	0	\$ 11.00	\$ 77.00
10-24 (.190) UNC	TPS100052	13/32	TPS100053	TPS100054	9/32		\$ 33.00	HDL000003	0	\$ 11.00	\$ 77.00
10-32 (.190) UNF	TPS100043	13/32	TPS100044	TPS100045	9/32		\$ 33.00	HDL000003	0	\$ 11.00	\$ 77.00
12-24 (.216) UNC	TPS100055	13/32	TPS100056	TPS100057	9/32		\$ 33.00	HDL000003	0	\$ 11.00	\$ 77.00
12-28 (.216) UNF	TPS100049	13/32	TPS100050	TPS100051	9/32		\$ 33.00	HDL000003	0	\$ 11.00	\$ 77.00
12-32 (.216) UNEF	TPS100046	13/32	TPS100047	TPS100048	9/32		\$ 46.00	HDL000003	0	\$ 11.00	\$ 103.00
1/4-20 UNC	TPS100076	1/2	TPS100077	TPS100078	5/16		\$ 30.00	HDL000004	1	\$ 10.00	\$ 70.00
1/4-28 UNF	TPS100067	1/2	TPS100068	TPS100069	5/16		\$ 30.00	HDL000004	1	\$ 10.00	\$ 70.00
1/4-32 UNEF	TPS100058	1/2	TPS100059	TPS100060	5/16		\$ 57.00	HDL000004	1	\$ 10.00	\$ 124.00
5/16-18 UNC	TPS100079	1/2	TPS100080	TPS100081	5/16		\$ 30.00	HDL000004	1	\$ 10.00	\$ 70.00
5/16-24 UNF	TPS100070	1/2	TPS100071	TPS100072	5/16		\$ 30.00	HDL000004	1	\$ 10.00	\$ 70.00
5/16-32 UNEF	TPS100061	1/2	TPS100062	TPS100063	5/16		\$ 57.00	HDL000004	1	\$ 10.00	\$ 124.00
3/8-16 UNC	TPS100082	3/4	TPS100083	TPS100084	3/8		\$ 30.00	HDL000009	2	\$ 10.00	\$ 70.00
3/8-24 UNF	TPS100073	3/4	TPS100074	TPS100075	3/8		\$ 30.00	HDL000009	2	\$ 10.00	\$ 70.00
3/8-32 UNEF	TPS100064	3/4	TPS100065	TPS100066	3/8		\$ 66.00	HDL000009	2	\$ 10.00	\$ 142.00
7/16-14 UNC	TPS100109	3/4	TPS100110	TPS100111	3/8		\$ 32.00	HDL000009	2	\$ 10.00	\$ 74.00
7/16-20 UNF	TPS100097	3/4	TPS100098	TPS100099	3/8		\$ 32.00	HDL000009	2	\$ 10.00	\$ 74.00
7/16-28 UNEF	TPS100085	3/4	TPS100086	TPS100087	3/8		\$ 66.00	HDL000009	2	\$ 10.00	\$ 142.00
1/2-13 UNC	TPS100112	3/4	TPS100113	TPS100114	3/8		\$ 33.00	HDL000009	2	\$ 10.00	\$ 76.00
1/2-20 UNF	TPS100100	3/4	TPS100101	TPS100102	3/8		\$ 33.00	HDL000009	2	\$ 10.00	\$ 76.00
1/2-28 UNEF	TPS100088	3/4	TPS100089	TPS100090	3/8		\$ 67.00	HDL000009	2	\$ 10.00	\$ 144.00
9/16-12 UNC	TPS100115	7/8	TPS100116	TPS100117	1/2		\$ 45.00	HDL000014	3	\$ 10.00	\$ 100.00
9/16-18 UNF	TPS100103	7/8	TPS100104	TPS100105	1/2		\$ 45.00	HDL000014	3	\$ 10.00	\$ 100.00
9/16-24 UNEF	TPS100091	7/8	TPS100092	TPS100093	1/2		\$ 76.00	HDL000014	3	\$ 10.00	\$ 162.00
5/8-11 UNC	TPS100118	7/8	TPS100119	TPS100120	1/2		\$ 46.00	HDL000014	3	\$ 10.00	\$ 102.00
5/8-18 UNF	TPS100106	7/8	TPS100107	TPS100108	1/2		\$ 46.00	HDL000014	3	\$ 10.00	\$ 102.00
5/8-24 UNEF	TPS100094	7/8	TPS100095	TPS100096	1/2		\$ 76.00	HDL000014	3	\$ 10.00	\$ 162.00
11/16-24 UNF	TPS100121	7/8	TPS100122	TPS100123	1/2		\$ 76.00	HDL000014	3	\$ 10.00	\$ 162.00
3/4-10 UNC	TPS100151	7/8	TPS100152	TPS100153	1/2		\$ 49.00	HDL000014	3	\$ 10.00	\$ 108.00
3/4-16 UNF	TPS100139	7/8	TPS100140	TPS100141	1/2		\$ 49.00	HDL000014	3	\$ 10.00	\$ 108.00
3/4-20 UNEF	TPS100124	7/8	TPS100125	TPS100126	1/2		\$ 77.00	HDL000014	3	\$ 10.00	\$ 164.00
13/16-20 UNEF	TPS100127	7/8	TPS100128	TPS100129	1/2		\$ 86.00	HDL000014	3	\$ 10.00	\$ 182.00
7/8-9 UNC	TPS100154	1	TPS100155	TPS100156	5/8		\$ 51.00	HDL000019	4	\$ 11.00	\$ 113.00
7/8-14 UNF	TPS100142	1	TPS100143	TPS100144	5/8		\$ 53.00	HDL000019	4	\$ 11.00	\$ 117.00
7/8-20 UNEF	TPS100130	1	TPS100131	TPS100132	5/8		\$ 86.00	HDL000019	4	\$ 11.00	\$ 183.00
15/16-20 UNEF	TPS100133	1	TPS100134	TPS100135	5/8		\$ 87.00	HDL000019	4	\$ 11.00	\$ 185.00
1-8 UNC	TPS100157	1	TPS100158	TPS100159	5/8		\$ 62.00	HDL000019	4	\$ 11.00	\$ 135.00
1-12 UNF	TPS100145	1	TPS100146	TPS100147	5/8		\$ 62.00	HDL000019	4	\$ 11.00	\$ 135.00
1-14 UNS	TPS100148	1	TPS100149	TPS100150	5/8		\$ 62.00	HDL000019	4	\$ 11.00	\$ 135.00
1-20 UNEF	TPS100136	1	TPS100137	TPS100138	5/8		\$ 100.00	HDL000019	4	\$ 11.00	\$ 211.00
1 1/16-12 UN	TPS100175	1	TPS100176	TPS100177	5/8		\$ 103.00	HDL000019	4	\$ 11.00	\$ 217.00
1 1/16-18 UNEF	TPS100160	1	TPS100161	TPS100162	5/8		\$ 103.00	HDL000019	4	\$ 11.00	\$ 217.00
1 1/8-7 UNC	TPS100190	1	TPS100191	TPS100192	5/8		\$ 77.00	HDL000019	4	\$ 11.00	\$ 165.00
1 1/8-12 UNF	TPS100178	1	TPS100179	TPS100180	5/8		\$ 77.00	HDL000019	4	\$ 11.00	\$ 165.00
1 1/8-18 UNEF	TPS100163	1	TPS100164	TPS100165	5/8		\$ 101.00	HDL000019	4	\$ 11.00	\$ 213.00
1 3/16-12 UN	TPS100181	1	TPS100182	TPS100183	3/4		\$ 109.00	HDL000024	5	\$ 12.00	\$ 230.00
1 3/16-18 UNEF	TPS100166	1	TPS100167	TPS100168	3/4		\$ 109.00	HDL000024	5	\$ 12.00	\$ 230.00
1 1/4-7 UNC	TPS100193	1 1/4	TPS100194	TPS100195	3/4		\$ 79.00	HDL000024	5	\$ 12.00	\$ 170.00
1 1/4-12 UNF	TPS100184	1	TPS100185	TPS100186	3/4		\$ 79.00	HDL000024	5	\$ 12.00	\$ 170.00
1 1/4-18 UNEF	TPS100169	1	TPS100170	TPS100171	3/4		\$ 104.00	HDL000024	5	\$ 12.00	\$ 220.00
1 5/16-12 UN	TPS100187	1	TPS100188	TPS100189	3/4		\$ 118.00	HDL000024	5	\$ 12.00	\$ 248.00
1 5/16-18 UNEF	TPS100172	1	TPS100173	TPS100174	3/4		\$ 118.00	HDL000024	5	\$ 12.00	\$ 248.00
1 3/8-6 UNC	TPS100232	1 1/4	TPS100233	TPS100234	3/4		\$ 90.00	HDL000024	5	\$ 12.00	\$ 192.00
1 3/8-12 UNF	TPS100205	1	TPS100206	TPS100207	3/4		\$ 90.00	HDL000024	5	\$ 12.00	\$ 192.00
1 3/8-18 UNEF	TPS100196	1	TPS100197	TPS100198	3/4		\$ 124.00	HDL000024	5	\$ 12.00	\$ 260.00
1 7/16-12 UN	TPS100208	1	TPS100209	TPS100210	3/4		\$ 128.00	HDL000024	5	\$ 12.00	\$ 268.00
1 7/16-18 UNEF	TPS100199	1	TPS100200	TPS100201	3/4		\$ 128.00	HDL000024	5	\$ 12.00	\$ 268.00
1 1/2-6 UNC	TPS100235	1 1/4	TPS100236	TPS100237	3/4		\$ 101.00	HDL000024	5	\$ 12.00	\$ 214.00
1 1/2-12 UNF	TPS100211	1	TPS100212	TPS100213	3/4		\$ 101.00	HDL000024	5	\$ 12.00	\$ 214.00
1 1/2-18 UNEF	TPS100202	1	TPS100203	TPS100204	3/4		\$ 134.00	HDL000024	5	\$ 12.00	\$ 280.00
1 5/8-12 UN	TPS100214	1 1/4	TPS100215	TPS100216	7/8		\$ 140.00	HDL000023	5.5	\$ 16.00	\$ 296.00
1 3/4-12 UN	TPS100217	1 1/4	TPS100218	TPS100219	7/8		\$ 147.00	HDL000023	5.5	\$ 16.00	\$ 310.00
1 7/8-12 UN	TPS100220	1 1/4	TPS100221	TPS100222	7/8		\$ 158.00	HDL000023	5.5	\$ 16.00	\$ 332.00
2-12 UN	TPS100223	1 1/4	TPS100224	TPS100225	7/8		\$ 166.00	HDL000023	6	\$ 16.00	\$ 348.00
2 1/4-12 UN	TPS100226	1 3/8	TPS100227	TPS100228	7/8		\$ 190.00	HDL000028	6	\$ 16.00	\$ 396.00
2 1/2-12 UN	TPS100229	1 3/8	TPS100230	TPS100231	7/8		\$ 214.00	HDL000028	6	\$ 16.00	\$ 444.00

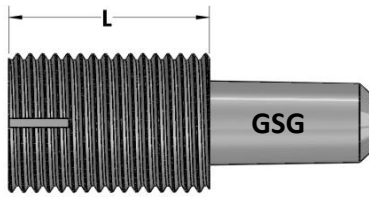

GO

**TAPERLOCK
THREAD WORK PLUG GAGES
CHROME**

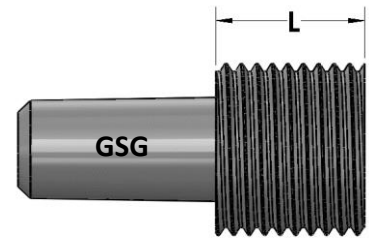

NO-GO

All GSG Thread Work Plug Gages are manufactured to ASME/ANSI B1.2 or B1.16M.
Taperlock style up to 1.5 inch / M36, above are trilock style.
Chip grooves are provided on all Go work plug members #10 / M4 and larger.
All gages are made of oil hardened tool steel and chrome plated.

METRIC

Nominal Size	Go Class 6H EDP #	Go Length "L"	NoGo Class 6H EDP #	NoGo Length "L"	Member Price	Handle EDP #	Handle #	Handle Price	Double End Go/NoGo/Hdle Price
M1.6 x 0.35	TPC200002	1/4	TPC200001	3/16	\$ 71.00	HDL000001	000	\$ 11.00	\$ 153.00
M1.8 x 0.35	TPC200004	1/4	TPC200003	3/16	\$ 71.00	HDL000001	000	\$ 11.00	\$ 153.00
M2.0 x 0.40	TPC200006	1/4	TPC200005	3/16	\$ 71.00	HDL000001	000	\$ 11.00	\$ 153.00
M2.2 x 0.45	TPC200008	1/4	TPC200007	3/16	\$ 71.00	HDL000001	000	\$ 11.00	\$ 153.00
M2.5 x 0.45	TPC200010	1/4	TPC200009	3/16	\$ 62.00	HDL000001	000	\$ 11.00	\$ 135.00
M3.0 x 0.50	TPC200012	5/16	TPC200011	7/32	\$ 62.00	HDL000002	00	\$ 11.00	\$ 135.00
M3.5 x 0.60	TPC200014	5/16	TPC200013	7/32	\$ 53.00	HDL000002	00	\$ 11.00	\$ 117.00
M4.0 x 0.70	TPC200016	13/32	TPC200015	9/32	\$ 53.00	HDL000003	0	\$ 11.00	\$ 117.00
M4.5 x 0.75	TPC200018	13/32	TPC200017	9/32	\$ 53.00	HDL000003	0	\$ 11.00	\$ 117.00
M5.0 x 0.80	TPC200020	13/32	TPC200019	9/32	\$ 53.00	HDL000003	0	\$ 11.00	\$ 117.00
M6.0 x 1.00	TPC200022	1/2	TPC200021	5/16	\$ 43.00	HDL000004	1	\$ 10.00	\$ 96.00
M7.0 x 1.00	TPC200024	1/2	TPC200023	5/16	\$ 43.00	HDL000004	1	\$ 10.00	\$ 96.00
M8.0 x 1.25	TPC200027	1/2	TPC200025	5/16	\$ 43.00	HDL000004	1	\$ 10.00	\$ 96.00
M8.0 x 1.00	TPC200026	1/2	TPC200028	5/16	\$ 43.00	HDL000004	1	\$ 10.00	\$ 96.00
M10.0 x 1.00	TPC200034	3/4	TPS200031	3/8	\$ 46.00	HDL000009	2	\$ 10.00	\$ 102.00
M10.0 x 1.50	TPC200032	3/4	TPC200029	3/8	\$ 46.00	HDL000009	2	\$ 10.00	\$ 102.00
M10.0 x 1.25	TPC200033	3/4	TPC200030	3/8	\$ 46.00	HDL000009	2	\$ 10.00	\$ 102.00
M12.0 x 1.75	TPC200039	3/4	TPC200035	3/8	\$ 50.00	HDL000009	2	\$ 10.00	\$ 110.00
M12.0 x 1.50	TPC200040	3/4	TPC200036	3/8	\$ 50.00	HDL000009	2	\$ 10.00	\$ 110.00
M12.0 x 1.25	TPC200041	3/4	TPC200037	3/8	\$ 52.00	HDL000009	2	\$ 10.00	\$ 114.00
M12.0 x 1.00	TPC200042	3/4	TPC200038	3/8	\$ 55.00	HDL000009	2	\$ 10.00	\$ 120.00
M14.0 x 2.00	TPC200046	7/8	TPC200043	1/2	\$ 55.00	HDL000014	3	\$ 10.00	\$ 120.00
M14.0 x 1.50	TPC200047	7/8	TPC200044	1/2	\$ 55.00	HDL000014	3	\$ 10.00	\$ 120.00
M14.0 x 1.00	TPC200045	7/8	TPC200048	1/2	\$ 82.00	HDL000014	3	\$ 10.00	\$ 174.00
M15.0 x 1.00	TPC200050	7/8	TPC200049	1/2	\$ 55.00	HDL000014	3	\$ 10.00	\$ 120.00
M16.0 x 2.00	TPC200053	7/8	TPC200051	1/2	\$ 55.00	HDL000014	3	\$ 10.00	\$ 120.00
M16.0 x 1.50	TPC200054	7/8	TPC200052	1/2	\$ 55.00	HDL000014	3	\$ 10.00	\$ 120.00
M17.0 x 1.00	TPC200056	7/8	TPC200055	1/2	\$ 58.00	HDL000014	3	\$ 10.00	\$ 126.00
M18.0 x 2.50	TPC200059	7/8	TPC200058	1/2	\$ 62.00	HDL000014	3	\$ 10.00	\$ 134.00
M18.0 x 1.50	TPC200060	7/8	TPC200057	1/2	\$ 62.00	HDL000014	3	\$ 10.00	\$ 134.00
M20.0 x 2.50	TPC200063	7/8	TPC200061	1/2	\$ 78.00	HDL000014	3	\$ 10.00	\$ 166.00
M20.0 x 1.50	TPC200064	7/8	TPC200062	1/2	\$ 72.00	HDL000014	3	\$ 10.00	\$ 154.00
M22.0 x 2.50	TPC200067	1	TPC200065	5/8	\$ 72.00	HDL000019	4	\$ 11.00	\$ 155.00
M22.0 x 1.50	TPC200068	1	TPC200066	5/8	\$ 72.00	HDL000019	4	\$ 11.00	\$ 155.00
M24.0 x 3.00	TPC200072	1	TPC200069	5/8	\$ 80.00	HDL000019	4	\$ 11.00	\$ 171.00
M24.0 x 2.00	TPC200071	1	TPC200070	5/8	\$ 80.00	HDL000019	4	\$ 11.00	\$ 171.00
M27.0 x 3.00	TPC200076	1	TPC200073	5/8	\$ 109.00	HDL000019	4	\$ 11.00	\$ 229.00
M27.0 x 2.00	TPC200075	1	TPC200074	5/8	\$ 109.00	HDL000019	4	\$ 11.00	\$ 229.00
M30.0 x 3.50	TPC200082	1 1/4	TPC200077	3/4	\$ 128.00	HDL000024	5	\$ 12.00	\$ 268.00
M30.0 x 2.00	TPC200080	1	TPC200078	3/4	\$ 128.00	HDL000024	5	\$ 12.00	\$ 268.00
M30.0 x 1.50	TPC200081	1	TPC200079	3/4	\$ 128.00	HDL000024	5	\$ 12.00	\$ 268.00
M33.0 x 3.50	TPC200086	1 1/4	TPC200083	3/4	\$ 128.00	HDL000024	5	\$ 12.00	\$ 268.00
M33.0 x 2.00	TPC200085	1	TPC200084	3/4	\$ 128.00	HDL000024	5	\$ 12.00	\$ 268.00
M35.0 x 1.50	TPC200090	1	TPC200088	3/4	\$ 137.00	HDL000024	5	\$ 12.00	\$ 286.00
M36.0 x 4.00	TPC200093	1 1/4	TPC200087	3/4	\$ 146.00	HDL000024	5	\$ 12.00	\$ 304.00
M36.0 x 3.00	TPC200094	1 1/4	TPC200089	3/4	\$ 146.00	HDL000024	5	\$ 12.00	\$ 304.00
M36.0 x 2.00	TPC200092	1	TPC200091	3/4	\$ 146.00	HDL000024	5	\$ 12.00	\$ 304.00
M39.0 x 4.00	TPC200099	1 7/8	TPC200095	7/8	\$ 162.00	HDL000023	5 1/2	\$ 16.00	\$ 340.00
M39.0 x 3.00	TPC200100	1 1/4	TPC200096	7/8	\$ 162.00	HDL000023	5 1/2	\$ 16.00	\$ 340.00
M39.0 X 2.00	TPC200098	1 1/4	TPC200097	7/8	\$ 162.00	HDL000023	5 1/2	\$ 16.00	\$ 340.00

**TAPERLOCK
THREAD PLUG GAGES
CHROME**

INCH											
Nominal Size	Go Basic 2B or 3B EDP #	Go Length "L"	NoGo Class 2B EDP #	NoGo Class 3B EDP #	NoGo Length "L"	Member Price	Handle EDP #	Handle #	Handle Price	Double End Go/NoGo/Hdle Price	
0-80 (.060) UNF	TPC100001	1/4	TPC100002	TPC100003	3/16	\$ 58.00	HDL000001	000	\$ 11.00	\$ 127.00	
1-64 (.073) UNC	TPC100238	1/4	TPC100239	TPC100240	3/16	\$ 58.00	HDL000001	000	\$ 11.00	\$ 127.00	
1-72 (.073) UNF	TPC100004	1/4	TPC100005	TPC100006	3/16	\$ 58.00	HDL000001	000	\$ 11.00	\$ 127.00	
2-56 (.086) UNC	TPC100010	1/4	TPC100011	TPC100012	3/16	\$ 55.00	HDL000001	000	\$ 11.00	\$ 121.00	
2-64 (.086) UNF	TPC100007	1/4	TPC100008	TPC100009	3/16	\$ 55.00	HDL000001	000	\$ 11.00	\$ 121.00	
3-48 (.099) UNC	TPC100016	1/4	TPC100017	tpc100018	3/16	\$ 53.00	HDL000001	000	\$ 11.00	\$ 117.00	
3-56 (.099) UNF	TPC100013	1/4	TPC100014	TPC100015	3/16	\$ 53.00	HDL000001	000	\$ 11.00	\$ 117.00	
4-40 (.112) UNC	TPC100025	5/16	TPC100026	TPC100027	7/32	\$ 49.00	HDL000002	00	\$ 11.00	\$ 109.00	
4-48 (.112) UNF	TPC100019	5/16	TPC100020	TPC100021	7/32	\$ 51.00	HDL000002	00	\$ 11.00	\$ 113.00	
5-40 (.125) UNC	TPC100028	5/16	TPC100029	TPC100030	7/32	\$ 43.00	HDL000002	00	\$ 11.00	\$ 97.00	
5-44 (.125) UNF	TPC100022	5/16	TPC100023	TPC100024	7/32	\$ 43.00	HDL000002	00	\$ 11.00	\$ 97.00	
6-32 (.138) UNC	TPC100037	5/16	TPC100038	TPC100039	7/32	\$ 42.00	HDL000002	00	\$ 11.00	\$ 95.00	
6-40 (.138) UNF	TPC100031	5/16	TPC100032	TPC100033	7/32	\$ 42.00	HDL000002	00	\$ 11.00	\$ 95.00	
8-32 (.164) UNC	TPC100040	13/32	TPC100041	TPC100042	9/32	\$ 42.00	HDL000003	0	\$ 11.00	\$ 95.00	
8-36 (.164) UNF	TPC100034	13/32	TPC100035	TPC100036	9/32	\$ 42.00	HDL000003	0	\$ 11.00	\$ 95.00	
10-24 (.190) UNC	TPC100052	13/32	TPC100053	TPC100054	9/32	\$ 42.00	HDL000003	0	\$ 11.00	\$ 95.00	
10-32 (.190) UNF	TPC100043	13/32	TPC100044	TPC100045	9/32	\$ 42.00	HDL000003	0	\$ 11.00	\$ 95.00	
12-24 (.216) UNC	TPC100055	13/32	TPC100056	TPC100057	9/32	\$ 42.00	HDL000003	0	\$ 11.00	\$ 95.00	
12-28 (.216) UNF	TPC100049	13/32	TPC100050	TPC100051	9/32	\$ 42.00	HDL000003	0	\$ 11.00	\$ 95.00	
12-32 (.216) UNEF	TPC100046	13/32	TPC100047	TPC100048	9/32	\$ 67.00	HDL000003	0	\$ 11.00	\$ 145.00	
1/4-20 UNC	TPC100076	1/2	TPC100077	TPC100078	5/16	\$ 38.00	HDL000004	1	\$ 10.00	\$ 86.00	
1/4-28 UNF	TPC100067	1/2	TPC100068	TPC100069	5/16	\$ 38.00	HDL000004	1	\$ 10.00	\$ 86.00	
1/4-32 UNEF	TPC100058	1/2	TPC100059	TPC100060	5/16	\$ 72.00	HDL000004	1	\$ 10.00	\$ 154.00	
5/16-18 UNC	TPC100079	1/2	TPC100080	TPC100081	5/16	\$ 38.00	HDL000004	1	\$ 10.00	\$ 86.00	
5/16-24 UNF	TPC100070	1/2	TPC100071	TPC100072	5/16	\$ 38.00	HDL000004	1	\$ 10.00	\$ 86.00	
5/16-32 UNEF	TPC100061	1/2	TPC100062	TPC100063	5/16	\$ 72.00	HDL000004	1	\$ 10.00	\$ 154.00	
3/8-16 UNC	TPC100082	3/4	TPC100083	TPC100084	3/8	\$ 37.00	HDL000009	2	\$ 10.00	\$ 84.00	
3/8-24 UNF	TPC100073	3/4	TPC100074	TPC100075	3/8	\$ 37.00	HDL000009	2	\$ 10.00	\$ 84.00	
3/8-32 UNEF	TPC100064	3/4	TPC100065	TPC100066	3/8	\$ 80.00	HDL000009	2	\$ 10.00	\$ 170.00	
7/16-14 UNC	TPC100109	3/4	TPC100110	TPC100111	3/8	\$ 40.00	HDL000009	2	\$ 10.00	\$ 90.00	
7/16-20 UNF	TPC100097	3/4	TPC100098	TPC100099	3/8	\$ 40.00	HDL000009	2	\$ 10.00	\$ 90.00	
7/16-28 UNEF	TPC100085	3/4	TPC100086	TPC100087	3/8	\$ 80.00	HDL000009	2	\$ 10.00	\$ 170.00	
1/2-13 UNC	TPC100112	3/4	TPC100113	TPC100114	3/8	\$ 42.00	HDL000009	2	\$ 10.00	\$ 94.00	
1/2-20 UNF	TPC100100	3/4	TPC100101	TPC100102	3/8	\$ 42.00	HDL000009	2	\$ 10.00	\$ 94.00	
1/2-28 UNEF	TPC100088	3/4	TPC100089	TPC100090	3/8	\$ 82.00	HDL000009	2	\$ 10.00	\$ 174.00	
9/16-12 UNC	TPC100115	7/8	TPC100116	TPC100117	1/2	\$ 51.00	HDL000014	3	\$ 10.00	\$ 112.00	
9/16-18 UNF	TPC100103	7/8	TPC100104	TPC100105	1/2	\$ 51.00	HDL000014	3	\$ 10.00	\$ 112.00	
9/16-24 UNEF	TPC100091	7/8	TPC100092	TPC100093	1/2	\$ 87.00	HDL000014	3	\$ 10.00	\$ 184.00	
5/8-11 UNC	TPC100118	7/8	TPC100119	TPC100120	1/2	\$ 53.00	HDL000014	3	\$ 10.00	\$ 116.00	
5/8-18 UNF	TPC100106	7/8	TPC100107	TPC100108	1/2	\$ 53.00	HDL000014	3	\$ 10.00	\$ 116.00	
5/8-24 UNEF	TPC100094	7/8	TPC100095	TPC100096	1/2	\$ 87.00	HDL000014	3	\$ 10.00	\$ 184.00	
11/16-24 UNF	TPC100121	7/8	TPC100122	TPC100123	1/2	\$ 90.00	HDL000014	3	\$ 10.00	\$ 190.00	
3/4-10 UNC	TPC100151	7/8	TPC100152	TPC100153	1/2	\$ 57.00	HDL000014	3	\$ 10.00	\$ 124.00	
3/4-16 UNF	TPC100139	7/8	TPC100140	TPC100141	1/2	\$ 57.00	HDL000014	3	\$ 10.00	\$ 124.00	
3/4-20 UNEF	TPC100124	7/8	TPC100125	TPC100126	1/2	\$ 93.00	HDL000014	3	\$ 10.00	\$ 196.00	
13/16-20 UNEF	TPC100127	7/8	TPC100128	TPC100129	1/2	\$ 105.00	HDL000014	3	\$ 10.00	\$ 220.00	
7/8-9 UNC	TPC100154	1	TPC100155	TPC100156	5/8	\$ 60.00	HDL000019	4	\$ 11.00	\$ 131.00	
7/8-14 UNF	TPC100142	1	TPC100143	TPC100144	5/8	\$ 63.00	HDL000019	4	\$ 11.00	\$ 137.00	
7/8-20 UNEF	TPC100130	1	TPC100131	TPC100132	5/8	\$ 105.00	HDL000019	4	\$ 11.00	\$ 221.00	
15/16-20 UNF	TPC100133	1	TPC100134	TPC100135	5/8	\$ 109.00	HDL000019	4	\$ 11.00	\$ 229.00	
1-8 UNC	TPC100157	1	TPC100158	TPC100159	5/8	\$ 77.00	HDL000019	4	\$ 11.00	\$ 165.00	
1-12 UNF	TPC100145	1	TPC100146	TPC100147	5/8	\$ 77.00	HDL000019	4	\$ 11.00	\$ 165.00	
1-14 UNS	TPC100148	1	TPC100149	TPC100150	5/8	\$ 77.00	HDL000019	4	\$ 11.00	\$ 165.00	
1-20 UNEF	TPC100136	1	TPC100137	TPC100138	5/8	\$ 120.00	HDL000019	4	\$ 11.00	\$ 251.00	
1 1/16-12 UN	TPC100175	1	TPC100176	TPC100177	5/8	\$ 124.00	HDL000019	4	\$ 11.00	\$ 259.00	
1 1/16-18 UNEF	TPC100160	1	TPC100161	TPC100162	5/8	\$ 124.00	HDL000019	4	\$ 11.00	\$ 259.00	
1 1/8- 7 UNC	TPC100190	1	TPC100191	TPC100192	5/8	\$ 93.00	HDL000019	4	\$ 11.00	\$ 197.00	
1 1/8-12 UNF	TPC100178	1	TPC100179	TPC100180	5/8	\$ 93.00	HDL000019	4	\$ 11.00	\$ 197.00	
1 1/8-18 UNEF	TPC100163	1	TPC100164	TPC100165	5/8	\$ 121.00	HDL000019	4	\$ 11.00	\$ 253.00	
1 3/16-12 UN	TPC100181	1	TPC100182	TPC100183	3/4	\$ 134.00	HDL000024	5	\$ 12.00	\$ 280.00	
1 3/16-18 UNEF	TPC100166	1	TPC100167	TPC100168	3/4	\$ 134.00	HDL000024	5	\$ 12.00	\$ 280.00	
1 1/4-7 UNC	TPC100193	1 1/4	TPC100194	TPC100195	3/4	\$ 97.00	HDL000024	5	\$ 12.00	\$ 206.00	
1 1/4-12 UNF	TPC100184	1	TPC100185	TPC100186	3/4	\$ 97.00	HDL000024	5	\$ 12.00	\$ 206.00	
1 1/4-18 UNEF	TPC100169	1	TPC100170	TPC100171	3/4	\$ 128.00	HDL000024	5	\$ 12.00	\$ 268.00	
1 5/16-12 UN	TPC100187	1	TPC100188	TPC100189	3/4	\$ 145.00	HDL000024	5	\$ 12.00	\$ 302.00	
1 5/16-18 UNEF	TPC100172	1	TPC100173	TPC100174	3/4	\$ 145.00	HDL000024	5	\$ 12.00	\$ 302.00	
1 3/8-6 UNC	TPC100232	1 1/4	TPC100233	TPC100234	3/4	\$ 110.00	HDL000024	5	\$ 12.00	\$ 232.00	
1 3/8-12 UNF	TPC100205	1	TPC100206	TPC100207	3/4	\$ 110.00	HDL000024	5	\$ 12.00	\$ 232.00	
1 3/8-18 UNEF	TPC100196	1	TPC100197	TPC100198	3/4	\$ 148.00	HDL000024	5	\$ 12.00	\$ 308.00	
1 7/16-12 UN	TPC100208	1	TPC100209	TPC100210	3/4	\$ 155.00	HDL000024	5	\$ 12.00	\$ 322.00	
1 7/16-18 UNEF	TPC100199	1	TPC100200	TPC100201	3/4	\$ 155.00	HDL000024	5	\$ 12.00	\$ 322.00	
1 1/2-6 UNC	TPC100235	1 1/4	TPC100236	TPC100237	3/4	\$ 121.00	HDL000024	5	\$ 12.00	\$ 254.00	
1 1/2-12 UNF	TPC100211	1	TPC100212	TPC100213	3/4	\$ 121.00	HDL000024	5	\$ 12.00	\$ 254.00	
1 1/2-18 UNEF	TPC100202	1	TPC100203	TPC100204	3/4	\$ 160.00	HDL000024	5	\$ 12.00	\$ 332.00	
1 5/8-12 UN	TPC100214	1 1/4	TPC100215	TPC100216	7/8	\$ 173.00	HDL000023	5.5	\$ 16.00	\$ 362.00	
1 3/4-12 UN	TPC100217	1 1/4	TPC100218	TPC100219	7/8	\$ 177.00	HDL000023	5.5	\$ 16.00	\$ 370.00	
1 7/8-12 UN	TPC100220	1 1/4	TPC100221	TPC100222	7/8	\$ 192.00	HDL000023	5.5	\$ 16.00	\$ 400.00	
2-12 UN	TPC100223	1 1/4	TPC100224	TPC100225	7/8	\$ 202.00	HDL000028	6	\$ 16.00	\$ 420.00	
2 1/4-12 UN	TPC100226	1 3/8	TPC100227	TPC100228	7/8	\$ 230.00	HDL000028	6	\$ 16.00	\$ 476.00	
2 1/2-12 UN	TPC100229	1 3/8	TPC100230	TPC100231	7/8	\$ 261.00	HDL000028	6	\$ 16.00	\$ 538.00	

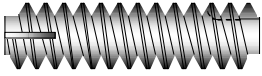

**REVERSIBLE
THREAD WORK PLUG GAGES
STEEL**

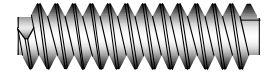

All GSG Thread Work Plug Gages are manufactured to ASME/ANSI B1.2 or B1.16M.
Chip grooves are provided on both ends of the GO work plug members #10 / M4
and larger. All gages are made of oil hardened tool steel.

METRIC								
Nominal Size	Go Class 6H EDP #	NoGo Class 6H EDP #	Length MM	Member Price	Handle Double End EDP #	Handle #	Handle Price	Double End Go/NoGo/Hdle Price
M1.6 x 0.35	TPS200102	TPS200101	12.7	\$ 73.00	HDL000005	1 WDE	\$ 12.00	\$ 158.00
M2.0 x 0.40	TPS200104	TPS200103	15.9	\$ 73.00	HDL000010	2 WDE	\$ 12.00	\$ 158.00
M2.5 x 0.45	TPS200106	TPS200105	15.9	\$ 73.00	HDL000010	2 WDE	\$ 12.00	\$ 158.00
M3.0 x 0.50	TPS200108	TPS200107	15.9	\$ 67.00	HDL000010	2 WDE	\$ 12.00	\$ 146.00
M3.5 x 0.60	TPS200110	TPS200109	19	\$ 58.00	HDL000010	2 WDE	\$ 12.00	\$ 128.00
M4.0 x 0.70	TPS200112	TPS200111	19	\$ 58.00	HDL000010	2 WDE	\$ 12.00	\$ 128.00
M5.0 x 0.80	TPS200114	TPS200113	22.2	\$ 58.00	HDL000015	3 WDE	\$ 13.00	\$ 129.00
M6.0 x 1.00	TPS200116	TPS200115	22.2	\$ 49.00	HDL000015	3 WDE	\$ 13.00	\$ 111.00
M8.0 x 1.25	TPS200118	TPS200117	25.4	\$ 49.00	HDL000020	4 WDE	\$ 14.00	\$ 112.00
M8.0 x 1.00	TPS200142	TPS200141	25.4	\$ 49.00	HDL000020	4 WDE	\$ 14.00	\$ 112.00
M10.0 x 1.50	TPS200121	TPS200119	28.6	\$ 51.00	HDL000020	4 WDE	\$ 14.00	\$ 116.00
M10.0 x 1.25	TPS200122	TPS200120	28.6	\$ 51.00	HDL000020	4 WDE	\$ 14.00	\$ 116.00
M12.0 x 1.75	TPS200127	TPS200123	34.9	\$ 55.00	HDL000025	5 WDE	\$ 14.00	\$ 124.00
M12.0 x 1.50	TPS200128	TPS200124	34.9	\$ 55.00	HDL000025	5 WDE	\$ 14.00	\$ 124.00
M12.0 x 1.25	TPS200129	TPS200125	34.9	\$ 55.00	HDL000025	5 WDE	\$ 14.00	\$ 124.00
M12.0 x 1.00	TPS200130	TPS200126	34.9	\$ 55.00	HDL000025	5 WDE	\$ 14.00	\$ 124.00
M14.0 x 2.00	TPS200133	TPS200131	38.1	\$ 63.00	HDL000029	6 WDE	\$ 15.00	\$ 141.00
M14.0 x 1.50	TPS200134	TPS200132	38.1	\$ 63.00	HDL000029	6 WDE	\$ 15.00	\$ 141.00
M16.0 x 2.00	TPS200137	TPS200135	38.1	\$ 66.00	HDL000029	6 WDE	\$ 15.00	\$ 147.00
M16.0 x 1.50	TPS200138	TPS200136	38.1	\$ 66.00	HDL000029	6 WDE	\$ 15.00	\$ 147.00
M18.0 x 1.50	TPS200140	TPS200139	44.4	\$ 67.00	HDL000029	6 WDE	\$ 15.00	\$ 149.00

INCH									
Nominal Size	Go Basic 2B or 3B EDP #	NoGo Class 2B EDP #	NoGo Class 3B EDP #	Length Inch	Member Price	Handle Double End EDP #	Handle #	Handle Price	Double End Go/NoGo/Hdle Price
0-80 (.060) UNF	TPS100900	TPS100276	TPS100275	1/2	\$ 66.00	HDL000005	1 WDE	\$ 12.00	\$ 144.00
1-64 (.073) UNC	TPS100910	TPS100911	TPS100912	1/2	\$ 66.00	HDL000005	1 WDE	\$ 12.00	\$ 144.00
1-72 (.073) UNF	TPS100901	TPS100278	TPS100277	1/2	\$ 66.00	HDL000005	1 WDE	\$ 12.00	\$ 144.00
2-56 (.086) UNC	TPS100903	TPS100281	TPS100279	5/8	\$ 66.00	HDL000010	2 WDE	\$ 12.00	\$ 144.00
3-48 (.099) UNC	TPS100905	TPS100285	TPS100283	5/8	\$ 62.00	HDL000010	2 WDE	\$ 12.00	\$ 136.00
3-56 (.099) UNF	TPS100904	TPS100286	TPS100284	5/8	\$ 62.00	HDL000010	2 WDE	\$ 12.00	\$ 136.00
4-40 (.112) UNC	TPS100907	TPS100289	TPS100287	5/8	\$ 58.00	HDL000010	2 WDE	\$ 12.00	\$ 128.00
4-48 (.112) UNF	TPS100906	TPS100290	TPS100288	5/8	\$ 58.00	HDL000010	2 WDE	\$ 12.00	\$ 128.00
5-40 (.125) UNC	TPS100909	TPS100293	TPS100291	5/8	\$ 52.00	HDL000010	2 WDE	\$ 12.00	\$ 116.00
6-32 (.138) UNC	TPS100242	TPS100296	TPS100295	3/4	\$ 52.00	HDL000010	2 WDE	\$ 12.00	\$ 116.00
6-40 (.138) UNF	TPS100241	TPS100298	TPS100297	3/4	\$ 52.00	HDL000010	2 WDE	\$ 12.00	\$ 116.00
8-32 (.164) UNC	TPS100244	TPS100301	TPS100299	3/4	\$ 52.00	HDL000010	2 WDE	\$ 12.00	\$ 116.00
8-36 (.164) UNF	TPS100243	TPS100302	TPS100300	3/4	\$ 52.00	HDL000010	2 WDE	\$ 12.00	\$ 116.00
10-24 (.190) UNC	TPS100246	TPS100304	TPS100303	3/4	\$ 52.00	HDL000015	3 WDE	\$ 13.00	\$ 117.00
10-32 (.190) UNF	TPS100245	TPS100306	TPS100305	3/4	\$ 52.00	HDL000015	3 WDE	\$ 13.00	\$ 117.00
12-24 (.216) UNC	TPS100249	TPS100308	TPS100307	7/8	\$ 52.00	HDL000015	3 WDE	\$ 13.00	\$ 117.00
12-28 (.216) UNF	TPS100248	TPS100311	TPS100309	7/8	\$ 52.00	HDL000015	3 WDE	\$ 13.00	\$ 117.00
1/4-20 UNC	TPS100252	TPS100314	TPS100313	7/8	\$ 49.00	HDL000015	3 WDE	\$ 13.00	\$ 111.00
1/4-28 UNF	TPS100251	TPS100317	TPS100315	7/8	\$ 49.00	HDL000015	3 WDE	\$ 13.00	\$ 111.00
5/16-18 UNC	TPS100255	TPS100320	TPS100319	1	\$ 49.00	HDL000020	4 WDE	\$ 14.00	\$ 112.00
5/16-24 UNF	TPS100254	TPS100322	TPS100321	1	\$ 49.00	HDL000020	4 WDE	\$ 14.00	\$ 112.00
3/8-16 UNC	TPS100258	TPS100326	TPS100325	1 1/8	\$ 52.00	HDL000020	4 WDE	\$ 14.00	\$ 118.00
3/8-24 UNF	TPS100257	TPS100328	TPS100327	1 1/8	\$ 52.00	HDL000020	4 WDE	\$ 14.00	\$ 118.00
7/16-14 UNC	TPS100261	TPS100332	TPS100331	1 1/4	\$ 52.00	HDL000025	5 WDE	\$ 14.00	\$ 118.00
7/16-20 UNF	TPS100260	TPS100334	TPS100333	1 1/4	\$ 52.00	HDL000025	5 WDE	\$ 14.00	\$ 118.00
1/2-13 UNC	TPS100264	TPS100338	TPS100337	1 3/8	\$ 52.00	HDL000025	5 WDE	\$ 14.00	\$ 118.00
1/2-20 UNF	TPS100263	TPS100339	TPS100340	1 3/8	\$ 52.00	HDL000025	5 WDE	\$ 14.00	\$ 118.00
9/16-18 UNF	TPS100345	TPS100266	TPS100346	1 1/2	\$ 52.00	HDL000029	6 WDE	\$ 15.00	\$ 119.00
5/8-11 UNC	TPS100270	TPS100350	TPS100349	1 1/2	\$ 52.00	HDL000029	6 WDE	\$ 15.00	\$ 119.00
5/8-18 UNF	TPS100269	TPS100352	TPS100351	1 1/2	\$ 52.00	HDL000029	6 WDE	\$ 15.00	\$ 119.00
3/4-10 UNC	TPS100274	TPS100358	TPS100357	1 3/4	\$ 67.00	HDL000033	7 WDE	\$ 15.00	\$ 149.00
3/4-16 UNF	TPS100273	TPS100360	TPS100359	1 3/4	\$ 67.00	HDL000033	7 WDE	\$ 15.00	\$ 149.00

UNEF available, contact factory.

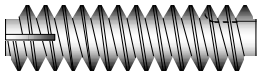

**REVERSIBLE
THREAD WORK PLUG GAGES
CHROME**

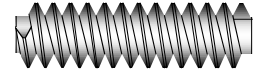

All GSG Thread Work Plug Gages are manufactured to ASME/ANSI B1.2 or B1.16M.
Chip grooves are provided on both ends of the Go work plug members #10 / M4
and larger. All gages are made of oil hardened tool steel and chrome plated.

METRIC								
Nominal Size	Go Class 6H EDP #	NoGo Class 6H EDP #	Length MM	Member Price	Handle Double End EDP #	Handle #	Handle Price	Double End Go/NoGo/Hdle Price
M1.6 x 0.35	TPC200102	TPC200101	12.7	\$ 92.00	HDL000005	1 WDE	\$ 12.00	\$ 196.00
M2.0 x 0.40	TPC200104	TPC200103	15.9	\$ 92.00	HDL000010	2 WDE	\$ 12.00	\$ 196.00
M2.5 x 0.45	TPC200106	TPC200105	15.9	\$ 92.00	HDL000010	2 WDE	\$ 12.00	\$ 196.00
M3.0 x 0.50	TPC200108	TPC200107	15.9	\$ 85.00	HDL000010	2 WDE	\$ 12.00	\$ 182.00
M3.5 x 0.60	TPC200110	TPC200109	19	\$ 72.00	HDL000010	2 WDE	\$ 12.00	\$ 156.00
M4.0 x 0.70	TPC200112	TPC200111	19	\$ 72.00	HDL000010	2 WDE	\$ 12.00	\$ 156.00
M5.0 x 0.80	TPC200114	TPC200113	22.2	\$ 72.00	HDL000015	3 WDE	\$ 13.00	\$ 157.00
M6.0 x 1.00	TPC200116	TPC200115	22.2	\$ 60.00	HDL000015	3 WDE	\$ 13.00	\$ 133.00
M8.0 x 1.25	TPC200118	TPC200117	25.4	\$ 60.00	HDL000020	4 WDE	\$ 14.00	\$ 134.00
M8.0 x 1.00	TPC200142	TPC200141	25.4	\$ 60.00	HDL000020	4 WDE	\$ 14.00	\$ 134.00
M10.0 x 1.50	TPC200121	TPC200119	28.6	\$ 63.00	HDL000020	4 WDE	\$ 14.00	\$ 140.00
M10.0 x 1.25	TPC200122	TPC200120	28.6	\$ 63.00	HDL000020	4 WDE	\$ 14.00	\$ 140.00
M12.0 x 1.75	TPC200127	TPC200123	34.9	\$ 67.00	HDL000025	5 WDE	\$ 14.00	\$ 148.00
M12.0 x 1.50	TPC200128	TPC200124	34.9	\$ 67.00	HDL000025	5 WDE	\$ 14.00	\$ 148.00
M12.0 x 1.25	TPC200129	TPC200125	34.9	\$ 67.00	HDL000025	5 WDE	\$ 14.00	\$ 148.00
M12.0 x 1.00	TPC200130	TPC200126	34.9	\$ 67.00	HDL000025	5 WDE	\$ 14.00	\$ 148.00
M14.0 x 2.00	TPC200133	TPC200131	38.1	\$ 77.00	HDL000029	6 WDE	\$ 15.00	\$ 169.00
M14.0 x 1.50	TPC200134	TPC200132	38.1	\$ 77.00	HDL000029	6 WDE	\$ 15.00	\$ 169.00
M16.0 x 2.00	TPC200137	TPC200135	38.1	\$ 82.00	HDL000029	6 WDE	\$ 15.00	\$ 179.00
M16.0 x 1.50	TPC200138	TPC200136	38.1	\$ 82.00	HDL000029	6 WDE	\$ 15.00	\$ 179.00
M18.0 x 1.50	TPC200140	TPC200139	44.4	\$ 87.00	HDL000029	6 WDE	\$ 15.00	\$ 189.00

INCH									
Nominal Size	Go BASIC 2B or 3B EDP #	NoGo Class 2B EDP #	NoGo Class 3B EDP #	Length Inch	Member Price	Handle Double End EDP #	Handle #	Handle Price	Double End Go/NoGo/Hdle Price
0-80 (.060) UNF	TPC100900	TPC100276	TPC100275	1/2	\$ 84.00	HDL000005	1 WDE	\$ 12.00	\$ 180.00
1-64 (.073) UNC	TPC100910	TPC100911	TPC100912	1/2	\$ 84.00	HDL000005	1 WDE	\$ 12.00	\$ 180.00
1-72 (.073) UNF	TPC100901	TPC100278	TPC100277	1/2	\$ 84.00	HDL000005	1 WDE	\$ 12.00	\$ 180.00
2-56 (.086) UNC	TPC100903	TPC100281	TPC100279	5/8	\$ 84.00	HDL000010	2 WDE	\$ 12.00	\$ 180.00
3-48 (.099) UNC	TPC100905	TPC100285	TPC100283	5/8	\$ 76.00	HDL000010	2 WDE	\$ 12.00	\$ 164.00
3-56 (.099) UNF	TPC100904	TPC100286	TPC100284	5/8	\$ 76.00	HDL000010	2 WDE	\$ 12.00	\$ 164.00
4-40 (.112) UNC	TPC100907	TPC100289	TPC100287	5/8	\$ 73.00	HDL000010	2 WDE	\$ 12.00	\$ 158.00
4-48 (.112) UNF	TPC100906	TPC100290	TPC100288	5/8	\$ 73.00	HDL000010	2 WDE	\$ 12.00	\$ 158.00
5-40 (.125) UNC	TPC100909	TPC100293	TPC100291	5/8	\$ 66.00	HDL000010	2 WDE	\$ 12.00	\$ 144.00
6-32 (.138) UNC	TPC100242	TPC100296	TPC100295	3/4	\$ 66.00	HDL000010	2 WDE	\$ 12.00	\$ 144.00
6-40 (.138) UNF	TPC100241	TPC100298	TPC100297	3/4	\$ 66.00	HDL000010	2 WDE	\$ 12.00	\$ 144.00
8-32 (.164) UNC	TPC100244	TPC100301	TPC100299	3/4	\$ 66.00	HDL000010	2 WDE	\$ 12.00	\$ 144.00
8-36 (.164) UNF	TPC100243	TPC100302	TPC100300	3/4	\$ 66.00	HDL000010	2 WDE	\$ 12.00	\$ 144.00
10-24 (.190) UNC	TPC100246	TPC100304	TPC100303	3/4	\$ 66.00	HDL000015	3 WDE	\$ 13.00	\$ 145.00
10-32 (.190) UNF	TPC100245	TPC100306	TPC100305	3/4	\$ 66.00	HDL000015	3 WDE	\$ 13.00	\$ 145.00
12-24 (.216) UNC	TPC100249	TPC100308	TPC100307	7/8	\$ 66.00	HDL000015	3 WDE	\$ 13.00	\$ 145.00
12-28 (.216) UNF	TPC100248	TPC100311	TPC100309	7/8	\$ 66.00	HDL000015	3 WDE	\$ 13.00	\$ 145.00
1/4-20 UNC	TPC100252	TPC100314	TPC100313	7/8	\$ 60.00	HDL000015	3 WDE	\$ 13.00	\$ 133.00
1/4-28 UNF	TPC100251	TPC100317	TPC100315	7/8	\$ 60.00	HDL000015	3 WDE	\$ 13.00	\$ 133.00
5/16-18 UNC	TPC100255	TPC100320	TPC100319	1	\$ 60.00	HDL000020	4 WDE	\$ 14.00	\$ 134.00
5/16-24 UNF	TPC100254	TPC100322	TPC100321	1	\$ 60.00	HDL000020	4 WDE	\$ 14.00	\$ 134.00
3/8-16 UNC	TPC100258	TPC100326	TPC100325	1 1/8	\$ 66.00	HDL000020	4 WDE	\$ 14.00	\$ 146.00
3/8-24 UNF	TPC100257	TPC100328	TPC100327	1 1/8	\$ 66.00	HDL000020	4 WDE	\$ 14.00	\$ 146.00
7/16-14 UNC	TPC100261	TPC100332	TPC100331	1 1/4	\$ 66.00	HDL000025	5 WDE	\$ 14.00	\$ 146.00
7/16-20 UNF	TPC100260	TPC100334	TPC100333	1 1/4	\$ 66.00	HDL000025	5 WDE	\$ 14.00	\$ 146.00
1/2-13 UNC	TPC100264	TPC100338	TPC100337	1 3/8	\$ 70.00	HDL000025	5 WDE	\$ 14.00	\$ 154.00
1/2-20 UNF	TPC100263	TPC100340	TPC100339	1 3/8	\$ 70.00	HDL000025	5 WDE	\$ 14.00	\$ 154.00
9/16-18 UNF	TPC100266	TPC100346	TPC100345	1 1/2	\$ 80.00	HDL000029	6 WDE	\$ 15.00	\$ 175.00
5/8-11 UNC	TPC100270	TPC100350	TPC100349	1 1/2	\$ 80.00	HDL000029	6 WDE	\$ 15.00	\$ 175.00
5/8-18 UNF	TPC100269	TPC100352	TPC100351	1 1/2	\$ 80.00	HDL000029	6 WDE	\$ 15.00	\$ 175.00
3/4-10 UNC	TPC100274	TPC100358	TPC100357	1 3/4	\$ 90.00	HDL000033	7 WDE	\$ 15.00	\$ 195.00
3/4-16 UNF	TPC100273	TPC100360	TPC100359	1 3/4	\$ 90.00	HDL000033	7 WDE	\$ 15.00	\$ 195.00

UNEF available, contact factory.

**TRUE ROUND
(FORMERLY SOUTHERN STYLE)
THREAD RING GAGES**



The True Round Adjustable Thread Ring Gage features an adjustment mechanism that maintains the roundness integrity of the gage throughout its use. Aluminum gage bodies anodized green for Go and red for NoGo provide quick positive identification. Inserts are made of oil hardened tool steel. Class and tolerances conform to ASME/ANSI B1.2 or B1.16M. Sizes below 1/4 / M6 are counterbored to hold specified length.

METRIC							
Nominal Size	Go Class 6g EDP #	Go Length "L"	NoGo Class 6g EDP #	NoGo Length "L"	STEEL Price	Holder EDP #	Holder Price
M1.6 x 0.35	TR2000100	3/32	TR2000101	3/32	\$ 198.00	HDL000037	\$ 21.00
M1.8 x 0.35	TR2000102	3/32	TR2000103	3/32	\$ 198.00	HDL000037	\$ 21.00
M2.0 x 0.40	TR2000104	3/32	TR2000105	3/32	\$ 183.00	HDL000037	\$ 21.00
M2.2 x 0.45	TR2000106	5/32	TR2000107	5/32	\$ 183.00	HDL000037	\$ 21.00
M2.5 x 0.45	TR2000108	5/32	TR2000109	5/32	\$ 183.00	HDL000037	\$ 21.00
M3.0 x 0.50	TR2000110	5/32	TR2000111	5/32	\$ 159.00	HDL000037	\$ 21.00
M3.5 x 0.60	TR2000112	5/32	TR2000113	5/32	\$ 159.00	HDL000037	\$ 21.00
M4.0 x 0.70	TR2000114	3/16	TR2000115	3/16	\$ 145.00	HDL000037	\$ 21.00
M4.5 x 0.75	TR2000116	3/16	TR2000117	3/16	\$ 145.00	HDL000037	\$ 21.00
M5.0 x 0.80	TR2000118	3/16	TR2000119	3/16	\$ 145.00	HDL000037	\$ 21.00
M6.0 x 1.00	TR2000128	11/32	TR2000129	11/32	\$ 136.00	HDL000038	\$ 22.00
M7.0 x 1.00	TR2000130	11/32	TR2000131	11/32	\$ 136.00	HDL000038	\$ 22.00
M8.0 x 1.25	TR2000138	11/32	TR2000139	11/32	\$ 136.00	HDL000038	\$ 22.00
M8.0 x 1.00	TR2000132	11/32	TR2000133	11/32	\$ 136.00	HDL000038	\$ 22.00
M10.0 x 1.50	TR2000140	7/16	TR2000141	7/16	\$ 145.00	HDL000039	\$ 23.00
M10.0 x 1.25	TR2000134	7/16	TR2000135	7/16	\$ 145.00	HDL000039	\$ 23.00
M12.0 x 1.75	TR2000158	7/16	TR2000159	7/16	\$ 153.00	HDL000039	\$ 23.00
M12.0 x 1.50	TR2000142	7/16	TR2000143	7/16	\$ 153.00	HDL000039	\$ 23.00
M12.0 x 1.25	TR2000136	7/16	TR2000137	7/16	\$ 150.00	HDL000039	\$ 23.00
M12.0 x 1.00	TR2000120	7/16	TR2000121	7/16	\$ 150.00	HDL000039	\$ 23.00
M14.0 x 2.00	TR2000160	9/16	TR2000161	9/16	\$ 178.00	HDL000040	\$ 26.00
M14.0 x 1.50	TR2000144	9/16	TR2000145	9/16	\$ 178.00	HDL000040	\$ 26.00
M14.0 x 1.00	TR2000122	9/16	TR2000123	9/16	\$ 178.00	HDL000040	\$ 26.00
M15.0 x 1.00	TR2000124	9/16	TR2000125	9/16	\$ 178.00	HDL000040	\$ 26.00
M16.0 x 2.00	TR2000162	9/16	TR2000163	9/16	\$ 178.00	HDL000040	\$ 26.00
M16.0 x 1.50	TR2000146	9/16	TR2000147	9/16	\$ 178.00	HDL000040	\$ 26.00
M17.0 x 1.00	TR2000126	9/16	TR2000127	9/16	\$ 232.00	HDL000040	\$ 26.00
M18.0 x 2.50	TR2000176	3/4	TR2000177	9/16	\$ 235.00	HDL000040	\$ 26.00
M18.0 x 1.50	TR2000148	9/16	TR2000149	9/16	\$ 235.00	HDL000040	\$ 26.00
M20.0 x 2.50	TR2000178	3/4	TR2000179	9/16	\$ 288.00	HDL000040	\$ 26.00
M20.0 x 1.50	TR2000150	9/16	TR2000153	9/16	\$ 288.00	HDL000040	\$ 26.00
M22.0 x 2.50	TR2000180	15/16	TR2000181	11/16	\$ 298.00	HDL000041	\$ 35.00
M22.0 x 1.50	TR2000152	11/16	TR2000151	11/16	\$ 298.00	HDL000041	\$ 35.00
M24.0 x 3.00	TR2000182	15/16	TR2000183	11/16	\$ 343.00	HDL000041	\$ 35.00
M24.0 x 2.00	TR2000164	11/16	TR2000165	11/16	\$ 343.00	HDL000041	\$ 35.00
M27.0 x 3.00	TR2000184	15/16	TR2000185	11/16	\$ 355.00	HDL000042	\$ 45.00
M27.0 x 2.00	TR2000166	11/16	TR2000167	11/16	\$ 355.00	HDL000042	\$ 45.00
M30.0 x 3.50	TR2000190	1 1/8	TR2000191	3/4	\$ 362.00	HDL000042	\$ 45.00
M30.0 x 2.00	TR2000168	3/4	TR2000169	3/4	\$ 362.00	HDL000042	\$ 45.00
M30.0 x 1.50	TR2000154	3/4	TR2000155	3/4	\$ 362.00	HDL000042	\$ 45.00
M33.0 x 3.50	TR2000192	1 1/8	TR2000193	3/4	\$ 400.00	HDL000042	\$ 45.00
M33.0 x 2.00	TR2000170	3/4	TR2000171	3/4	\$ 400.00	HDL000042	\$ 45.00
M35.0 x 1.50	TR2000156	3/4	TR2000157	3/4	\$ 425.00	HDL000042	\$ 45.00
M36.0 x 4.00	TR2000194	1 1/8	TR2000195	3/4	\$ 450.00	HDL000042	\$ 45.00
M36.0 x 3.00	TR2000186	1 1/8	TR2000187	3/4	\$ 450.00	HDL000042	\$ 45.00
M36.0 x 2.00	TR2000172	3/4	TR2000173	3/4	\$ 450.00	HDL000042	\$ 45.00
M39.0 x 4.00	TR2000196	1 1/4	TR2000197	13/16	\$ 454.00	NA	NA
M39.0 x 3.00	TR2000188	1 1/4	TR2000189	13/16	\$ 454.00	NA	NA
M39.0 x 2.00	TR2000174	13/16	TR2000175	13/16	\$ 454.00	NA	NA

**TRUE ROUND
(FORMERLY SOUTHERN STYLE)
THREAD RING GAGES**

INCH

Nominal Size	Go Class 2A EDP #	Go Class 3A EDP #	Go Length "L"	NoGo Class 2A EDP #	NoGo Class 3A EDP #	NoGo Length "L"	STEEL Price	Holder EDP #	Holder Price
0-80 (.060) UNF	TR1000400	TR1000402	3/32	TR1000401	TR1000403	3/32	\$ 178.00	HDL000037	\$ 21.00
1-64 (.073) UNC	TR1000404	TR1000406	3/32	TR1000405	TR1000407	3/32	\$ 161.00	HDL000037	\$ 21.00
1-72 (.073) UNF	TR1000408	TR1000410	3/32	TR1000409	TR1000411	3/32	\$ 161.00	HDL000037	\$ 21.00
2-56 (.086) UNC	TR1000412	TR1000414	3/32	TR1000413	TR1000415	3/32	\$ 158.00	HDL000037	\$ 21.00
2-64 (.086) UNF	TR1000416	TR1000418	3/32	TR1000417	TR1000419	3/32	\$ 158.00	HDL000037	\$ 21.00
3-48 (.099) UNC	TR1000420	TR1000422	5/32	TR1000421	TR1000423	5/32	\$ 158.00	HDL000037	\$ 21.00
3-56 (.099) UNF	TR1000424	TR1000426	5/32	TR1000425	TR1000427	5/32	\$ 145.00	HDL000037	\$ 21.00
4-40 (.112) UNC	TR1000428	TR1000430	5/32	TR1000429	TR1000431	5/32	\$ 145.00	HDL000037	\$ 21.00
4-48 (.112) UNF	TR1000432	TR1000434	5/32	TR1000433	TR1000435	5/32	\$ 145.00	HDL000037	\$ 21.00
5-40 (.125) UNC	TR1000436	TR1000438	5/32	TR1000437	TR1000439	5/32	\$ 130.00	HDL000037	\$ 21.00
5-44 (.125) UNF	TR1000440	TR1000442	5/32	TR1000441	TR1000443	5/32	\$ 130.00	HDL000037	\$ 21.00
6-32 (.138) UNC	TR1000444	TR1000446	5/32	TR1000445	TR1000447	5/32	\$ 130.00	HDL000037	\$ 21.00
6-40 (.138) UNF	TR1000448	TR1000450	5/32	TR1000449	TR1000451	5/32	\$ 130.00	HDL000037	\$ 21.00
8-32 (.164) UNC	TR1000452	TR1000454	3/16	TR1000453	TR1000455	3/16	\$ 124.00	HDL000037	\$ 21.00
8-36 (.164) UNF	TR1000456	TR1000458	3/16	TR1000457	TR1000459	3/16	\$ 124.00	HDL000037	\$ 21.00
10-24 (.190) UNC	TR1000460	TR1000462	3/16	TR1000461	TR1000463	3/16	\$ 124.00	HDL000037	\$ 21.00
10-32 (.190) UNF	TR1000464	TR1000466	3/16	TR1000465	TR1000467	3/16	\$ 124.00	HDL000037	\$ 21.00
12-24 (.216) UNC	TR1000468	TR1000470	3/16	TR1000469	TR1000471	3/16	\$ 124.00	HDL000037	\$ 21.00
12-28 (.216) UNF	TR1000472	TR1000474	3/16	TR1000473	TR1000475	3/16	\$ 124.00	HDL000037	\$ 21.00
1/4-20 UNC	TR1000476	TR1000478	11/32	TR1000477	TR1000479	11/32	\$ 118.00	HDL000038	\$ 22.00
1/4-28 UNF	TR1000480	TR1000482	11/32	TR1000481	TR1000483	11/32	\$ 118.00	HDL000038	\$ 22.00
1/4-32 UNEF	TR1000484	TR1000486	11/32	TR1000485	TR1000487	11/32	\$ 170.00	HDL000038	\$ 22.00
5/16-18 UNC	TR1000488	TR1000490	11/32	TR1000489	TR1000491	11/32	\$ 118.00	HDL000038	\$ 22.00
5/16-24 UNF	TR1000492	TR1000494	11/32	TR1000493	TR1000495	11/32	\$ 118.00	HDL000038	\$ 22.00
5/16-32 UNEF	TR1000496	TR1000498	11/32	TR1000497	TR1000499	11/32	\$ 170.00	HDL000038	\$ 22.00
3/8-16 UNC	TR1000500	TR1000502	7/16	TR1000501	TR1000503	7/16	\$ 130.00	HDL000039	\$ 23.00
3/8-24 UNF	TR1000504	TR1000506	7/16	TR1000505	TR1000507	7/16	\$ 130.00	HDL000039	\$ 23.00
3/8-32 UNEF	TR1000508	TR1000510	7/16	TR1000509	TR1000511	7/16	\$ 171.00	HDL000039	\$ 23.00
7/16-14 UNC	TR1000512	TR1000514	7/16	TR1000513	TR1000515	7/16	\$ 130.00	HDL000039	\$ 23.00
7/16-20 UNF	TR1000516	TR1000518	7/16	TR1000517	TR1000519	7/16	\$ 130.00	HDL000039	\$ 23.00
7/16-28 UNEF	TR1000520	TR1000522	7/16	TR1000521	TR1000523	7/16	\$ 173.00	HDL000039	\$ 23.00
1/2-13 UNC	TR1000524	TR1000526	7/16	TR1000525	TR1000527	7/16	\$ 136.00	HDL000039	\$ 23.00
1/2-20 UNF	TR1000528	TR1000530	7/16	TR1000529	TR1000531	7/16	\$ 136.00	HDL000039	\$ 23.00
1/2-28 UNEF	TR1000532	TR1000534	7/16	TR1000533	TR1000535	7/16	\$ 174.00	HDL000039	\$ 23.00
9/16-12 UNC	TR1000536	TR1000538	3/4	TR1000537	TR1000539	9/16	\$ 147.00	HDL000040	\$ 26.00
9/16-18 UNF	TR1000540	TR1000542	9/16	TR1000541	TR1000543	9/16	\$ 147.00	HDL000040	\$ 26.00
9/16-24 UNEF	TR1000544	TR1000546	9/16	TR1000545	TR1000547	9/16	\$ 187.00	HDL000040	\$ 26.00
5/8-11 UNC	TR1000548	TR1000550	3/4	TR1000549	TR1000551	9/16	\$ 147.00	HDL000040	\$ 26.00
5/8-18 UNF	TR1000552	TR1000554	9/16	TR1000553	TR1000555	9/16	\$ 147.00	HDL000040	\$ 26.00
5/8-24 UNEF	TR1000556	TR1000558	9/16	TR1000557	TR1000559	9/16	\$ 190.00	HDL000040	\$ 26.00
11/16-24 UNEF	TR1000560	TR1000562	9/16	TR1000561	TR1000563	9/16	\$ 222.00	HDL000040	\$ 26.00
3/4-10 UNC	TR1000564	TR1000566	3/4	TR1000565	TR1000567	9/16	\$ 186.00	HDL000040	\$ 26.00
3/4-16 UNF	TR1000568	TR1000570	9/16	TR1000569	TR1000571	9/16	\$ 186.00	HDL000040	\$ 26.00
3/4-20 UNEF	TR1000572	TR1000574	9/16	TR1000573	TR1000575	9/16	\$ 225.00	HDL000040	\$ 26.00
13/16-20 UNEF	TR1000576	TR1000578	9/16	TR1000577	TR1000579	9/16	\$ 241.00	HDL000040	\$ 26.00
7/8-9 UNC	TR1000580	TR1000582	15/16	TR1000581	TR1000583	11/16	\$ 204.00	HDL000041	\$ 35.00
7/8-14 UNF	TR1000584	TR1000586	11/16	TR1000585	TR1000587	11/16	\$ 204.00	HDL000041	\$ 35.00
7/8-20 UNEF	TR1000588	TR1000590	11/16	TR1000589	TR1000591	11/16	\$ 245.00	HDL000041	\$ 35.00
15/16-20 UNEF	TR1000592	TR1000594	11/16	TR1000593	TR1000595	11/16	\$ 260.00	HDL000041	\$ 35.00
1-8 UNC	TR1000596	TR1000598	15/16	TR1000597	TR1000599	11/16	\$ 255.00	HDL000041	\$ 35.00
1-12 UNF	TR1000600	TR1000602	11/16	TR1000603	TR1000605	11/16	\$ 255.00	HDL000041	\$ 35.00
1-14 UNS	TR1000604	TR1000606	11/16	TR1000605	TR1000607	11/16	\$ 255.00	HDL000041	\$ 35.00
1-20 UNEF	TR1000608	TR1000610	11/16	TR1000609	TR1000611	11/16	\$ 285.00	HDL000041	\$ 35.00
1 1/16-12 UN	TR1000612	TR1000614	11/16	TR1000613	TR1000615	11/16	\$ 304.00	HDL000041	\$ 35.00
1 1/16-18 UNEF	TR1000616	TR1000618	11/16	TR1000617	TR1000619	11/16	\$ 304.00	HDL000041	\$ 35.00
1 1/8-7 UNC	TR1000620	TR1000622	15/16	TR1000621	TR1000623	11/16	\$ 309.00	HDL000041	\$ 35.00
1 1/8-12 UNF	TR1000624	TR1000626	11/16	TR1000625	TR1000627	11/16	\$ 309.00	HDL000041	\$ 35.00
1 1/8-18 UNEF	TR1000628	TR1000630	11/16	TR1000629	TR1000631	11/16	\$ 325.00	HDL000041	\$ 35.00
1 3/16-12 UN	TR1000632	TR1000634	3/4	TR1000633	TR1000635	3/4	\$ 326.00	HDL000042	\$ 45.00
1 3/16-18 UNEF	TR1000636	TR1000638	3/4	TR1000637	TR1000639	3/4	\$ 326.00	HDL000042	\$ 45.00
1 1/4-7 UNC	TR1000640	TR1000642	1 1/8	TR1000641	TR1000643	3/4	\$ 334.00	HDL000042	\$ 45.00
1 1/4-12 UNF	TR1000644	TR1000646	3/4	TR1000645	TR1000647	3/4	\$ 334.00	HDL000042	\$ 45.00
1 1/4-18 UNEF	TR1000648	TR1000650	3/4	TR1000649	TR1000651	3/4	\$ 341.00	HDL000042	\$ 45.00
1 5/16-12 UN	TR1000652	TR1000654	3/4	TR1000653	TR1000655	3/4	\$ 351.00	HDL000042	\$ 45.00
1 5/16-18 UNEF	TR1000656	TR1000658	3/4	TR1000657	TR1000659	3/4	\$ 351.00	HDL000042	\$ 45.00
1 3/8-6 UNC	TR1000660	TR1000662	1 1/8	TR1000661	TR1000663	3/4	\$ 343.00	HDL000042	\$ 45.00
1 3/8-12 UNF	TR1000664	TR1000666	3/4	TR1000665	TR1000667	3/4	\$ 343.00	HDL000042	\$ 45.00
1 3/8-18 UNEF	TR1000668	TR1000670	3/4	TR1000669	TR1000671	3/4	\$ 357.00	HDL000042	\$ 45.00
1 7/16-12 UN	TR1000672	TR1000674	3/4	TR1000673	TR1000675	3/4	\$ 364.00	HDL000042	\$ 45.00
1 7/16-18 UNEF	TR1000676	TR1000678	3/4	TR1000677	TR1000679	3/4	\$ 364.00	HDL000042	\$ 45.00
1 1/2-6 UNC	TR1000680	TR1000682	1 1/8	TR1000681	TR1000683	3/4	\$ 371.00	HDL000042	\$ 45.00
1 1/2-12 UNF	TR1000684	TR1000686	3/4	TR1000685	TR1000687	3/4	\$ 371.00	HDL000042	\$ 45.00
1 1/2-18 UNEF	TR1000688	TR1000690	3/4	TR1000689	TR1000691	3/4	\$ 392.00	HDL000042	\$ 45.00
1 5/8-12 UN	TR1000692	TR1000694	13/16	TR1000693	TR1000695	13/16	\$ 412.00	NA	NA
1 3/4-12 UN	TR1000696	TR1000698	13/16	TR1000697	TR1000699	13/16	\$ 434.00	NA	NA
1 7/8-12 UN	TR1000700	TR1000702	13/16	TR1000701	TR1000703	13/16	\$ 455.00	NA	NA
2-12 UN	TR1000704	TR1000706	13/16	TR1000705	TR1000707	13/16	\$ 480.00	NA	NA
2 1/4-12 UN	TR1000708	TR1000710	7/8	TR1000709	TR1000711	7/8	\$ 509.00	NA	NA
2 1/2-12 UN	TR1000712	TR1000714	7/8	TR1000713	TR1000715	7/8	\$ 557.00	NA	NA

**AGD STYLE
THREAD RING GAGES**



The American Gage Design (AGD) adjustable Thread Ring Gage complies with ASME/ANSI B47.1 gage blank standard. AGD Style Thread Rings are made of oil hardened tool steel. Class and tolerance conform to ASME/ANSI B1.2 or B1.16M. Sizes below 1/4 / M6 are counterbored to hold specified length.

METRIC							
Nominal Price	Go Class 6g EDP #	Go Length "L"	NoGo Class 6g EDP #	NoGo Length "L"	STEEL Price	Holder EDP #	Holder Price
M 1.6 x 0.35	TR2000001	3/32	TR2000002	3/32	\$ 179.00	HDL000037	\$ 21.00
M 1.8 x 0.35	TR2000003	3/32	TR2000004	3/32	\$ 179.00	HDL000037	\$ 21.00
M 2.0 x 0.40	TR2000005	3/32	TR2000006	3/32	\$ 154.00	HDL000037	\$ 21.00
M 2.2 x 0.45	TR2000007	5/32	TR2000008	5/32	\$ 154.00	HDL000037	\$ 21.00
M 2.5 x 0.45	TR2000009	5/32	TR2000010	5/32	\$ 154.00	HDL000037	\$ 21.00
M 3.0 x 0.50	TR2000011	5/32	TR2000012	5/32	\$ 134.00	HDL000037	\$ 21.00
M 3.5 x 0.60	TR2000013	5/32	TR2000014	5/32	\$ 134.00	HDL000037	\$ 21.00
M 4.0 x 0.70	TR2000015	3/16	TR2000016	3/16	\$ 125.00	HDL000037	\$ 21.00
M 4.5 x 0.75	TR2000017	3/16	TR2000018	3/16	\$ 125.00	HDL000037	\$ 21.00
M 5.0 x 0.80	TR2000019	3/16	TR2000020	3/16	\$ 125.00	HDL000037	\$ 21.00
M 6.0 x 1.00	TR2000029	11/32	TR2000030	11/32	\$ 114.00	HDL000038	\$ 22.00
M 7.0 x 1.00	TR2000031	11/32	TR2000032	11/32	\$ 114.00	HDL000038	\$ 22.00
M 8.0 x 1.25	TR2000039	11/32	TR2000040	11/32	\$ 114.00	HDL000038	\$ 22.00
M 8.0 x 1.00	TR2000033	11/32	TR2000034	11/32	\$ 114.00	HDL000038	\$ 22.00
M10.0 x 1.00	TR2000198	7/16	TR2000199	7/16	\$ 125.00	HDL000039	\$ 23.00
M 10.0 x 1.50	TR2000041	7/16	TR2000042	7/16	\$ 125.00	HDL000039	\$ 23.00
M 10.0 x 1.25	TR2000035	7/16	TR2000036	7/16	\$ 125.00	HDL000039	\$ 23.00
M 12.0 x 1.75	TR2000059	7/16	TR2000060	7/16	\$ 133.00	HDL000039	\$ 23.00
M 12.0 x 1.50	TR2000043	7/16	TR2000044	7/16	\$ 133.00	HDL000039	\$ 23.00
M 12.0 x 1.25	TR2000037	7/16	TR2000038	7/16	\$ 128.00	HDL000039	\$ 23.00
M 12.0 x 1.00	TR2000021	7/16	TR2000022	7/16	\$ 190.00	HDL000039	\$ 23.00
M 14.0 x 2.00	TR2000061	9/16	TR2000062	9/16	\$ 148.00	HDL000040	\$ 26.00
M 14.0 x 1.50	TR2000045	9/16	TR2000046	9/16	\$ 148.00	HDL000040	\$ 26.00
M 14.0 x 1.00	TR2000023	9/16	TR2000024	9/16	\$ 202.00	HDL000040	\$ 26.00
M 15.0 x 1.00	TR2000025	9/16	TR2000026	9/16	\$ 148.00	HDL000040	\$ 26.00
M 16.0 x 2.00	TR2000063	9/16	TR2000064	9/16	\$ 148.00	HDL000040	\$ 26.00
M 16.0 x 1.50	TR2000047	9/16	TR2000048	9/16	\$ 148.00	HDL000040	\$ 26.00
M 17.0 x 1.00	TR2000027	9/16	TR2000028	9/16	\$ 193.00	HDL000040	\$ 26.00
M 18.0 x 2.50	TR2000077	3/4	TR2000078	9/16	\$ 216.00	HDL000040	\$ 26.00
M 18.0 x 1.50	TR2000049	9/16	TR2000050	9/16	\$ 198.00	HDL000040	\$ 26.00
M 20.0 x 2.50	TR2000079	3/4	TR2000080	9/16	\$ 245.00	HDL000040	\$ 26.00
M 20.0 x 1.50	TR2000051	9/16	TR2000052	9/16	\$ 245.00	HDL000040	\$ 26.00
M 22.0 x 2.50	TR2000081	15/16	TR2000082	11/16	\$ 249.00	HDL000041	\$ 35.00
M 22.0 x 1.50	TR2000053	11/16	TR2000054	11/16	\$ 249.00	HDL000041	\$ 35.00
M 24.0 x 3.00	TR2000083	15/16	TR2000084	11/16	\$ 287.00	HDL000041	\$ 35.00
M 24.0 x 2.00	TR2000065	11/16	TR2000066	11/16	\$ 287.00	HDL000041	\$ 35.00
M 27.0 x 3.00	TR2000085	15/16	TR2000086	11/16	\$ 300.00	HDL000042	\$ 45.00
M 27.0 x 2.00	TR2000067	11/16	TR2000068	11/16	\$ 300.00	HDL000042	\$ 45.00
M 30.0 x 3.50	TR2000091	1 1/8	TR2000092	3/4	\$ 303.00	HDL000042	\$ 45.00
M 30.0 x 2.00	TR2000069	3/4	TR2000070	3/4	\$ 303.00	HDL000042	\$ 45.00
M 30.0 x 1.50	TR2000055	3/4	TR2000056	3/4	\$ 303.00	HDL000042	\$ 45.00
M 33.0 x 3.50	TR2000093	1 1/8	TR2000094	3/4	\$ 336.00	HDL000042	\$ 45.00
M35.0 x 1.50	TR2000071	3/4	TR2000072	3/4	\$ 336.00	HDL000042	\$ 45.00
M36.0 x 4.00	TR2000057	3/4	TR2000058	3/4	\$ 352.00	HDL000042	\$ 45.00
M 36.0 x 4.00	TR2000095	1 1/8	TR2000096	3/4	\$ 375.00	HDL000042	\$ 45.00
M 36.0 x 3.00	TR2000087	1 1/8	TR2000088	3/4	\$ 375.00	HDL000042	\$ 45.00
M 36.0 x 2.00	TR2000073	3/4	TR2000074	3/4	\$ 375.00	HDL000042	\$ 45.00
M 39.0 x 4.00	TR2000097	1 1/8	TR2000098	13/16	\$ 382.00	NA	NA
M 39.0 x 3.00	TR2000089	1 1/8	TR2000090	13/16	\$ 382.00	NA	NA
M 39.0 x 2.00	TR2000075	13/16	TR2000076	13/16	\$ 382.00	NA	NA

**AGD STYLE
THREAD RING GAGES**

INCH									
Nominal Size	Go Class 2A EDP #	Go Class 3A EDP #	Go Length "L"	NoGo Class 2A EDP #	NoGo Class 3A EDP #	NoGo Length "L"	STEEL Price	Holder EDP #	Holder Price
0-80 (.060) UNF	TR1000001	TR1000003	3/32	TR1000002	TR1000004	3/32	\$ 154.00	HDL000037	\$ 21.00
1-64 (.073) UNC	TR1000005	TR1000007	3/32	TR1000006	TR1000008	3/32	\$ 140.00	HDL000037	\$ 21.00
1-72 (.073) UNF	TR1000009	TR1000011	3/32	TR1000010	TR1000012	3/32	\$ 140.00	HDL000037	\$ 21.00
2-56 (.086) UNC	TR1000013	TR1000015	3/32	TR1000014	TR1000016	3/32	\$ 130.00	HDL000037	\$ 21.00
2-64 (.086) UNF	TR1000017	TR1000019	3/32	TR1000018	TR1000020	3/32	\$ 130.00	HDL000037	\$ 21.00
3-48 (.099) UNC	TR1000021	TR1000023	5/32	TR1000022	TR1000024	5/32	\$ 130.00	HDL000037	\$ 21.00
3-56 (.099) UNF	TR1000025	TR1000027	5/32	TR1000026	TR1000028	5/32	\$ 130.00	HDL000037	\$ 21.00
4-40 (.112) UNC	TR1000029	TR1000031	5/32	TR1000030	TR1000032	5/32	\$ 121.00	HDL000037	\$ 21.00
4-48 (.112) UNF	TR1000033	TR1000035	5/32	TR1000034	TR1000036	5/32	\$ 121.00	HDL000037	\$ 21.00
5-40 (.125) UNC	TR1000037	TR1000039	5/32	TR1000038	TR1000040	5/32	\$ 105.00	HDL000037	\$ 21.00
5-44 (.125) UNF	TR1000041	TR1000043	5/32	TR1000042	TR1000044	5/32	\$ 105.00	HDL000037	\$ 21.00
6-32 (.138) UNC	TR1000045	TR1000047	5/32	TR1000046	TR1000048	5/32	\$ 105.00	HDL000037	\$ 21.00
6-40 (.138) UNF	TR1000049	TR1000051	5/32	TR1000050	TR1000052	5/32	\$ 105.00	HDL000037	\$ 21.00
8-32 (.164) UNC	TR1000053	TR1000055	3/16	TR1000054	TR1000056	3/16	\$ 101.00	HDL000037	\$ 21.00
8-36 (.164) UNF	TR1000057	TR1000059	3/16	TR1000058	TR1000060	3/16	\$ 101.00	HDL000037	\$ 21.00
10-24 (.190) UNC	TR1000061	TR1000063	3/16	TR1000062	TR1000064	3/16	\$ 101.00	HDL000037	\$ 21.00
10-32 (.190) UNF	TR1000065	TR1000067	3/16	TR1000066	TR1000068	3/16	\$ 101.00	HDL000037	\$ 21.00
12-24 (.216) UNC	TR1000069	TR1000071	3/16	TR1000070	TR1000072	3/16	\$ 101.00	HDL000037	\$ 21.00
12-28 (.216) UNF	TR1000073	TR1000075	3/16	TR1000074	TR1000076	3/16	\$ 101.00	HDL000037	\$ 21.00
12-32 (.216) UNEF	TR1000077	TR1000079	11/32	TR1000078	TR1000080	11/32	\$ 128.00	HDL000037	\$ 21.00
1/4-20 UNC	TR1000081	TR1000083	11/32	TR1000082	TR1000084	11/32	\$ 102.00	HDL000038	\$ 22.00
1/4-28 UNF	TR1000085	TR1000087	11/32	TR1000086	TR1000088	11/32	\$ 102.00	HDL000038	\$ 22.00
1/4-32 UNEF	TR1000089	TR1000091	11/32	TR1000090	TR1000092	11/32	\$ 128.00	HDL000038	\$ 22.00
5/16-18 UNC	TR1000093	TR1000095	11/32	TR1000094	TR1000096	11/32	\$ 99.00	HDL000038	\$ 22.00
5/16-24 UNF	TR1000097	TR1000099	11/32	TR1000098	TR1000100	11/32	\$ 99.00	HDL000038	\$ 22.00
5/16-32 UNEF	TR1000101	TR1000103	7/16	TR1000102	TR1000104	7/16	\$ 128.00	HDL000038	\$ 22.00
3/8-16 UNC	TR1000105	TR1000107	7/16	TR1000106	TR1000108	7/16	\$ 110.00	HDL000039	\$ 23.00
3/8-24 UNF	TR1000109	TR1000111	7/16	TR1000110	TR1000112	7/16	\$ 110.00	HDL000039	\$ 23.00
3/8-32 UNEF	TR1000113	TR1000115	7/16	TR1000114	TR1000116	7/16	\$ 134.00	HDL000039	\$ 23.00
7/16-14 UNC	TR1000117	TR1000119	7/16	TR1000118	TR1000120	7/16	\$ 105.00	HDL000039	\$ 23.00
7/16-20 UNF	TR1000121	TR1000123	7/16	TR1000122	TR1000124	7/16	\$ 105.00	HDL000039	\$ 23.00
7/16-28 UNEF	TR1000125	TR1000127	7/16	TR1000126	TR1000128	7/16	\$ 130.00	HDL000039	\$ 23.00
1/2-13 UNC	TR1000129	TR1000131	7/16	TR1000130	TR1000132	7/16	\$ 110.00	HDL000039	\$ 23.00
1/2-20 UNF	TR1000133	TR1000135	7/16	TR1000134	TR1000136	7/16	\$ 110.00	HDL000039	\$ 23.00
1/2-28 UNEF	TR1000137	TR1000139	3/4	TR1000138	TR1000140	9/16	\$ 135.00	HDL000039	\$ 23.00
9/16-12 UNC	TR1000141	TR1000143	9/16	TR1000142	TR1000144	9/16	\$ 128.00	HDL000040	\$ 26.00
9/16-18 UNF	TR1000145	TR1000147	9/16	TR1000146	TR1000148	9/16	\$ 128.00	HDL000040	\$ 26.00
9/16-24 UNEF	TR1000149	TR1000151	3/4	TR1000150	TR1000152	9/16	\$ 134.00	HDL000040	\$ 26.00
5/8-11 UNC	TR1000153	TR1000155	9/16	TR1000154	TR1000156	9/16	\$ 128.00	HDL000040	\$ 26.00
5/8-18 UNF	TR1000157	TR1000159	9/16	TR1000158	TR1000160	9/16	\$ 128.00	HDL000040	\$ 26.00
5/8-24 UNEF	TR1000161	TR1000163	9/16	TR1000162	TR1000164	9/16	\$ 177.00	HDL000040	\$ 26.00
11/16-24 UNEF	TR1000165	TR1000167	3/4	TR1000166	TR1000168	9/16	\$ 142.00	HDL000040	\$ 26.00
3/4-10 UNC	TR1000169	TR1000171	9/16	TR1000170	TR1000172	9/16	\$ 158.00	HDL000040	\$ 26.00
3/4-16 UNF	TR1000173	TR1000175	9/16	TR1000174	TR1000176	9/16	\$ 158.00	HDL000040	\$ 26.00
3/4-20 UNEF	TR1000177	TR1000179	9/16	TR1000178	TR1000180	9/16	\$ 193.00	HDL000040	\$ 26.00
13/16-20 UNEF	TR1000181	TR1000183	15/16	TR1000182	TR1000184	11/16	\$ 197.00	HDL000040	\$ 26.00
7/8-9 UNC	TR1000185	TR1000187	11/16	TR1000186	TR1000188	11/16	\$ 170.00	HDL000041	\$ 35.00
7/8-14 UNF	TR1000189	TR1000191	11/16	TR1000190	TR1000192	11/16	\$ 170.00	HDL000041	\$ 35.00
7/8-20 UNEF	TR1000193	TR1000195	11/16	TR1000194	TR1000196	11/16	\$ 204.00	HDL000041	\$ 35.00
15/16-20 UNEF	TR1000197	TR1000199	15/16	TR1000198	TR1000200	11/16	\$ 204.00	HDL000041	\$ 35.00
1-8 UNC	TR1000201	TR1000203	11/16	TR1000202	TR1000204	11/16	\$ 209.00	HDL000041	\$ 35.00
1-12 UNF	TR1000205	TR1000207	11/16	TR1000206	TR1000208	11/16	\$ 209.00	HDL000041	\$ 35.00
1-14 UNS	TR1000209	TR1000211	11/16	TR1000210	TR1000212	11/16	\$ 209.00	HDL000041	\$ 35.00
1-20 UNEF	TR1000213	TR1000215	11/16	TR1000214	TR1000216	11/16	\$ 237.00	HDL000041	\$ 35.00
1 1/16-12 UN	TR1000217	TR1000219	11/16	TR1000218	TR1000220	11/16	\$ 253.00	HDL000041	\$ 35.00
1 1/16-18 UNEF	TR1000221	TR1000223	15/16	TR1000222	TR1000224	11/16	\$ 266.00	HDL000041	\$ 35.00
1 1/8-7 UNC	TR1000225	TR1000227	11/16	TR1000226	TR1000228	11/16	\$ 270.00	HDL000041	\$ 35.00
1 1/8-12 UNF	TR1000229	TR1000231	11/16	TR1000230	TR1000232	11/16	\$ 270.00	HDL000041	\$ 35.00
1 1/8-18 UNEF	TR1000233	TR1000235	3/4	TR1000234	TR1000236	3/4	\$ 274.00	HDL000041	\$ 35.00
1 3/16-12 UN	TR1000237	TR1000239	3/4	TR1000238	TR1000240	3/4	\$ 277.00	HDL000041	\$ 35.00
1 3/16-18 UNEF	TR1000241	TR1000243	1 1/8	TR1000242	TR1000244	3/4	\$ 280.00	HDL000042	\$ 45.00
1 1/4-7 UNC	TR1000245	TR1000247	3/4	TR1000246	TR1000248	3/4	\$ 277.00	HDL000042	\$ 45.00
1 1/4-12 UNF	TR1000249	TR1000251	3/4	TR1000250	TR1000252	3/4	\$ 277.00	HDL000042	\$ 45.00
1 1/4-18 UNEF	TR1000253	TR1000255	3/4	TR1000254	TR1000256	3/4	\$ 283.00	HDL000042	\$ 45.00
1 5/16-12 UN	TR1000257	TR1000259	3/4	TR1000258	TR1000260	3/4	\$ 287.00	HDL000042	\$ 45.00
1 3/8-6 UNC	TR1000261	TR1000263	1 1/8	TR1000262	TR1000264	3/4	\$ 289.00	HDL000042	\$ 45.00
1 3/8-6 UNC	TR1000265	TR1000267	3/4	TR1000266	TR1000268	3/4	\$ 285.00	HDL000042	\$ 45.00
1 3/8-12 UNF	TR1000269	TR1000271	3/4	TR1000270	TR1000272	3/4	\$ 285.00	HDL000042	\$ 45.00
1 3/8-18 UNEF	TR1000273	TR1000275	3/4	TR1000274	TR1000276	3/4	\$ 302.00	HDL000042	\$ 45.00
1 7/16-18 UNEF	TR1000277	TR1000279	3/4	TR1000278	TR1000280	3/4	\$ 302.00	HDL000042	\$ 45.00
1 1/2-6 UNC	TR1000281	TR1000283	1 1/8	TR1000282	TR1000284	3/4	\$ 307.00	HDL000042	\$ 45.00
1 1/2-12 UNF	TR1000285	TR1000287	3/4	TR1000286	TR1000288	3/4	\$ 307.00	HDL000042	\$ 45.00
1 1/2-18 UNEF	TR1000289	TR1000291	3/4	TR1000290	TR1000292	3/4	\$ 325.00	HDL000042	\$ 45.00
1 3/4-12 UN	TR1000293	TR1000294	13/16	TR1000295	TR1000296	13/16	\$ 361.00	NA	NA
2"-12 UN	TR1000297	TR1000298	13/16	TR1000299	TR1000300	13/16	\$ 398.00	NA	NA
2 1/4-12 UN	TR1000301	TR1000302	7/8	TR1000303	TR1000304	7/8	\$ 425.00	NA	NA
2 1/2-12 UN	TR1000305	TR1000306	7/8	TR1000307	TR1000308	7/8	\$ 461.00	NA	NA

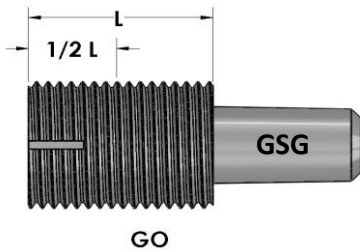

GO

**TRUNCATED
SET PLUG GAGES
STEEL**

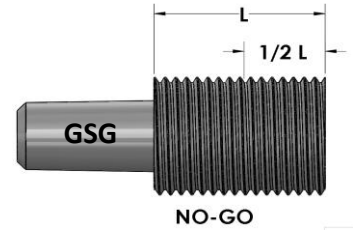

NO-GO

Truncated Set Plug Gages are used to set/calibrate Thread Ring Gages. Truncated Set Plug Gages have a common pitch diameter the full thread length with the front portion of the major diameter truncated leaving the rear portion full form. Truncated Set Plug Gages are manufactured to ASME/ANSI B47.1 AGD standard and ASME/ANSI B1.2 or B1.16M. Thread lead, flank angles & straightness conform to class W tolerances, pitch diameter conforms to class X tolerances. For pitch diameter to class W tolerances add 25% to the prices listed. All gages are manufactured of oil hardened tool steel.

Progressive Set Masters (Hi-Lo) available upon request.

METRIC

Nominal Size	Go Class 6g EDP #	Go Length "L"	NoGo Class 6g EDP #	NoGo Length "L"	STEEL Price	Handle EDP #	Handle #	Handle Price	Double End Go/NoGo/Hdle Price
M1.6 x 0.35	TPS200151	7/32	TPS200150	7/32	\$ 124.00	HDL000001	000	\$ 11.00	\$ 259.00
M1.8 x 0.35	TPS200153	7/32	TPS200152	7/32	\$ 124.00	HDL000001	000	\$ 11.00	\$ 259.00
M2.0 x 0.40	TPS200155	7/32	TPS200154	7/32	\$ 116.00	HDL000001	000	\$ 11.00	\$ 243.00
M2.2 x 0.45	TPS200157	7/32	TPS200156	7/32	\$ 116.00	HDL000001	000	\$ 11.00	\$ 243.00
M2.5 x 0.45	TPS200159	3/8	TPS200158	3/8	\$ 116.00	HDL000001	000	\$ 11.00	\$ 243.00
M3.0 x 0.50	TPS200161	3/8	TPS200160	3/8	\$ 113.00	HDL000002	00	\$ 11.00	\$ 237.00
M3.5 x 0.60	TPS200163	3/8	TPS200162	3/8	\$ 113.00	HDL000002	00	\$ 11.00	\$ 237.00
M4.0 x 0.70	TPS200164	13/32	TPS200165	13/32	\$ 110.00	HDL000003	0	\$ 11.00	\$ 231.00
M4.5 x 0.75	TPS200166	13/32	TPS200167	13/32	\$ 110.00	HDL000003	0	\$ 11.00	\$ 231.00
M5.0 x 0.80	TPS200168	13/32	TPS200169	13/32	\$ 110.00	HDL000003	0	\$ 11.00	\$ 231.00
M6.0 x 1.00	TPS200170	3/4	TPS200171	3/4	\$ 99.00	HDL000004	1	\$ 10.00	\$ 208.00
M7.0 x 1.00	TPS200172	3/4	TPS200173	3/4	\$ 99.00	HDL000004	1	\$ 10.00	\$ 208.00
M8.0 x 1.25	TPS200176	3/4	TPS200177	3/4	\$ 99.00	HDL000004	1	\$ 10.00	\$ 208.00
M8.0 x 1.00	TPS200174	3/4	TPS200175	3/4	\$ 99.00	HDL000004	1	\$ 10.00	\$ 208.00
M10.0 x 1.00	TPS200182	1	TPS200183	1	\$ 105.00	HDL000009	2	\$ 10.00	\$ 220.00
M10.0 x 1.50	TPS200178	1	TPS200179	1	\$ 105.00	HDL000009	2	\$ 10.00	\$ 220.00
M10.0 x 1.25	TPS200180	1	TPS200181	1	\$ 105.00	HDL000009	2	\$ 10.00	\$ 220.00
M12.0 x 1.75	TPS200184	1	TPS200185	1	\$ 110.00	HDL000009	2	\$ 10.00	\$ 230.00
M12.0 x 1.50	TPS200186	1	TPS200187	1	\$ 110.00	HDL000009	2	\$ 10.00	\$ 230.00
M12.0 x 1.25	TPS200188	1	TPS200189	1	\$ 110.00	HDL000009	2	\$ 10.00	\$ 230.00
M12.0 x 1.00	TPS200190	1	TPS200191	1	\$ 110.00	HDL000009	2	\$ 10.00	\$ 230.00
M14.0 x 2.00	TPS200192	1 1/4	TPS200193	1 1/4	\$ 127.00	HDL000014	3	\$ 10.00	\$ 264.00
M14.0 x 1.50	TPS200194	1 1/4	TPS200195	1 1/4	\$ 127.00	HDL000014	3	\$ 10.00	\$ 264.00
M14.0 x 1.00	TPS200196	1 1/4	TPS200197	1 1/4	\$ 127.00	HDL000014	3	\$ 10.00	\$ 264.00
M15.0 x 1.00	TPS200198	1 1/4	TPS200199	1 1/4	\$ 127.00	HDL000014	3	\$ 10.00	\$ 264.00
M16.0 x 2.00	TPS200200	1 1/4	TPS200201	1 1/4	\$ 127.00	HDL000014	3	\$ 10.00	\$ 264.00
M16.0 x 1.50	TPS200202	1 1/4	TPS200203	1 1/4	\$ 127.00	HDL000014	3	\$ 10.00	\$ 264.00
M17.0 x 1.00	TPS200204	1 1/4	TPS200205	1 1/4	\$ 140.00	HDL000014	3	\$ 10.00	\$ 290.00
M18.0 x 2.50	TPS200206	1 7/8	TPS200207	1 1/4	\$ 140.00	HDL000014	3	\$ 10.00	\$ 290.00
M18.0 x 1.50	TPS200208	1 1/4	TPS200209	1 1/4	\$ 135.00	HDL000014	3	\$ 10.00	\$ 280.00
M20.0 x 2.50	TPS200210	1 7/8	TPS200211	1 1/4	\$ 140.00	HDL000014	3	\$ 10.00	\$ 290.00
M20.0 x 1.50	TPS200212	1 1/4	TPS200213	1 1/4	\$ 140.00	HDL000014	3	\$ 10.00	\$ 290.00
M22.0 x 2.50	TPS200214	2 1/8	TPS200215	1 1/2	\$ 198.00	HDL000019	4	\$ 11.00	\$ 407.00
M22.0 x 1.50	TPS200216	1 1/2	TPS200217	1 1/2	\$ 198.00	HDL000019	4	\$ 11.00	\$ 407.00
M24.0 x 3.00	TPS200218	2 1/8	TPS200219	1 1/2	\$ 200.00	HDL000019	4	\$ 11.00	\$ 411.00
M24.0 x 2.00	TPS200220	1 1/2	TPS200221	1 1/2	\$ 200.00	HDL000019	4	\$ 11.00	\$ 411.00
M27.0 x 3.00	TPS200222	1 1/8	TPS200223	1 1/2	\$ 213.00	HDL000019	4	\$ 11.00	\$ 437.00
M27.0 x 2.00	TPS200224	1 1/2	TPS200225	1 1/2	\$ 213.00	HDL000019	4	\$ 11.00	\$ 437.00
M30.0 x 3.50	TPS200226	2 3/8	TPS200227	1 5/8	\$ 216.00	HDL000024	5	\$ 12.00	\$ 444.00
M30.0 x 2.00	TPS200228	1 5/8	TPS200229	1 5/8	\$ 216.00	HDL000024	5	\$ 12.00	\$ 444.00
M30.0 x 1.50	TPS200230	1 5/8	TPS200231	1 5/8	\$ 216.00	HDL000024	5	\$ 12.00	\$ 444.00
M33.0 x 3.50	TPS200232	2 3/8	TPS200233	1 5/8	\$ 227.00	HDL000024	5	\$ 12.00	\$ 466.00
M33.0 x 2.00	TPS200234	1 5/8	TPS200235	1 5/8	\$ 227.00	HDL000024	5	\$ 12.00	\$ 466.00
M35.0 x 1.50	TPS200236	1 5/8	TPS200237	1 5/8	\$ 237.00	HDL000024	5	\$ 12.00	\$ 486.00
M36.0 x 4.00	TPS200238	2 3/8	TPS200239	1 5/8	\$ 245.00	HDL000024	5	\$ 12.00	\$ 502.00
M36.0 x 3.00	TPS200240	2 3/8	TPS200241	1 5/8	\$ 245.00	HDL000024	5	\$ 12.00	\$ 502.00
M36.0 x 2.00	TPS200242	1 5/8	TPS200243	1 5/8	\$ 245.00	HDL000024	5	\$ 12.00	\$ 502.00
M39.0 x 4.00	TPS200244	2 7/8	TPS200245	1 7/8	\$ 255.00	HDL000023	5 1/2	\$ 16.00	\$ 526.00
M39.0 x 3.00	TPS200246	2 7/8	TPS200247	1 7/8	\$ 255.00	HDL000023	5 1/2	\$ 16.00	\$ 526.00
M39.0 x 2.00	TPS200249	1 7/8	TPS200251	1 7/8	\$ 255.00	HDL000023	5 1/2	\$ 16.00	\$ 526.00

**TRUNCATED
SET PLUG GAGES**

INCH											
Nominal Size	Go Class 2A EDP #	Go Class 3A EDP #	Go Length "L"	NoGo Class 2A EDP #	NoGo Class 3A EDP #	NoGo Length "L"	STEEL Price	Handle EDP #	Handle #	Handle Price	Double End Go/NoGo/Handle Price
0-80 (.060) UNF	TPS100501	TPS100500	7/32	TPS100503	TPS100502	7/32	\$ 111.00	HDL000001	000	\$ 11.00	\$ 233.00
1-64 (.073) UNC	TPS100505	TPS100504	7/32	TPS100509	TPS100508	7/32	\$ 111.00	HDL000001	000	\$ 11.00	\$ 233.00
1-72 (.073) UNF	TPS100507	TPS100506	7/32	TPS100511	TPS100510	7/32	\$ 111.00	HDL000001	000	\$ 11.00	\$ 233.00
2-56 (.086) UNC	TPS100513	TPS100512	7/32	TPS100517	TPS100516	7/32	\$ 111.00	HDL000001	000	\$ 11.00	\$ 233.00
2-64 (.086) UNF	TPS100515	TPS100514	7/32	TPS100519	TPS100518	7/32	\$ 111.00	HDL000001	000	\$ 11.00	\$ 233.00
3-48 (.099) UNC	TPS100521	TPS100520	3/8	TPS100525	TPS100524	3/8	\$ 103.00	HDL000001	000	\$ 11.00	\$ 217.00
3-56 (.099) UNF	TPS100523	TPS100522	3/8	TPS100527	TPS100526	3/8	\$ 103.00	HDL000001	000	\$ 11.00	\$ 217.00
4-40 (.112) UNC	TPS100529	TPS100528	3/8	TPS100533	TPS100532	3/8	\$ 93.00	HDL000002	00	\$ 11.00	\$ 197.00
4-48 (.112) UNF	TPS100531	TPS100530	3/8	TPS100535	TPS100534	3/8	\$ 93.00	HDL000002	00	\$ 11.00	\$ 197.00
5-40 (.125) UNC	TPS100537	TPS100536	3/8	TPS100541	TPS100540	3/8	\$ 86.00	HDL000002	00	\$ 11.00	\$ 183.00
5-44 (.125) UNF	TPS100539	TPS100538	3/8	TPS100543	TPS100542	3/8	\$ 86.00	HDL000002	00	\$ 11.00	\$ 183.00
6-32 (.138) UNC	TPS100545	TPS100544	3/8	TPS100549	TPS100548	3/8	\$ 86.00	HDL000002	00	\$ 11.00	\$ 183.00
6-40 (.138) UNF	TPS100547	TPS100546	3/8	TPS100551	TPS100550	3/8	\$ 86.00	HDL000002	00	\$ 11.00	\$ 183.00
8-32 (.164) UNC	TPS100553	TPS100552	13/32	TPS100557	TPS100556	13/32	\$ 86.00	HDL000003	0	\$ 11.00	\$ 183.00
8-36 (.164) UNF	TPS100554	TPS100553	13/32	TPS100558	TPS100557	13/32	\$ 86.00	HDL000003	0	\$ 11.00	\$ 183.00
10-24 (.190) UNC	TPS100561	TPS100560	13/32	TPS100565	TPS100564	13/32	\$ 86.00	HDL000003	0	\$ 11.00	\$ 183.00
10-32 (.190) UNF	TPS100563	TPS100562	13/32	TPS100567	TPS100566	13/32	\$ 86.00	HDL000003	0	\$ 11.00	\$ 183.00
12-24 (.216) UNC	TPS100569	TPS100568	13/32	TPS100573	TPS100572	13/32	\$ 93.00	HDL000003	0	\$ 11.00	\$ 197.00
12-28 (.216) UNF	TPS100571	TPS100570	13/32	TPS100575	TPS100574	13/32	\$ 93.00	HDL000003	0	\$ 11.00	\$ 197.00
12-32 (.216) UNEF	TPS100573	TPS100572	13/32	TPS100577	TPS100576	13/32	\$ 111.00	HDL000003	0	\$ 11.00	\$ 233.00
1/4-20 UNC	TPS100581	TPS100580	3/4	TPS100585	TPS100584	3/4	\$ 79.00	HDL000004	1	\$ 10.00	\$ 168.00
1/4-28 UNF	TPS100583	TPS100582	3/4	TPS100587	TPS100586	3/4	\$ 79.00	HDL000004	1	\$ 10.00	\$ 168.00
1/4-32 UNEF	TPS100585	TPS100584	3/4	TPS100589	TPS100588	3/4	\$ 113.00	HDL000004	1	\$ 10.00	\$ 236.00
5/16-18 UNC	TPS100593	TPS100592	3/4	TPS100597	TPS100596	3/4	\$ 79.00	HDL000004	1	\$ 10.00	\$ 168.00
5/16-24 UNF	TPS100595	TPS100594	3/4	TPS100601	TPS100600	3/4	\$ 79.00	HDL000004	1	\$ 10.00	\$ 168.00
5/16-32 UNEF	TPS100597	TPS100596	3/4	TPS100603	TPS100602	3/4	\$ 113.00	HDL000004	1	\$ 10.00	\$ 236.00
3/8-16 UNC	TPS100605	TPS100604	1	TPS100609	TPS100608	1	\$ 82.00	HDL000009	2	\$ 10.00	\$ 174.00
3/8-24 UNF	TPS100607	TPS100606	1	TPS100611	TPS100610	1	\$ 82.00	HDL000009	2	\$ 10.00	\$ 174.00
3/8-32 UNEF	TPS100609	TPS100608	1	TPS100613	TPS100612	1	\$ 134.00	HDL000009	2	\$ 10.00	\$ 278.00
7/16-14 UNC	TPS100617	TPS100616	1	TPS100615	TPS100614	1	\$ 87.00	HDL000009	2	\$ 10.00	\$ 184.00
7/16-20 UNF	TPS100619	TPS100618	1	TPS100623	TPS100622	1	\$ 87.00	HDL000009	2	\$ 10.00	\$ 184.00
7/16-28 UNEF	TPS100621	TPS100620	1	TPS100627	TPS100626	1	\$ 134.00	HDL000009	2	\$ 10.00	\$ 278.00
1/2-13 UNC	TPS100629	TPS100628	1	TPS100631	TPS100630	1	\$ 90.00	HDL000009	2	\$ 10.00	\$ 190.00
1/2-20 UNF	TPS100631	TPS100630	1	TPS100635	TPS100634	1	\$ 90.00	HDL000009	2	\$ 10.00	\$ 190.00
1/2-28 UNEF	TPS100633	TPS100632	1	TPS100637	TPS100636	1	\$ 90.00	HDL000009	2	\$ 10.00	\$ 190.00
9/16-12 UNC	TPS100641	TPS100640	1 1/8	TPS100639	TPS100638	1	\$ 147.00	HDL000009	2	\$ 10.00	\$ 304.00
9/16-18 UNF	TPS100643	TPS100642	1 1/4	TPS100647	TPS100646	1 1/4	\$ 103.00	HDL000014	3	\$ 10.00	\$ 216.00
9/16-24 UNEF	TPS100645	TPS100644	1 1/4	TPS100649	TPS100648	1 1/4	\$ 103.00	HDL000014	3	\$ 10.00	\$ 216.00
5/8-11 UNC	TPS100653	TPS100652	1 7/8	TPS100651	TPS100650	1 1/4	\$ 158.00	HDL000014	3	\$ 10.00	\$ 326.00
5/8-18 UNF	TPS100655	TPS100654	1 1/4	TPS100659	TPS100658	1 1/4	\$ 108.00	HDL000014	3	\$ 10.00	\$ 226.00
5/8-24 UNEF	TPS100657	TPS100656	1 1/4	TPS100661	TPS100660	1 1/4	\$ 108.00	HDL000014	3	\$ 10.00	\$ 226.00
11/16-24 UNEF	TPS100665	TPS100664	1 1/4	TPS100663	TPS100662	1 1/4	\$ 159.00	HDL000014	3	\$ 10.00	\$ 328.00
3/4-10 UNC	TPS100669	TPS100668	1 7/8	TPS100667	TPS100666	1 1/4	\$ 173.00	HDL000014	3	\$ 10.00	\$ 356.00
3/4-16 UNF	TPS100671	TPS100670	1 1/4	TPS100675	TPS100674	1 1/4	\$ 124.00	HDL000014	3	\$ 10.00	\$ 258.00
3/4-20 UNEF	TPS100673	TPS100672	1 1/4	TPS100677	TPS100676	1 1/4	\$ 124.00	HDL000014	3	\$ 10.00	\$ 258.00
13/16-20 UNEF	TPS100681	TPS100680	1 1/4	TPS100679	TPS100678	1 1/4	\$ 166.00	HDL000014	3	\$ 10.00	\$ 342.00
7/8-9 UNC	TPS100685	TPS100684	2 1/8	TPS100683	TPS100682	1 1/4	\$ 176.00	HDL000014	3	\$ 10.00	\$ 362.00
7/8-14 UNF	TPS100687	TPS100686	1 1/2	TPS100691	TPS100690	1 1/2	\$ 146.00	HDL000019	4	\$ 11.00	\$ 303.00
7/8-20 UNEF	TPS100689	TPS100688	1 1/2	TPS100693	TPS100692	1 1/2	\$ 146.00	HDL000019	4	\$ 11.00	\$ 303.00
15/16-20 UNEF	TPS100697	TPS100696	1 1/2	TPS100695	TPS100694	1 1/2	\$ 182.00	HDL000019	4	\$ 11.00	\$ 375.00
1-8 UNC	TPS100701	TPS100700	2 1/8	TPS100699	TPS100698	1 1/2	\$ 185.00	HDL000019	4	\$ 11.00	\$ 381.00
1-12 UNF	TPS100703	TPS100702	1 1/2	TPS100709	TPS100708	1 1/2	\$ 166.00	HDL000019	4	\$ 11.00	\$ 343.00
1-14 UNS	TPS100705	TPS100704	1 1/2	TPS100711	TPS100710	1 1/2	\$ 166.00	HDL000019	4	\$ 11.00	\$ 343.00
1-20 UNEF	TPS100707	TPS100706	1 1/2	TPS100713	TPS100712	1 1/2	\$ 166.00	HDL000019	4	\$ 11.00	\$ 343.00
1 1/16-12 UN	TPS100717	TPS100716	1 1/2	TPS100715	TPS100714	1 1/2	\$ 198.00	HDL000019	4	\$ 11.00	\$ 407.00
1 1/16-18 UNEF	TPS100719	TPS100718	1 1/2	TPS100721	TPS100720	1 1/2	\$ 193.00	HDL000019	4	\$ 11.00	\$ 397.00
1 1/8-7 UNC	TPS100725	TPS100724	2 1/8	TPS100723	TPS100722	1 1/2	\$ 193.00	HDL000019	4	\$ 11.00	\$ 397.00
1 1/8-12 UNF	TPS100727	TPS100726	1 1/2	TPS100731	TPS100730	1 1/2	\$ 193.00	HDL000019	4	\$ 11.00	\$ 397.00
1 1/8-18 UNEF	TPS100729	TPS100728	1 1/2	TPS100733	TPS100732	1 1/2	\$ 193.00	HDL000019	4	\$ 11.00	\$ 397.00
1 3/16-12 UN	TPS100737	TPS100736	1 5/8	TPS100735	TPS100734	1 1/2	\$ 207.00	HDL000019	4	\$ 11.00	\$ 425.00
1 3/16-18 UNEF	TPS100739	TPS100738	1 5/8	TPS100741	TPS100740	1 5/8	\$ 207.00	HDL000024	5	\$ 12.00	\$ 426.00
1 1/4-7 UNC	TPS100745	TPS100744	2 3/8	TPS100743	TPS100742	1 5/8	\$ 207.00	HDL000024	5	\$ 12.00	\$ 426.00
1 1/4-12 UNF	TPS100747	TPS100746	1 5/8	TPS100745	TPS100744	1 5/8	\$ 213.00	HDL000024	5	\$ 12.00	\$ 438.00
1 1/4-18 UNEF	TPS100749	TPS100748	1 5/8	TPS100751	TPS100750	1 5/8	\$ 213.00	HDL000024	5	\$ 12.00	\$ 438.00
1 5/16-12 UN	TPS100757	TPS100756	1 5/8	TPS100753	TPS100752	1 5/8	\$ 213.00	HDL000024	5	\$ 12.00	\$ 438.00
1 5/16-18 UNEF	TPS100759	TPS100758	1 5/8	TPS100755	TPS100754	1 5/8	\$ 240.00	HDL000024	5	\$ 12.00	\$ 492.00
1 3/8-6 UNC	TPS100765	TPS100764	2 3/8	TPS100757	TPS100756	1 5/8	\$ 243.00	HDL000024	5	\$ 12.00	\$ 498.00
1 3/8-12 UNF	TPS100767	TPS100766	1 5/8	TPS100761	TPS100760	1 5/8	\$ 243.00	HDL000024	5	\$ 12.00	\$ 498.00
1 3/8-18 UNEF	TPS100769	TPS100768	1 5/8	TPS100763	TPS100762	1 5/8	\$ 243.00	HDL000024	5	\$ 12.00	\$ 498.00
1 7/16-12 UN	TPS100777	TPS100776	1 5/8	TPS100771	TPS100770	1 5/8	\$ 245.00	HDL000024	5	\$ 12.00	\$ 502.00
1 7/16-18 UNEF	TPS100779	TPS100778	1 5/8	TPS100773	TPS100772	1 5/8	\$ 245.00	HDL000024	5	\$ 12.00	\$ 502.00
1 1/2-6 UNC	TPS100785	TPS100784	2 3/8	TPS100775	TPS100774	1 5/8	\$ 253.00	HDL000024	5	\$ 12.00	\$ 518.00
1 1/2-12 UNF	TPS100787	TPS100786	1 5/8	TPS100781	TPS100780	1 5/8	\$ 259.00	HDL000024	5	\$ 12.00	\$ 530.00
1 1/2-18 UNEF	TPS100789	TPS100788	1 5/8	TPS100783	TPS100782	1 5/8	\$ 259.00	HDL000024	5	\$ 12.00	\$ 530.00
1 5/8-12 UN	TPS100797	TPS100796	1 7/8	TPS100785	TPS100784	1 5/8	\$ 262.00	HDL000024	5	\$ 12.00	\$ 536.00
1 3/4-12 UN	TPS100803	TPS100802	1 7/8	TPS100793	TPS100792	1 5/8	\$ 262.00	HDL000024	5	\$ 12.00	\$ 536.00
1 7/8-12 UN	TPS100807	TPS100806	1 7/8	TPS100795	TPS100794	1 5/8	\$ 271.00	HDL000024	5	\$ 12.00	\$ 554.00
2-12 UN	TPS100811	TPS100810	1 7/8	TPS100797	TPS100796	1 7/8	\$ 279.00	HDL000023	5	\$ 16.00	\$ 574.00
2 1/4-12 UN	TPS100815	TPS100814	2"	TPS100805	TPS100804	1 7/8	\$ 286.00	HDL000023	5	\$ 16.00	\$ 588.00
2 1/2-12 UN	TPS100819	TPS100818	2"	TPS100809	TPS100808	1 7/8	\$ 307.00	HDL000023	5	\$ 16.00	\$ 630.00
				TPS100813	TPS100812	1 7/8	\$ 316.00	HDL000028	5	\$ 16.00	\$ 648.00
				TPS100817	TPS100816	2"	\$ 348.00	HDL000028	5	\$ 16.00	\$ 712.00
				TPS100824	TPS100820	2"	\$ 392.00	HDL000028	5	\$ 16.00	\$ 800.00

TAPERED PIPE THREAD GAGES

NPT - WORKING GAGES						
Size	L-1 Ring Gage Basic Step		L-1 Plug Gage Basic Step		Handle	
	EDP #	Price	EDP #	Price	EDP #	Price
1/16-27	PRL100001	\$ 180.00	PPL100002	\$ 93.00	HDL000004	1 \$ 10.00
1/8-27	PRL100002	\$ 137.00	PPL100005	\$ 73.00	HDL000009	2 \$ 10.00
1/4-18	PRL100003	\$ 137.00	PPL100008	\$ 76.00	HDL000014	3 \$ 10.00
3/8-18	PRL100004	\$ 147.00	PPL100011	\$ 84.00	HDL000014	3 \$ 10.00
1/2-14	PRL100005	\$ 164.00	PPL100014	\$ 95.00	HDL000019	4 \$ 11.00
3/4-14	PRL100006	\$ 186.00	PPL100017	\$ 109.00	HDL000019	4 \$ 11.00
1-11 1/2	PRL100007	\$ 212.00	PPL100020	\$ 120.00	HDL000024	5 \$ 12.00
1 1/4-11 1/2	PRL100008	\$ 234.00	PPL100023	\$ 135.00	HDL000024	5 \$ 12.00
1 1/2-11 1/2	PRL100009	\$ 277.00	PPL100026	\$ 152.00	HDL000024	5 \$ 12.00
2-11 1/2	PRL100010	\$ 330.00	PPL100029	\$ 186.00	HDL000024	5 \$ 12.00
2 1/2-8	PRL100011	\$ 388.00	PPL100032	\$ 223.00	HDL000027	6 SE \$ 16.00
3-8	PRL100012	\$ 488.00	PPL100035	\$ 259.00	HDL000027	6 SE \$ 16.00
3 1/2-8	PRL100013	\$ 666.00	PPL100037	\$ 388.00	HDL000031	7 SE \$ 17.00
4-8	PRL100014	\$ 761.00	PPL100038	\$ 432.00	HDL000031	7 SE \$ 17.00
5-8	PRL100015	\$ 920.00	PPL100039	\$ 603.00	HDL000031	7 SE \$ 17.00
6-8	PRL100016	\$1,085.00	PPL100040	\$ 718.00	HDL000031	7 SE \$ 17.00

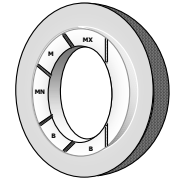
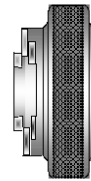
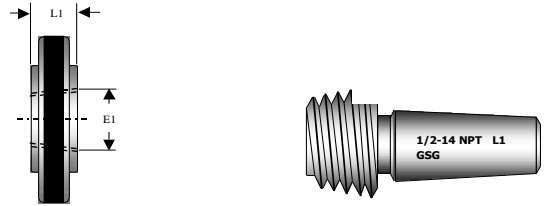

NPT, NPTF & ANPT Plugs supplied with one step.
Additional steps priced on application.

Masters priced on application.

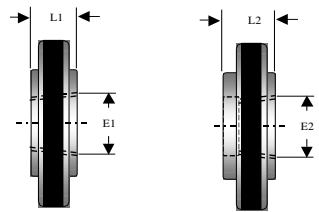

6 STEP RING



TAPER PIPE THREADS - NPTF - WORKING GAGES														
Size	L-1 Ring Gage Basic Step		L-2 Ring Gage Basic Step		Plain Taper Ring 6 Step		L-1 Plug Gage Basic Step		L-3 Plug Gage Basic Step		Plain Taper Plug 6 Step		Handle	
	EDP #	Price	EDP #	Price	EDP #	Price	EDP #	Price	EDP #	Price	EDP #	Price	EDP #	Price
1/16-27	PRL100017	\$ 189.00	PRL200001	\$ 264.00	PR6000001	\$ 321.00	PPL100003	\$ 118.00	PPL300002	\$ 124.00	PP6000002	\$ 202.00	HDL000004	1 \$ 10.00
1/8-27	PRL100018	\$ 164.00	PRL200002	\$ 246.00	PR6000002	\$ 321.00	PPL100006	\$ 95.00	PPL300004	\$ 100.00	PP6000004	\$ 202.00	HDL000009	2 \$ 10.00
1/4-18	PRL100019	\$ 158.00	PRL200003	\$ 264.00	PR6000003	\$ 321.00	PPL100009	\$ 99.00	PPL300006	\$ 104.00	PP6000006	\$ 202.00	HDL000014	3 \$ 10.00
3/8-18	PRL100020	\$ 154.00	PRL200004	\$ 258.00	PR6000004	\$ 321.00	PPL100012	\$ 118.00	PPL300008	\$ 126.00	PP6000008	\$ 202.00	HDL000014	3 \$ 10.00
1/2-14	PRL100021	\$ 173.00	PRL200005	\$ 268.00	PR6000005	\$ 321.00	PPL100015	\$ 136.00	PPL300010	\$ 140.00	PP6000010	\$ 202.00	HDL000019	4 \$ 11.00
3/4-14	PRL100022	\$ 190.00	PRL200006	\$ 297.00	PR6000006	\$ 359.00	PPL100018	\$ 149.00	PPL300012	\$ 158.00	PP6000012	\$ 215.00	HDL000019	4 \$ 11.00
1-11 1/2	PRL100023	\$ 223.00	PRL200007	\$ 324.00	PR6000007	\$ 359.00	PPL100021	\$ 165.00	PPL300014	\$ 174.00	PP6000014	\$ 232.00	HDL000024	5 \$ 12.00
1 1/4-11 1/2	PRL100024	\$ 237.00	PRL200008	\$ 351.00	PR6000008	\$ 392.00	PPL100024	\$ 185.00	PPL300016	\$ 185.00	PP6000016	\$ 247.00	HDL000024	5 \$ 12.00
1 1/2-11 1/2	PRL100025	\$ 285.00	PRL200009	\$ 385.00	PR6000009	\$ 451.00	PPL100027	\$ 210.00	PPL300018	\$ 210.00	PP6000018	\$ 271.00	HDL000024	5 \$ 12.00
2-11 1/2	PRL100026	\$ 403.00	PRL200010	\$ 445.00	PR6000010	\$ 502.00	PPL100030	\$ 250.00	PPL300020	\$ 250.00	PP6000020	\$ 376.00	HDL000024	5 \$ 12.00
2 1/2-8	PRL100027	\$ 438.00	PRL200011	\$ 533.00	PR6000011	\$ 594.00	PPL100033	\$ 393.00	PPL300022	\$ 393.00	PP6000022	\$ 576.00	HDL000027	6 SE \$ 16.00
3-8	PRL100028	\$ 498.00	PRL200012	\$ 630.00	PR6000012	\$ 731.00	PPL100036	\$ 445.00	PPL300024	\$ 445.00	PP6000024	\$ 624.00	HDL000027	6 SE \$ 16.00

ANPT														
Size	L-1 Ring Gage Basic Step		L-2 Ring Gage Basic Step		Plain Taper Ring 6 Step		L-1 Plug Gage Basic Step		L-3 Plug Gage Basic Step		Plain Taper Plug 6 Step		Handle	
	EDP #	Price	EDP #	Price	EDP #	Price	EDP #	Price	EDP #	Price	EDP #	Price	EDP #	Price
1/16-27	PRL100029	\$ 255.00	PRL200013	\$ 299.00	PR6000013	\$ 338.00	PPL100001	\$ 174.00	PPL300001	\$ 212.00	PP6000001	\$ 214.00	HDL000004	1 \$ 10.00
1/8-27	PRL100030	\$ 223.00	PRL200014	\$ 271.00	PR6000014	\$ 338.00	PPL100004	\$ 174.00	PPL300003	\$ 162.00	PP6000003	\$ 214.00	HDL000009	2 \$ 10.00
1/4-18	PRL100031	\$ 217.00	PRL200015	\$ 280.00	PR6000015	\$ 338.00	PPL100007	\$ 174.00	PPL300005	\$ 162.00	PP6000005	\$ 214.00	HDL000014	3 \$ 10.00
3/8-18	PRL100032	\$ 217.00	PRL200016	\$ 273.00	PR6000016	\$ 338.00	PPL100010	\$ 162.00	PPL300007	\$ 162.00	PP6000007	\$ 214.00	HDL000014	3 \$ 10.00
1/2-14	PRL100033	\$ 196.00	PRL200017	\$ 284.00	PR6000017	\$ 338.00	PPL100013	\$ 149.00	PPL300009	\$ 174.00	PP6000009	\$ 214.00	HDL000019	4 \$ 11.00
3/4-14	PRL100034	\$ 212.00	PRL200018	\$ 312.00	PR6000018	\$ 378.00	PPL100016	\$ 158.00	PPL300011	\$ 174.00	PP6000011	\$ 225.00	HDL000019	4 \$ 11.00
1-11 1/2	PRL100035	\$ 274.00	PRL200019	\$ 340.00	PR6000019	\$ 378.00	PPL100019	\$ 180.00	PPL300013	\$ 212.00	PP6000013	\$ 246.00	HDL000024	5 \$ 12.00
1 1/4-11 1/2	PRL100036	\$ 274.00	PRL200020	\$ 367.00	PR6000020	\$ 413.00	PPL100022	\$ 187.00	PPL300015	\$ 212.00	PP6000015	\$ 260.00	HDL000024	5 \$ 12.00
1 1/2-11 1/2	PRL100037	\$ 299.00	PRL200021	\$ 403.00	PR6000021	\$ 472.00	PPL100025	\$ 210.00	PPL300017	\$ 212.00	PP6000017	\$ 282.00	HDL000024	5 \$ 12.00
2-11 1/2	PRL100038	\$ 423.00	PRL200022	\$ 467.00	PR6000022	\$ 529.00	PPL100028	\$ 250.00	PPL300019	\$ 250.00	PP6000019	\$ 393.00	HDL000024	5 \$ 12.00
2 1/2-8	PRL100039	\$ 460.00	PRL200023	\$ 559.00	PR6000023	\$ 626.00	PPL100031	\$ 393.00	PPL300021	\$ 393.00	PP6000021	\$ 605.00	HDL000027	6 SE \$ 16.00
3-8	PRL100040	\$ 524.00	PRL200024	\$ 663.00	PR6000024	\$ 765.00	PPL100034	\$ 445.00	PPL300023	\$ 445.00	PP6000023	\$ 656.00	HDL000027	6 SE \$ 16.00

BRITISH STANDARD PIPE THREAD GAGES

IN STOCK AS CLASS B, CONTACT FACTORY FOR CLASS A

GO PLUGS 1/8 AND SMALLER ARE TRUNCATED, ABOVE ARE FULL FORM - NOGO PLUGS ARE ALL TRUNCATED
GO RINGS 3/8 AND SMALLER ARE TRUNCATED, ABOVE ARE FULL FORM - NOGO RINGS ARE ALL TRUNCATED

BSPP THREAD GAGES													
		BSPP Plug Gage ISO 228-2 (Obsolete BS2779)				BSPP Truncated Set Plugs ISO 228-2 (Obsolete BS2779)		BSPP Progressive Check Plug ISO 228-2 (Obsolete BS2779)		BSPP Adjustable Ring Gage ISO 228-2 (Obsolete BS2779)		BSPP Solid Ring Gage ISO 228-2 (Obsolete BS2779)	
Size	TPI	EDP #	Price	Handle	Price	EDP#	Price	EDP#	Price	EDP #	Price	EDP #	Price
G1/8 GO	28	BSP200001	\$ 88.00	HDL000009	\$ 10.00	BSP200056	\$ 132.00	BSP200211	\$ 198.00	BSP300001	\$ 150.00	BSP300056	\$ 195.00
G1/8 NOGO	28	BSP200002	\$ 88.00	HDL000009	\$ 10.00	BSP200057	\$ 132.00	BSP200212	\$ 198.00	BSP300002	\$ 137.00	BSP300057	\$ 178.00
G1/4 GO	19	BSP200003	\$ 100.00	HDL000014	\$ 10.00	BSP200058	\$ 150.00	BSP200213	\$ 225.00	BSP300003	\$ 173.00	BSP300058	\$ 225.00
G1/4 NOGO	19	BSP200004	\$ 100.00	HDL000014	\$ 10.00	BSP200059	\$ 150.00	BSP200214	\$ 225.00	BSP300004	\$ 155.00	BSP300059	\$ 202.00
G3/8 GO	19	BSP200005	\$ 102.00	HDL000014	\$ 10.00	BSP200060	\$ 153.00	BSP200215	\$ 230.00	BSP300005	\$ 200.00	BSP300060	\$ 261.00
G3/8 NOGO	19	BSP200006	\$ 102.00	HDL000014	\$ 10.00	BSP200061	\$ 153.00	BSP200216	\$ 230.00	BSP300006	\$ 180.00	BSP300061	\$ 235.00
G1/2 GO	14	BSP200007	\$ 108.00	HDL000019	\$ 11.00	BSP200062	\$ 161.00	BSP200217	\$ 242.00	BSP300007	\$ 229.00	BSP300062	\$ 298.00
G1/2 NOGO	14	BSP200008	\$ 108.00	HDL000019	\$ 11.00	BSP200063	\$ 161.00	BSP200218	\$ 242.00	BSP300008	\$ 207.00	BSP300063	\$ 268.00
G5/8 GO	14	BSP200009	\$ 116.00	HDL000019	\$ 11.00	BSP200064	\$ 174.00	BSP200219	\$ 262.00	BSP300009	\$ 244.00	BSP300064	\$ 317.00
G5/8 NOGO	14	BSP200010	\$ 116.00	HDL000019	\$ 11.00	BSP200065	\$ 174.00	BSP200220	\$ 262.00	BSP300010	\$ 220.00	BSP300065	\$ 285.00
G3/4 GO	14	BSP200011	\$ 120.00	HDL000019	\$ 11.00	BSP200066	\$ 179.00	BSP200221	\$ 269.00	BSP300011	\$ 263.00	BSP300066	\$ 342.00
G3/4 NOGO	14	BSP200012	\$ 120.00	HDL000019	\$ 11.00	BSP200067	\$ 179.00	BSP200222	\$ 269.00	BSP300012	\$ 237.00	BSP300067	\$ 308.00
G7/8 GO	14	BSP200013	\$ 128.00	HDL000024	\$ 12.00	BSP200068	\$ 192.00	BSP200223	\$ 289.00	BSP300013	\$ 290.00	BSP300068	\$ 377.00
G7/8 NOGO	14	BSP200014	\$ 128.00	HDL000024	\$ 12.00	BSP200069	\$ 192.00	BSP200224	\$ 289.00	BSP300014	\$ 261.00	BSP300069	\$ 339.00
G1 GO	11	BSP200015	\$ 135.00	HDL000024	\$ 12.00	BSP200070	\$ 202.00	BSP200225	\$ 303.00	BSP300015	\$ 315.00	BSP300070	\$ 410.00
G1 NOGO	11	BSP200016	\$ 135.00	HDL000024	\$ 12.00	BSP200071	\$ 202.00	BSP200226	\$ 303.00	BSP300016	\$ 284.00	BSP300071	\$ 369.00
G1-1/8 GO	11	BSP200017	\$ 158.00	HDL000024	\$ 12.00	BSP200072	\$ 236.00	BSP200227	\$ 355.00	BSP300017	\$ 351.00	BSP300072	\$ 457.00
G1-1/8 NOGO	11	BSP200018	\$ 158.00	HDL000024	\$ 12.00	BSP200073	\$ 236.00	BSP200228	\$ 355.00	BSP300018	\$ 316.00	BSP300073	\$ 411.00
G1-1/4 GO	11	BSP200019	\$ 158.00	HDL000032	\$ 17.00	BSP200074	\$ 236.00	BSP200229	\$ 355.00	BSP300019	\$ 374.00	BSP300074	\$ 487.00
G1-1/4 NOGO	11	BSP200020	\$ 158.00	HDL000032	\$ 17.00	BSP200075	\$ 236.00	BSP200230	\$ 355.00	BSP300020	\$ 337.00	BSP300075	\$ 438.00
G1-1/2 GO	11	BSP200021	\$ 166.00	HDL000032	\$ 17.00	BSP200076	\$ 249.00	BSP200231	\$ 374.00	BSP300021	\$ 384.00	BSP300076	\$ 499.00
G1-1/2 NOGO	11	BSP200022	\$ 166.00	HDL000032	\$ 17.00	BSP200077	\$ 249.00	BSP200232	\$ 374.00	BSP300022	\$ 346.00	BSP300077	\$ 449.00
G1-3/4 GO	11	BSP200023	\$ 177.00	HDL000032	\$ 17.00	BSP200078	\$ 266.00	BSP200233	\$ 399.00	BSP300023	\$ 409.00	BSP300078	\$ 532.00
G1-3/4 NOGO	11	BSP200024	\$ 177.00	HDL000032	\$ 17.00	BSP200079	\$ 266.00	BSP200234	\$ 399.00	BSP300024	\$ 386.00	BSP300079	\$ 502.00
G2 GO	11	BSP200025	\$ 190.00	HDL000032	\$ 17.00	BSP200080	\$ 285.00	BSP200235	\$ 428.00	BSP300025	\$ 449.00	BSP300080	\$ 584.00
G2 NOGO	11	BSP200026	\$ 190.00	HDL000032	\$ 17.00	BSP200081	\$ 285.00	BSP200236	\$ 428.00	BSP300026	\$ 404.00	BSP300081	\$ 526.00
G2-1/4 GO	11	BSP200027	\$ 260.00	HDL000032	\$ 17.00	BSP200082	\$ 390.00	BSP200237	\$ 585.00	BSP300027	\$ 624.00	BSP300082	\$ 812.00
G2-1/4 NOGO	11	BSP200028	\$ 260.00	HDL000032	\$ 17.00	BSP200083	\$ 390.00	BSP200238	\$ 585.00	BSP300028	\$ 562.00	BSP300083	\$ 731.00
G2-1/2 GO	11	BSP200029	\$ 260.00	HDL000032	\$ 17.00	BSP200084	\$ 390.00	BSP200239	\$ 585.00	BSP300029	\$ 624.00	BSP300084	\$ 812.00
G2-1/2 NOGO	11	BSP200030	\$ 260.00	HDL000032	\$ 17.00	BSP200085	\$ 390.00	BSP200240	\$ 585.00	BSP300030	\$ 562.00	BSP300085	\$ 731.00
G3 GO	11	BSP200031	\$ 311.00	HDL000032	\$ 17.00	BSP200086	\$ 466.00	BSP200241	\$ 699.00	BSP300031	\$ 725.00	BSP300086	\$ 942.00
G3 NOGO	11	BSP200032	\$ 311.00	HDL000032	\$ 17.00	BSP200087	\$ 466.00	BSP200242	\$ 699.00	BSP300032	\$ 652.00	BSP300087	\$ 848.00
G3-1/2 GO	11	BSP200033	\$ 349.00	HDL000032	\$ 17.00	BSP200088	\$ 523.00	BSP200243	\$ 785.00	BSP300033	\$ 836.00	BSP300088	\$ 1,086.00
G3-1/2 NOGO	11	BSP200034	\$ 349.00	HDL000032	\$ 17.00	BSP200089	\$ 523.00	BSP200244	\$ 785.00	BSP300034	\$ 752.00	BSP300089	\$ 978.00
G4 GO	11	BSP200035	\$ 427.00	HDL000032	\$ 17.00	BSP200090	\$ 641.00	BSP200245	\$ 961.00	BSP300035	\$ 971.00	BSP300090	\$ 1,262.00
G4 NOGO	11	BSP200036	\$ 427.00	HDL000032	\$ 17.00	BSP200091	\$ 641.00	BSP200246	\$ 961.00	BSP300036	\$ 874.00	BSP300091	\$ 1,136.00
G5 GO	11	BSP200037	\$ 582.00	HDL000032	\$ 17.00	BSP200092	\$ 872.00	BSP200247	\$ 1,308.00	BSP300037	\$ 1,287.00	BSP300092	\$ 1,674.00
G5 NOGO	11	BSP200038	\$ 582.00	HDL000032	\$ 17.00	BSP200093	\$ 872.00	BSP200248	\$ 1,308.00	BSP300038	\$ 1,159.00	BSP300093	\$ 1,506.00
G6 GO	11	BSP200039	\$ 645.00	HDL000032	\$ 17.00	BSP200094	\$ 967.00	BSP200249	\$ 1,450.00	BSP300039	\$ 1,603.00	BSP300094	\$ 2,083.00
G6 NOGO	11	BSP200040	\$ 645.00	HDL000032	\$ 17.00	BSP200095	\$ 967.00	BSP200250	\$ 1,450.00	BSP300040	\$ 1,442.00	BSP300095	\$ 1,875.00

IN STOCK AS SYSTEM B, CONTACT FACTORY FOR SYSTEM A
PLUGS 1/8 AND SMALLER ARE TRUNCATED, ABOVE ARE FULL FORM
RINGS 3/8 AND SMALLER ARE TRUNCATED, ABOVE ARE FULL FORM

BSPT THREAD GAGES							
		BSPT Plug Gage BS21				BSPT Solid Ring Gage BS21	
Size	TPI	EDP #	Price	Handle	Price	EDP #	Price
1/16	28	BSP200041	\$ 200.00	HDL000004	\$ 10.00	BSP300096	\$ 450.00
1/8	28	BSP200042	\$ 173.00	HDL000009	\$ 10.00	BSP300097	\$ 389.00
1/4	19	BSP200043	\$ 173.00	HDL000014	\$ 10.00	BSP300098	\$ 389.00
3/8	19	BSP200044	\$ 173.00	HDL000014	\$ 10.00	BSP300099	\$ 389.00
1/2	14	BSP200045	\$ 185.00	HDL000019	\$ 11.00	BSP300100	\$ 416.00
3/4	14	BSP200046	\$ 198.00	HDL000019	\$ 11.00	BSP300101	\$ 445.00
1	11	BSP200047	\$ 208.00	HDL000024	\$ 12.00	BSP300102	\$ 467.00
1 1/4	11	BSP200048	\$ 225.00	HDL000024	\$ 12.00	BSP300103	\$ 506.00
1 1/2	11	BSP200049	\$ 237.00	HDL000024	\$ 12.00	BSP300104	\$ 533.00
2	11	BSP200050	\$ 264.00	HDL000024	\$ 12.00	BSP300105	\$ 594.00
2 1/2	11	BSP200051	\$ 298.00	HDL000032	\$ 17.00	BSP300106	\$ 670.00
3.0	11	BSP200052	\$ 495.00	HDL000032	\$ 17.00	BSP300107	\$ 1,113.00
4	11	BSP200053	\$ 818.00	HDL000032	\$ 17.00	BSP300108	\$ 1,842.00
5	11	BSP200054	\$ 1,025.00	HDL000032	\$ 17.00	BSP300109	\$ 2,306.00
6	11	BSP200055	\$ 1,147.00	HDL000032	\$ 17.00	BSP300110	\$ 2,580.00

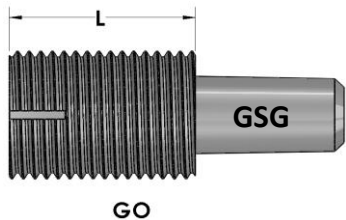

**HELICAL COIL (STI)
THREAD PLUG GAGES
STEEL**

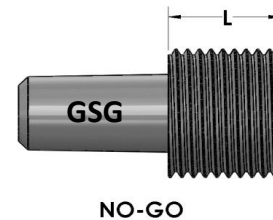

GO

NO-GO

Helical Coil (STI) Plug Gages are used to gage threaded holes prior to insertion of screw thread inserts. Screw thread inserts are used to repair a damaged thread or to provide a stronger threaded assembly. All Helical Coil Plug Gages are manufactured of oil hardened tool steel to class X tolerance. For Class W contact factory.

Nominal Size	Go BASIC 2B or 3B EDP #	Go Length "L"	Inch			Member List Price	Handle EDP #	Handle #	Handle Price	Double End Go/NoGo/Hdle List Price
			NoGo Class 2B EDP #	NoGo Class 3B EDP #	NoGo Length "L"					
2-56 (.086) UNC	TPS100384	5/16	TPS100383	TPS100382	7/32	\$ 57.00	HDL000002	00	\$ 11.00	\$ 125.00
3-48 (.099) UNC	TPS100390	5/16	TPS100388	TPS100387	7/32	\$ 54.00	HDL000002	00	\$ 11.00	\$ 119.00
3-56 (.099) UNF	TPS100389	5/16	TPS100385	TPS100386	7/32	\$ 54.00	HDL000002	00	\$ 11.00	\$ 119.00
4-40 (.112) UNC	TPS100396	5/16	TPS100394	TPS100393	7/32	\$ 51.00	HDL000002	00	\$ 11.00	\$ 113.00
4-48 (.112) UNF	TPS100395	5/16	TPS100392	TPS100391	7/32	\$ 51.00	HDL000002	00	\$ 11.00	\$ 113.00
5-40 (.125) UNC	TPS100399	13/32	TPS100398	TPS100397	9/32	\$ 51.00	HDL000003	0	\$ 11.00	\$ 113.00
6-32 (.138) UNC	TPS100405	13/32	TPS100403	TPS100402	9/32	\$ 51.00	HDL000003	0	\$ 11.00	\$ 113.00
6-40 (.138) UNF	TPS100404	13/32	TPS100401	TPS100400	9/32	\$ 51.00	HDL000003	0	\$ 11.00	\$ 113.00
8-32 (.164) UNC	TPS100411	13/32	TPS100409	TPS100408	9/32	\$ 49.00	HDL000003	0	\$ 11.00	\$ 109.00
8-36 (.164) UNF	TPS100410	13/32	TPS100407	TPS100406	9/32	\$ 49.00	HDL000003	0	\$ 11.00	\$ 109.00
10-24 (.190) UNC	TPS100417	1/2	TPS100415	TPS100414	5/16	\$ 49.00	HDL000003	0	\$ 11.00	\$ 109.00
10-32 (.190) UNF	TPS100416	1/2	TPS100413	TPS100412	5/16	\$ 49.00	HDL000003	0	\$ 11.00	\$ 109.00
12-24 (.216) UNC	TPS100420	1/2	TPS100419	TPS100418	5/16	\$ 49.00	HDL000004	1	\$ 10.00	\$ 108.00
1/4-20 UNC	TPS100426	1/2	TPS100424	TPS100423	5/16	\$ 47.00	HDL000004	1	\$ 10.00	\$ 104.00
1/4-28 UNF	TPS100425	1/2	TPS100422	TPS100421	5/16	\$ 47.00	HDL000004	1	\$ 10.00	\$ 104.00
5/16-18 UNC	TPS100432	3/4	TPS100430	TPS100429	3/8	\$ 47.00	HDL000009	2	\$ 10.00	\$ 104.00
5/16-24 UNF	TPS100431	3/4	TPS100428	TPS100427	3/8	\$ 47.00	HDL000009	2	\$ 10.00	\$ 104.00
3/8-16 UNC	TPS100438	3/4	TPS100437	TPS100436	3/8	\$ 49.00	HDL000009	2	\$ 10.00	\$ 108.00
3/8-24 UNF	TPS100435	3/4	TPS100434	TPS100433	3/8	\$ 49.00	HDL000009	2	\$ 10.00	\$ 108.00
7/16-14 UNC	TPS100444	7/8	TPS100440	TPS100442	1/2	\$ 51.00	HDL000014	3	\$ 10.00	\$ 112.00
7/16-20 UNF	TPS100441	7/8	TPS100443	TPS100439	1/2	\$ 51.00	HDL000014	3	\$ 10.00	\$ 112.00
1/2-13 UNC	TPS100450	7/8	TPS100449	TPS100448	1/2	\$ 54.00	HDL000014	3	\$ 10.00	\$ 118.00
1/2-20 UNF	TPS100447	7/8	TPS100446	TPS100445	1/2	\$ 54.00	HDL000014	3	\$ 10.00	\$ 118.00
9/16-12 UNC	TPS100456	7/8	TPS100455	TPS100454	1/2	\$ 62.00	HDL000014	3	\$ 10.00	\$ 134.00
9/16-18 UNF	TPS100453	7/8	TPS100452	TPS100451	1/2	\$ 62.00	HDL000014	3	\$ 10.00	\$ 134.00
5/8-11 UNC	TPS100462	7/8	TPS100461	TPS100460	1/2	\$ 62.00	HDL000014	3	\$ 10.00	\$ 134.00
5/8-18 UNF	TPS100459	7/8	TPS100458	TPS100457	1/2	\$ 62.00	HDL000014	3	\$ 10.00	\$ 134.00
3/4-10 UNC	TPS100468	1	TPS100467	TPS100466	5/8	\$ 66.00	HDL000019	4	\$ 11.00	\$ 143.00
3/4-16 UNF	TPS100465	1	TPS100464	TPS100463	5/8	\$ 66.00	HDL000014	3	\$ 10.00	\$ 142.00

HOLE LOCATING PLUGS

The Centerline Flex Plug is used to measure location of a tapped hole in a product part typically with a CMM. Note: Sizes #10 / M5 and smaller are solid with a tapered thread size from high to low limit (class 2B / 6H).



FLEX PLUGS - INCH										
Size	EDP #	Price		Size	EDP #	Price		Size	EDP #	Price
0-80	FP1000001	\$ 134.00		8-32	FP1000014	\$ 105.00		7/16-20	FP1000027	\$ 99.00
1-64	FP1000002	\$ 128.00		8-36	FP1000015	\$ 110.00		1/2-13	FP1000028	\$ 101.00
1-72	FP1000003	\$ 132.00		10-24	FP1000016	\$ 104.00		1/2-20	FP1000029	\$ 104.00
2-56	FP1000004	\$ 124.00		10-32	FP1000017	\$ 105.00		9/16-12	FP1000030	\$ 99.00
2-64	FP1000005	\$ 128.00		12-24	FP1000018	\$ 103.00		9/16-18	FP1000031	\$ 104.00
3-48	FP1000006	\$ 118.00		12-28	FP1000019	\$ 104.00		5/8-11	FP1000032	\$ 103.00
3-56	FP1000007	\$ 124.00		1/4-20	FP1000020	\$ 89.00		5/8-18	FP1000033	\$ 108.00
4-40	FP1000008	\$ 103.00		1/4-28	FP1000021	\$ 90.00		3/4-10	FP1000034	\$ 108.00
4-48	FP1000009	\$ 109.00		5/16-18	FP1000022	\$ 89.00		3/4-16	FP1000035	\$ 110.00
5-40	FP1000010	\$ 110.00		5/16-24	FP1000023	\$ 90.00		7/8-9	FP1000037	\$ 126.00
5-44	FP1000011	\$ 104.00		3/8-16	FP1000024	\$ 98.00		7/8-14	FP1000036	\$ 132.00
6-32	FP1000012	\$ 111.00		3/8-24	FP1000025	\$ 99.00		1"-8	FP1000039	\$ 179.00
6-40	FP1000013	\$ 113.00		7/16-14	FP1000026	\$ 95.00		1"-12	FP1000038	\$ 179.00

FLEX PLUG - METRIC										
Size	EDP #	Price		Size	EDP #	Price		Size	EDP #	Price
M1.6 x 0.35	FP2000001	\$ 146.00		M10 x 1.25	FP2000012	\$ 113.00		M17 x 1.0	FP2000023	\$ 134.00
M2 x 0.4	FP2000002	\$ 140.00		M10 x 0.75	FP2000013	\$ 152.00		M18 x 1.5	FP2000024	\$ 134.00
M2.5 x 0.45	FP2000003	\$ 140.00		M12 x 1.75	FP2000014	\$ 118.00		M20 x 2.5	FP2000025	\$ 134.00
M3 x 0.5	FP2000004	\$ 136.00		M12 x 1.5	FP2000015	\$ 118.00		M20 x 1.5	FP2000026	\$ 136.00
M3.5 x .6	FP2000005	\$ 136.00		M12 x 1.25	FP2000016	\$ 122.00		M20 x 1.0	FP2000027	\$ 136.00
M4 x 0.7	FP2000006	\$ 132.00		M12 x 1.0	FP2000017	\$ 122.00		M22 x 2.5	FP2000028	\$ 149.00
M5 x 0.8	FP2000007	\$ 122.00		M14 x 2.0	FP2000018	\$ 126.00		M22 x 1.5	FP2000029	\$ 149.00
M6 x 1.0	FP2000008	\$ 109.00		M14 x 1.5	FP2000019	\$ 126.00		M24 x 3.0	FP2000030	\$ 162.00
M8 x 1.25	FP2000009	\$ 108.00		M15 x 1.0	FP2000020	\$ 126.00		M24 x 2.0	FP2000031	\$ 162.00
M8 x 1.0	FP2000010	\$ 108.00		M16 x 2.0	FP2000021	\$ 126.00		NA	NA	NA
M10 x 1.5	FP2000011	\$ 112.00		M16 x 1.5	FP2000022	\$ 132.00		NA	NA	NA

AGD LIMIT SNAP GAGES



Gaging surfaces are hardened, ground & lapped tool steel.
Marking discs are supplied on all snap gages.

Set & Sealed \$ 45.00
Unset but Marked \$ 15.00

MODEL "C" STYLE 108			
FRAME #	RANGE	EDP #	Price
1	0 - 1/4	SN0000001	\$ 153.00
2	1/4 - 1/2	SN0000002	\$ 155.00
2X	1/2 - 3/4	SN0000003	\$ 155.00
3	3/4 - 1	SN0000004	\$ 163.00
3X	1 - 1 1/4	SN0000005	\$ 163.00
4	1 1/4 - 1 1/2	SN0000006	\$ 166.00
4X	1 1/2 - 1 3/4	SN0000007	\$ 166.00
5	1 3/4 - 2	SN0000008	\$ 172.00
5X	2 - 2 1/4	SN0000009	\$ 172.00
6	2 1/4 - 2 1/2	SN0000010	\$ 180.00
6X	2 1/2 - 2 3/4	SN0000011	\$ 180.00
7	2 3/4 - 3 1/16	SN0000012	\$ 197.00
7X	3 1/16 - 3 7/16	SN0000013	\$ 208.00
8	3 7/16 - 3 13/16	SN0000014	\$ 225.00
8X	3 13/16 - 4 3/16	SN0000015	\$ 225.00
9	4 3/16 - 4 9/16	SN0000016	\$ 257.00
9X	4 9/16 - 4 15/16	SN0000017	\$ 257.00
10	4 15/16 - 5 5/16	SN0000018	\$ 301.00
10X	5 5/16 - 5 11/16	SN0000019	\$ 301.00
11	5 11/16 - 6 1/8	SN0000020	\$ 385.00
11X	6 1/8 - 6 5/8	SN0000021	\$ 385.00
12	6 5/8 - 7 1/8	SN0000022	\$ 439.00
12X	7 1/8 - 7 5/8	SN0000023	\$ 439.00
13	7 5/8 - 8 1/8	SN0000024	\$ 483.00
13X	8 1/8 - 8 5/8	SN0000025	\$ 483.00

MODEL "MC" STYLE 102			
FRAME #	RANGE	EDP #	Price
00	.000 - .195	SN0000026	\$ 164.00
00	.195 - .385	SN0000027	\$ 164.00
0	.385 - .570	SN0000028	\$ 164.00
0	.570 - .760	SN0000029	\$ 164.00



MODEL "A" STYLE 104			
FRAME #	RANGE	EDP #	Price
1	0 - 1/2	SN0000030	\$ 137.00
2	1/2 - 1	SN0000031	\$ 142.00
3	1 - 1 1/2	SN0000032	\$ 149.00
4	1 1/2 - 2	SN0000033	\$ 153.00
5	2 - 2 1/2	SN0000034	\$ 164.00
6	2 1/2 - 3	SN0000035	\$ 172.00
7	3 - 3 3/4	SN0000036	\$ 191.00
8	3 3/4 - 4 1/2	SN0000037	\$ 208.00
9	4 1/2 - 5 1/4	SN0000038	\$ 237.00
10	5 1/4 - 6	SN0000039	\$ 264.00

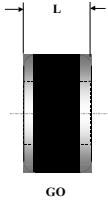

CYLINDRICAL RING GAGES

See page 42 for our new Chamfer Master Rings.

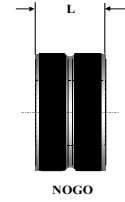

All Cylindrical Ring Gages are manufactured to ASME/ANSI B47.1 AGD standard and ASME/ANSI B89.1.6

CLASS XXX PLEASE CONTACT FACTORY
QUANTITY DISCOUNT 5 OR MORE OF IDENTICAL SIZE LESS 10%

Size	Class	Tolerance	Blank OD / Length	STEEL	CHROME	CARBIDE
				QUANTITY 1		
.015 to .025 0.381mm to 0.635mm	XX	.000020		\$ 324.00		
	X	.000040	#000	\$ 257.00		
	Y	.000070	15/16 3/32	\$ 243.00		
	Z	.0001		\$ 243.00		
.0251 to .040 0.636mm to 1.02mm	XX	.000020		\$ 289.00		
	X	.000040	#000	\$ 239.00		
	Y	.000070	15/16 3/32	\$ 224.00		
	Z	.0001		\$ 224.00		
.0401 to .070 1.021mm to 1.78mm	XX	.000020		\$ 195.00		\$ 292.00
	X	.000040	#00	\$ 160.00		\$ 266.00
	Y	.000070	15/16 3/16	\$ 157.00		\$ 251.00
	Z	.0001		\$ 157.00		\$ 244.00
.0701 to .150 1.781mm to 3.81mm	XX	.000020		\$ 179.00		\$ 280.00
	X	.000040	#00	\$ 148.00		\$ 252.00
	Y	.000070	15/16 3/16	\$ 145.00		\$ 244.00
	Z	.0001		\$ 145.00		\$ 234.00
.1501 to .230 3.811mm to 5.84mm	XX	.000020		\$ 135.00	\$ 174.00	\$ 251.00
	X	.000040	#0	\$ 123.00	\$ 158.00	\$ 231.00
	Y	.000070	15/16 3/8	\$ 115.00	\$ 150.00	\$ 216.00
	Z	.0001		\$ 115.00	\$ 150.00	\$ 208.00
.2301 to .365 5.841mm to 9.27mm	XX	.000020		\$ 117.00	\$ 153.00	\$ 226.00
	X	.000040	#1	\$ 108.00	\$ 138.00	\$ 207.00
	Y	.000070	1 1/8 9/16	\$ 103.00	\$ 134.00	\$ 196.00
	Z	.0001		\$ 103.00	\$ 134.00	\$ 187.00
.3651 to .510 9.271mm to 12.95mm	XX	.000020		\$ 118.00	\$ 154.00	\$ 236.00
	X	.000040	#2	\$ 109.00	\$ 140.00	\$ 214.00
	Y	.000070	1 3/8 3/4	\$ 102.00	\$ 134.00	\$ 205.00
	Z	.0001		\$ 102.00	\$ 134.00	\$ 196.00
.5101 to .825 12.951mm to 20.96mm	XX	.000020		\$ 123.00	\$ 158.00	\$ 278.00
	X	.000040	#3	\$ 111.00	\$ 143.00	\$ 251.00
	Y	.000070	1 3/4 15/16	\$ 107.00	\$ 137.00	\$ 238.00
	Z	.0001		\$ 107.00	\$ 137.00	\$ 231.00
.8251 to 1.135 20.961mm to 28.83mm	XX	.000030		\$ 125.00	\$ 165.00	\$ 384.00
	X	.000060	#4	\$ 114.00	\$ 148.00	\$ 348.00
	Y	.000090	2 1/8 1 1/8	\$ 109.00	\$ 142.00	\$ 329.00
	Z	.00012		\$ 109.00	\$ 142.00	\$ 321.00
1.1351 to 1.335 28.831mm to 33.91mm	XX	.000030		\$ 155.00	\$ 204.00	\$ 459.00
	X	.000060	#5	\$ 130.00	\$ 170.00	\$ 393.00
	Y	.000090	2 1/2 1 5/16	\$ 123.00	\$ 160.00	\$ 369.00
	Z	.00012		\$ 123.00	\$ 160.00	\$ 362.00
1.3351 to 1.510 33.911mm to 38.35mm	XX	.000030		\$ 155.00	\$ 204.00	\$ 494.00
	X	.000060	#5	\$ 130.00	\$ 170.00	\$ 427.00
	Y	.000090	2 1/2 1 5/16	\$ 123.00	\$ 160.00	\$ 398.00
	Z	.00012		\$ 123.00	\$ 160.00	\$ 389.00
1.5101 to 1.760 38.351mm to 44.70mm	XX	.000040		\$ 188.00	\$ 246.00	\$ 635.00
	X	.000080	#6	\$ 173.00	\$ 223.00	\$ 539.00
	Y	.00012	4 1 1/2	\$ 162.00	\$ 212.00	\$ 495.00
	Z	.00016		\$ 162.00	\$ 212.00	\$ 486.00
1.7601 to 2.010 44.701mm to 51.05mm	XX	.000040		\$ 188.00	\$ 246.00	\$ 692.00
	X	.000080	#6	\$ 173.00	\$ 223.00	\$ 632.00
	Y	.00012	4 1 1/2	\$ 162.00	\$ 212.00	\$ 598.00
	Z	.00016		\$ 162.00	\$ 212.00	\$ 588.00
2.0101 to 2.260 51.051mm to 57.40mm	XX	.000040		\$ 233.00	\$ 302.00	\$ 839.00
	X	.000080	#7	\$ 193.00	\$ 251.00	\$ 756.00
	Y	.00012	4 1/2 1 1/2	\$ 176.00	\$ 229.00	\$ 722.00
	Z	.00016		\$ 176.00	\$ 229.00	\$ 715.00
2.2601 to 2.510 57.401mm to 63.75mm	XX	.000040		\$ 233.00	\$ 302.00	\$ 951.00
	X	.000080	#7	\$ 193.00	\$ 251.00	\$ 851.00
	Y	.00012	4 1/2 1 1/2	\$ 176.00	\$ 229.00	\$ 809.00
	Z	.00016		\$ 176.00	\$ 229.00	\$ 800.00

**CYLINDRICAL
RING GAGES
STEEL & CHROME**

See page 42 for our new Chamfer Gage
Rings

Size	Class	Tolerance	Blank OD / Length	QUANTITY 1	
				STEEL	CHROME
2.5101 to 3.010 63.751mm to 76.45mm	XX	.000050	#8 5 1 1/2	\$ 270.00	\$ 349.00
	X	.0001		\$ 226.00	\$ 292.00
	Y	.00015		\$ 201.00	\$ 261.00
	Z	.0002		\$ 201.00	\$ 261.00
3.0101 to 3.510 76.451mm to 89.15mm	XX	.000050	#9 5 1/2 1 1/2	\$ 314.00	\$ 410.00
	X	.0001		\$ 261.00	\$ 340.00
	Y	.00015		\$ 236.00	\$ 307.00
	Z	.0002		\$ 236.00	\$ 307.00
3.5101 to 4.010 89.151mm to 101.85mm	XX	.000050	#10 6 3/8 1 1/2	\$ 360.00	\$ 468.00
	X	.0001		\$ 296.00	\$ 383.00
	Y	.00015		\$ 268.00	\$ 348.00
	Z	.0002		\$ 268.00	\$ 348.00
4.0101 to 4.760 101.851mm to 120.90mm	XX	.000050	#11 7 1/4 1 1/2	\$ 412.00	\$ 534.00
	X	.0001		\$ 343.00	\$ 445.00
	Y	.00015		\$ 307.00	\$ 398.00
	Z	.0002		\$ 307.00	\$ 398.00
4.7601 to 5.510 120.911mm to 139.95mm	XX	.000065	#12 8 1/4 1 1/2	\$ 551.00	\$ 715.00
	X	.00013		\$ 459.00	\$ 596.00
	Y	.00019		\$ 413.00	\$ 536.00
	Z	.00025		\$ 413.00	\$ 536.00
5.5101 to 6.260 139.951mm to 159.00mm	XX	.000065	#13 9 1/4 1 1/2	\$ 627.00	\$ 818.00
	X	.00013		\$ 523.00	\$ 682.00
	Y	.00019		\$ 474.00	\$ 615.00
	Z	.00025		\$ 474.00	\$ 615.00
6.2601 to 7.010 159.001mm to 178.05mm	XX	See chart	#14 10 1/4 1 1/2	\$ 764.00	\$ 998.00
	X			\$ 693.00	\$ 905.00
	Y			\$ 662.00	\$ 861.00
	Z			\$ 662.00	\$ 861.00
7.0101 to 7.760 178.051mm to 197.10mm	XX	.000080	#15 11 1/4 1 1/2	\$ 791.00	\$ 1,030.00
	X	.00016		\$ 717.00	\$ 935.00
	Y	.00024		\$ 686.00	\$ 890.00
	Z	.00032		\$ 686.00	\$ 890.00
7.7601 to 8.510 197.101mm to 216.15mm	XX	.000080	#16 12 1/4 1 1/2	\$ 895.00	\$ 1,166.00
	X	.00016		\$ 810.00	\$ 1,055.00
	Y	.00024		\$ 774.00	\$ 1,004.00
	Z	.00032		\$ 774.00	\$ 1,004.00
8.5101 to 9.260 216.151mm to 235.20mm	XX	See chart	#17 13 1/4 1 1/2	\$ 1,005.00	\$ 1,308.00
	X			\$ 911.00	\$ 1,186.00
	Y			\$ 867.00	\$ 1,127.00
	Z			\$ 867.00	\$ 1,127.00

**PLEASE CONTACT FACTORY FOR SIZES
OVER 9.260" (235.20mm)**

SIZES TO 30" (INCH) AVAILABLE, CONTACT
FACTORY.

RINGS ABOVE 5.510 WILL NOT BE SUPPLIED
WITH TAPPED HOLES FOR BALL HANDLES
UNLESS REQUESTED.

#7 BALL HANDLES AVAILABLE AT \$45.00 EACH.

**QUANTITY DISCOUNT 5 OR MORE OF
IDENTICAL SIZE LESS 10%**

CYLINDRICAL TOLERANCE CHARTS

SIZE RANGE		TOLERANCE IN INCHES					
Above	To	XXX	XX	X	Y	Z	ZZ
0.02	0.825	0.00001	0.00002	0.00004	0.00007	0.0001	0.0002
0.825	1.51	0.000015	0.00003	0.00006	0.00009	0.00012	0.00024
1.51	2.51	0.00002	0.00004	0.00008	0.00012	0.00016	0.00032
2.51	4.51	0.000025	0.00005	0.0001	0.00015	0.0002	0.0004
4.51	6.51	0.000032	0.000065	0.00013	0.00019	0.00025	0.0005
6.51	9.51	0.00004	0.00008	0.00016	0.00024	0.00032	0.00064
9.51	12.01	0.00005	0.0001	0.0002	0.0003	0.0004	0.0008

**MASTER SETTING DISCS
STEEL & CHROME**

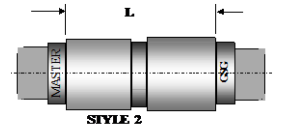
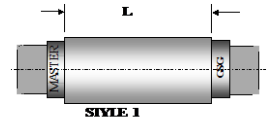
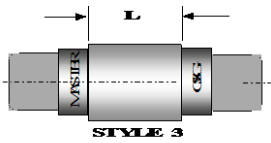

All Cylindrical Master Discs are manufactured to ASME/ANSI B47.1 AGD standard and ASME/ANSI B89.1.5. Master Discs above 2.510in / 63.75mm are black oxidized on all non-gaging surfaces. Black anodized aluminum holders available upon request.

CLASS XXX PLEASE CONTACT FACTORY
QUANTITY DISCOUNT 5 OR MORE OF IDENTICAL SIZE LESS 10%
CLASS Z PRICED SAME AS Y CLASS

Size	Class	Tolerance	Length	Bilateral Tolerance		Go Minus / NoGo Plus		Bilateral Tolerance	
				STYLE 3		STYLE 2		STYLE 1	
				QUANTITY 1		QUANTITY 1		QUANTITY 1	
				STEEL	CHROME	STEEL	CHROME	STEEL	CHROME
.105 to .150 2.671mm to 3.81mm	XX	.000020	#3 3/8	\$ 95.00	\$ 123.00	\$ 183.00	\$ 238.00	\$ 109.00	\$ 142.00
	X	.000040	#2 3/4	\$ 87.00	\$ 113.00	\$ 166.00	\$ 215.00	\$ 100.00	\$ 130.00
	Y	.000070	#1 3/4	\$ 83.00	\$ 109.00	\$ 158.00	\$ 205.00	\$ 93.00	\$ 121.00
.1501 to .230 3.811mm to 5.84mm	XX	.000020	#3 7/16	\$ 95.00	\$ 123.00	\$ 183.00	\$ 238.00	\$ 109.00	\$ 142.00
	X	.000040	#2 7/8	\$ 87.00	\$ 113.00	\$ 166.00	\$ 215.00	\$ 100.00	\$ 130.00
	Y	.000070	#1 7/8	\$ 83.00	\$ 109.00	\$ 158.00	\$ 205.00	\$ 93.00	\$ 121.00
.2301 to .365 5.841mm to 9.27mm	XX	.000020	#3 1/2	\$ 97.00	\$ 127.00	\$ 184.00	\$ 239.00	\$ 110.00	\$ 143.00
	X	.000040	#2 1	\$ 88.00	\$ 114.00	\$ 167.00	\$ 216.00	\$ 101.00	\$ 132.00
	Y	.000070	#1 1	\$ 84.00	\$ 109.00	\$ 159.00	\$ 208.00	\$ 95.00	\$ 122.00
.3651 to .510 9.271mm to 12.95mm	XX	.000020	#3 9/16	\$ 100.00	\$ 129.00	\$ 186.00	\$ 242.00	\$ 111.00	\$ 145.00
	X	.000040	#2 1 1/8	\$ 88.00	\$ 115.00	\$ 170.00	\$ 220.00	\$ 102.00	\$ 132.00
	Y	.000070	#1 1 1/8	\$ 84.00	\$ 110.00	\$ 160.00	\$ 210.00	\$ 95.00	\$ 123.00
.5101 to .825 12.951mm to 20.96mm	XX	.000020	#3 5/8	\$ 101.00	\$ 132.00	\$ 188.00	\$ 243.00	\$ 113.00	\$ 146.00
	X	.000040	#2 1 1/4	\$ 89.00	\$ 115.00	\$ 171.00	\$ 222.00	\$ 102.00	\$ 134.00
	Y	.000070	#1 1 1/4	\$ 85.00	\$ 111.00	\$ 161.00	\$ 211.00	\$ 97.00	\$ 127.00
.8251 to 1.135 20.961mm to 28.83mm	XX	.000030	#3 11/16	\$ 108.00	\$ 140.00	\$ 200.00	\$ 259.00	\$ 115.00	\$ 150.00
	X	.000060	#2 1 3/8	\$ 91.00	\$ 117.00	\$ 174.00	\$ 224.00	\$ 105.00	\$ 136.00
	Y	.000090	#1 1 3/8	\$ 87.00	\$ 113.00	\$ 166.00	\$ 214.00	\$ 101.00	\$ 132.00
1.1351 to 1.510 28.831mm to 38.35mm	XX	.000030	#3 13/16	\$ 116.00	\$ 151.00	\$ 222.00	\$ 288.00	\$ 129.00	\$ 167.00
	X	.000060	#2 1 5/8	\$ 92.00	\$ 121.00	\$ 176.00	\$ 229.00	\$ 109.00	\$ 140.00
	Y	.000090	#1 1 5/8	\$ 88.00	\$ 115.00	\$ 168.00	\$ 220.00	\$ 104.00	\$ 135.00
1.5101 to 2.010 38.351mm to 51.05mm	XX	.000040	#3 7/8	\$ 135.00	\$ 175.00	\$ 253.00	\$ 328.00	\$ 157.00	\$ 202.00
	X	.000080	#2 2	\$ 118.00	\$ 157.00	\$ 227.00	\$ 299.00	\$ 127.00	\$ 164.00
	Y	.00012	#1 1 7/8	\$ 114.00	\$ 148.00	\$ 220.00	\$ 283.00	\$ 118.00	\$ 157.00
2.0101 to 2.510 51.051mm to 63.75mm	XX	.000040	#3 7/8	\$ 157.00	\$ 203.00	\$ 295.00	\$ 384.00	\$ 168.00	\$ 220.00
	X	.000080	#2 2	\$ 122.00	\$ 159.00	\$ 233.00	\$ 303.00	\$ 142.00	\$ 184.00
	Y	.00012	#1 2	\$ 116.00	\$ 151.00	\$ 223.00	\$ 289.00	\$ 135.00	\$ 175.00
2.5101 to 3.010 63.751mm to 76.45mm	XX	.000050	#3 1	\$ 177.00	\$ 230.00	\$ 340.00	\$ 440.00	\$ 193.00	\$ 253.00
	X	.0001	#2 2 1/4	\$ 147.00	\$ 192.00	\$ 282.00	\$ 366.00	\$ 154.00	\$ 198.00
	Y	.00015	#1 2	\$ 140.00	\$ 184.00	\$ 267.00	\$ 349.00	\$ 146.00	\$ 189.00
3.0101 to 3.510 76.451mm to 89.15mm	XX	.000050	#3 1	\$ 249.00	\$ 323.00	\$ 473.00	\$ 613.00	\$ 299.00	\$ 388.00
	X	.0001	#2 2 1/4	\$ 225.00	\$ 292.00	\$ 428.00	\$ 555.00	\$ 270.00	\$ 352.00
	Y	.00015	#1 2	\$ 214.00	\$ 279.00	\$ 409.00	\$ 529.00	\$ 257.00	\$ 334.00
3.5101 to 4.010 89.151mm to 101.85mm	XX	.000050	#3 1	\$ 253.00	\$ 328.00	\$ 479.00	\$ 623.00	\$ 321.00	\$ 414.00
	X	.0001	#2 2 1/4	\$ 227.00	\$ 299.00	\$ 436.00	\$ 566.00	\$ 289.00	\$ 375.00
	Y	.00015	#1 2 1/8	\$ 220.00	\$ 283.00	\$ 413.00	\$ 539.00	\$ 277.00	\$ 360.00
4.0101 to 4.510 101.851mm to 114.55mm	XX	.000050	#3 1	\$ 257.00	\$ 334.00	\$ 490.00	\$ 636.00	\$ 328.00	\$ 427.00
	X	.0001	#2 2 1/4	\$ 233.00	\$ 303.00	\$ 441.00	\$ 577.00	\$ 299.00	\$ 388.00
	Y	.00015	#1 2 1/8	\$ 223.00	\$ 289.00	\$ 422.00	\$ 548.00	\$ 283.00	\$ 368.00
4.5101 to 5.010 114.551mm to 127.25mm	XX	.000065	#3 1	\$ 268.00	\$ 351.00	\$ 510.00	\$ 664.00	\$ 410.00	\$ 532.00
	X	.00013	#2 2 1/4	\$ 246.00	\$ 317.00	\$ 464.00	\$ 604.00	\$ 371.00	\$ 482.00
	Y	.00019	#1 2 1/8	\$ 233.00	\$ 302.00	\$ 440.00	\$ 574.00	\$ 355.00	\$ 461.00
5.0101 to 5.510 127.251mm to 139.95mm	XX	.000065	#3 1	\$ 278.00	\$ 362.00	\$ 539.00	\$ 700.00	\$ 420.00	\$ 546.00
	X	.00013	#2 2 1/4	\$ 249.00	\$ 325.00	\$ 474.00	\$ 616.00	\$ 383.00	\$ 496.00
	Y	.00019	#1 2 1/8	\$ 238.00	\$ 308.00	\$ 451.00	\$ 586.00	\$ 363.00	\$ 473.00
5.5101 to 6.010 139.951mm to 152.65mm	XX	.000065	#3 1	\$ 295.00	\$ 384.00	\$ 577.00	\$ 751.00	\$ 435.00	\$ 564.00
	X	.00013	#2 2 1/4	\$ 253.00	\$ 329.00	\$ 480.00	\$ 626.00	\$ 393.00	\$ 510.00
	Y	.00019	#1 2 1/8	\$ 242.00	\$ 314.00	\$ 460.00	\$ 595.00	\$ 373.00	\$ 485.00

CLASS Z PRICED SAME AS Y CLASS
Quantity (5) or more of same size less 10%

MASTER SETTING DISCS
STEEL & CHROME

Discs above 8.010 will be trilock design, not annular

Contact Factory for pricing on sizes 8.010 to 36.00" Style #3

Size	Class	Tolerance	Length	Bilateral Tolerance		Go Minus / NoGo Plus		Bilateral Tolerance	
				STYLE 3		STYLE 2		STYLE 1	
				QUANTITY 1		QUANTITY 1		QUANTITY 1	
				STEEL	CHROME	STEEL	CHROME	STEEL	CHROME
6.010 to 6.510 152.651mm to 165.35mm	XX	.000065	#3 1	\$ 345.00	\$ 448.00	\$ 665.00	\$ 863.00	\$ 476.00	\$ 620.00
	X	.00013	#2 2 1/4	\$ 275.00	\$ 359.00	\$ 593.00	\$ 770.00	\$ 433.00	\$ 562.00
	Y	.00019	#1 2 1/8	\$ 263.00	\$ 343.00	\$ 563.00	\$ 732.00	\$ 413.00	\$ 535.00
6.5101 to 7.010 165.351mm to 178.05mm	XX	.000080	#3 1	\$ 434.00	\$ 563.00	\$ 825.00	\$ 987.00	\$ 739.00	\$ 961.00
	X	.00016	#2 2 1/4	\$ 392.00	\$ 511.00	\$ 750.00	\$ 970.00	\$ 672.00	\$ 871.00
	Y	.00024	#1 2 1/8	\$ 376.00	\$ 488.00	\$ 711.00	\$ 925.00	\$ 639.00	\$ 828.00
7.0101 to 7.510 178.051mm to 190.75mm	XX	.000080	#3 1	\$ 443.00	\$ 576.00	\$ 841.00	\$ 1,093.00	\$ 758.00	\$ 985.00
	X	.00016	#2 2 1/4	\$ 403.00	\$ 523.00	\$ 763.00	\$ 991.00	\$ 685.00	\$ 891.00
	Y	.00024	#1 2 1/8	\$ 382.00	\$ 498.00	\$ 727.00	\$ 945.00	\$ 653.00	\$ 850.00
7.5101 to 8.010 190.751mm to 203.45mm	XX	.000080	#3 1	\$ 452.00	\$ 586.00	\$ 857.00	\$ 1,115.00	\$ 792.00	\$ 1,030.00
	X	.00016	#2 2 1/4	\$ 410.00	\$ 533.00	\$ 779.00	\$ 1,010.00	\$ 717.00	\$ 934.00
	Y	.00024	#1 2 1/8	\$ 389.00	\$ 507.00	\$ 740.00	\$ 964.00	\$ 684.00	\$ 889.00

Quantity (5) or more of same size less 10%

CARBIDE

Size	Class	Tolerance	STYLE 3		STYLE 2		STYLE 1	
			Length	Qty 1	Length	Qty 1	Length	Qty 1
.150 to .185 3.810mm to 4.70mm	XX	.000020		\$ 132.00		\$ 213.00		\$ 134.00
	X	.000040	7/16	\$ 120.00	7/8	\$ 195.00	7/8	\$ 121.00
	Y	.00007		\$ 115.00		\$ 191.00		\$ 119.00
	Z	.0001		\$ 107.00		\$ 185.00		\$ 114.00
.1851 to .230 4.701mm to 5.84mm	XX	.00002		\$ 145.00		\$ 240.00		\$ 148.00
	X	.000040	7/16	\$ 131.00	7/8	\$ 220.00	7/8	\$ 133.00
	Y	.000070		\$ 121.00		\$ 213.00		\$ 129.00
	Z	.0001		\$ 115.00		\$ 208.00		\$ 121.00
.2301 to .281 5.841mm to 7.14mm	XX	.000020		\$ 153.00		\$ 254.00		\$ 158.00
	X	.000040	1/2	\$ 134.00	1	\$ 233.00	1	\$ 140.00
	Y	.000070		\$ 131.00		\$ 231.00		\$ 132.00
	Z	.0001		\$ 122.00		\$ 224.00		\$ 126.00
.2811 to .365 7.141mm to 9.27mm	XX	.000020		\$ 158.00		\$ 272.00		\$ 165.00
	X	.000040	1/2	\$ 142.00	1	\$ 245.00	1	\$ 145.00
	Y	.000070		\$ 134.00		\$ 238.00		\$ 140.00
	Z	.0001		\$ 128.00		\$ 233.00		\$ 131.00
.3651 to .469 9.271mm to 11.91mm	XX	.000020		\$ 167.00		\$ 292.00		\$ 175.00
	X	.000040	9/16	\$ 152.00	1 1/8	\$ 278.00	1 1/8	\$ 158.00
	Y	.000070		\$ 146.00		\$ 272.00		\$ 148.00
	Z	.000070		\$ 140.00		\$ 266.00		\$ 141.00
.4691 to .510 11.911mm to 12.95mm	XX	.000020		\$ 185.00		\$ 327.00		\$ 180.00
	X	.000040	9/16	\$ 168.00	1 1/8	\$ 304.00	1 1/8	\$ 165.00
	Y	.000070		\$ 165.00		\$ 302.00		\$ 161.00
	Z	.0001		\$ 156.00		\$ 296.00		\$ 153.00
.5101 to .563 12.951mm to 14.30mm	XX	.000020		\$ 195.00		\$ 348.00		\$ 201.00
	X	.000040	5/8	\$ 178.00	1 1/4	\$ 322.00	1 1/4	\$ 181.00
	Y	.000070		\$ 173.00		\$ 319.00		\$ 178.00
	Z	.000070		\$ 166.00		\$ 314.00		\$ 169.00
.5631 to .625 14.301mm to 15.87mm	XX	.000020		\$ 205.00		\$ 362.00		\$ 211.00
	X	.000040	5/8	\$ 187.00	1 1/4	\$ 334.00	1 1/4	\$ 192.00
	Y	.000070		\$ 179.00		\$ 331.00		\$ 187.00
	Z	.0001		\$ 172.00		\$ 326.00		\$ 179.00
.6251 to .656 15.871mm to 16.66mm	XX	.000020		\$ 213.00		\$ 372.00		\$ 221.00
	X	.000040	5/8	\$ 195.00	1 1/4	\$ 345.00	1 1/4	\$ 201.00
	Y	.000070		\$ 191.00		\$ 340.00		\$ 195.00
	Z	.000070		\$ 184.00		\$ 334.00		\$ 187.00
0.6561 to .7180 16.661mm to 18.23mm	XX	.000020		\$ 224.00		\$ 402.00		\$ 231.00
	X	.000040	5/8	\$ 204.00	1 1/4	\$ 374.00	1 1/4	\$ 209.00
	Y	.000070		\$ 198.00		\$ 368.00		\$ 205.00
	Z	.0001		\$ 188.00		\$ 364.00		\$ 198.00
.7181 to .750 18.231mm to 19.05mm	XX	.000020		\$ 231.00		\$ 433.00		\$ 238.00
	X	.000040	5/8	\$ 212.00	1 1/4	\$ 401.00	1 1/4	\$ 221.00
	Y	.000070		\$ 208.00		\$ 398.00		\$ 213.00
	Z	.000070		\$ 200.00		\$ 392.00		\$ 207.00
.7501 to .781 19.051mm to 19.83mm	XX	.000020		\$ 266.00		\$ 444.00		\$ 272.00
	X	.000040	5/8	\$ 245.00	1 1/4	\$ 413.00	1 1/4	\$ 252.00
	Y	.000070		\$ 240.00		\$ 411.00		\$ 248.00
	Z	.0001		\$ 233.00		\$ 405.00		\$ 240.00
.7811 to .825 19.831mm to 20.96mm	XX	.000020		\$ 275.00		\$ 445.00		\$ 282.00
	X	.000040	5/8	\$ 254.00	1 1/4	\$ 415.00	1 1/4	\$ 260.00
	Y	.000070		\$ 249.00		\$ 413.00		\$ 258.00
	Z	.000070		\$ 247.00		\$ 407.00		\$ 249.00
.8251 to .875 20.961mm to 22.22mm	XX	.000030		\$ 321.00		\$ 468.00		\$ 313.00
	X	.000060	11/16	\$ 299.00	1 3/8	\$ 440.00	1 3/8	\$ 291.00
	Y	.000090		\$ 296.00		\$ 432.00		\$ 287.00
	Z	.000012		\$ 289.00		\$ 431.00		\$ 280.00

XXX Available in Carbide Only
See page 25

REVERSIBLE
CYLINDRICAL PLUG GAGES
STEEL & CHROME

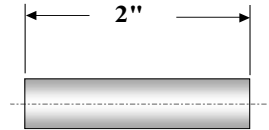

QUANTITY DISCOUNT 5 OR MORE OF IDENTICAL SIZE LESS 10%

Size	Class	Tol	QUANTITY 1		Handle EDP #	Handle #	Handle Price
			STEEL	CHROME			
.010 to .030 0.251mm to 0.762mm	XX	.000020	\$ 58.00		HDL000005	1 WDE	\$ 12.00
	X	.000040	\$ 48.00		HDL000005	1 WDE	\$ 12.00
	Y	.000070	\$ 44.00		HDL000005	1 WDE	\$ 12.00
	Z	.0001	\$ 38.00		HDL000005	1 WDE	\$ 12.00
.0301 to .075 0.763mm to 1.91mm	XX	.000020	\$ 31.00	\$ 40.00	HDL000005	1 WDE	\$ 12.00
	X	.000040	\$ 24.00	\$ 31.00	HDL000005	1 WDE	\$ 12.00
	Y	.000070	\$ 22.00	\$ 27.00	HDL000005	1 WDE	\$ 12.00
	Z	.0001	\$ 19.00	\$ 24.00	HDL000005	1 WDE	\$ 12.00
.0751 to .180 1.911mm to 4.57mm	XX	.000020	\$ 33.00	\$ 46.00	HDL000010	2 WDE	\$ 12.00
	X	.000040	\$ 29.00	\$ 36.00	HDL000010	2 WDE	\$ 12.00
	Y	.000070	\$ 27.00	\$ 33.00	HDL000010	2 WDE	\$ 12.00
	Z	.0001	\$ 22.00	\$ 27.00	HDL000010	2 WDE	\$ 12.00
.1801 to .281 4.571mm to 7.14mm	XX	.000020	\$ 34.00	\$ 47.00	HDL000015	3 WDE	\$ 13.00
	X	.000040	\$ 29.00	\$ 36.00	HDL000015	3 WDE	\$ 13.00
	Y	.000070	\$ 27.00	\$ 33.00	HDL000015	3 WDE	\$ 13.00
	Z	.0001	\$ 23.00	\$ 30.00	HDL000015	3 WDE	\$ 13.00
.2811 to .406 7.141mm to 10.31mm	XX	.000020	\$ 38.00	\$ 51.00	HDL000020	4 WDE	\$ 14.00
	X	.000040	\$ 32.00	\$ 44.00	HDL000020	4 WDE	\$ 14.00
	Y	.000070	\$ 30.00	\$ 38.00	HDL000020	4 WDE	\$ 14.00
	Z	.0001	\$ 23.00	\$ 30.00	HDL000020	4 WDE	\$ 14.00
.4061 to .510 10.311mm to 12.95mm	XX	.000020	\$ 40.00	\$ 52.00	HDL000025	5 WDE	\$ 14.00
	X	.000040	\$ 33.00	\$ 46.00	HDL000025	5 WDE	\$ 14.00
	Y	.000070	\$ 31.00	\$ 42.00	HDL000025	5 WDE	\$ 14.00
	Z	.0001	\$ 26.00	\$ 32.00	HDL000025	5 WDE	\$ 14.00
.5101 to .635 12.951mm to 16.13mm	XX	.000020	\$ 44.00	\$ 57.00	HDL000029	6 WDE	\$ 15.00
	X	.000040	\$ 34.00	\$ 47.00	HDL000029	6 WDE	\$ 15.00
	Y	.000070	\$ 33.00	\$ 46.00	HDL000029	6 WDE	\$ 15.00
	Z	.0001	\$ 27.00	\$ 33.00	HDL000029	6 WDE	\$ 15.00
.6351 to .760 16.131mm to 19.30mm	XX	.000020	\$ 46.00	\$ 58.00	HDL000033	7 WDE	\$ 15.00
	X	.000040	\$ 38.00	\$ 51.00	HDL000033	7 WDE	\$ 15.00
	Y	.000070	\$ 34.00	\$ 47.00	HDL000033	7 WDE	\$ 15.00
	Z	.0001	\$ 29.00	\$ 36.00	HDL000033	7 WDE	\$ 15.00
.7601 to 1.010 19.301mm to 25.65mm	XX		\$ 73.00	\$ 92.00	HDL000035	8 WDE	\$ 23.00
	X	See	\$ 60.00	\$ 79.00	HDL000035	8 WDE	\$ 23.00
	Y	Chart	\$ 54.00	\$ 73.00	HDL000035	8 WDE	\$ 23.00
	Z		\$ 49.00	\$ 64.00	HDL000035	8 WDE	\$ 23.00

**DEPTH STEPS FOR STEEL & CHROME REVERSIBLES,
TAPERLOCKS & TRILOCKS**

Depth steps above .125 inch / 3.175 mm diameter only.

Extra length members 2 to 4 inches add 50%, 4 to 6 inches add 100%

1 Member		
1 Step	2 Steps	4 Steps
\$ 35.00	\$ 70.00	\$ 120.00

**AIR GROOVES FOR STEEL & CHROME REVERSIBLES,
TAPERLOCKS & TRILOCKS**

Add \$ 30.00 for the first member and \$ 20.00 for additional members on same order. Extra length members 2 to 4 inches add 50%, 4 to 6 inches add 100%.

EXTRA LENGTH MEMBER PRICING STEEL & CHROME

Extra length members up to max 6" length above .075" price x length in even increments of one inch.

Extra length members below .075" see page 26.

EXTRA LENGTH MEMBERS ON PAGE 26

**REVERSIBLE
CYLINDRICAL PLUG GAGES
CARBIDE**

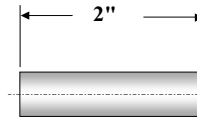

STANDARD PRICING

QUANTITY DISCOUNT 5 OR MORE OF IDENTICAL SIZE LESS 10%
FOR CLASS XXX IN SIZES .760" - 1.00" CONTACT FACTORY

Size	Class	Tol	Member Length	QUANTITY 1	Handle EDP #	Handle #	Handle Price
.040 to .075 1.021mm to 1.91mm	XX	.000020		\$ 93.00	HDL000005	1 WDE	\$ 12.00
	X	.000040	2 inch	\$ 86.00	HDL000005	1 WDE	\$ 12.00
	Y	.000070	50.8 mm	\$ 80.00	HDL000005	1 WDE	\$ 12.00
	Z	.0001		\$ 75.00	HDL000005	1 WDE	\$ 12.00
.0751 to .115 1.911mm to 2.92mm	XX	.000020		\$ 67.00	HDL000010	2 WDE	\$ 12.00
	X	.000040	2 inch	\$ 58.00	HDL000010	2 WDE	\$ 12.00
	Y	.000070	50.8 mm	\$ 54.00	HDL000010	2 WDE	\$ 12.00
	Z	.0001		\$ 51.00	HDL000010	2 WDE	\$ 12.00
.1151 to .130 2.921mm to 3.30mm	XX	.000020		\$ 69.00	HDL000010	2 WDE	\$ 12.00
	X	.000040	2 inch	\$ 62.00	HDL000010	2 WDE	\$ 12.00
	Y	.000070	50.8 mm	\$ 60.00	HDL000010	2 WDE	\$ 12.00
	Z	.0001		\$ 55.00	HDL000010	2 WDE	\$ 12.00
.1301 to .180 3.301mm to 4.57mm	XX	.000020		\$ 71.00	HDL000010	2 WDE	\$ 12.00
	X	.000040	2 inch	\$ 64.00	HDL000010	2 WDE	\$ 12.00
	Y	.000070	50.8 mm	\$ 60.00	HDL000010	2 WDE	\$ 12.00
	Z	.0001		\$ 56.00	HDL000010	2 WDE	\$ 12.00
.1801 to .230 4.571mm to 5.84mm	XX	.000020		\$ 75.00	HDL000015	3 WDE	\$ 13.00
	X	.000040	2 inch	\$ 67.00	HDL000015	3 WDE	\$ 13.00
	Y	.000070	50.8 mm	\$ 64.00	HDL000015	3 WDE	\$ 13.00
	Z	.0001		\$ 60.00	HDL000015	3 WDE	\$ 13.00
.2301 to .281 5.841mm to 7.14mm	XX	.000020		\$ 81.00	HDL000015	3 WDE	\$ 13.00
	X	.000040	2 inch	\$ 75.00	HDL000015	3 WDE	\$ 13.00
	Y	.000070	50.8 mm	\$ 73.00	HDL000015	3 WDE	\$ 13.00
	Z	.0001		\$ 68.00	HDL000015	3 WDE	\$ 13.00
.2811 to .344 7.141mm to 8.74mm	XX	.000020		\$ 86.00	HDL000020	4 WDE	\$ 14.00
	X	.000040	2 inch	\$ 80.00	HDL000020	4 WDE	\$ 14.00
	Y	.000070	50.8 mm	\$ 78.00	HDL000020	4 WDE	\$ 14.00
	Z	.0001		\$ 73.00	HDL000020	4 WDE	\$ 14.00
.3441 to .406 8.741mm to 10.31mm	XX	.000020		\$ 92.00	HDL000020	4 WDE	\$ 14.00
	X	.000040	2 inch	\$ 87.00	HDL000020	4 WDE	\$ 14.00
	Y	.000070	50.8 mm	\$ 84.00	HDL000020	4 WDE	\$ 14.00
	Z	.0001		\$ 80.00	HDL000020	4 WDE	\$ 14.00
.4061 to .460 10.311mm to 11.68mm	XX	.000020		\$ 102.00	HDL000025	5 WDE	\$ 14.00
	X	.000040	2 inch	\$ 95.00	HDL000025	5 WDE	\$ 14.00
	Y	.000070	50.8 mm	\$ 93.00	HDL000025	5 WDE	\$ 14.00
	Z	.0001		\$ 91.00	HDL000025	5 WDE	\$ 14.00
.4601 to .510 11.681mm to 12.95mm	XX	.000020		\$ 109.00	HDL000025	5 WDE	\$ 14.00
	X	.000040	2 inch	\$ 105.00	HDL000025	5 WDE	\$ 14.00
	Y	.000070	50.8 mm	\$ 101.00	HDL000025	5 WDE	\$ 14.00
	Z	.0001		\$ 98.00	HDL000025	5 WDE	\$ 14.00
.5101 to .560 12.951mm to 14.22mm	XX	.000020		\$ 142.00	HDL000029	6 WDE	\$ 15.00
	X	.000040	2 inch	\$ 132.00	HDL000029	6 WDE	\$ 15.00
	Y	.000070	50.8 mm	\$ 128.00	HDL000029	6 WDE	\$ 15.00
	Z	.0001		\$ 126.00	HDL000029	6 WDE	\$ 15.00
.5601 to .635 14.221mm to 16.13mm	XX	.000020		\$ 156.00	HDL000029	6 WDE	\$ 15.00
	X	.000040	2 inch	\$ 148.00	HDL000029	6 WDE	\$ 15.00
	Y	.000070	50.8 mm	\$ 145.00	HDL000029	6 WDE	\$ 15.00
	Z	.0001		\$ 140.00	HDL000029	6 WDE	\$ 15.00
.6351 to .700 16.131mm to 17.78mm	XX	.000020		\$ 180.00	HDL000033	7 WDE	\$ 15.00
	X	.000040	2 inch	\$ 175.00	HDL000033	7 WDE	\$ 15.00
	Y	.000070	50.8 mm	\$ 169.00	HDL000033	7 WDE	\$ 15.00
	Z	.0001		\$ 162.00	HDL000033	7 WDE	\$ 15.00
.7001 to .760 17.781mm to 19.30mm	XX	.000020		\$ 216.00	HDL000033	7 WDE	\$ 15.00
	X	.000040	2 inch	\$ 205.00	HDL000033	7 WDE	\$ 15.00
	Y	.000070	50.8 mm	\$ 201.00	HDL000033	7 WDE	\$ 15.00
	Z	.0001		\$ 195.00	HDL000033	7 WDE	\$ 15.00

DEPTH STEPS FOR CARBIDE REVERSIBLES, TAPERLOCKS & TRILOCKS

Extra length members 2-4" add 50%, 4-6" add 100%

1 Member		
1 Step	2 Steps	4 Steps
\$ 55.00	\$ 95.00	\$ 175.00

AIR GROOVES FOR CARBIDE REVERSIBLES, TAPERLOCKS & TRILOCKS

Add \$ 40.00 for the first member and \$ 30.00 for additional members on same order.

Extra length members see page 26.

**REVERSIBLE
CYLINDRICAL PLUG GAGES
EXTRA LENGTH**

For extra length members: Roundness not to exceed 50% of gage makers size tolerance. Taper not to exceed the total gage makers tolerance. Straightness to be calculated as tolerance multiplied by length in inches (not to exceed .0002").

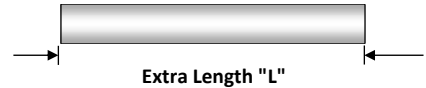

**FOR XXX PRICING CALL FACTORY - XXX NOT AVAILABLE WITH STEEL OR CHROME
QUANTITY DISCOUNT 5 OR MORE OF IDENTICAL SIZE LESS 10%**

STEEL									
Size	Class	Tol	Length "L"				Handle EDP #	Handle #	Handle Price
			3"	4"	5"	6"			
.010 to .030 .254mm to .762mm	XX	.000020	\$ 348.00	\$ 490.00	\$ 775.00	\$ 1,084.00	HDL000005	1 WDE	\$ 12.00
	X	.000040	\$ 291.00	\$ 400.00	\$ 727.00	\$ 941.00	HDL000005	1 WDE	\$ 12.00
	Y	.000070	\$ 271.00	\$ 377.00	\$ 720.00	\$ 924.00	HDL000005	1 WDE	\$ 12.00
	Z	.0001	\$ 243.00	\$ 339.00	\$ 648.00	\$ 833.00	HDL000005	1 WDE	\$ 12.00
.0301 to .060 .763mm to 1.52mm	XX	.000020	\$ 130.00	\$ 185.00	\$ 290.00	\$ 422.00	HDL000005	1 WDE	\$ 12.00
	X	.000040	\$ 110.00	\$ 150.00	\$ 282.00	\$ 366.00	HDL000005	1 WDE	\$ 12.00
	Y	.000070	\$ 102.00	\$ 141.00	\$ 272.00	\$ 361.00	HDL000005	1 WDE	\$ 12.00
	Z	.0001	\$ 99.00	\$ 138.00	\$ 251.00	\$ 337.00	HDL000005	1 WDE	\$ 12.00
.0601 to .075 1.521mm to 1.90mm	XX	.000020	\$ 95.00	\$ 130.00	\$ 152.00	\$ 195.00	HDL000005	1 WDE	\$ 12.00
	X	.000040	\$ 75.00	\$ 102.00	\$ 135.00	\$ 162.00	HDL000005	1 WDE	\$ 12.00
	Y	.000070	\$ 67.00	\$ 97.00	\$ 134.00	\$ 159.00	HDL000005	1 WDE	\$ 12.00
	Z	.0001	\$ 59.00	\$ 87.00	\$ 121.00	\$ 140.00	HDL000005	1 WDE	\$ 12.00
.0751 to 1.010 1.901mm to 25.65mm	Price times length in even increments of one inch. See page 23.								

**FOR XXX PRICING CALL FACTORY - XXX NOT AVAILABLE WITH STEEL OR CHROME
SIZES .760" - 1.00" CONTACT FACTORY**

QUANTITY DISCOUNT 5 OR MORE OF IDENTICAL SIZE LESS 10%

CARBIDE									
Size	Class	Tol	Length "L"				Handle EDP #	Handle #	Handle Price
			3"	4"	5"	6"			
.115 to .180 2.921mm to 4.57mm	XX	.000020	\$ 174.00	\$ 244.00			HDL000010	2 WDE	\$ 12.00
	X	.000040	\$ 161.00	\$ 234.00			HDL000010	2 WDE	\$ 12.00
	Y	.000070	\$ 154.00	\$ 225.00			HDL000010	2 WDE	\$ 12.00
	Z	.0001	\$ 146.00	\$ 216.00			HDL000010	2 WDE	\$ 12.00
.1801 to .230 4.571mm to 5.84mm	XX	.000020	\$ 129.00	\$ 191.00	\$ 235.00	\$ 296.00	HDL000015	3 WDE	\$ 13.00
	X	.000040	\$ 122.00	\$ 181.00	\$ 226.00	\$ 286.00	HDL000015	3 WDE	\$ 13.00
	Y	.000070	\$ 118.00	\$ 174.00	\$ 221.00	\$ 274.00	HDL000015	3 WDE	\$ 13.00
	Z	.0001	\$ 109.00	\$ 165.00	\$ 211.00	\$ 266.00	HDL000015	3 WDE	\$ 13.00
.2301 to .281 5.841mm to 7.14mm	XX	.000020	\$ 142.00	\$ 209.00	\$ 321.00	\$ 402.00	HDL000015	3 WDE	\$ 13.00
	X	.000040	\$ 136.00	\$ 198.00	\$ 313.00	\$ 393.00	HDL000015	3 WDE	\$ 13.00
	Y	.000070	\$ 128.00	\$ 192.00	\$ 304.00	\$ 384.00	HDL000015	3 WDE	\$ 13.00
	Z	.0001	\$ 122.00	\$ 181.00	\$ 293.00	\$ 349.00	HDL000015	3 WDE	\$ 13.00
.2811 to .344 7.141mm to 8.74mm	XX	.000020	\$ 175.00	\$ 252.00	\$ 340.00	\$ 420.00	HDL000020	4 WDE	\$ 14.00
	X	.000040	\$ 169.00	\$ 244.00	\$ 329.00	\$ 411.00	HDL000020	4 WDE	\$ 14.00
	Y	.000070	\$ 161.00	\$ 234.00	\$ 321.00	\$ 402.00	HDL000020	4 WDE	\$ 14.00
	Z	.0001	\$ 154.00	\$ 226.00	\$ 314.00	\$ 366.00	HDL000020	4 WDE	\$ 14.00
.3441 to .406 8.741mm to 10.31mm	XX	.000020	\$ 192.00	\$ 286.00	\$ 355.00	\$ 444.00	HDL000020	4 WDE	\$ 14.00
	X	.000040	\$ 181.00	\$ 278.00	\$ 349.00	\$ 433.00	HDL000020	4 WDE	\$ 14.00
	Y	.000070	\$ 174.00	\$ 269.00	\$ 339.00	\$ 426.00	HDL000020	4 WDE	\$ 14.00
	Z	.0001	\$ 165.00	\$ 260.00	\$ 329.00	\$ 416.00	HDL000020	4 WDE	\$ 14.00
.4061 to .460 10.311mm to 11.68mm	XX	.000020	\$ 195.00	\$ 293.00	\$ 372.00	\$ 460.00	HDL000025	5 WDE	\$ 14.00
	X	.000040	\$ 187.00	\$ 285.00	\$ 366.00	\$ 452.00	HDL000025	5 WDE	\$ 14.00
	Y	.000070	\$ 178.00	\$ 278.00	\$ 355.00	\$ 444.00	HDL000025	5 WDE	\$ 14.00
	Z	.0001	\$ 172.00	\$ 269.00	\$ 349.00	\$ 446.00	HDL000025	5 WDE	\$ 14.00
.4601 to .510 11.681mm to 12.95mm	XX	.000020	\$ 209.00	\$ 314.00	\$ 392.00	\$ 487.00	HDL000025	5 WDE	\$ 14.00
	X	.000040	\$ 198.00	\$ 302.00	\$ 381.00	\$ 475.00	HDL000025	5 WDE	\$ 14.00
	Y	.000070	\$ 191.00	\$ 293.00	\$ 372.00	\$ 468.00	HDL000025	5 WDE	\$ 14.00
	Z	.0001	\$ 181.00	\$ 285.00	\$ 365.00	\$ 459.00	HDL000025	5 WDE	\$ 14.00
.5101 to .560 12.951mm to 14.22mm	XX	.000020	\$ 244.00	\$ 366.00	\$ 468.00	\$ 574.00	HDL000029	6 WDE	\$ 15.00
	X	.000040	\$ 234.00	\$ 355.00	\$ 459.00	\$ 562.00	HDL000029	6 WDE	\$ 15.00
	Y	.000070	\$ 225.00	\$ 349.00	\$ 452.00	\$ 556.00	HDL000029	6 WDE	\$ 15.00
	Z	.0001	\$ 216.00	\$ 339.00	\$ 444.00	\$ 546.00	HDL000029	6 WDE	\$ 15.00
.5601 to .635 14.221mm to 16.13mm	XX	.000020	\$ 280.00	\$ 393.00	\$ 540.00	\$ 632.00	HDL000029	6 WDE	\$ 15.00
	X	.000040	\$ 260.00	\$ 369.00	\$ 531.00	\$ 622.00	HDL000029	6 WDE	\$ 15.00
	Y	.000070	\$ 252.00	\$ 364.00	\$ 521.00	\$ 612.00	HDL000029	6 WDE	\$ 15.00
	Z	.0001	\$ 244.00	\$ 353.00	\$ 511.00	\$ 602.00	HDL000029	6 WDE	\$ 15.00
.6351 to .700 16.131mm to 17.78mm	XX	.000020	\$ 364.00	\$ 494.00	\$ 659.00	\$ 833.00	HDL000033	7 WDE	\$ 15.00
	X	.000040	\$ 352.00	\$ 479.00	\$ 651.00	\$ 824.00	HDL000033	7 WDE	\$ 15.00
	Y	.000070	\$ 339.00	\$ 460.00	\$ 642.00	\$ 813.00	HDL000033	7 WDE	\$ 15.00
	Z	.0001	\$ 329.00	\$ 449.00	\$ 633.00	\$ 805.00	HDL000033	7 WDE	\$ 15.00
.7001 to .760 17.781mm to 19.30mm	XX	.000020	\$ 384.00	\$ 511.00	\$ 685.00	\$ 860.00	HDL000033	7 WDE	\$ 15.00
	X	.000040	\$ 369.00	\$ 496.00	\$ 678.00	\$ 849.00	HDL000033	7 WDE	\$ 15.00
	Y	.000070	\$ 362.00	\$ 484.00	\$ 668.00	\$ 840.00	HDL000033	7 WDE	\$ 15.00
	Z	.0001	\$ 349.00	\$ 468.00	\$ 656.00	\$ 832.00	HDL000033	7 WDE	\$ 15.00



GO

**TAPERLOCK
CYLINDRICAL PLUG GAGES
STEEL**

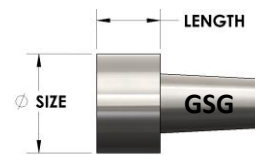

NO-GO

All Cylindrical Taperlock plug gages are manufactured to ASME/ANSI B47.1 AGD standard and ASME/ANSI B89.1.5 standard. Gaging surface is hardened to Rc 60-62.

QUANTITY DISCOUNT 5 OR MORE OF IDENTICAL SIZE LESS 10%

CHROME add 30%.

Size	Class	Tolerance	Length	QUANTITY 1		Handle EDP#	Handle #	Handle Price
				Go	Nogo			
.1051 to .150 2.671mm to 3.81mm	XX	.000020	Go 3/8	\$ 67.00	\$ 66.00	HDL000002	00	\$ 11.00
	X	.000040	NoGo 7/32	\$ 51.00	\$ 50.00	HDL000002	00	\$ 11.00
	Y	.000070		\$ 49.00	\$ 49.00	HDL000002	00	\$ 11.00
	Z	.0001		\$ 49.00	\$ 49.00	HDL000002	00	\$ 11.00
.1501 to .230 3.811mm to 5.84mm	XX	.000020	Go 13/32	\$ 67.00	\$ 66.00	HDL000003	0	\$ 11.00
	X	.000040	NoGo 9/32	\$ 51.00	\$ 50.00	HDL000003	0	\$ 11.00
	Y	.000070		\$ 50.00	\$ 49.00	HDL000003	0	\$ 11.00
	Z	.0001		\$ 50.00	\$ 49.00	HDL000003	0	\$ 11.00
.2301 to .365 5.841mm to 9.27mm	XX	.000020	Go 3/4	\$ 67.00	\$ 66.00	HDL000004	1	\$ 10.00
	X	.000040	NoGo 5/16	\$ 51.00	\$ 51.00	HDL000004	1	\$ 10.00
	Y	.000070		\$ 50.00	\$ 49.00	HDL000004	1	\$ 10.00
	Z	.0001		\$ 50.00	\$ 49.00	HDL000004	1	\$ 10.00
.3651 to .510 9.271mm to 12.95mm	XX	.000020	Go 1	\$ 70.00	\$ 67.00	HDL000009	2	\$ 10.00
	X	.000040	NoGo 3/8	\$ 52.00	\$ 52.00	HDL000009	2	\$ 10.00
	Y	.000070		\$ 50.00	\$ 50.00	HDL000009	2	\$ 10.00
	Z	.0001		\$ 50.00	\$ 50.00	HDL000009	2	\$ 10.00
.5101 to .825 12.951mm to 20.96mm	XX	.000020	Go 1 1/4	\$ 74.00	\$ 73.00	HDL000014	3	\$ 10.00
	X	.000040	NoGo 1/2	\$ 59.00	\$ 57.00	HDL000014	3	\$ 10.00
	Y	.000070		\$ 55.00	\$ 52.00	HDL000014	3	\$ 10.00
	Z	.0001		\$ 55.00	\$ 52.00	HDL000014	3	\$ 10.00
.8251 to 1.135 20.961mm to 28.83mm	XX	.000030	Go 1 1/2	\$ 77.00	\$ 75.00	HDL000019	4	\$ 11.00
	X	.000060	NoGo 5/8	\$ 61.00	\$ 59.00	HDL000019	4	\$ 11.00
	Y	.000090		\$ 57.00	\$ 55.00	HDL000019	4	\$ 11.00
	Z	.00012		\$ 57.00	\$ 55.00	HDL000019	4	\$ 11.00
1.1351 to 1.510 28.831mm to 38.35mm	XX	.000030	Go 1 5/8	\$ 79.00	\$ 78.00	HDL000024	5	\$ 12.00
	X	.000060	NoGo 3/4	\$ 63.00	\$ 62.00	HDL000024	5	\$ 12.00
	Y	.000090		\$ 61.00	\$ 59.00	HDL000024	5	\$ 12.00
	Z	.00012		\$ 61.00	\$ 59.00	HDL000024	5	\$ 12.00

**TAPERLOCK
CYLINDRICAL PLUG GAGES
CARBIDE**

QUANTITY DISCOUNT 5 OR MORE OF IDENTICAL SIZE LESS 10%

Size	Class	Tolerance	Length	QUANTITY 1		Handle EDP #	Handle #	Handle Price
				Go	Nogo			
.2301 to .365 5.841mm to 9.27mm	XX	.000020	Go 3/4	\$ 166.00	\$ 133.00	HDL000004	1	\$ 10.00
	X	.000040	NoGo 5/16	\$ 155.00	\$ 122.00	HDL000004	1	\$ 10.00
	Y	.000070		\$ 152.00	\$ 119.00	HDL000004	1	\$ 10.00
	Z	.0001		\$ 146.00	\$ 115.00	HDL000004	1	\$ 10.00
.3651 to .510 9.271mm to 12.95mm	XX	.000020	Go 1	\$ 175.00	\$ 152.00	HDL000009	2	\$ 10.00
	X	.000040	NoGo 3/8	\$ 160.00	\$ 142.00	HDL000009	2	\$ 10.00
	Y	.000070		\$ 156.00	\$ 140.00	HDL000009	2	\$ 10.00
	Z	.0001		\$ 153.00	\$ 134.00	HDL000009	2	\$ 10.00
.5101 to .825 12.951mm to 20.96mm	XX	.000020	Go 1 1/4	\$ 235.00	\$ 195.00	HDL000014	3	\$ 10.00
	X	.000040	NoGo 1/2	\$ 211.00	\$ 173.00	HDL000014	3	\$ 10.00
	Y	.000070		\$ 207.00	\$ 166.00	HDL000014	3	\$ 10.00
	Z	.0001		\$ 201.00	\$ 161.00	HDL000014	3	\$ 10.00
.8251 to 1.135 20.961mm to 28.83mm	XX	.000030	Go 1 1/2	\$ 321.00	\$ 259.00	HDL000019	4	\$ 11.00
	X	.000060	NoGo 5/8	\$ 282.00	\$ 225.00	HDL000019	4	\$ 11.00
	Y	.000090		\$ 272.00	\$ 216.00	HDL000019	4	\$ 11.00
	Z	.00012		\$ 267.00	\$ 212.00	HDL000019	4	\$ 11.00
1.1351 to 1.510 28.831mm to 38.35mm	XX	.000030	Go 1 5/8	\$ 431.00	\$ 358.00	HDL000024	5	\$ 12.00
	X	.000060	NoGo 3/4	\$ 392.00	\$ 325.00	HDL000024	5	\$ 12.00
	Y	.000090		\$ 387.00	\$ 316.00	HDL000024	5	\$ 12.00
	Z	.00012		\$ 381.00	\$ 313.00	HDL000024	5	\$ 12.00

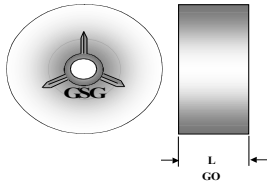

**TRILOCK
CYLINDRICAL PLUG GAGES
STEEL**

All Cylindrical Trilock plug gages are manufactured to ASME/ANSI B47.1 AGD standard and ASME/ANSI B89.1.5 standard.
Gaging surface is hardened to Rc 60-62.

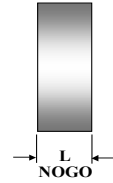

CHROME add 30%

QUANTITY DISCOUNT 5 OR MORE OF IDENTICAL SIZE LESS 10%

Size	Class	Tolerance	Length	QUANTITY 1		Handle EDP #	Handle #	Handle Price
				Go	Nogo			
.760 to .947 19.301mm to 24.05mm	XX	See Chart	Go 1 1/4	\$ 84.00	\$ 83.00	HDL000007	2 1/2	\$ 13.00
	X		NoGo 3/4	\$ 65.00	\$ 65.00	HDL000007	2 1/2	\$ 13.00
	Y			\$ 62.00	\$ 61.00	HDL000007	2 1/2	\$ 13.00
	Z			\$ 62.00	\$ 61.00	HDL000007	2 1/2	\$ 13.00
.9471 to 1.135 24.051mm to 28.83mm	XX	.000030	Go 1 3/8	\$ 87.00	\$ 84.00	HDL000013	3 1/2	\$ 13.00
	X	.000060	NoGo 3/4	\$ 68.00	\$ 65.00	HDL000013	3 1/2	\$ 13.00
	Y	.000090		\$ 64.00	\$ 62.00	HDL000013	3 1/2	\$ 13.00
	Z	.00012		\$ 64.00	\$ 62.00	HDL000013	3 1/2	\$ 13.00
1.1351 to 1.510 28.831mm to 38.35mm	XX	.000030	Go 1 1/2	\$ 87.00	\$ 85.00	HDL000018	4 1/2	\$ 13.00
	X	.000060	NoGo 3/4	\$ 68.00	\$ 67.00	HDL000018	4 1/2	\$ 13.00
	Y	.000090		\$ 65.00	\$ 64.00	HDL000018	4 1/2	\$ 13.00
	Z	.00012		\$ 65.00	\$ 64.00	HDL000018	4 1/2	\$ 13.00
1.5101 to 2.010 38.351mm to 51.05mm	XX	.000040	Go 1 7/8	\$ 115.00	\$ 111.00	HDL000023	5 1/2	\$ 16.00
	X	.000080	NoGo 7/8	\$ 89.00	\$ 85.00	HDL000023	5 1/2	\$ 16.00
	Y	.00012		\$ 84.00	\$ 82.00	HDL000023	5 1/2	\$ 16.00
	Z	.00016		\$ 84.00	\$ 82.00	HDL000023	5 1/2	\$ 16.00
2.0101 to 2.510 51.051mm to 63.75mm	XX	.000040	Go 2	\$ 139.00	\$ 123.00	HDL000028	6	\$ 16.00
	X	.000080	NoGo 7/8	\$ 102.00	\$ 95.00	HDL000028	6	\$ 16.00
	Y	.00012		\$ 97.00	\$ 90.00	HDL000028	6	\$ 16.00
	Z	.00016		\$ 97.00	\$ 90.00	HDL000028	6	\$ 16.00
2.5101 to 3.010 63.751mm to 76.45mm	XX	.000050	Go 2	\$ 162.00	\$ 139.00	HDL000032	7	\$ 17.00
	X	.0001	NoGo 1	\$ 109.00	\$ 99.00	HDL000032	7	\$ 17.00
	Y	.00015		\$ 100.00	\$ 91.00	HDL000032	7	\$ 17.00
	Z	.0002		\$ 100.00	\$ 91.00	HDL000032	7	\$ 17.00
3.0101 to 3.510 76.451mm to 89.15mm	XX	.000050	Go 2	\$ 236.00	\$ 186.00	HDL000032	7	\$ 17.00
	X	.0001	NoGo 1	\$ 182.00	\$ 143.00	HDL000032	7	\$ 17.00
	Y	.00015		\$ 175.00	\$ 136.00	HDL000032	7	\$ 17.00
	Z	.0002		\$ 175.00	\$ 136.00	HDL000032	7	\$ 17.00
3.5101 to 4.010 89.151mm to 101.85mm	XX	.000050	Go 2 1/8	\$ 246.00	\$ 191.00	HDL000032	7	\$ 17.00
	X	.0001	NoGo 1	\$ 188.00	\$ 147.00	HDL000032	7	\$ 17.00
	Y	.00015		\$ 180.00	\$ 139.00	HDL000032	7	\$ 17.00
	Z	.0002		\$ 180.00	\$ 139.00	HDL000032	7	\$ 17.00
4.0101 to 4.510 101.851mm to 114.55mm	XX	.000050	Go 2 1/8	\$ 278.00	\$ 213.00	HDL000032	7	\$ 17.00
	X	.0001	NoGo 1	\$ 214.00	\$ 164.00	HDL000032	7	\$ 17.00
	Y	.00015		\$ 203.00	\$ 155.00	HDL000032	7	\$ 17.00
	Z	.0002		\$ 203.00	\$ 155.00	HDL000032	7	\$ 17.00
4.5101 to 5.010 114.551mm to 127.25mm	XX	.000065	Go 2 1/8	\$ 322.00	\$ 238.00	HDL000032	7	\$ 17.00
	X	.00013	NoGo 1	\$ 248.00	\$ 174.00	HDL000032	7	\$ 17.00
	Y	.00019		\$ 236.00	\$ 164.00	HDL000032	7	\$ 17.00
	Z	.00025		\$ 236.00	\$ 164.00	HDL000032	7	\$ 17.00
5.0101 to 5.510 127.251mm to 139.95mm	XX	.000065	Go 2 1/8	\$ 329.00	\$ 277.00	HDL000032	7	\$ 17.00
	X	.00013	NoGo 1	\$ 254.00	\$ 180.00	HDL000032	7	\$ 17.00
	Y	.00019		\$ 242.00	\$ 167.00	HDL000032	7	\$ 17.00
	Z	.00025		\$ 242.00	\$ 167.00	HDL000032	7	\$ 17.00
5.5101 to 6.010 139.951mm to 152.65mm	XX	.000065	Go 2 1/8	\$ 342.00	\$ 312.00	HDL000032	7	\$ 17.00
	X	.00013	NoGo 1	\$ 264.00	\$ 215.00	HDL000032	7	\$ 17.00
	Y	.00019		\$ 251.00	\$ 202.00	HDL000032	7	\$ 17.00
	Z	.00025		\$ 251.00	\$ 202.00	HDL000032	7	\$ 17.00
6.0101 to 6.510 152.651mm to 165.35mm	XX	.000065	Go 2 1/8	\$ 355.00	\$ 340.00	HDL000032	7	\$ 17.00
	X	.00013	NoGo 1	\$ 275.00	\$ 234.00	HDL000032	7	\$ 17.00
	Y	.00019		\$ 262.00	\$ 222.00	HDL000032	7	\$ 17.00
	Z	.00025		\$ 262.00	\$ 222.00	HDL000032	7	\$ 17.00
6.5101 to 7.010 165.351mm to 178.05mm	XX	.000080	Go 2 1/8	\$ 541.00	\$ 351.00	HDL000032	7	\$ 17.00
	X	.00016	NoGo 1	\$ 417.00	\$ 255.00	HDL000032	7	\$ 17.00
	Y	.00024		\$ 398.00	\$ 241.00	HDL000032	7	\$ 17.00
	Z	.00032		\$ 398.00	\$ 241.00	HDL000032	7	\$ 17.00
7.0101 to 7.510 178.051mm to 190.75mm	XX	.000080	Go 2 1/8	\$ 558.00	\$ 379.00	HDL000032	7	\$ 17.00
	X	.00016	NoGo 1	\$ 429.00	\$ 280.00	HDL000032	7	\$ 17.00
	Y	.00024		\$ 409.00	\$ 271.00	HDL000032	7	\$ 17.00
	Z	.00032		\$ 409.00	\$ 271.00	HDL000032	7	\$ 17.00
7.5101 to 8.010 190.751 to 203.45mm	XX	.000080	Go 2 1/8	\$ 586.00	\$ 413.00	HDL000032	7	\$ 17.00
	X	.00016	NoGo 1	\$ 452.00	\$ 311.00	HDL000032	7	\$ 17.00
	Y	.00024		\$ 429.00	\$ 301.00	HDL000032	7	\$ 17.00
	Z	.00032		\$ 429.00	\$ 301.00	HDL000032	7	\$ 17.00

**TRILOCK
CYLINDRICAL PLUG GAGES
CARBIDE**

QUANTITY DISCOUNT 5 OR MORE OF IDENTICAL SIZE LESS 10%

Size	Class	Tolerance	Length	QUANTITY 1		Handle EDP #	Handle #	Handle Price
				Go	Nogo			
.760 to .825 19.301mm to 20.96mm	XX	.00002	Go 1 1/4	\$ 364.00	\$ 285.00	HDL000007	2 1/2	\$ 13.00
	X	.00004	NoGo 3/4	\$ 326.00	\$ 252.00	HDL000007	2 1/2	\$ 13.00
	Y	.000070		\$ 313.00	\$ 245.00	HDL000007	2 1/2	\$ 13.00
	Z	.0001		\$ 305.00	\$ 236.00	HDL000007	2 1/2	\$ 13.00
.8251 to .947 20.961mm to 24.05mm	XX	.000030	Go 1 1/4	\$ 407.00	\$ 327.00	HDL000007	2 1/2	\$ 13.00
	X	.000060	NoGo 3/4	\$ 356.00	\$ 287.00	HDL000007	2 1/2	\$ 13.00
	Y	.000090		\$ 344.00	\$ 269.00	HDL000007	2 1/2	\$ 13.00
	Z	.00012		\$ 338.00	\$ 261.00	HDL000007	2 1/2	\$ 13.00
.9471 to 1.135 24.051mm to 28.82mm	XX	.000030	Go 1 3/8	\$ 454.00	\$ 365.00	HDL000013	3 1/2	\$ 13.00
	X	.000060	NoGo 3/4	\$ 402.00	\$ 331.00	HDL000013	3 1/2	\$ 13.00
	Y	.000090		\$ 389.00	\$ 316.00	HDL000013	3 1/2	\$ 13.00
	Z	.00012		\$ 381.00	\$ 309.00	HDL000013	3 1/2	\$ 13.00
1.1351 to 1.344 28.821mm to 34.13mm	XX	.000030	Go 1 1/2	\$ 509.00	\$ 427.00	HDL000018	4 1/2	\$ 13.00
	X	.000060	NoGo 3/4	\$ 466.00	\$ 385.00	HDL000018	4 1/2	\$ 13.00
	Y	.000090		\$ 455.00	\$ 378.00	HDL000018	4 1/2	\$ 13.00
	Z	.00012		\$ 447.00	\$ 369.00	HDL000018	4 1/2	\$ 13.00
1.3441 to 1.510 34.131mm to 38.35mm	XX	.000030	Go 1 1/2	\$ 565.00	\$ 508.00	HDL000018	4 1/2	\$ 13.00
	X	.00060	NoGo 3/4	\$ 514.00	\$ 459.00	HDL000018	4 1/2	\$ 13.00
	Y	.000090		\$ 506.00	\$ 447.00	HDL000018	4 1/2	\$ 13.00
	Z	.00012		\$ 498.00	\$ 440.00	HDL000018	4 1/2	\$ 13.00
1.5101 to 1.760 38.351mm to 44.70mm	XX	.000040	Go 1 7/8	\$ 718.00	\$ 628.00	HDL000023	5 1/2	\$ 16.00
	X	.000080	NoGo 7/8	\$ 649.00	\$ 567.00	HDL000023	5 1/2	\$ 16.00
	Y	.00012		\$ 640.00	\$ 552.00	HDL000023	5 1/2	\$ 16.00
	Z	.00016		\$ 633.00	\$ 545.00	HDL000023	5 1/2	\$ 16.00

**PROGRESSIVE
CYLINDRICAL PLUG GAGES
STEEL**

CHROME ADD 30%

QUANTITY DISCOUNT 5 OR MORE OF IDENTICAL SIZE LESS 10%

Size	Class	Tolerance	Length	QUANTITY		Handle EDP #	Handle #	Handle Price
				1				
.105 to .150 2.671mm to 3.81mm	XX	.000020	Go 3/8	\$ 112.00	HDL000002	0	\$ 11.00	
	X	.000040	NoGo 7/32	\$ 102.00	HDL000002	0	\$ 11.00	
	Y	.000070		\$ 95.00	HDL000002	0	\$ 11.00	
	Z	.0001		\$ 95.00	HDL000002	0	\$ 11.00	
.1501 to .230 3.811mm to 5.84mm	XX	.000020	Go 13/32	\$ 110.00	HDL000003	0	\$ 11.00	
	X	.000040	NoGo 9/32	\$ 95.00	HDL000003	0	\$ 11.00	
	Y	.000070		\$ 91.00	HDL000003	0	\$ 11.00	
	Z	.0001		\$ 91.00	HDL000003	0	\$ 11.00	
.2301 to .365 5.841mm to 9.27mm	XX	.000020	Go 3/4	\$ 112.00	HDL000004	1	\$ 10.00	
	X	.000040	NoGo 5/16	\$ 97.00	HDL000004	1	\$ 10.00	
	Y	.000070		\$ 92.00	HDL000004	1	\$ 10.00	
	Z	.0001		\$ 92.00	HDL000004	1	\$ 10.00	
.3651 to .510 9.271mm to 12.95mm	XX	.000020	Go 1	\$ 114.00	HDL000009	2	\$ 10.00	
	X	.000040	NoGo 3/8	\$ 100.00	HDL000009	2	\$ 10.00	
	Y	.000070		\$ 93.00	HDL000009	2	\$ 10.00	
	Z	.0001		\$ 93.00	HDL000009	2	\$ 10.00	
.5101 to .825 12.951mm to 20.96mm	XX	.000020	Go 1 1/4	\$ 122.00	HDL000014	3	\$ 10.00	
	X	.000040	NoGo 1/2	\$ 109.00	HDL000014	3	\$ 10.00	
	Y	.000070		\$ 100.00	HDL000014	3	\$ 10.00	
	Z	.0001		\$ 100.00	HDL000014	3	\$ 10.00	
.8251 to 1.135 20.961mm to 28.83mm	XX	.000030	Go 1 3/8	\$ 136.00	HDL000019	4	\$ 11.00	
	X	.000060	GoNo 5/8	\$ 116.00	HDL000019	4	\$ 11.00	
	Y	.000090		\$ 112.00	HDL000019	4	\$ 11.00	
	Z	.00012		\$ 112.00	HDL000019	4	\$ 11.00	
1.1351 to 1.510 28.831mm to 38.35mm	XX	.000030	Go 1 1/2	\$ 155.00	HDL000024	5	\$ 24.00	
	X	.000060	GoNo 3/4	\$ 121.00	HDL000024	5	\$ 24.00	
	Y	.000090		\$ 113.00	HDL000024	5	\$ 24.00	
	Z	.00012		\$ 113.00	HDL000024	5	\$ 24.00	

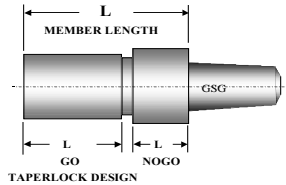

QUANTITY DISCOUNT 5 OR MORE OF IDENTICAL SIZE LESS 10%

Size	Class	Tolerance	Length	QUANTITY		Handle EDP #	Handle #	Handle Price
				1				
1.5101 to 2.010 38.351mm to 51.05mm	XX	.000040	Go 1 7/8	\$ 212.00	HDL000022	5 1/2 SE	\$ 16.00	
	X	.000080	NoGo 7/8	\$ 192.00	HDL000022	5 1/2 SE	\$ 16.00	
	Y	.00012		\$ 183.00	HDL000022	5 1/2 SE	\$ 16.00	
	Z	.00016		\$ 183.00	HDL000022	5 1/2 SE	\$ 16.00	
2.0101 to 2.510 51.051mm to 63.75mm	XX	.000040	Go 2	\$ 297.00	HDL000027	6 SE	\$ 16.00	
	X	.000080	NoGo 7/8	\$ 225.00	HDL000027	6 SE	\$ 16.00	
	Y	.00012		\$ 215.00	HDL000027	6 SE	\$ 16.00	
	Z	.00016		\$ 215.00	HDL000027	6 SE	\$ 16.00	
2.5101 to 3.010 63.751mm to 76.45mm	XX	.000050	Go 2	\$ 333.00	HDL000031	7 SE	\$ 17.00	
	X	.0001	NoGo 7/8	\$ 254.00	HDL000031	7 SE	\$ 17.00	
	Y	.00015		\$ 232.00	HDL000031	7 SE	\$ 17.00	
	Z	.0002		\$ 232.00	HDL000031	7 SE	\$ 17.00	
3.0101 to 3.510 76.451mm to 89.15mm	XX	.000050	Go 2	\$ 396.00	HDL000031	7 SE	\$ 17.00	
	X	.0001	NoGo 7/8	\$ 301.00	HDL000031	7 SE	\$ 17.00	
	Y	.00015		\$ 261.00	HDL000031	7 SE	\$ 17.00	
	Z	.0002		\$ 261.00	HDL000031	7 SE	\$ 17.00	
3.5101 to 4.010 89.151mm to 101.85mm	XX	.000050	Go 2 1/8	\$ 462.00	HDL000031	7 SE	\$ 17.00	
	X	.0001	NoGo 7/8	\$ 347.00	HDL000031	7 SE	\$ 17.00	
	Y	.00015		\$ 303.00	HDL000031	7 SE	\$ 17.00	
	Z	.0002		\$ 303.00	HDL000031	7 SE	\$ 17.00	
4.0101 to 4.510 101.851mm to 114.55mm	XX	.000050	Go 2 1/8	\$ 526.00	HDL000031	7 SE	\$ 17.00	
	X	.0001	NoGo 7/8	\$ 396.00	HDL000031	7 SE	\$ 17.00	
	Y	.00015		\$ 349.00	HDL000031	7 SE	\$ 17.00	
	Z	.0002		\$ 349.00	HDL000031	7 SE	\$ 17.00	

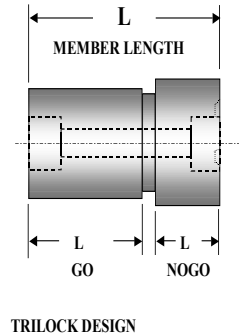



CYLINDRICAL TAPER GAGES

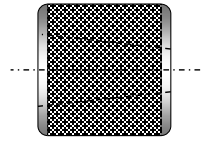

NATIONAL MACHINE TAPERS

Taper #	Large End	Small End	Length	Price Each	
				Plug	Ring
5	.500	.2995	.6875	\$ 526.00	\$ 843.00
10	.625	.3698	.8750	\$ 410.00	\$ 737.00
15	.750	.4401	1.0625	\$ 410.00	\$ 737.00
20	.875	.4922	1.3125	\$ 410.00	\$ 696.00
25	1.000	.5443	1.5625	\$ 430.00	\$ 696.00
30	1.250	.7031	1.8750	\$ 472.00	\$ 737.00

Taper #	Large End	Small End	Length	Price Each	
				Plug	Ring
35	1.500	.8438	2.2500	\$ 536.00	\$ 783.00
40	1.750	1.0026	2.5625	\$ 591.00	\$ 828.00
45	2.250	1.2839	3.3125	\$ 644.00	\$ 888.00
50	2.750	1.5833	4.0000	\$ 700.00	\$ 945.00
55	3.500	1.9870	5.1875	\$ 737.00	\$ 1,008.00
60	4.250	2.3906	6.3750	\$ 764.00	\$ 1,073.00

JARNO TAPERS - W/O TANG .6000" TPF

Taper #	Large End	Small End	Length	Price Each	
				Plug	Ring
1	.125	.100	.500	\$ 526.00	\$ 843.00
2	.250	.200	1.00	\$ 526.00	\$ 843.00
3	.375	.300	1.50	\$ 581.00	\$ 737.00
4	.500	.400	2.00	\$ 581.00	\$ 778.00
5	.625	.500	2.50	\$ 430.00	\$ 761.00
6	.750	.600	3.00	\$ 452.00	\$ 778.00
7	.875	.700	3.50	\$ 475.00	\$ 737.00
8	1.000	.800	4.00	\$ 516.00	\$ 802.00
9	1.125	.900	4.50	\$ 548.00	\$ 843.00
10	1.250	1.000	5.00	\$ 574.00	\$ 876.00

Taper #	Large End	Small End	Length	Price Each	
				Plug	Ring
11	1.375	1.100	5.50	\$ 606.00	\$ 934.00
12	1.500	1.200	6.00	\$ 721.00	\$ 1,007.00
13	1.625	1.300	6.50	\$ 754.00	\$ 1,064.00
14	1.750	1.400	7.00	\$ 786.00	\$ 1,106.00
15	1.875	1.500	7.50	\$ 852.00	\$ 1,213.00
16	2.000	1.600	8.00	\$ 974.00	\$ 1,386.00
17	2.125	1.700	8.50	\$ 1,084.00	\$ 1,472.00
18	2.250	1.800	9.00	\$ 1,148.00	\$ 1,494.00
19	2.375	1.900	9.50	\$ 1,176.00	\$ 1,598.00
20	2.500	2.000	10.00	\$ 1,235.00	\$ 1,683.00

MORSE TAPERS

Taper #	Large End	Small End	Length	TPF	Plug Price		Ring Price	
					W/O Tang	W/Tang	W/O Tang	W/Tang
0	.3561	.2520	2.00	.62460	\$ 581.00	\$ 726.00	\$ 778.00	\$ 973.00
1	.4750	.3690	2 1/8	.59858	\$ 581.00	\$ 726.00	\$ 827.00	\$ 1,034.00
2	.7000	.5720	2 9/16	.59941	\$ 452.00	\$ 565.00	\$ 778.00	\$ 973.00
3	.9380	.7780	3 3/16	.60235	\$ 476.00	\$ 595.00	\$ 737.00	\$ 922.00
4	1.2310	1.0200	4 1/16	.62326	\$ 548.00	\$ 685.00	\$ 819.00	\$ 1,024.00
4 1/2	1.500	1.2660	4 1/2	.62400	\$ 548.00	\$ 685.00	\$ 901.00	\$ 1,260.00
5	1.7480	1.4750	5 3/16	.63151	\$ 696.00	\$ 870.00	\$ 1,064.00	\$ 1,330.00
6	2.4940	2.1160	7 1/4	.62565	\$ 926.00	\$ 1,158.00	\$ 1,262.00	\$ 1,578.00
7	3.2700	2.7500	10	.62400	\$ 1,332.00	\$ 1,665.00	\$ 1,514.00	\$ 1,983.00

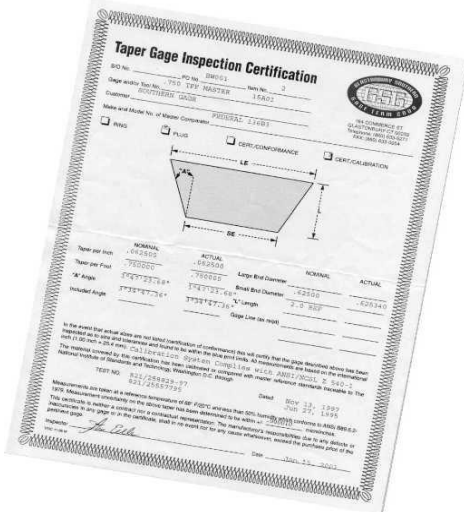

All Standard Tapers manufacture to ASME/ANSI B5.10 class Z unless otherwise specified.

- Cat V Flange Tapers
- Medical Luer Tapers
- Steep Machine Tapers

Other Tapers available from GSG

Certification available see page 2 for price.

REQUEST FOR QUOTE

SPECIAL TAPERS

Please furnish what information you have on your special gaging requirements. Mark up drawing(s) to show any additional characteristics.

From: _____
Name: _____
Company: _____
Phone: _____
Fax: _____



FAX TO: 1-860-537-4332
EMAIL TO: SALES@GG.GSGAGE.COM

Note: All tapers are held to +/- .0001 at large end diameter.
 Small end diameter reference only.
 Taper tolerance +/- .000050 inch per inch.
 Please specify if your requirements are different.

Mark Size: _____
 Tool #: _____

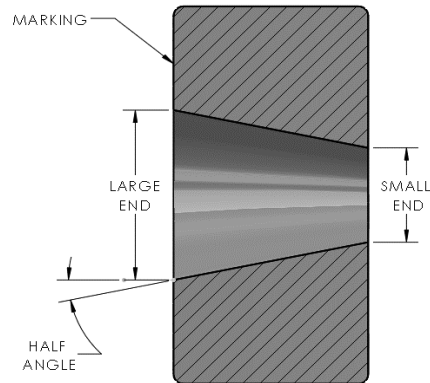

Steps at large end or small end (optional) _____

RING GAGE

Diameter @ Small End: _____
 Diameter @ Large End: _____
 Overall Length of Taper: _____

Taper/Ft: _____
 Taper/In: _____
 Taper Tol: _____ Inch/inch
 1/2 Angle: _____
 Included Angle: _____

Mark Size: _____
 Tool #: _____

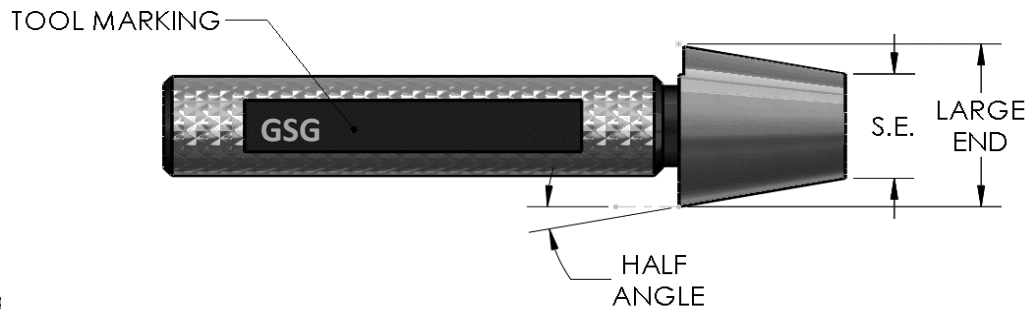

Steps at larg _____

PLUG GAGE

Diameter @ Small End: _____
 Diameter @ Large End: _____
 Overall Length of Taper: _____

Taper/Ft: _____
 Taper/In: _____
 Taper Tol: _____ Inch/inch
 1/2 Angle: _____
 Included Angle: _____



For interactive quote forms online, click on this code

SURVEILLANCE MASTERS

Micrometer Set Masters (except 01-1) are chrome plated to reduce wear and prevent rust.

MICROMETER SET MASTERS

Model #	Price
01-1E (English)	\$ 431.00
01-1M (Metric)	\$ 431.00
Certification	\$ 90.00
Storage Case	(included)

.100" to 1.00" with .512" and .762" for offset
01-1 is Stainless Steel to reduce wear and prevent rust.
Hardened, stabilized, ground & lapped to +/- .0001".



Model #	Price
16-1 (English)	\$ 857.00
16-1M (Metric)	\$ 857.00
Certification	\$ 90.00
Storage Case	\$ 240.00

1.00" to 6.00" diameter in one inch increments
25mm to 150mm diameter in 25mm increments.
Case hardened, stabilized, ground & lapped to +/- .0001"
or to +/- .0025mm.



Model #	Price
16-1/2E (English)	\$ 1,105.00
16-1/2M (Metric)	\$ 1,105.00
Certification	\$ 180.00
Storage Case	\$ 360.00

1/2" to 6.00" diameter in 1/2 inch increments.
12.5mm to 150mm diameter in 12.5mm increments
Case hardened, stabilized, ground to +/- .0001"
or +/- .0025mm.



Model #	Price
112E (English)	\$ 2,015.00
112M (Metric)	\$ 2,015.00
Certification	\$ 220.00
Storage Case	\$ 360.00

1.00" to 12.00" diameter in one inch increments.
25mm to 300mm diameter in 25mm increments.
Case hardened, stabilized, ground to +/- .0001"
or +/- .0025mm.



VERNIER CALIPER MASTERS

Model #	Price
VC-1E (English)	\$ 498.00
VC-1M (Metric)	\$ 498.00
Certification	\$ 90.00
Storage Case	\$ 40.00

1.00" to 6.00" in one inch increments for outside jaws, +/- .0002".
1/2 to 4 1/2" inside jaws
25mm to 150mm in 25mm increments for outside jaws, +/- .005mm
12.5 to 112.5mm for inside jaws.
Lapped Steps / No Chrome
(Larger models available, contact factory.)



Scan the code to be taken to our technical booklet for more information on our surveillance products

SURVEILLANCE MASTERS & ARTIFACTS

ADM DEPTH MIC MASTER

Model #	Price
ADM-E(English)	\$ 2,074.00
ADM-E Riser (increase depth range x 2)	\$ 460.00
ADM-M(Metric)	\$ 2,074.00
ADM-M Riser (increase depth range x 2)	\$ 460.00
Certification	\$ 225.00

Depth's obtainable w/out Riser
 .500" to 5.50" in one inch steps, +/- .0001"
 12.5mm to 137.5mm in 25mm steps, +/- .0025mm.

Depth's obtainable w/Riser
 .500" to 11.50" in one inch steps +/- .0002
 12.5mm to 287.5mm in 25mm steps, +/- .005mm.



ADM Riser
(optional)

ADM

GSG CMM QUIKCHEK'S

QUIKCHEK is your mechanical assurance of CMM accuracy. All QUIKCHEKs are 440c stainless steel hardened to Rc 60-62. Stress relieved & triple stabilized. Supplied with certification and Aluminum case. Special sizes available, contact factory.

NEW ITEM

Model #	Price
5 inch	\$ 3,990.00
8 inch	\$ 4,395.00
16 inch	\$ 9,845.00

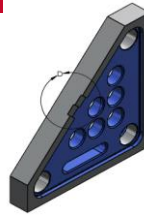

(shown) 5.00" QuikChek with depth notches



(shown) 8.00" & 16.00" QuikChek Models



Click on the code for more product info and video

GSG GEOCHEK CIRCULAR ROUNDNESS MASTER

Model #	Price
GC-1	\$ 1,490.00

*Cases available on pg. 42

Master for circular geometry systems. Precision Test & Set-up master. All Geometric Cheks are supplied with complete certs. Certs includes roundness & concentricity in three planes, perpendicularity (squareness) check & parallelism. All GeoChek's are 440c stainless steel
 Product Dimensions: 3.500" O.D x 2.500" I.D. x 4.500" Long



GSG Z-AXIS MASTERS

Model #		Price
LX-1	+/- .00005	\$ 757.00
GX-1	+/- .0001	\$ 680.00

Master for calibrating the Z axis on your optical CMM. Certified to the nearest .000010". LX-1 Lapped base with mirror finish. GX-1 Ground finish base for less reflection. Supplied with certification & storage cases. All Z-Axis Cheks are 440c stainless steel

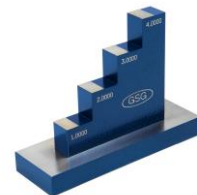

Optional Wood Storage Boxes by Gerstner™

NEW ITEM

The ultimate protection against moisture and damage by one of the oldest cabinet makers in America. For over 100 years, Gerstner & Son has been manufacturing tool chest for tool, die & gage makers alike.



Product	Price
5.00" QuikChek	\$ 240.00
8.00" QuikChek	\$ 320.00
ADM Depth Mic Check	\$ 265.00
ADM w/optional riser	\$ 360.00



***Please see page 42 of our catalog for more protective cases.



Scan the code to be taken to our technical booklet for more information on our surveillance products

MASTER SETTING PLUGS

CLASS "W" FULL FORM
FOR TRI-ROLL AND STC COMPARATORS

INCH 3A (Go Basic)				Handle	Handle	Handle
Size	Length	EDP #	Price	EDP #	#	Price
0-80 (.060) UNF	1/4	TPS100825	\$ 114.00	HDL000001	000	\$ 11.00
1-64 (.073) UNC	1/4	TPS100826	\$ 114.00	HDL000001	000	\$ 11.00
1-72 (.073) UNF	1/4	TPS100827	\$ 114.00	HDL000001	000	\$ 11.00
2-56 (.086) UNC	1/4	TPS100832	\$ 114.00	HDL000001	000	\$ 11.00
2-64 (.086) UNF	1/4	TPS100833	\$ 114.00	HDL000001	000	\$ 11.00
3-48 (.099) UNC	1/4	TPS100834	\$ 111.00	HDL000001	000	\$ 11.00
3-56 (.099) UNF	1/4	TPS100835	\$ 111.00	HDL000001	000	\$ 11.00
4-40 (.112) UNC	5/16	TPS100848	\$ 100.00	HDL000002	00	\$ 11.00
4-48 (.112) UNF	5/16	TPS100849	\$ 100.00	HDL000002	00	\$ 11.00
5-40 (.125) UNC	5/16	TPS100856	\$ 100.00	HDL000002	00	\$ 11.00
5-44 (.125) UNF	5/16	TPS100858	\$ 100.00	HDL000002	00	\$ 11.00
6-32 (.138) UNC	5/16	TPS100864	\$ 97.00	HDL000002	00	\$ 11.00
6-40 (.138) UNF	5/16	TPS100866	\$ 97.00	HDL000002	00	\$ 11.00
8-32 (.164) UNC	13/32	TPS100872	\$ 97.00	HDL000003	0	\$ 11.00
8-36 (.164) UNF	13/32	TPS100874	\$ 97.00	HDL000003	0	\$ 11.00
10-24 (.190) UNC	13/32	TPS100880	\$ 97.00	HDL000003	0	\$ 11.00
10-32 (.190) UNF	13/32	TPS100882	\$ 97.00	HDL000003	0	\$ 11.00
12-24 (.216) UNC	13/32	TPS100888	\$ 104.00	HDL000003	0	\$ 11.00
12-28 (.216) UNF	13/32	TPS100890	\$ 104.00	HDL000003	0	\$ 11.00
1/4-20 UNF	1/2	TPS100899	\$ 86.00	HDL000004	1	\$ 10.00
1/4-28 UNC	1/2	TPS100902	\$ 86.00	HDL000004	1	\$ 10.00
5/16-18 UNC	1/2	TPS100913	\$ 86.00	HDL000004	1	\$ 10.00
5/16-24 UNC	1/2	TPS100914	\$ 86.00	HDL000004	1	\$ 10.00
3/8-16 UNC	3/4	TPS100924	\$ 86.00	HDL000009	2	\$ 10.00
3/8-24 UNF	3/4	TPS100926	\$ 86.00	HDL000009	2	\$ 10.00
7/16-14 UNC	3/4	TPS100936	\$ 86.00	HDL000009	2	\$ 10.00
7/16-20 UNF	3/4	TPS100938	\$ 86.00	HDL000009	2	\$ 10.00
1/2-13 UNC	3/4	TPS100948	\$ 93.00	HDL000009	2	\$ 10.00
1/2-20 UNF	3/4	TPS100950	\$ 93.00	HDL000009	2	\$ 10.00
9/16-12 UNC	7/8	TPS100960	\$ 104.00	HDL000014	3	\$ 10.00
9/16-18 UNC	7/8	TPS100962	\$ 104.00	HDL000014	3	\$ 10.00
5/8-11 UNC	7/8	TPS100972	\$ 104.00	HDL000014	3	\$ 10.00
5/8-18 UNC	7/8	TPS100974	\$ 104.00	HDL000014	3	\$ 10.00
3/4-10 UNC	7/8	TPS100988	\$ 121.00	HDL000014	3	\$ 10.00
3/4-16 UNC	7/8	TPS100990	\$ 121.00	HDL000014	3	\$ 10.00
7/8-9 UNC	1	TPS101004	\$ 154.00	HDL000019	4	\$ 11.00
7/8-14 UNC	1	TPS101006	\$ 154.00	HDL000019	4	\$ 11.00
1"-8 UNC	1	TPS101020	\$ 167.00	HDL000019	4	\$ 11.00
1"-12 UNC	1	TPS101022	\$ 167.00	HDL000019	4	\$ 11.00
1"-14 UNC	1	TPS101024	\$ 167.00	HDL000019	4	\$ 11.00
1 1/8-7 UNC	1	TPS101044	\$ 198.00	HDL000019	4	\$ 11.00
1 1/8-12 UNC	1	TPS101046	\$ 198.00	HDL000019	4	\$ 11.00
1 1/4-7 UNC	1 1/4	TPS101064	\$ 217.00	HDL000024	5	\$ 12.00
1 1/4-12 UNC	1	TPS101066	\$ 217.00	HDL000024	5	\$ 12.00
1 3/8-6 UNC	1 1/4	TPS101084	\$ 249.00	HDL000024	5	\$ 12.00
1 3/8-12 UNC	1	TPS101086	\$ 249.00	HDL000024	5	\$ 12.00
1 1/2-6 UNC	1 1/4	TPS101104	\$ 262.00	HDL000024	5	\$ 12.00
1 1/2-12 UNC	1	TPS101106	\$ 240.00	HDL000024	5	\$ 12.00

For Tri-Roll and STC Systems.
Other sizes available, contact factory.

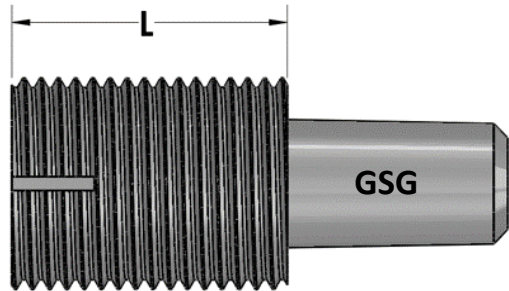

METRIC 6g (Go)				Handle	Handle	Handle
Size	Length	EDP #	Price	EDP#	#	Price
M1.6 x .35	1/4	TPS200251	\$ 134.00	HDL000001	000	\$ 11.00
M2 x 4	1/4	TPS200255	\$ 122.00	HDL000001	000	\$ 11.00
M2.5 x .45	1/4	TPS200259	\$ 122.00	HDL000001	000	\$ 11.00
M3 x .5	5/16	TPS200261	\$ 122.00	HDL000003	00	\$ 11.00
M4 x .7	13/32	TPS200264	\$ 120.00	HDL000003	00	\$ 11.00
M5 x .8	13/32	TPS200268	\$ 120.00	HDL000004	0	\$ 10.00
M6 x 1	1/2	TPS200270	\$ 101.00	HDL000004	1	\$ 10.00
M8 x 1.25	1/2	TPS200286	\$ 101.00	HDL000009	1	\$ 10.00
M10 x 1.5	3/4	TPS200292	\$ 110.00	HDL000009	2	\$ 10.00
M10 x 1.25	3/4	TPS200288	\$ 110.00	HDL000009	2	\$ 10.00
M12 x 1.75	3/4	TPS200310	\$ 114.00	HDL000009	2	\$ 10.00
M12 x 1.25	3/4	TPS200290	\$ 114.00	HDL000009	2	\$ 10.00
M14 x 2	7/8	TPS200312	\$ 128.00	HDL000014	3	\$ 10.00
M14 x 1.5	7/8	TPS200296	\$ 128.00	HDL000014	3	\$ 10.00
M16 x 2	7/8	TPS200314	\$ 154.00	HDL000014	3	\$ 10.00
M20 x 1.5	7/8	TPS200302	\$ 179.00	HDL000019	4	\$ 11.00
M22 x 1.5	1	TPS200304	\$ 190.00	HDL000019	4	\$ 11.00
M24 x 3	1	TPS200334	\$ 213.00	HDL000019	4	\$ 11.00

TRI-ROLL COMPONENTS

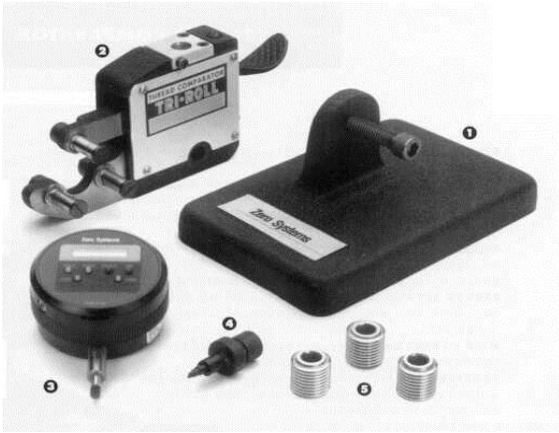

There are 5 components that comprise a complete Tri-Roll system.
To assist you in ordering, we have separated each of the five components into pricing tables with the size range, price and EDP #.

1. Base & Accessories	EDP #	Price
Base	VE0000250	\$ 42.00
Multiple Mounting Bar	VE0000253	\$ 43.00
Dual Frame Base Assembly	VE0000251	\$ 83.00
Aluminum Handle for Hand Held Unit	VE0000252	\$ 51.00

2. Frames					
Frame #	Range-Nominal Size		Roll Length Per Inch	EDP #	Price
	Above	To & Including			
0	.059 (1.5mm)	.073 (1.8mm)	.223	VE0000001	\$ 392.00
1	.073 (1.8mm)	.099 (2.5mm)	.223	VE0000002	\$ 392.00
2	.099 (2.5mm)	.164 (4.2mm)	.223	VE0000003	\$ 399.00
3	.164 (4.2mm)	.313 (7.9mm)	.424	VE0000004	\$ 399.00
4	.313 (7.9mm)	.500 (12.7mm)	.424	VE0000005	\$ 406.00
5	.500 (12.7mm)	.750 (19.0mm)	.626	VE0000006	\$ 406.00
6	.750 (19.0mm)	1.125 (28.5mm)	.931	VE0000007	\$ 426.00
7	1.125 (28.5mm)	1.500 (38.1mm)	.931	VE0000008	\$ 426.00
8	1.500 (38.1mm)	1.875 (47.6mm)	.931	VE0000009	\$ 639.00
9	1.875 (47.6mm)	2.250 (57.1mm)	.931	VE0000010	\$ 678.00
10	2.250 (57.1mm)	2.625 (66.7mm)	.931	VE0000011	\$ 712.00
11	2.625 (66.7mm)	3.000 (76.2mm)	.931	VE0000012	\$ 843.00
12	3.000 (76.2mm)	3.375 (85.7mm)	.931	VE0000013	\$ 902.00

3. Dial Indicator	Graduations	EDP #	Price
	.0001 inch	VE0000254	\$ 212.00
	.00025 inch	VE0000255	\$ 212.00
	0.002mm Metric	VE0000256	\$ 212.00
Electronic Indicator	Price on application		P.O.A.

4. Stop Adjusting Tool	EDP #	Price
	VE0000375	\$ 24.00

GAGING ROLLS

LONG FORM CERTIFICATION \$50

ADD \$60 AND 1 WEEK FOR TYPE 3 J SERIES

SELECTING GAGING ROLLS

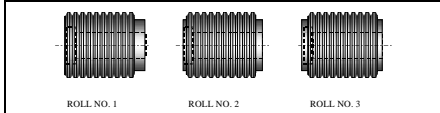

TYPE 3

Full Profile-Functional Diameter Size.

Full ribbed rolls for functional diameter size for pitches coarser than 48 TPI.

(For 48 TPI and finer the ribs locate on alternate threads)

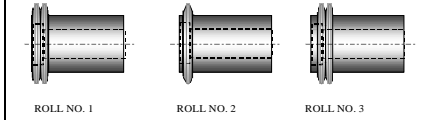

TYPE 4

Cone & Vee-Single Element Pitch Diameter

Two ribs (Vee type) on lower rolls (No. 1 and 3)

One rib (Cone type) on upper roll (No. 2)

Flank contact limited to .1 pitch.



TYPE 5

"Best Wire" Size Radius-Single Element Pitch Diameter

Single ribs only with "Best Wire" size radius for any given pitch (TPI).

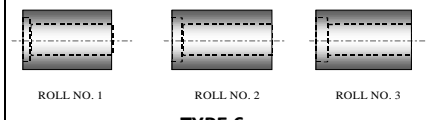

TYPE 6

Plain Rolls-Thread Major Diameter and Plain Cylindrical Parts.

Straight cylindrical rolls for checking diameter and out-of-roundness.

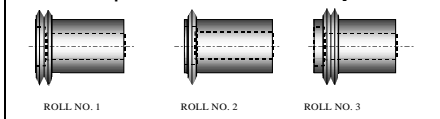

TYPE 7

Minor Diameter

(55 degree included angle)

Two full profile "Vee" rolls (No. 1 and 3)

One full profile "Cone" roll (No. 2).

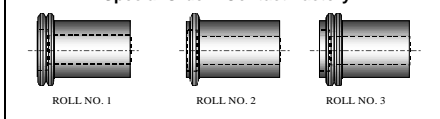

TYPE 8

Lead/Flank Angle

Outside flanks relieved.

One full profile "Cone" roll (No. 2).

5. Rolls		Type 3 Full Profile Functional Size Diameter		Type 4 Cone and Vee Single Element Pitch Diameter		Type 5 "Best Wire" Size Radius Single Element Pitch Diameter	
Size	Used on Frame #	EDP #	Price	EDP #	Price	EDP #	Price
0-80	0	VE000014	\$ 313.00			VE0000102	\$ 191.00
1-64	0	VE0000015	\$ 329.00			VE0000103	\$ 191.00
1-72	0	VE0000016	\$ 329.00			VE0000104	\$ 191.00
2-56	1	VE0000017	\$ 329.00			VE0000105	\$ 191.00
2-64	1	VE0000018	\$ 329.00			VE0000106	\$ 191.00
3-48	1	VE0000019	\$ 329.00			VE0000107	\$ 191.00
3-56	1	VE0000020	\$ 329.00			VE0000108	\$ 191.00
4-40	2	VE0000022	\$ 329.00	VE0000062	\$ 286.00	VE0000110	\$ 191.00
4-48	2	VE0000021	\$ 329.00			VE0000109	\$ 191.00
5-40	2	VE0000023	\$ 329.00	VE0000063	\$ 286.00	VE0000111	\$ 191.00
5-44	2	VE0000024	\$ 329.00	VE0000064	\$ 286.00	VE0000112	\$ 191.00
6-32	2	VE0000025	\$ 329.00	VE0000065	\$ 286.00	VE0000113	\$ 191.00
6-40	2	VE0000026	\$ 329.00	VE0000066	\$ 286.00	VE0000114	\$ 191.00
8-32	2	VE0000027	\$ 329.00	VE0000067	\$ 286.00	VE0000115	\$ 191.00
8-36	2	VE0000028	\$ 329.00	VE0000068	\$ 286.00	VE0000116	\$ 191.00
10-24	3	VE0000029	\$ 329.00	VE0000069	\$ 286.00	VE0000117	\$ 191.00
10-32	3	VE0000030	\$ 329.00	VE0000070	\$ 286.00	VE0000118	\$ 191.00
12-24	3	VE0000031	\$ 329.00	VE0000071	\$ 286.00	VE0000119	\$ 191.00
12-28	3	VE0000032	\$ 329.00	VE0000072	\$ 286.00	VE0000120	\$ 191.00
1/4-20	3	VE0000033	\$ 329.00	VE0000073	\$ 286.00	VE0000121	\$ 191.00
1/4-28	3	VE0000034	\$ 329.00	VE0000074	\$ 286.00	VE0000122	\$ 191.00
5/16-18	3	VE0000035	\$ 329.00	VE0000075	\$ 286.00	VE0000123	\$ 191.00
5/16-24	3	VE0000036	\$ 329.00	VE0000076	\$ 286.00	VE0000124	\$ 191.00
3/8-16	4	VE0000037	\$ 329.00	VE0000077	\$ 286.00	VE0000125	\$ 191.00
3/8-24	4	VE0000038	\$ 329.00	VE0000078	\$ 286.00	VE0000126	\$ 191.00
7/16-14	4	VE0000039	\$ 329.00	VE0000079	\$ 286.00	VE0000127	\$ 191.00
7/16-20	4	VE0000040	\$ 329.00	VE0000080	\$ 286.00	VE0000128	\$ 191.00
1/2-13	4	VE0000041	\$ 329.00	VE0000081	\$ 286.00	VE0000129	\$ 191.00
1/2-20	4	VE0000042	\$ 329.00	VE0000082	\$ 286.00	VE0000130	\$ 191.00
9/16-12	5	VE0000043	\$ 329.00	VE0000083	\$ 286.00	VE0000131	\$ 191.00
9/16-18	5	VE0000044	\$ 329.00	VE0000084	\$ 286.00	VE0000132	\$ 191.00
5/8-11	5	VE0000045	\$ 329.00	VE0000085	\$ 286.00	VE0000133	\$ 191.00
5/8-18	5	VE0000046	\$ 329.00	VE0000086	\$ 286.00	VE0000134	\$ 191.00
3/4-10	5	VE0000047	\$ 329.00	VE0000087	\$ 286.00	VE0000135	\$ 191.00
3/4-16	5	VE0000048	\$ 329.00	VE0000088	\$ 286.00	VE0000136	\$ 191.00
7/8-9	6	VE0000049	\$ 338.00	VE0000089	\$ 322.00	VE0000137	\$ 222.00
7/8-14	6	VE0000050	\$ 338.00	VE0000090	\$ 322.00	VE0000138	\$ 222.00
1"-8	6	VE0000051	\$ 338.00	VE0000091	\$ 322.00	VE0000139	\$ 222.00
1"-12	6	VE0000052	\$ 338.00	VE0000092	\$ 322.00	VE0000140	\$ 222.00
1"-14	6	VE0000053	\$ 338.00	VE0000093	\$ 322.00	VE0000141	\$ 222.00
1 1/8-7	6	VE0000054	\$ 338.00	VE0000094	\$ 322.00	VE0000142	\$ 222.00
1 1/8-12	6	VE0000055	\$ 338.00	VE0000095	\$ 322.00	VE0000143	\$ 222.00
1 1/4-7	7	VE0000056	\$ 338.00	VE0000096	\$ 322.00	VE0000144	\$ 222.00
1 1/4-12	7	VE0000057	\$ 338.00	VE0000097	\$ 322.00	VE0000145	\$ 222.00
1 3/8-6	7	VE0000058	\$ 338.00	VE0000098	\$ 322.00	VE0000146	\$ 222.00
1 3/8-12	7	VE0000059	\$ 338.00	VE0000099	\$ 322.00	VE0000147	\$ 222.00
1 1/2-6	7	VE0000060	\$ 338.00	VE0000100	\$ 322.00	VE0000148	\$ 222.00
1 1/2-12	7	VE0000061	\$ 338.00	VE0000101	\$ 322.00	VE0000149	\$ 222.00

METRIC

5. Rolls		Type 3 Full Profile Functional Size Diameter		Type 4 Cone and Vee Single Element Pitch Diameter		Type 5 "Best Wire" Size Radius Single Element Pitch Diameter	
Size	Used on Frame #	EDP #	Price	EDP #	Price	EDP #	Price
M1.6 x .35	0	VE0000150	\$ 329.00			VE0000184	\$ 191.00
M2 x .4	1	VE0000151	\$ 329.00			VE0000185	\$ 191.00
M2.5 x .45	1	VE0000153	\$ 329.00			VE0000186	\$ 191.00
M3 x .5	2	VE0000152	\$ 329.00			VE0000187	\$ 191.00
M3.5 x .6	2	VE0000154	\$ 329.00	VE0000169	\$ 286.00	VE0000188	\$ 191.00
M4 x .7	2	VE0000155	\$ 329.00	VE0000170	\$ 286.00	VE0000189	\$ 191.00
M5 x .8	3	VE0000156	\$ 329.00	VE0000171	\$ 286.00	VE0000187	\$ 191.00
M6 x 1	3	VE0000157	\$ 329.00	VE0000172	\$ 286.00	VE0000191	\$ 191.00
M8 x 1.25	4	VE0000158	\$ 329.00	VE0000173	\$ 286.00	VE0000192	\$ 191.00
M10 x 1.5	4	VE0000160	\$ 329.00	VE0000174	\$ 286.00	VE0000193	\$ 191.00
M10 x 1.25	4	VE0000159	\$ 329.00	VE0000175	\$ 286.00	VE0000194	\$ 191.00
M12 x 1.75	4	VE0000161	\$ 329.00	VE0000176	\$ 286.00	VE0000195	\$ 191.00
M12 x 1.25	4	VE0000162	\$ 329.00	VE0000177	\$ 286.00	VE0000196	\$ 191.00
M14 x 2	5	VE0000163	\$ 329.00	VE0000178	\$ 286.00	VE0000197	\$ 191.00
M14 x 1.5	5	VE0000164	\$ 329.00	VE0000179	\$ 286.00	VE0000198	\$ 191.00
M16 x 2	5	VE0000165	\$ 329.00	VE0000180	\$ 286.00	VE0000199	\$ 191.00
M20 x 1.5	6	VE0000166	\$ 338.00	VE0000181	\$ 322.00	VE0000200	\$ 222.00
M22 x 1.5	6	VE0000167	\$ 338.00	VE0000182	\$ 322.00	VE0000201	\$ 222.00
M24 x 3	6	VE0000168	\$ 338.00	VE0000183	\$ 322.00	VE0000202	\$ 222.00

STC COMPARATOR

1. BASE		
	EDP #	Price
Base	VE0000250	\$ 42.00
Multiple Mounting Bar	VE0000253	\$ 43.00
Dual Frame Base Assembly	VE0000251	\$ 83.00
Aluminum Handle for Hand Held Unit	VE0000252	\$ 51.00

2.FRAMES				
EDP #	Frame #	Above	To & Include	Price
VE000287	STC-101	.111(2.82mm)	.750(19.05mm)	\$ 596.00
VE000288	STC-201	.750(19.05mm)	2.0(50.8mm)	\$ 867.00

3. DIAL INDICATOR			
EDP #		Graduations	Price
VE0000254		.0001 Inch	\$ 212.00
VE0000255		.00025 Inch	\$ 212.00
VE0000256		0.002mm Metric	\$ 212.00
Electronic Indicator		Price on application	P.O.A.

4. GAGING SEGMENTS				
		Above	To & Include	Price
		.111(2.82mm)	.750(19.05mm)	\$ 378.00
		.750(19.05mm)	2.0(50.8mm)	P.O.A.

Stop Adjusting Tool		EDP #	Price
		VE0000375	\$ 24.00



ITC COMPARATOR

1. Base & Accessories		
	EDP #	Price
Base With Adapter	VI0000250	\$ 91.00
Multiple Mounting Bar	VE0000253	\$ 43.00
Dual Frame Base Assembly	VE0000251	\$ 83.00

2. FRAMES				
EDP #	Frame #	Above	To & Include	Price
VI0000001	100	.189 (4.8mm)	2.500 (63.5mm)	\$ 743.00
VI0000002	200	2.500 (63.5mm)	5.000 (127mm)	\$ 907.00
VI0000003	300	5.000 (127.0mm)	8.000 (203.2mm)	\$1,073.00

3. DIAL INDICATOR			
		Graduations	Price
VI0000253		.0001 Inch	\$ 212.00
VI0000254		.00025 Inch	\$ 212.00
VI0000255		0 .002 mm Metric	\$ 212.00
Electronic Indicator			P.O.A.

1. Base with adapter
2. Frame- One frame for entire range #10 to 2 1/2 diameter.
3. Indicator - Analog or electronic indicators available.
4. Segments - Full profile or Cone & Vee.



4. ITC GAGING SEGMENTS

INCH				
Full Profile - Functional Pitch Diameter			Cone and Vee - Single Element Pitch Dia.	
Size	EDP #	Price	EDP #	Price
#10-24	VI0000004	\$ 401.00	VI0000037	\$ 441.00
#10-32	VI0000005	\$ 401.00	VI0000038	\$ 441.00
#12-24	VI0000006	\$ 401.00	VI0000039	\$ 441.00
#12-28	VI0000007	\$ 401.00	VI0000040	\$ 441.00
1/4-20	VI0000008	\$ 401.00	VI0000041	\$ 441.00
1/4-28	VI0000009	\$ 401.00	VI0000042	\$ 441.00
5/16-18	VI0000010	\$ 401.00	VI0000043	\$ 441.00
5/16-24	VI0000011	\$ 401.00	VI0000044	\$ 441.00
3/8-16	VI0000012	\$ 401.00	VI0000045	\$ 441.00
3/8-24	VI0000013	\$ 401.00	VI0000046	\$ 441.00
7/16-14	VI0000014	\$ 401.00	VI0000047	\$ 441.00
7/16-20	VI0000015	\$ 401.00	VI0000048	\$ 441.00
1/2-13	VI0000016	\$ 401.00	VI0000049	\$ 441.00
1/2-20	VI0000017	\$ 401.00	VI0000050	\$ 441.00
9/16-12	VI0000018	\$ 498.00	VI0000051	\$ 538.00
9/16-18	VI0000019	\$ 498.00	VI0000052	\$ 538.00
5/8-11	VI0000020	\$ 498.00	VI0000053	\$ 538.00
5/8-18	VI0000021	\$ 498.00	VI0000054	\$ 538.00
3/4-10	VI0000022	\$ 498.00	VI0000055	\$ 538.00
3/4-16	VI0000023	\$ 498.00	VI0000056	\$ 538.00
7/8-9	VI0000024	\$ 498.00	VI0000057	\$ 538.00
7/8-14	VI0000025	\$ 498.00	VI0000058	\$ 538.00
1"-8	VI0000026	\$ 498.00	VI0000059	\$ 538.00
1"-12	VI0000027	\$ 498.00	VI0000060	\$ 538.00
1"-14	VI0000028	\$ 498.00	VI0000061	\$ 538.00
1 1/8"-7	VI0000029	\$ 515.00	VI0000062	\$ 555.00
1 1/8"-12	VI0000030	\$ 515.00	VI0000063	\$ 555.00
1 1/4"-7	VI0000031	\$ 515.00	VI0000064	\$ 555.00
1 1/4"-12	VI0000032	\$ 515.00	VI0000065	\$ 555.00
1 3/8"-6	VI0000033	\$ 515.00	VI0000066	\$ 555.00
1 3/8"-12	VI0000034	\$ 515.00	VI0000067	\$ 555.00
1 1/2"-6	VI0000035	\$ 515.00	VI0000068	\$ 555.00
1 1/2"-12	VI0000036	\$ 515.00	VI0000069	\$ 555.00

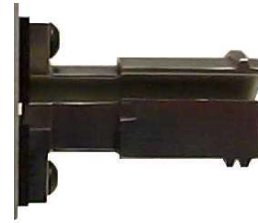

Gaging Segments
Functional Size
 (Maximum Material Condition)
 Use full profile functional gaging segments.

Gaging Segments
Pitch Diameter Size
 (Minimum Material Condition)
 Use single element gaging segments.
 Cone & Vee

METRIC				
Full Profile- Functional Pitch Diameter			Cone and Vee- Single Element Pitch Dia.	
Size	EDP #	Price	EDP #	Price
M5x.8	VI0000070	\$ 401.00	VI0000083	\$ 441.00
M6x1.0	VI0000071	\$ 401.00	VI0000084	\$ 441.00
M8x1.25	VI0000072	\$ 401.00	VI0000085	\$ 441.00
M10x1.5	VI0000073	\$ 401.00	VI0000086	\$ 441.00
M10x1.25	VI0000074	\$ 401.00	VI0000087	\$ 441.00
M12x1.75	VI0000075	\$ 401.00	VI0000088	\$ 441.00
M12x1.25	VI0000076	\$ 401.00	VI0000089	\$ 441.00
M14x2	VI0000078	\$ 498.00	VI0000091	\$ 538.00
M14x1.5	VI0000077	\$ 498.00	VI0000090	\$ 538.00
M16x2	VI0000079	\$ 498.00	VI0000092	\$ 538.00
M20x1.5	VI0000080	\$ 498.00	VI0000093	\$ 538.00
M22x1.5	VI0000081	\$ 498.00	VI0000094	\$ 538.00
M24x3	VI0000082	\$ 498.00	VI0000095	\$ 538.00

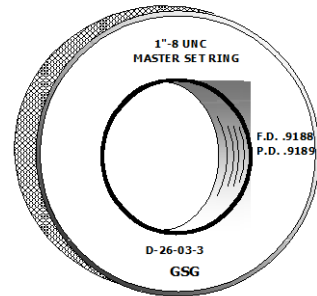
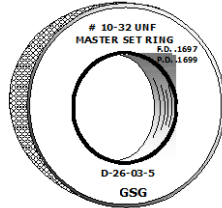

Master Setting Rings

Class "W"

INCH -Basic							
EDP #	Size	Length	Price	EDP #	Size	Length	Price
TR1000716	#10-24	3/8	\$ 426.00	TR1000732	5/8-18	9/16	\$ 494.00
TR1000717	#10-32	3/8	\$ 426.00	TR1000733	3/4-10	9/16	\$ 494.00
TR1000718	#12-24	3/8	\$ 426.00	TR1000734	3/4-16	9/16	\$ 494.00
TR1000761	#12-28	3/8	\$ 426.00	TR1000736	7/8-9	3/4	\$ 494.00
TR1000719	1/4-20	3/8	\$ 426.00	TR1000735	7/8-14	3/4	\$ 494.00
TR1000720	1/4-28	3/8	\$ 426.00	TR1000739	1"-8	3/4	\$ 494.00
TR1000721	5/16-18	3/8	\$ 426.00	TR1000737	1"-12	3/4	\$ 494.00
TR1000722	5/16-24	3/8	\$ 426.00	TR1000738	1"-14	3/4	\$ 494.00
TR1000723	3/8-16	9/16	\$ 426.00	TR1000741	1 1/8"-7	3/4	\$ 598.00
TR1000724	3/8-24	9/16	\$ 426.00	TR1000740	1 1/8"-12	3/4	\$ 598.00
TR1000725	7/16-14	9/16	\$ 426.00	TR1000743	1 1/4"-7	3/4	\$ 598.00
TR1000726	7/16-20	9/16	\$ 426.00	TR1000742	1 1/4"-12	3/4	\$ 598.00
TR1000727	1/2-13	9/16	\$ 426.00	TR1000745	1 3/8"-6	3/4	\$ 598.00
TR1000728	1/2-20	9/16	\$ 426.00	TR1000744	1 3/8"-12	3/4	\$ 598.00
TR1000729	9/16-12	9/16	\$ 494.00	TR1000747	1 1/2"-6	3/4	\$ 598.00
TR1000730	9/16-18	9/16	\$ 494.00	TR1000746	1 1/2"-12	3/4	\$ 598.00
TR1000731	5/8-11	9/16	\$ 494.00				

METRIC - Basic 6H			
EDP #	Size	Length	Price
TR1000758	M5x.8	3/8	\$426.00
TR1000759	M6x1	3/8	\$426.00
TR1000760	M8x1.25	9/16	\$426.00
TR1000749	M10x1.5	9/16	\$426.00
TR1000748	M10x1.25	9/16	\$426.00
TR1000751	M12x1.75	9/16	\$426.00
TR1000750	M12x1.25	9/16	\$426.00
TR1000753	M14x2	9/16	\$494.00
TR1000752	M14x1.5	9/16	\$494.00
TR1000754	M16x2	9/16	\$494.00
TR1000755	M20x1.5	3/4	\$494.00
TR1000756	M22x1.5	3/4	\$494.00
TR1000757	M24x3	3/4	\$494.00

ZERO SPINDLES

Zero Spindle	
Spindle #	Price
AD-012	\$ 1,102.00
AD-013	\$ 1,328.00
AD-014	\$ 1,559.00
AD-015	\$ 1,763.00



Thread Checking Attachments	
EDP #	Price
AD-1200	\$404.00
ROLL FOR ABOVE	\$191.00



Zero Spindle Accessories					
For Spindle #	Centralizing Collar		For SPINDLE	Spindle-Loks	
	Collar #	Price		Lok #	Price
AD-012	AC-257	\$ 147.00	AD-012	AD-286	\$ 104.00
AD-013	AC-157-A	\$ 160.00	AD-013	AD-386	\$ 123.00
AD-014	AC-457-A	\$ 174.00	AD-014	AD-486	\$ 137.00
AD-015	AC-657-A	\$ 206.00	AD-015	AD-586	\$ 154.00

Zero Spindle Fixture Accessories			
Fixture Bases		Indicator Mount Assemblies	
Base #	Price	Assy #	Price
AD-1032	\$352.00	AD-006	\$343.00
AD-1033	\$438.00	AD-008	\$306.00
AD-1034	\$586.00	PLEASE SPECIFY POST LENGTH	
AD-1035	\$1,027.00	WHEN ORDERING THE AD-006	

Diaphragm Push Arbors and Zero Spindle Diaphragm Push Arbor Combinations						
For Spindle #	Flange Type Push Arbors and Combos				Between Centers Push Arbors	
	Arbor #	Price	Combo #	Price	Arbor #	Price
AD-012	AD-3222	\$1,008.00	AD-2220	\$ 2,307.00	AD-3221-A	\$ 903.00
AD-012	AD-3224	\$1,016.00	AD-2240	\$ 2,316.00	AD-3223-A	\$ 911.00
AD-012	AD-3228	\$1,027.00	AD-2290	\$ 2,326.00	AD-3225-A	\$ 919.00
AD-013	AD-3233	\$1,093.00	AD-2340	\$ 2,636.00	AD-3230-A	\$ 997.00
AD-014	AD-3243	\$1,349.00	AD-2440	\$ 3,151.00	AD-3240-A	\$ 1,096.00
AD-015	AD-3253	\$1,438.00	AD-2540	\$ 3,480.00	AD-3250-A	\$ 1,177.00
AD-015	AD-3263	\$1,471.00	AD-2640	\$ 3,551.00	AD-3260-A	\$ 1,248.00



Dual-Flex Push Arbors and Zero Spindle Dual-Flex Push Arbor Combinations						
For Spindle #	Flange Type Push Arbors and Combos				Between Centers Push Arbors	
	Arbor #	Price	Combo #	Price	Arbor #	Price
AD-012	DF-200-F	\$1,398.00	DF-200-C	\$ 2,714.00	DF-200	\$ 1,170.00
AD-012	DF-300-F	\$1,406.00	DF-300-C	\$ 2,723.00	DF-300	\$ 1,177.00
AD-012	DF-400-F	\$1,418.00	DF-400-C	\$ 2,737.00	DF-400	\$ 1,187.00
AD-012	DF-500-F	\$1,422.00	DF-500-C	\$ 2,741.00	DF-500	\$ 1,196.00
AD-013	DF-600-F	\$1,508.00	DF-600-C	\$ 3,070.00	DF-600	\$ 1,242.00
AD-013	DF-700-F	\$1,516.00	DF-700-C	\$ 3,077.00	DF-700	\$ 1,248.00
AD-014	DF-800-F	\$1,850.00	DF-800-C	\$ 3,676.00	DF-800	\$ 1,400.00
AD-014	DF-900-F	\$1,854.00	DF-900-C	\$ 3,682.00	DF-900	\$ 1,409.00
AD-015	DF-1000-F	\$1,982.00	DF-1000-C	\$ 4,050.00	DF-1000	\$ 1,502.00
AD-015	DF-1100-F	\$1,988.00	DF-1100-C	\$ 4,057.00	DF-1100	\$ 1,548.00
AD-015	DF-1200-F	\$2,016.00	DF-1200-C	\$ 4,087.00	DF-1200	\$ 1,637.00

Tork-Lok Arbors and Zero Spindle Tork-Lok Arbor Combinations

Standard Arbors and Combos					Short Series Arbors and Combos				
Spindle #	Arbor #	Price	Combo #	Price	Spindle #	Arbor #	Price	Combo #	Price
AD-013	AC-2110	\$ 521.00	AC-4110	\$ 2,247.00	AD-013	AC-8100	\$ 548.00	AC-10110	\$ 2,271.00
AD-013	AC-2210	\$ 532.00	AC-4210	\$ 2,253.00	AD-013	AC-8200	\$ 559.00	AC-10210	\$ 2,282.00
AD-013	AC-2310	\$ 548.00	AC-4310	\$ 2,271.00	AD-013	AC-8300	\$ 563.00	AC-10310	\$ 2,287.00
AD-014	AC-2410	\$ 559.00	AC-4410	\$ 2,556.00	AD-014	AC-8400	\$ 563.00	AC-10410	\$ 2,562.00
AD-014	AC-2510	\$ 566.00	AC-4510	\$ 2,566.00	AD-014	AC-8500	\$ 566.00	AC-10510	\$ 2,566.00
AD-015	AC-2610	\$ 654.00	AC-4610	\$ 2,928.00	AD-015	AC-8600	\$ 647.00	AC-10610	\$ 2,920.00
AD-015	AC-2710	\$ 699.00	AC-4710	\$ 2,971.00	AD-015	AC-8700	\$ 681.00	AC-10710	\$ 2,954.00
AD-015	AC-2810	\$ 949.00	AC-4810	\$ 3,221.00	AD-015	Standard and Short Series			
AD-015	AC-2910	\$1,046.00	AC-4910	\$ 3,317.00	AD-015	Collets are Available on Request			



PLEASE CALL FACTORY TO ENSURE COLLET AND PART LENGTH MATCH

Zero Spindle 3 Jaw Chuck Combinations

EDP #	Zero Spindle	Chuck Size	Chuck Assembly #	Price
BSC-13	AD-013	4" 3-JAW	CA-13	\$2,973.00
BSC-15	AD-015	5" 3-JAW	CA-15	\$3,490.00



Zero Spindle 5C Collet Chuck Combination

EDP #	Zero Spindle	Chuck Size	Chuck Assembly #	Price
CFC-13	AD-013	5C	CFC-13	\$2,504.00
PRECISION 5C COLLETS ARE AVAILABLE ON REQUEST				



Zero Spindle 1C Collet Chuck Combination

EDP #	Zero Spindle	Chuck Size	Chuck Assembly #	Price
CFC-12	AD-012	1C	CFC-12	\$2,255.00
PRECISION 1C COLLETS ARE AVAILABLE ON REQUEST				



GSG CHAMFER GAGE - ORDERING GUIDE

PLACE GAGE ANVIL ON FLAT SURFACE & PRESS THE "ON/CLR" BUTTON

READY

- PLACE GAGE FIRMLY ON A FLAT SURFACE

SET

- PRESS "ON/CLR"

GO

- PLACE GAGE IN HOLE FEATURE
- (LARGE END SIZE DISPLAYS ON SCREEN)

INTERCHANGABLE ANVIL ENDS

THUMB RING

ANVIL ASSEMBLY

GSG CHAMFER INDICATOR

GSG LOW PROFILE STEM COLLET

US 2017/0299367 A1

CUSTOM ANGLES AVAILABLE



Click on the code to see the interactive Chamfer Gage Catalog

The GSG Digital Chamfer Gage is sold as separate components. When placing a chamfer gage order you must purchase a **GAGE BODY** (shown to the left) along with an anvil end.

Each **GAGE BODY** is programmed for the desired angle anvil(s). Once they have been programmed at our factory they are dedicated to that particular angle. After purchasing for a particular anvil angle, you can then purchase other diameter anvils but they must be the same angle that the gage was initially purchased for.

Anvils are available individually in both standard and custom sizes or they can be purchased in sets. (see page 41)

NEW ITEM

Part #	Product Description	Price
GSG150CGB	GSG Indicator Body	\$ 645.00

GSG DIGITAL CHAMFER GAGE

NEW ITEM



The all new GSG Digital Chamfer Gage can be provided with any angle and any diameter. Buy several anvils and go from one feature check to another in as little as 20 seconds with a repeatability of .0001" The most accurate and versatile chamfer gage on the market. Can be customized for virtually any hole feature.



- Hard Programmed Ratio Measuring Mode
- SPC Cables USB, MTI, RS232
- Measuring System in English or Metric
- Travel Reverse
- Auto Off
- Rotating Bezel
- T.I.R. Measuring with Low & High Storage Recall
- Powered by Batteries, AC Jack or Output Cable
- User Tolerance Settings
- Inch/Metric Display Conversion
- Large LCD Display
- Maximum Reading Hold
- Display / Freeze Reading Hold
- Extra Large Number Display

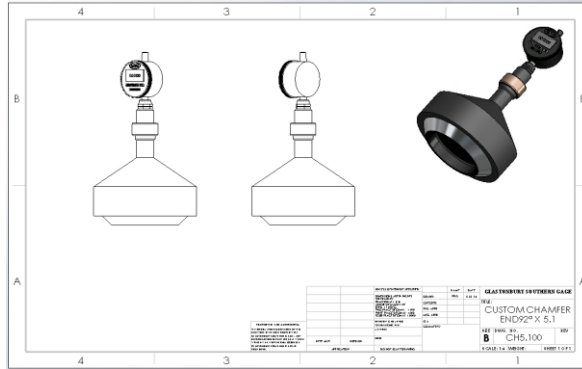

GSG CHAMFER GAGE - INDIVIDUAL ANVILS

* Must be purchased with "GAGE BODY" found on page 40.

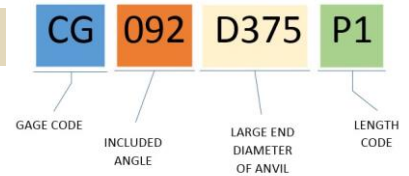

ITEM #	ANGLE (Included)	LARGE END DIAMETER	P1 LENGTH	P2 LENGTH	P3 LENGTH
CG062D0375	62° ANVIL	0.3750	\$195.00	\$310.00	\$395.00
CG062D0500	62° ANVIL	0.5000	\$260.00	\$370.00	\$440.00
CG062D0750	62° ANVIL	0.7500	\$300.00	\$390.00	\$490.00
CG092D0375	92° ANVIL	0.3750	\$205.00	\$315.00	\$405.00
CG092D0500	92° ANVIL	0.5000	\$270.00	\$380.00	\$455.00
CG092D0750	92° ANVIL	0.7500	\$310.00	\$395.00	\$595.00
CG092D1250	92° ANVIL	1.2500	\$330.00	\$430.00	\$615.00
CG092D1500	92° ANVIL	1.5000	\$350.00	\$505.00	\$635.00
CG120D0750	120° ANVIL	0.7500	\$310.00	\$395.00	\$420.00
CG120D1500	120° ANVIL	1.5000	\$345.00	\$510.00	\$540.00
CG120D2500	120° ANVIL	2.5000	\$475.00	\$575.00	\$660.00
CG120D3250	120° ANVIL	3.2500	\$565.00	\$765.00	\$795.00
CG135D0750	135° ANVIL	0.7500	\$310.00	\$410.00	\$440.00
CG135D1500	135° ANVIL	1.5000	\$355.00	\$520.00	\$590.00
CG135D2500	135° ANVIL	2.5000	\$485.00	\$606.00	\$675.00
CG135D3500	135° ANVIL	3.5000	\$595.00	\$675.00	\$815.00

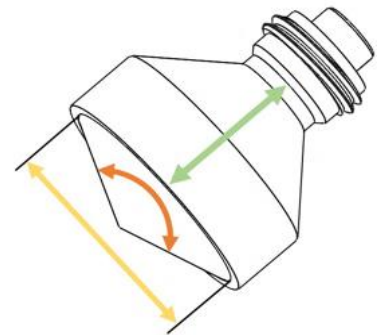

GSG CHAMFER GAGE - 3 PIECE "P1" SETS

(INCLUDES 1- GSG DIGITAL INDICATOR BODY AND ANVILS SHOWN IN THE CHART BELOW)

ITEM #	ANGLE (Included)	LENGTH	INCLUDES .375 DIA. ANVIL	INCLUDES .500 DIA. ANVIL	INCLUDES .750 DIA. ANVIL	INCLUDES 1.50 DIA. ANVIL	INCLUDES 2.50 DIA. ANVIL	PRICING
CG062P1	62° ANVIL	2.00	✓	✓	✓	X	X	\$1,250.00
CG092P1	92° ANVIL	2.00	✓	✓	✓	X	X	\$1,280.00
CG120P1	120° ANVIL	2.00	X	X	✓	✓	✓	\$1,627.00
CG135P1	135° ANVIL	2.00	X	X	✓	✓	✓	\$1,652.00

*ADDITIONAL SETS AVAILABLE ON-LINE



For the full digital catalog of GSG Chamfer Gage attachments scan this code

ABS STORAGE CASES

NEW ITEM



It is unbreakable, watertight, airtight, dustproof, chemical resistant and corrosion proof. Our cases are constructed to protect your gages and prevent damage and corrosion.

High Impact structural copolymer that makes it extremely strong and durable. Its exclusive 1/4" (6.4 mm) neoprene o-ring and ABS latches seal perfectly

We waterjet the cutouts in the foam to conform to your gage ensuring a perfect fit.

Case Prices

Part #	Product	Price
CG1050	Chamfer Gage	\$199.00
AD2100	ADM	\$230.00
GEO1120	GeoChek	\$112.00

*We can provide custom ABS cases on just about any product we manufacture Pricing is upon request for products not listed.

CHAMFER RING MASTERS

(SUPPLIED W/CERTIFICATION)

NEW ITEM

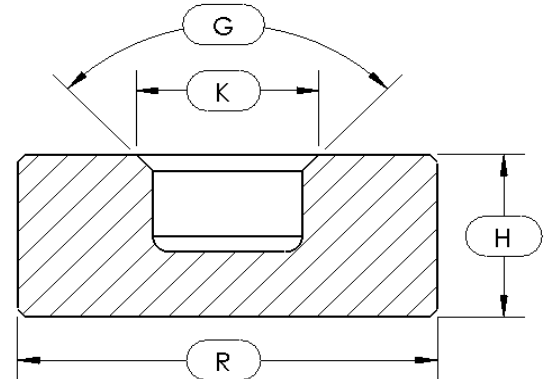
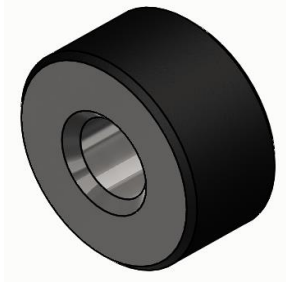

ITEM #	G	K	H	R	THRU HOLE SIZE	INCLUDES CERT.	A2 STEEL Rc58-62	CARBIDE W/STEEL JACKET
TPG90K250	90° INCLUDED	0.250	0.500	1.750	0.125	✓	\$230.00	\$285.00
TPG90K375	90° INCLUDED	0.375	0.500	1.750	0.201	✓	\$241.00	\$300.00
TPG90K500	90° INCLUDED	0.500	0.500	1.750	0.250	✓	\$253.00	\$315.00
TPG90K750	90° INCLUDED	0.750	0.750	2.000	0.500	✓	\$265.00	\$330.00
TPG90K100	90° INCLUDED	1.000	1.000	2.500	0.750	✓	\$278.00	\$346.00
TPG90K125	90° INCLUDED	1.250	1.000	2.500	1.000	✓	\$291.00	\$363.00
TPG90K150	90° INCLUDED	1.500	1.500	3.000	1.250	✓	\$305.00	\$381.00
TPG90K175	90° INCLUDED	1.750	1.500	3.500	1.500	✓	\$320.00	\$400.00
TPG90K200	90° INCLUDED	2.000	1.750	3.500	1.750	✓	\$336.00	\$420.00

FOR CUSTOM SIZES CALL FACTORY

*All Chamfer Masters come standard with flat lapped bottom

INDICATOR COLLETS



Lowest Profile Indicator Collet on the market!

Don't use up your indicator travel with a standard collet...

The GSG Indicator Collet is the lowest profile collet on the market. This allows for maximum travel to be obtained by utilizing the full throw allowed on the indicator stem.

Total stick out is .500" when mounted by the 5/8-18 thread. Available for both 3/8 (9.5mm) and 5/16" (7.9mm) indicator stems

Low Profile Collets

Part #	STEM DIAMETER	Price
CH375	3/8	\$25.00
CH312	5/16	\$25.00

NEW ITEM

For the full digital catalog of GSG Chamfer Gage attachments scan this code



MEDICAL GAGES HEXALOBES

NEW ITEM

All GSG Hexalobe Plug Gages are manufactured to ISO10664-2014 Standards
* Special sizes available upon request - Contact Factory

Steel Prices

Hexalobe	Plugs (GO or NO-GO)	Rings (GO or NO-GO)
T-06	\$ 860.00	\$ 935.00
T-07	\$ 820.00	\$ 860.00
T-08	\$ 800.00	\$ 840.00
T-09	\$ 780.00	\$ 820.00
T-10	\$ 720.00	\$ 790.00
T-15	\$ 690.00	\$ 760.00
T-20	\$ 660.00	\$ 720.00
T-25	\$ 600.00	\$ 690.00
T27	\$ 560.00	\$ 660.00
T-30	\$ 500.00	\$ 620.00
T-40	\$ 460.00	\$ 560.00
T-45	\$ 430.00	\$ 520.00
T-50	\$ 400.00	\$ 500.00
T-55	\$ 380.00	\$ 460.00
T-60	\$ 380.00	\$ 430.00
T-70	\$ 380.00	\$ 430.00
T-80	\$ 380.00	\$ 430.00
T-90	\$ 360.00	\$ 410.00
T-100	\$ 360.00	\$ 410.00

Calibrations	\$ 120.00	\$ 160.00
--------------	-----------	-----------

Carbide Prices

(Steel Jacket w/carbide insert)

Hexalobe	Plugs (GO or NO-GO)	Rings (GO or NO-GO)
T-06	\$ 995.00	\$ 1,160.00
T-07	\$ 955.00	\$ 1,090.00
T-08	\$ 935.00	\$ 1,020.00
T-09	\$ 915.00	\$ 980.00
T-10	\$ 855.00	\$ 960.00
T-15	\$ 830.00	\$ 920.00
T-20	\$ 800.00	\$ 900.00
T-25	\$ 740.00	\$ 865.00
T27	\$ 700.00	\$ 820.00
T-30	\$ 640.00	\$ 790.00
T-40	\$ 600.00	\$ 760.00
T-45	\$ 570.00	\$ 730.00
T-50	\$ 540.00	\$ 685.00
T-55	\$ 520.00	\$ 640.00
T-60	\$ 520.00	\$ 590.00
T-70	\$ 520.00	\$ 590.00
T-80	\$ 520.00	\$ 590.00
T-90	\$ 500.00	\$ 540.00
T-100	\$ 500.00	\$ 540.00

Calibrations	\$ 120.00	\$ 160.00
--------------	-----------	-----------

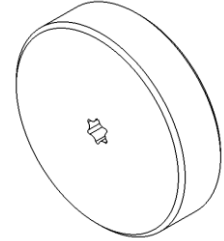
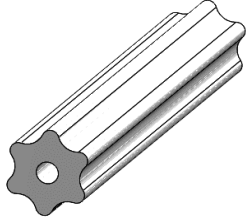

HEXALOBE DEPTH GAGES

NEW ITEM

The GSG Hexalobe Depth Gage utilizes the components of our Digital Chamfer gage. This allows for interchangeable Anvils so the user can go from one size to another in under 20 seconds. Simply purchase the main body and add Hexalobe end(s) you need.

** ALL HEXALOBE DEPTH ATTACHMENTS COME WITH (1) CERTIFIED (GO) HEXALOBE MEMBER INSTALLED.

GSG INDICATOR BODY	PRICE
GSG150CGB	\$ 645.00

(See product description on page 40)

** HEXALOBE ATTACHMENT	PRICE
T-06	\$ 1,310.00
T-07	\$ 1,270.00
T-08	\$ 1,250.00
T-09	\$ 1,230.00
T-10	\$ 1,170.00
T-15	\$ 1,140.00
T-20	\$ 1,110.00
T-25	\$ 1,050.00
T27	\$ 1,010.00
T-30	\$ 950.00
T-40	\$ 910.00
T-45	\$ 880.00
T-50	\$ 850.00
T-55	\$ 830.00
T-60	\$ 830.00
T-70	\$ 830.00
T-80	\$ 830.00
T-90	\$ 810.00
T-100	\$ 810.00



T-08 Attachment shown



HEXALOBE COLLETS

NEW ITEM



Hexalobe Handle Collets

The GSG Hexalobe Collets allow male hexalobes to be held securely in standard wire handles.

All hexalobe collets are manufactured from brass.

Fits GO or NO-GO Hexalobe Gages

Hexalobe Size	Price
T06 - T10	\$ 35.00
T15 - T25	\$ 37.00
T27 - T55	\$ 40.00
T60 - T100	\$ 45.00

Handles	Price
Single	\$ 14.00
Double Ended	\$ 16.00



Click on the code to learn more about GSG's Medical offerings

OUR PRODUCT LINES INCLUDE BUT ARE NOT LIMITED TO:

- * API Gages
- * Calibration Services
- * Chamfer Gage
- * CMM Artifacts
- * Cylindrical Plugs
- * Cylindrical Rings
- * Design & Build
- * Grinding Services
- * Hex Gages
- * Hexalobe Gages
- * ID & OD Segments
- * Luer Tapers
- * Master Setting Disc's
- * Medical Gages
- * Mic Masters
- * Oblong Gages
- * Part-Like Masters
- * Service Tooling
- * Snap Gage
- * Steel, Chrome & Carbide Pins
- * Thread Plugs
- * Thread Rings
- * Thread Work Plugs
- * Tri-Roll Comparators
- * Variable Thread Gaging Systems
- * Work Holding Fixtures
- * Zero Spindles



NEW ITEM

To see our full mechanical and digital indicator line
it us on the web at www.gsgage.com or scan this bar code

