



BIOCLIMATIC TECHNICAL CATALOG



ABOUT US

Established in the construction industry only in 2016, Haggard Construction has become a trusted name in the field of construction. Our team of experts has the knowledge, skills, and expertise to handle any project, big or small. We have completed numerous projects both domestic and international, ranging from residential homes to commercial buildings and our clients can attest to our commitment to quality and excellence.

LAMEL HAREKETİ LAMELLA MOVEMENT

Lamellerin 0° ile 90° arasında serbest dönüşü, farklı zamanlarda pergolanın maksimum hava kullanımı sağlar.

Provides maximum air using of the pergola at different times, maximum air pergola at different times provides usage.

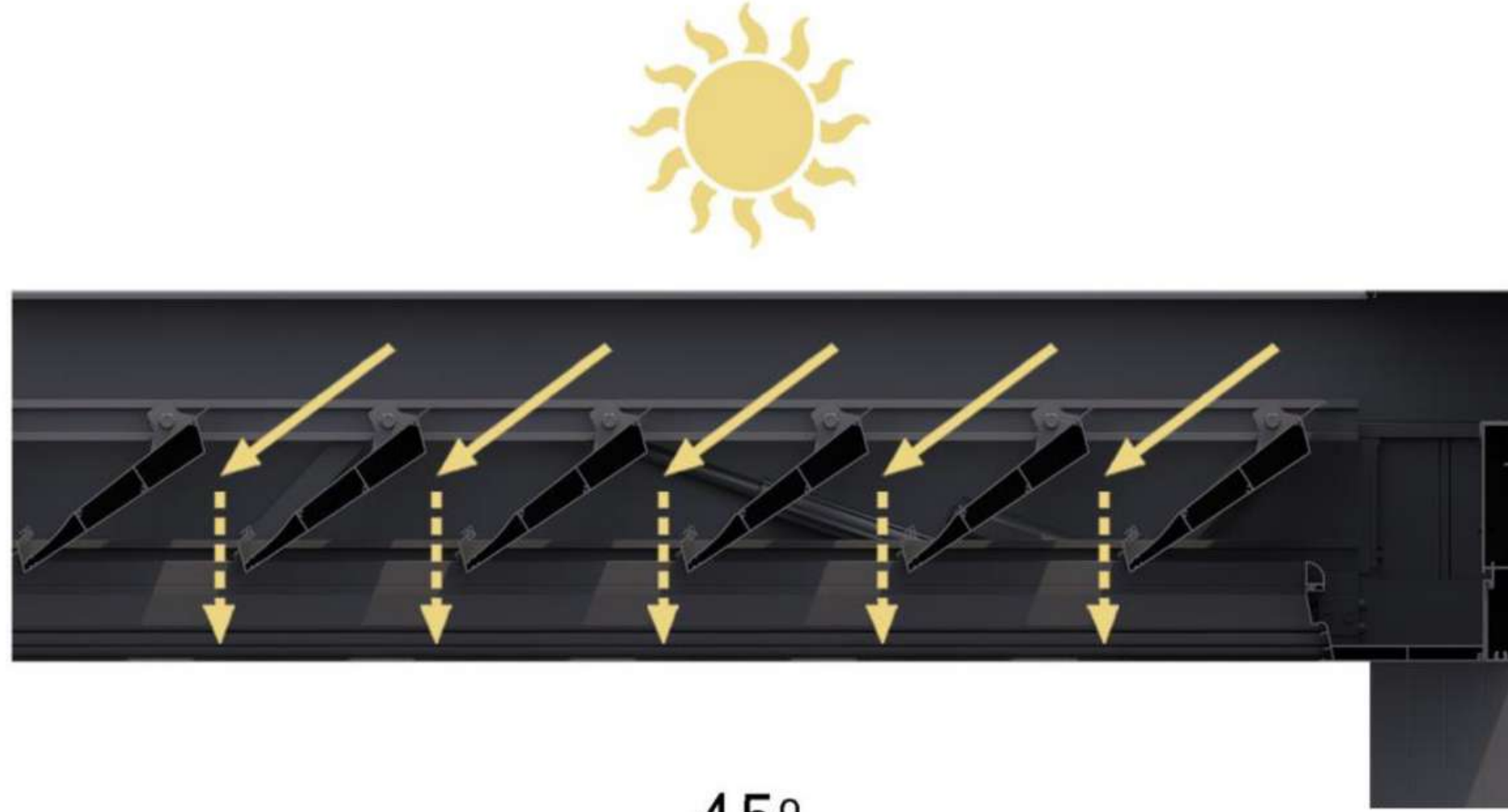

45°

Güneş ışığının girmesine izin verir, yine de aydınlatmayı kontrol eder.
Allows the sunlight to enter, still controls the lighting

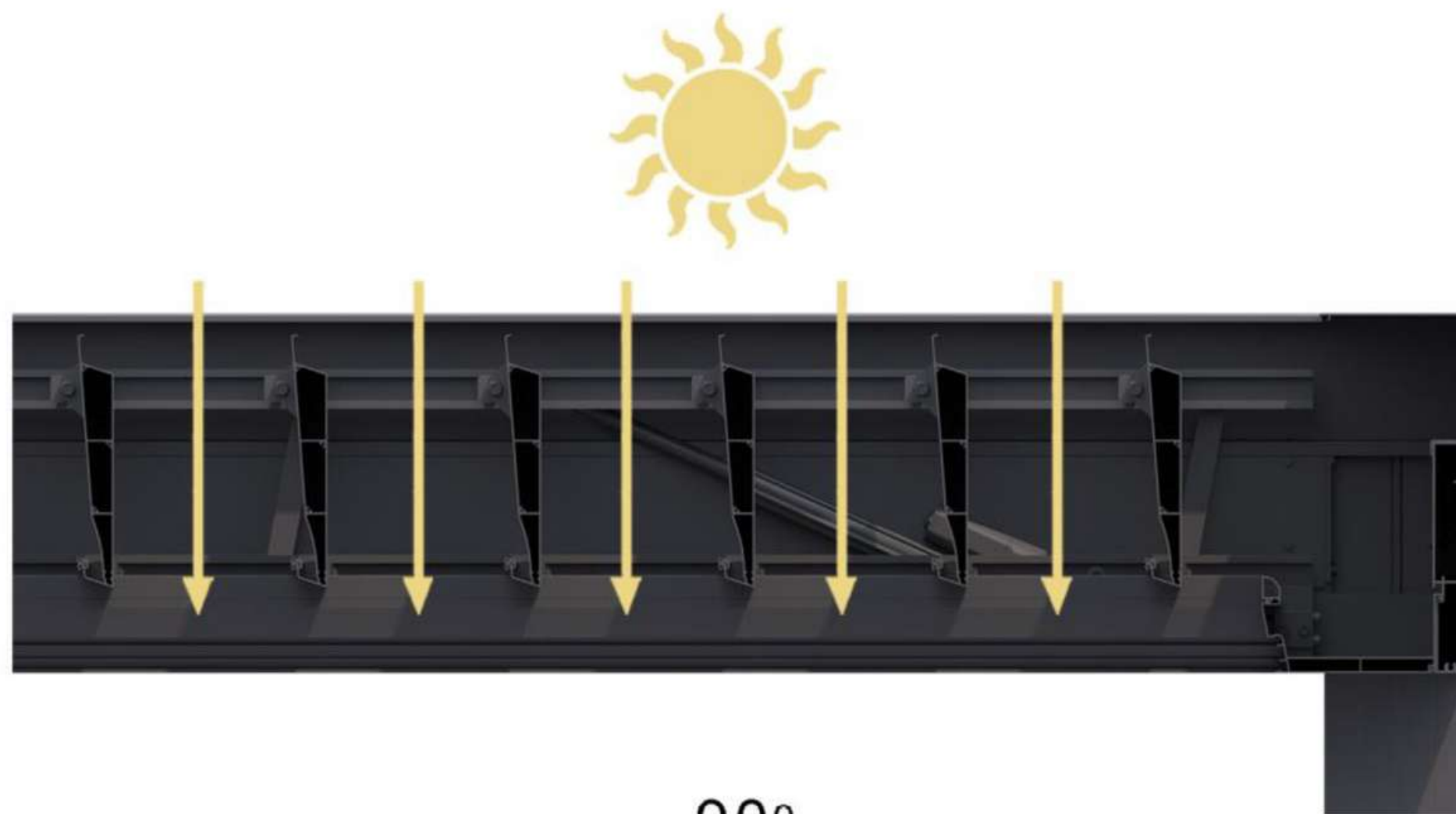

90°

Güneş ışığının tam olarak kullanılmasına izin verir.
Permits full use of the sunlight.

LAMEL HAREKETİ LAMELLA MOVEMENT

Panjurların 0° ile 90° arasında serbest dönüşü, farklı zamanlarda pergolanın maksimum hava kullanımı sağlar.

Provides maximum air using of the pergola at different times, maximum air pergola at different times provides usage.

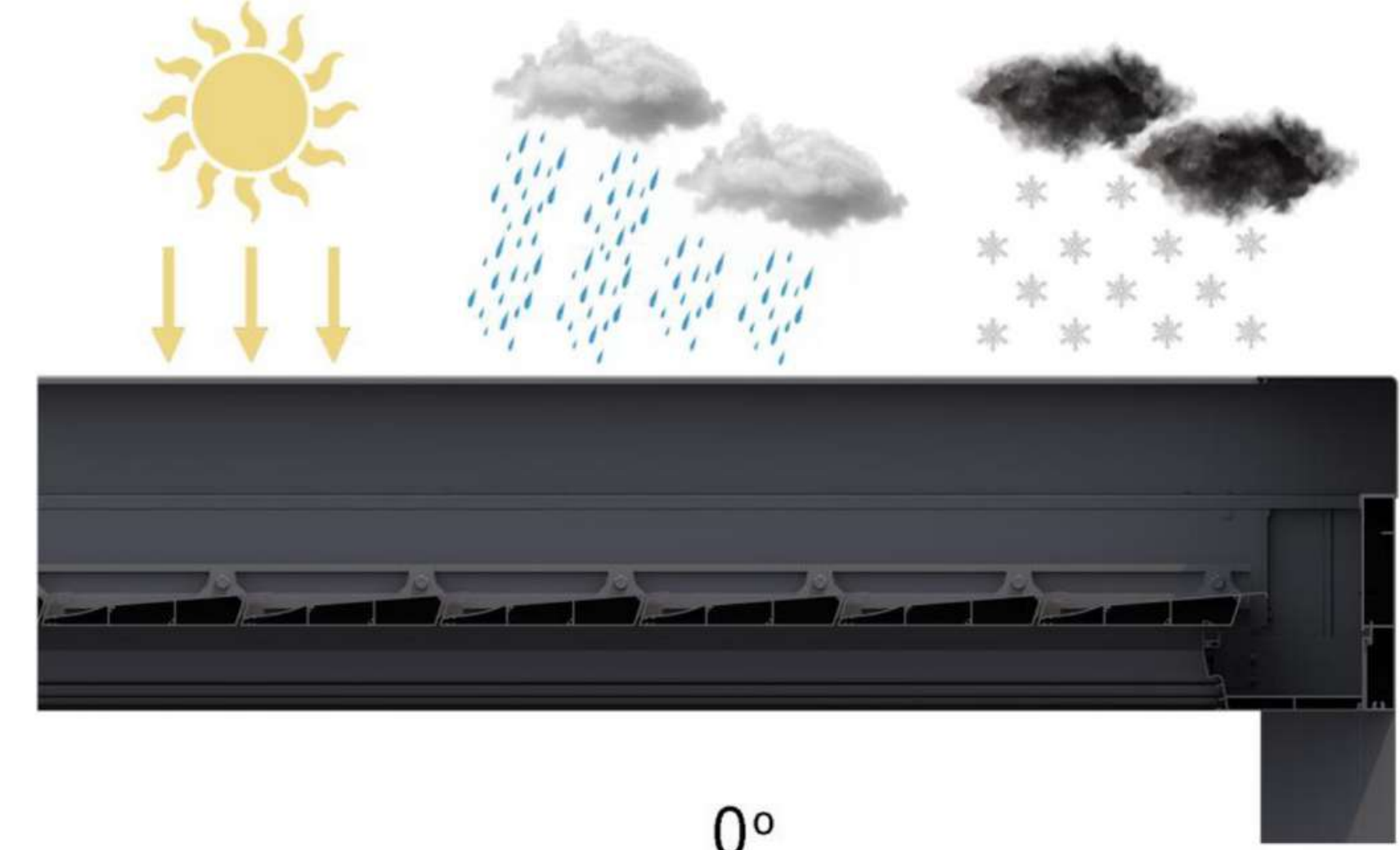

0°

Çatı kapalı kalır ve koruma sağlar her türlü hava koşulundan.
The roof remains closed, Provides protection from all weather conditions.

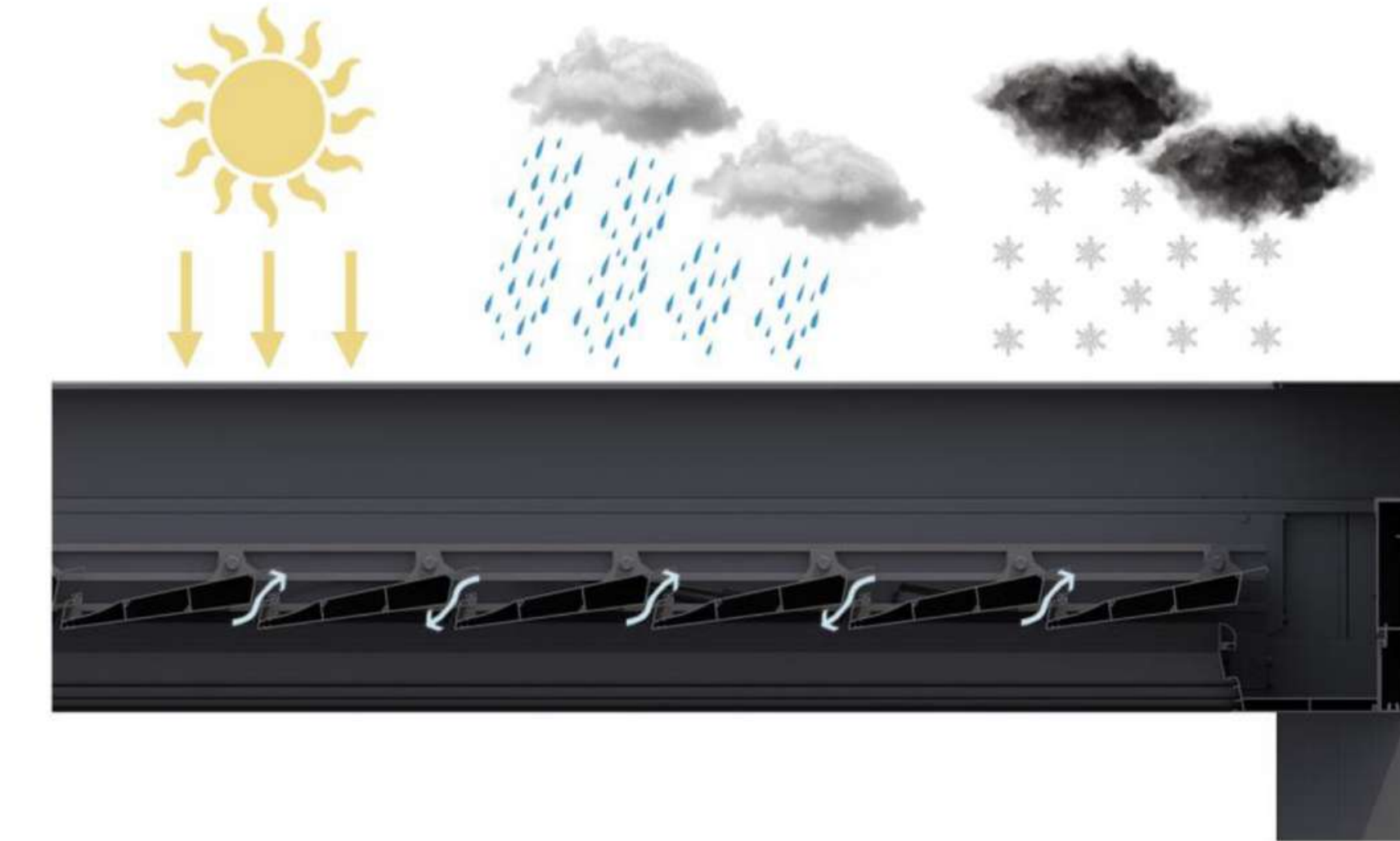

5°





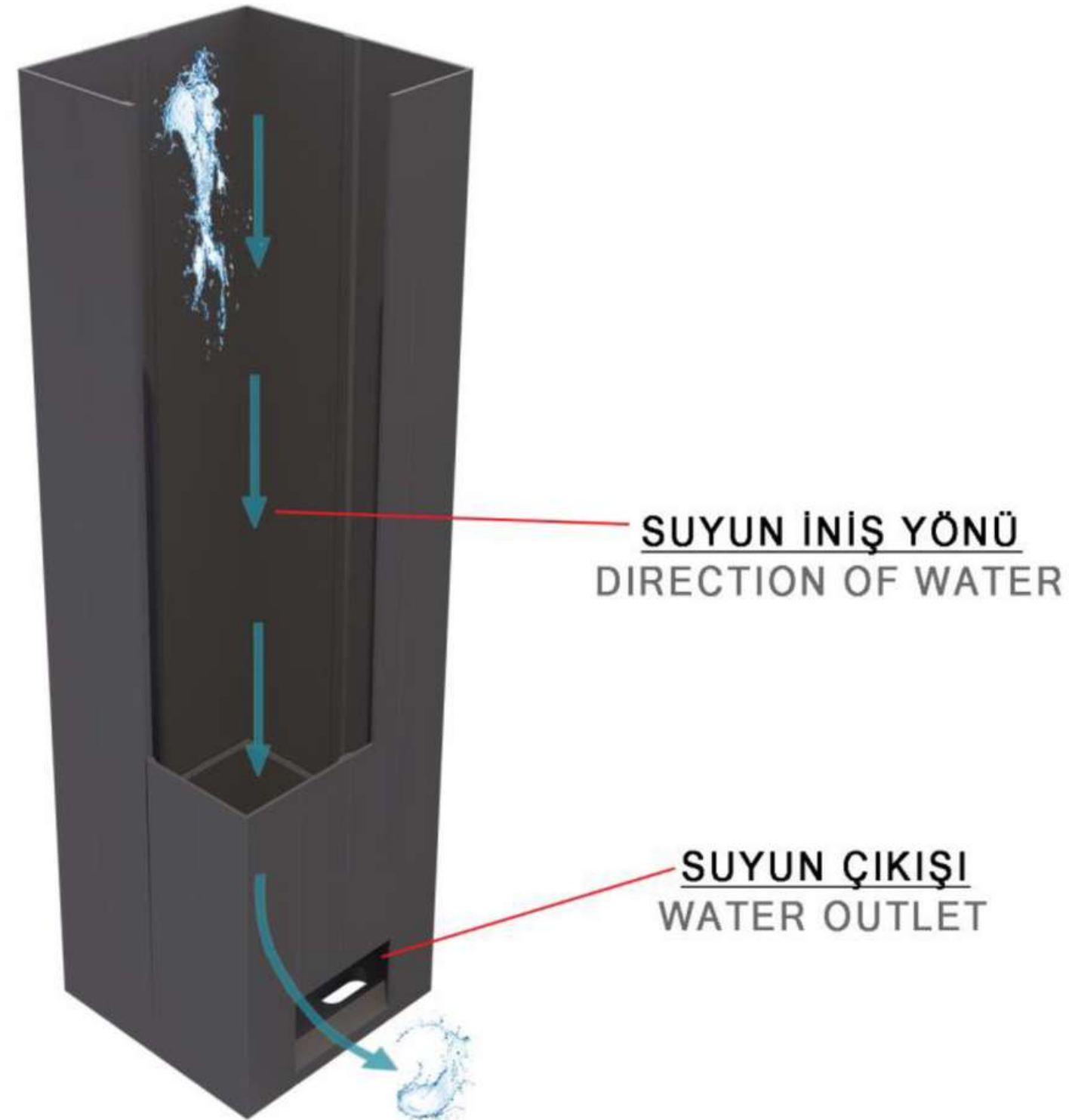
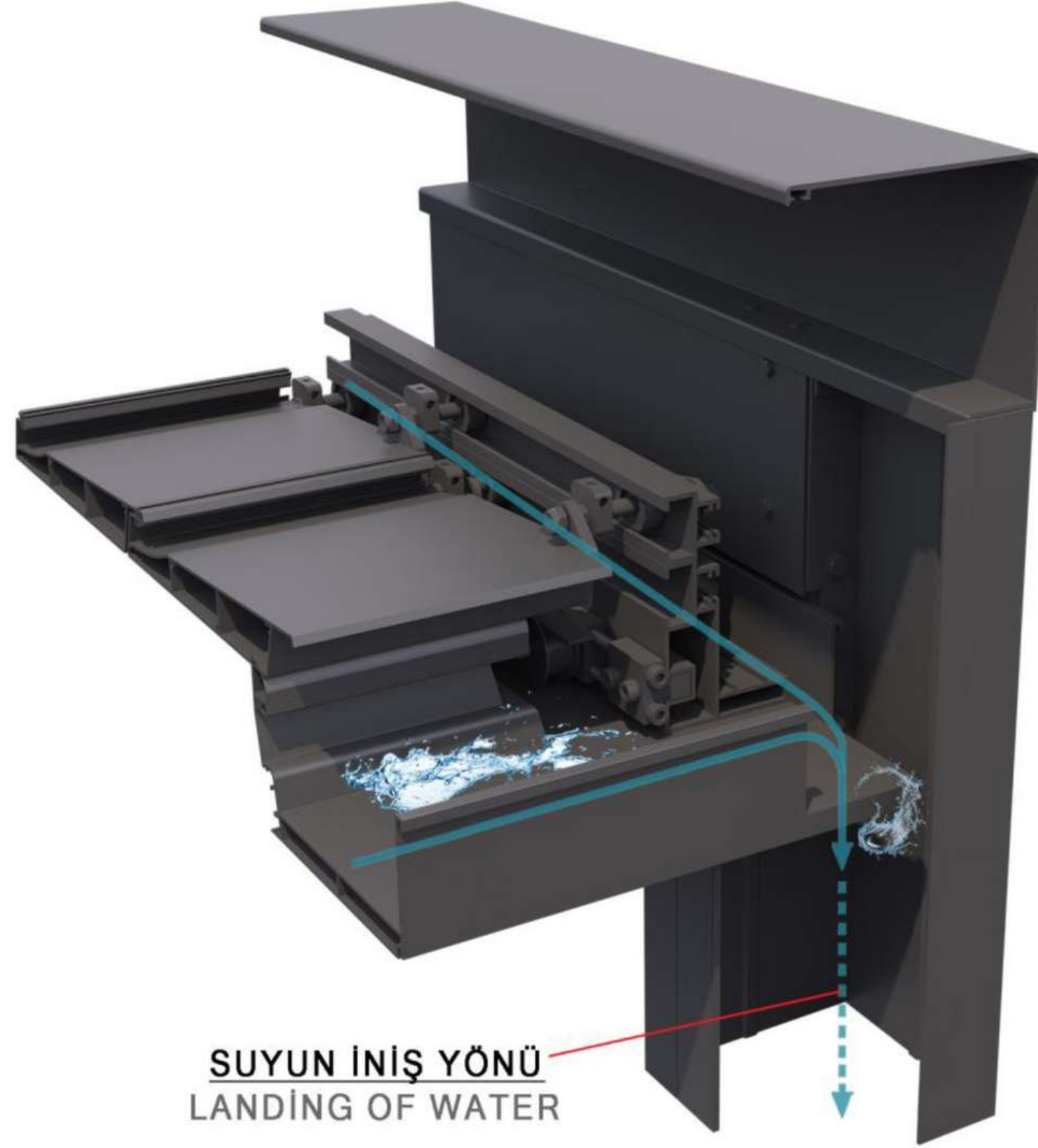

Olsa bile alanın havalandırılmasına izin verir yağmurlu veya kar yağıyor.
Provide the ventilation of the area even if it is raining or snowing.

YAĞMUR SUYU DRENAJ SİSTEMİ
RAINWATER DRAINAGE SYSTEM

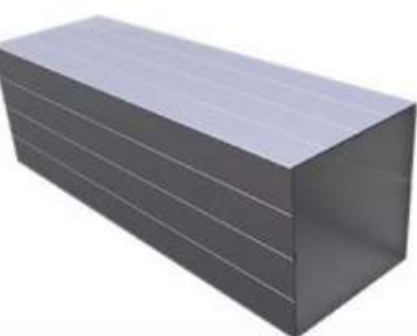
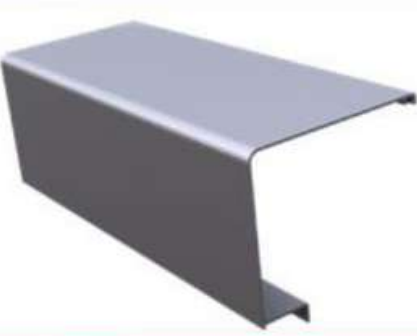

PROFİLLER
PROFILES

PROFİL TABLOSU
PROFILES CHART

PROFİL PROFILE	ÇİZİM DRAWING	AĞIRLIK WEIGHT	UZUNLUK LENGHT
2420		3,705 kg/m	7 METRE
2421		1,171 kg/m	7 METRE
2422		3,984 kg/m	7 METRE
2423		3,310 kg/m	7 METRE
2424		4,667 kg/m	7 METRE
2426		4,472 kg/m	7 METRE
2556		2,540 kg/m	7 METRE
2090		3,075 kg/m	7 METRE
2091		0,915 kg/m	7 METRE

PROFİLLER
PROFİLES

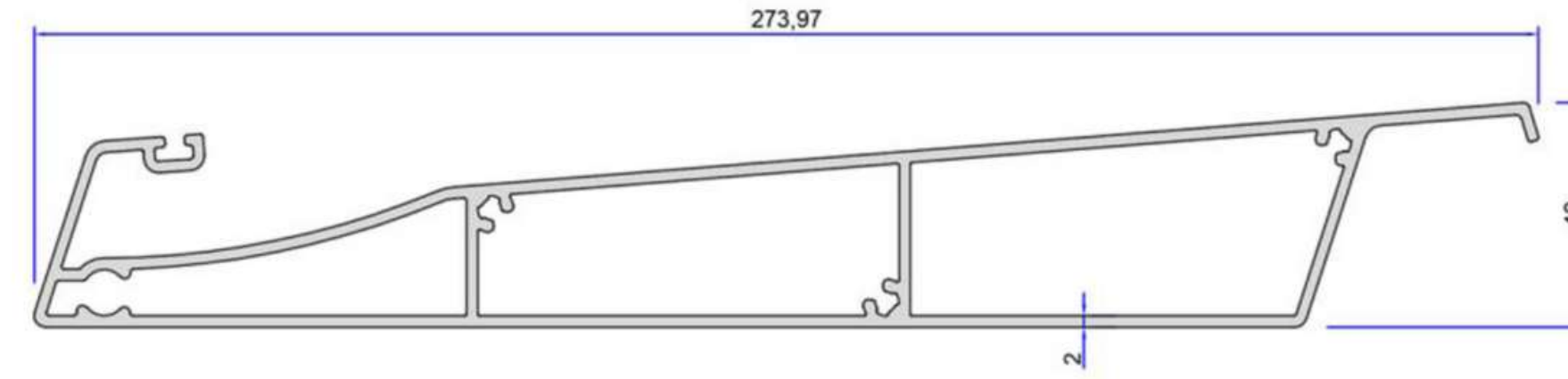

PROFİL PROFİLE	2420	İSMİ NAME	LAMEL LAMELLA	AĞIRLIK WEIGHT	3,705 kg/m	UZUNLUK LENGHT	7 METRE 7 METER
-------------------	------	--------------	------------------	-------------------	------------	-------------------	--------------------

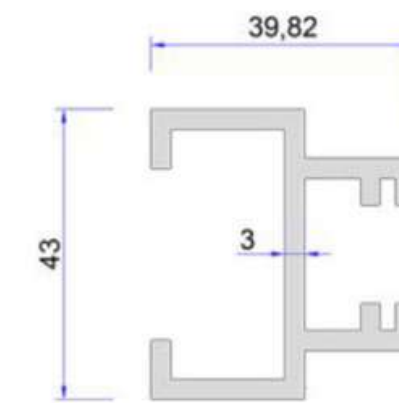
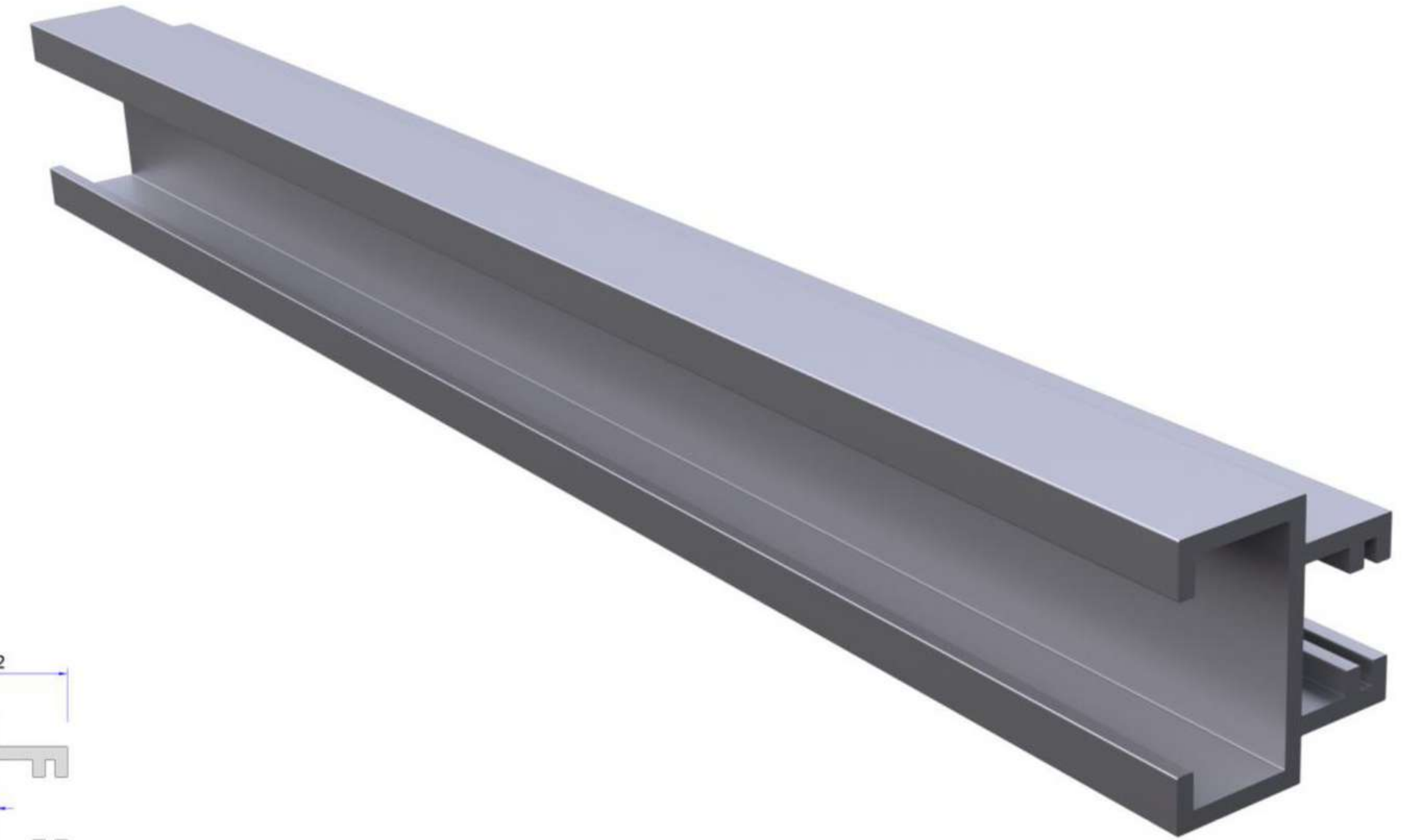

PROFİL PROFİLE	2421	İSMİ NAME	RAY ÜST EK RAY TOP ADD	AĞIRLIK WEIGHT	1,171 kg/m	UZUNLUK LENGHT	7 METRE 7 METER
-------------------	------	--------------	---------------------------	-------------------	------------	-------------------	--------------------

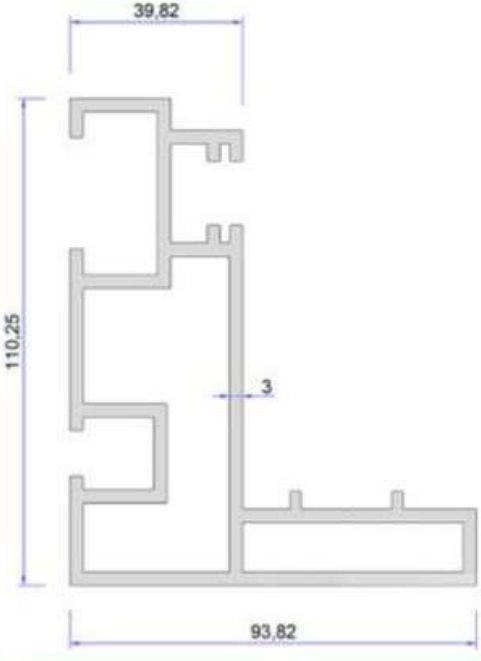
PROFİLLER
PROFİLES

PROFİL PROFİLE	2422	İSMİ NAME	RAY RAİL	AĞIRLIK WEIGHT	3,984 kg/m	UZUNLUK LENGHT	7 METRE 7 METER
-------------------	------	--------------	-------------	-------------------	------------	-------------------	--------------------

PROFİLLER
PROFİLES

PROFİL PROFİLE	2424	İSMİ NAME	40X250 OLUK DİKME 40X250 GUTTER SEWİNG	AĞIRLIK WEIGHT	4,667 kg/m	UZUNLUK LENGHT	7 METRE 7 METER
-------------------	------	--------------	---	-------------------	------------	-------------------	--------------------

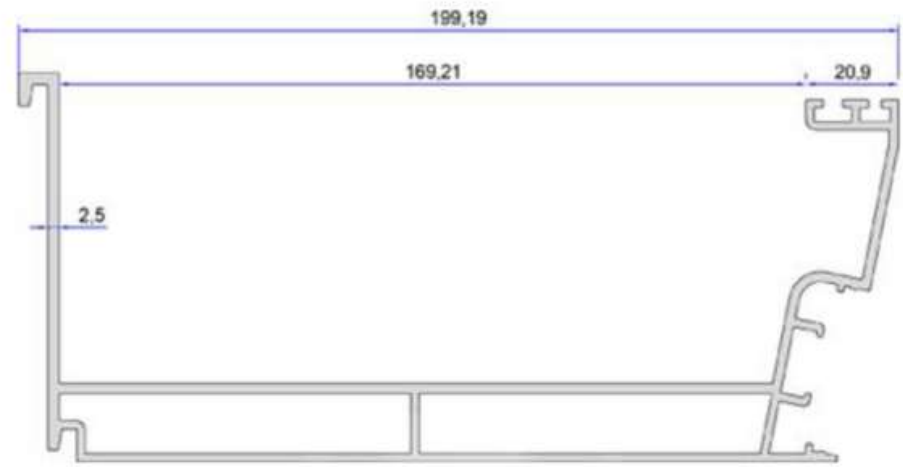
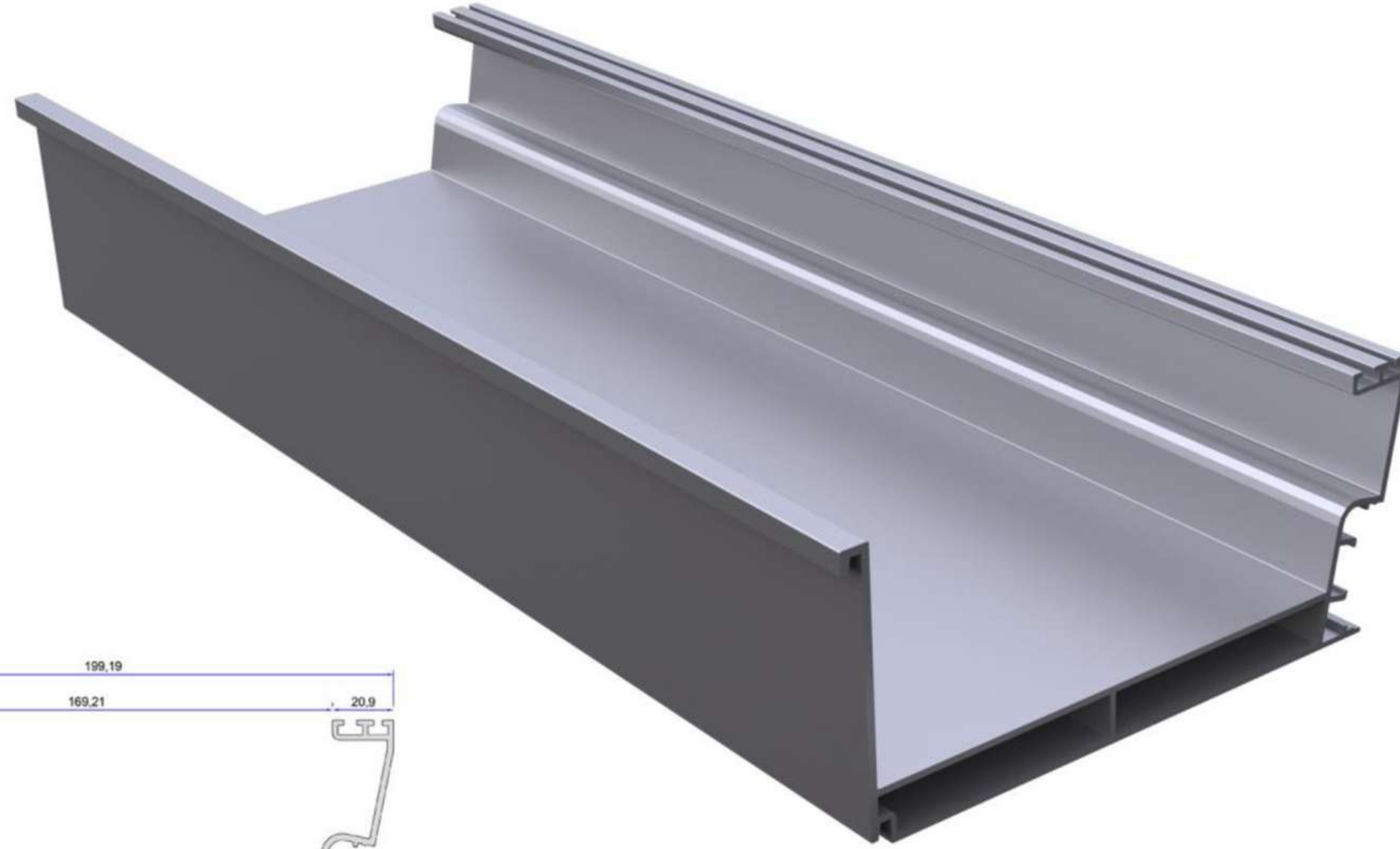

PROFİL PROFİLE	2423	İSMİ NAME	80X200 OLUK 80X200 GUTTER	AĞIRLIK WEIGHT	3,310 kg/m	UZUNLUK LENGHT	7 METRE 7 METER
-------------------	------	--------------	------------------------------	-------------------	------------	-------------------	--------------------

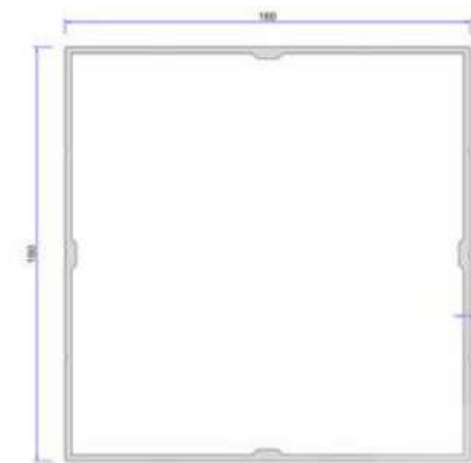
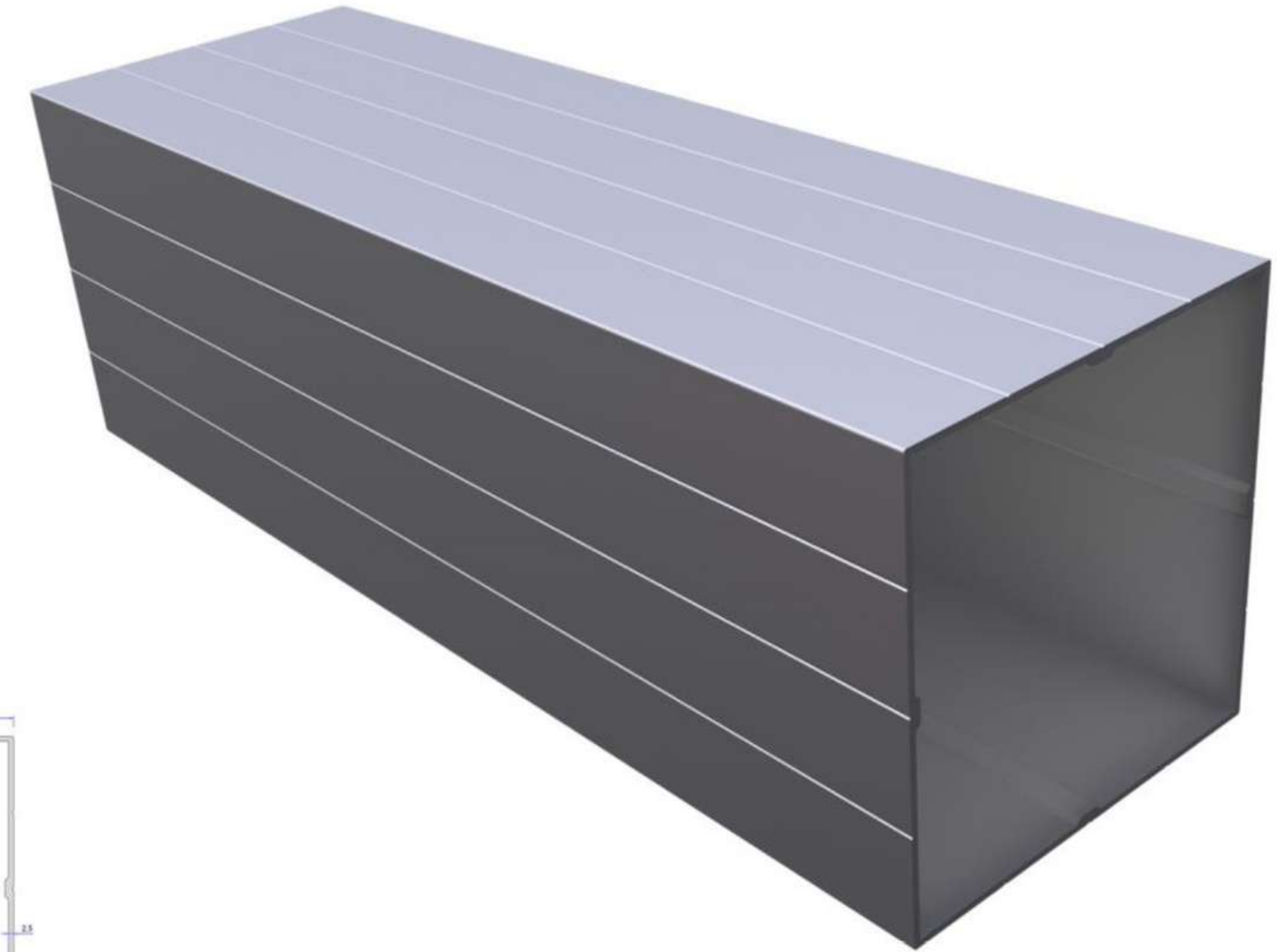

PROFİL PROFİLE	2426	İSMİ NAME	160X160 DİKME 160X160 SEWİNG	AĞIRLIK WEIGHT	4,472 kg/m	UZUNLUK LENGHT	7 METRE 7 METER
-------------------	------	--------------	---------------------------------	-------------------	------------	-------------------	--------------------

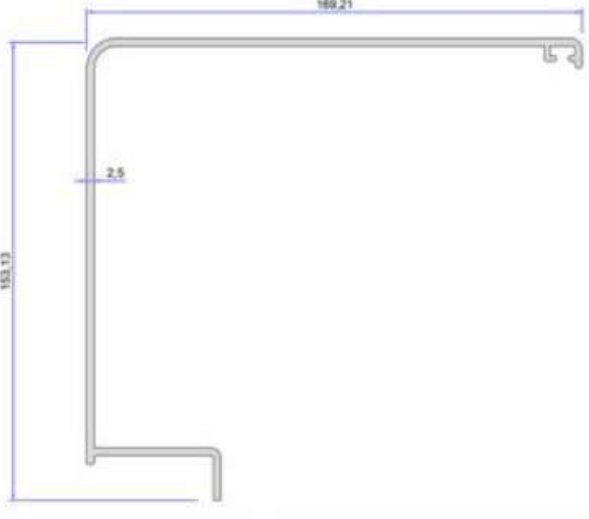
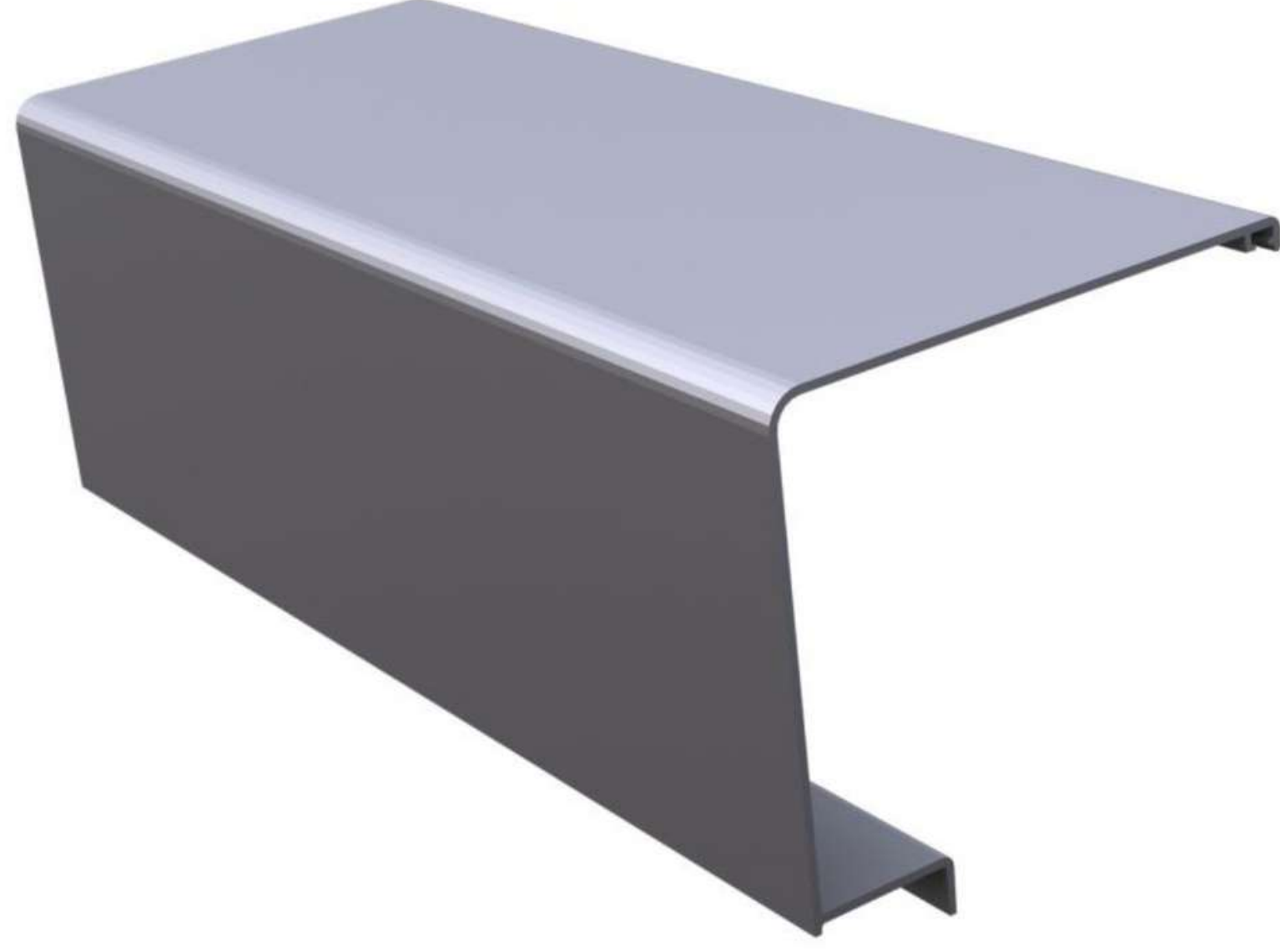
PROFİLLER
PROFİLES

PROFİL PROFİLE	2556	İSMİ NAME	LİNEER MOTOR KAPATMA PROFİLİ LINEAR MOTOR SHUTDOWN PROFILE	AĞIRLIK WEIGHT	2,540 kg/m	UZUNLUK LENGHT	7 METRE 7 METER
-------------------	------	--------------	---	-------------------	------------	-------------------	--------------------

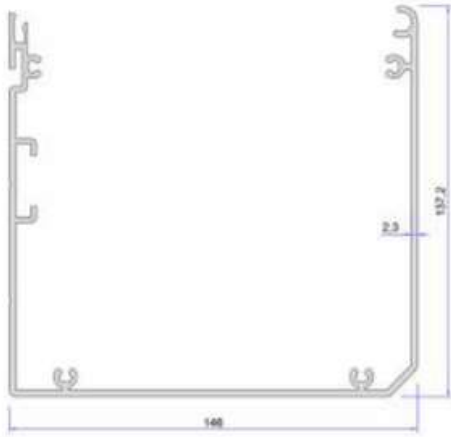
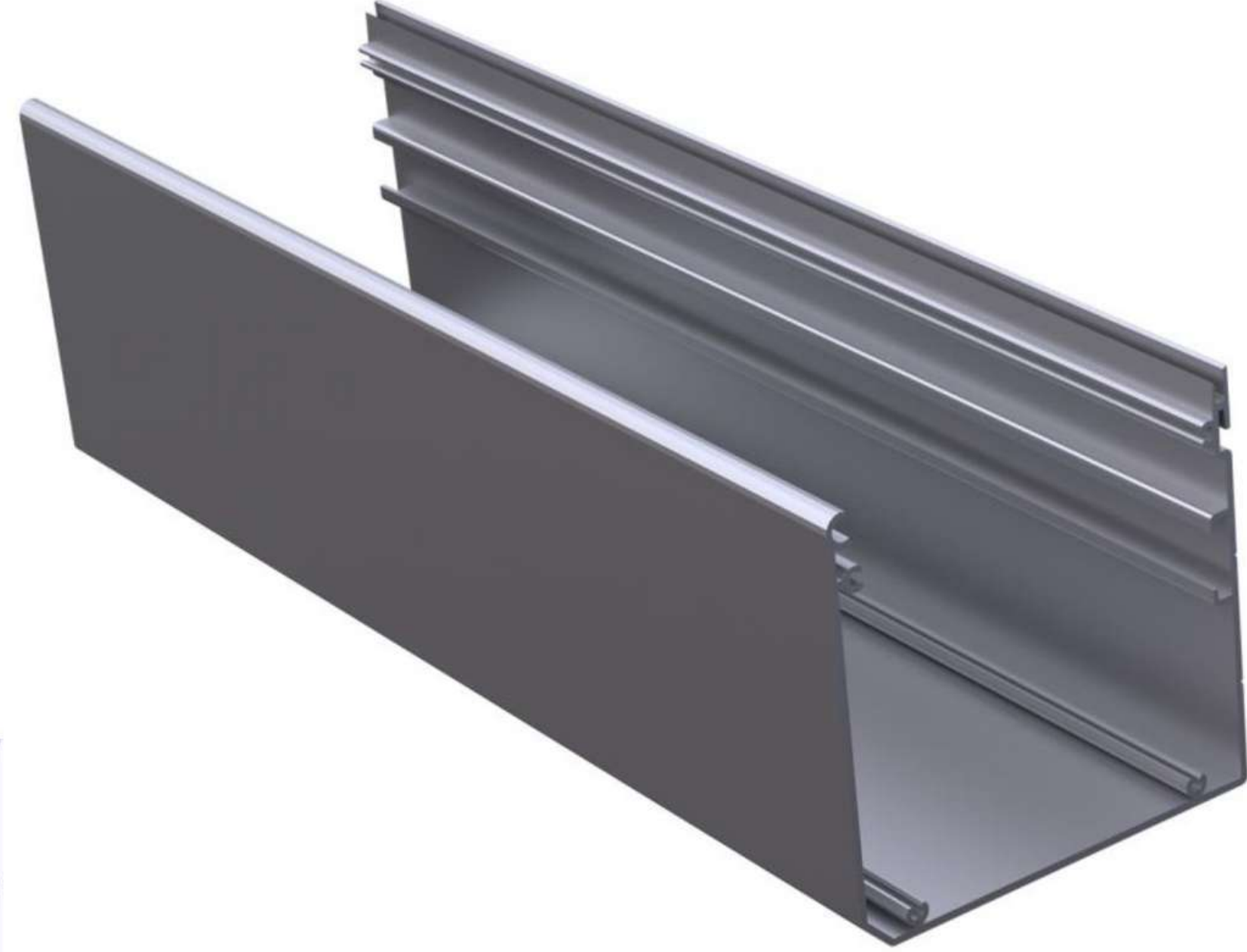

PROFİL PROFİLE	2090	İSMİ NAME	MOTOR KUTUSU ENGINE BOX	AĞIRLIK WEIGHT	3,075 kg/m	UZUNLUK LENGHT	7 METRE 7 METER
-------------------	------	--------------	----------------------------	-------------------	------------	-------------------	--------------------

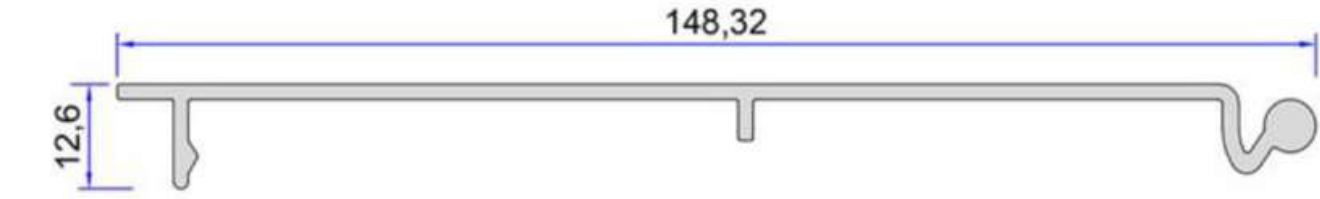
PROFİLLER
PROFİLES

PROFİL PROFİLE	2091	İSMİ NAME	MOTOR KUTUSU KAPAĞI ENGINE BOX COVER	AĞIRLIK WEIGHT	0.915 kg/m	UZUNLUK LENGHT	7 METRE 7 METER
-------------------	------	--------------	---	-------------------	------------	-------------------	--------------------



www.haggardconstruction.co.uk
293 Northfield Avenue, Ealing, London,
W5 4XB, United Kingdom
+44 7789 994837