



ROLLING ROOF TECHNICAL CATALOG



ABOUT US

Established in the construction industry only in 2016, Haggard Construction has become a trusted name in the field of construction. Our team of experts has the knowledge, skills, and expertise to handle any project, big or small. We have completed numerous projects both domestic and international, ranging from residential homes to commercial buildings and our clients can attest to our commitment to quality and excellence.

ROLLING ROOF ALÜMİNYUMUN PROFİLLERİ

ROLLING ROOF SYSTEM PROFILES

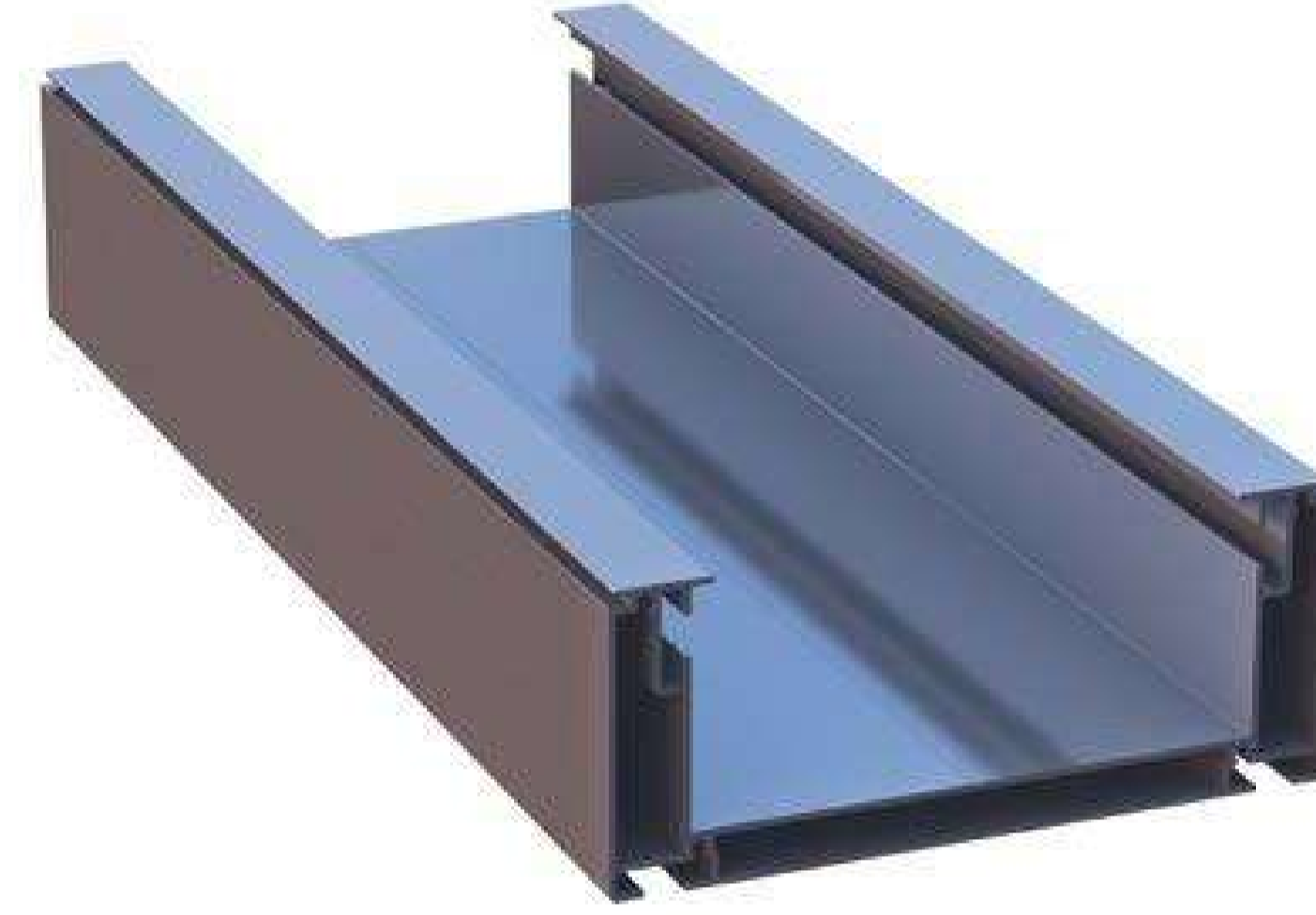
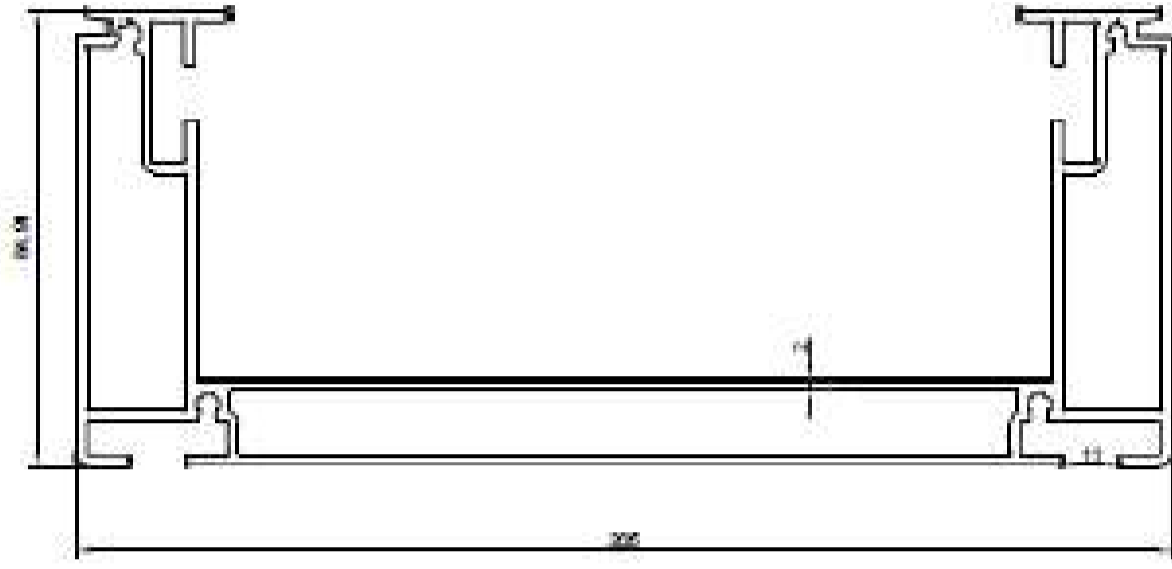

Oluk Profili
Gutter Profile
Profile Nr : 2337
Weight kg/m: 4,560
Size : 205x85x2 mm

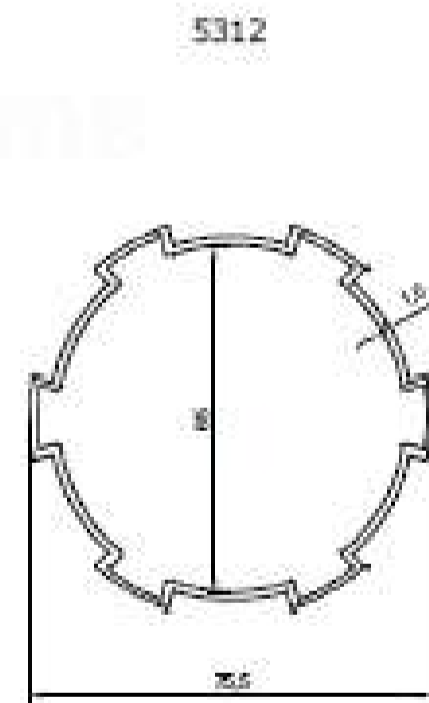
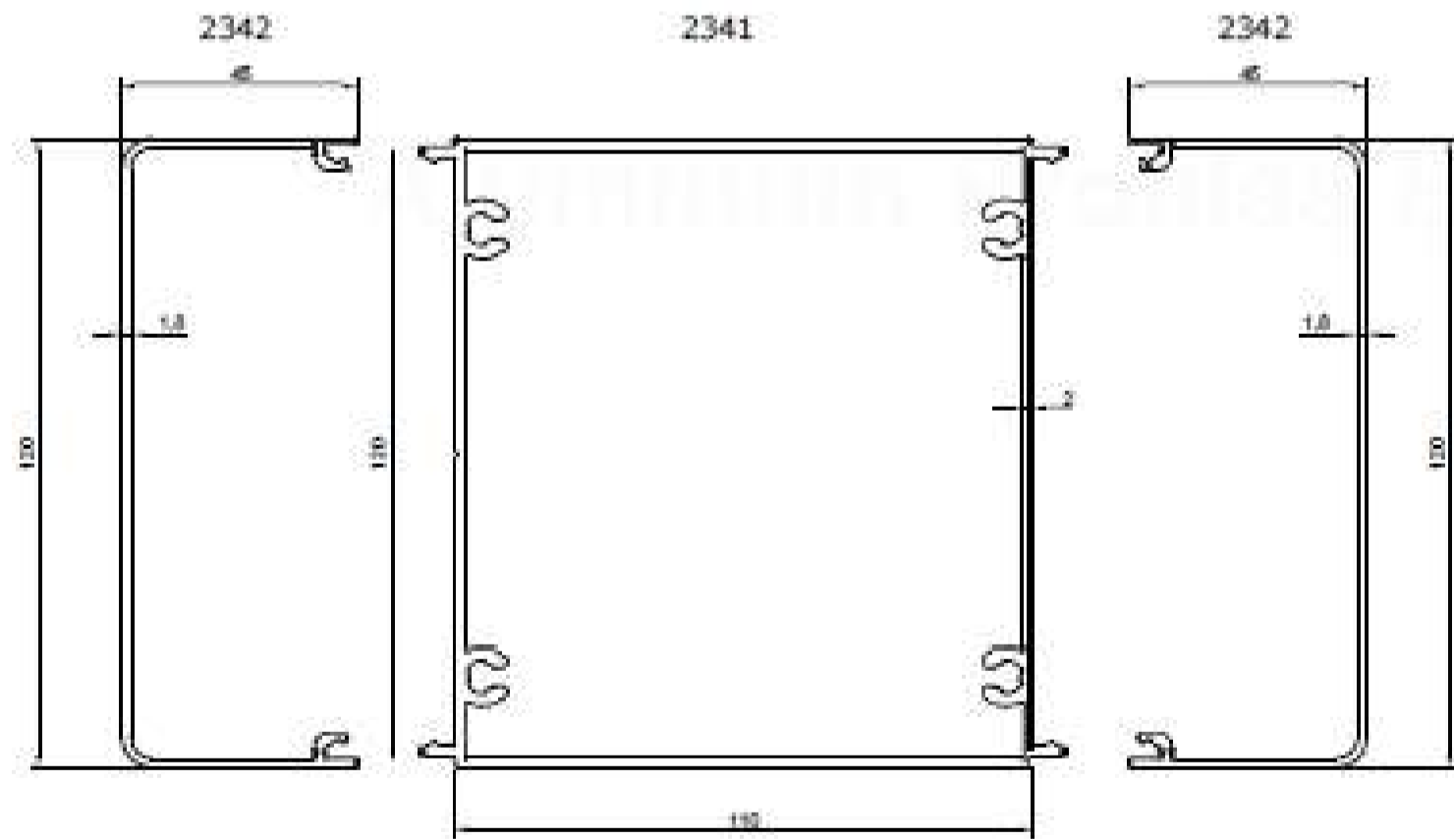
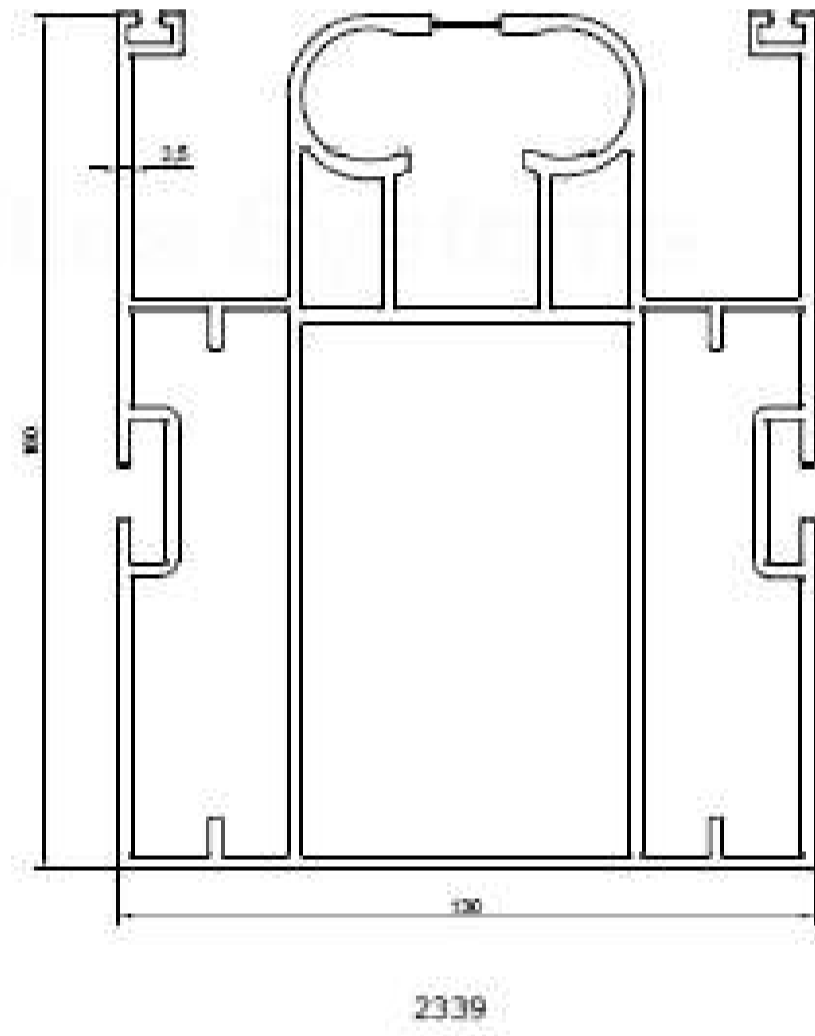

Oluk Ön/Arka Kapama Profili
Gutter Front / Rear Closure Profile
Profile Nr : 2338
Weight kg/m: 1,730
Size : 29x165x1,6 mm

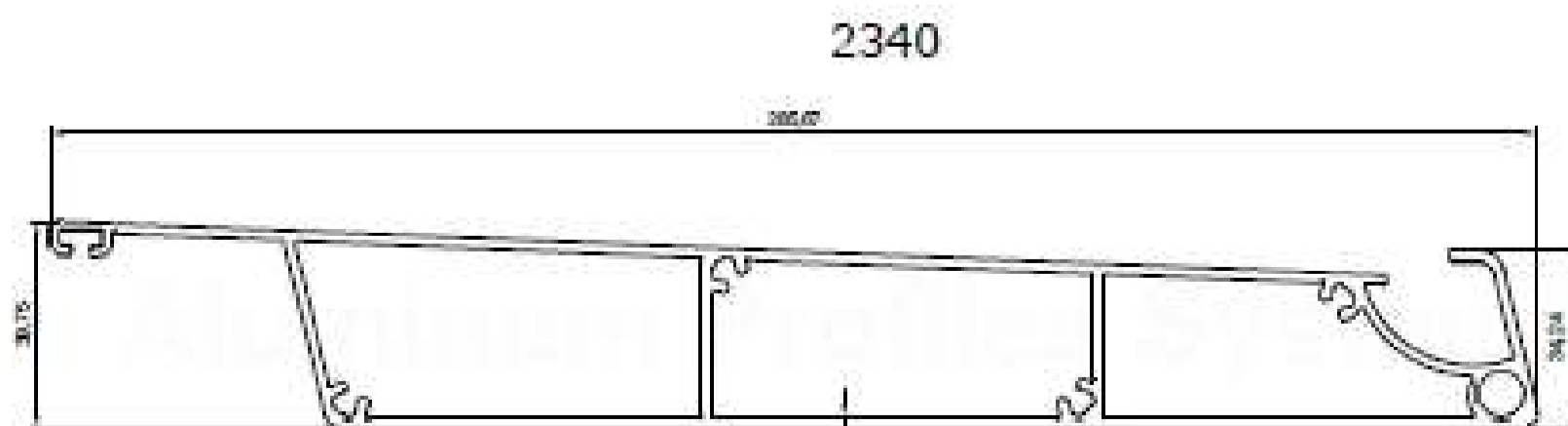



Ray Profili
Rail Profile
Profile Nr : 2339
Weight kg/m: 7,827
Size : 130x160x2,5 mm



Dikme Profili
Sewing Profile
Profile Nr : 2341
Weight kg/m: 3,028
Size : 110x120x2 mm



Dikme Kapak Profili
Sewing Cover Profile
Profile Nr : 2342
Weight kg/m: 1,055
Size : 45x120x1,8 mm



Lamel Profili
Lamella Profiles
Profile Nr : 2340
Weight kg/m: 3,906
Size : 40x286x2 mm



Motor Borusu
Motor Pipe
Profile Nr : 5312
Weight kg/m: 1,100
Size : Ø 75,5x1,5 mm

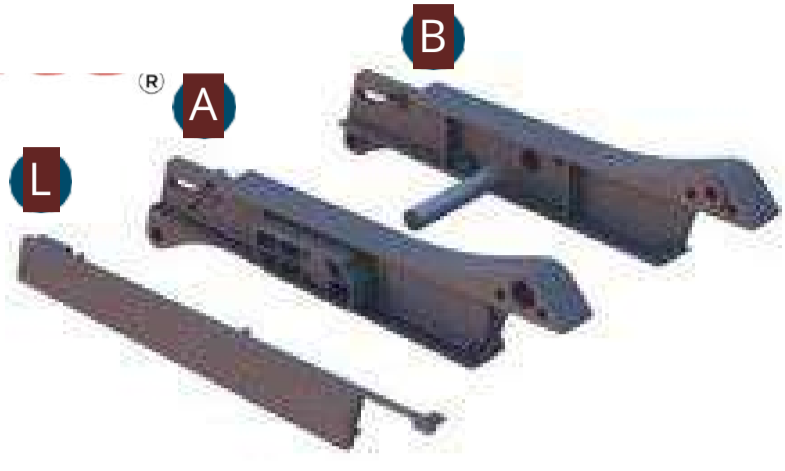

Lamel Sol Kapak Plastiği
Lamel Left Cover Plastic
Product Code: Roll-02

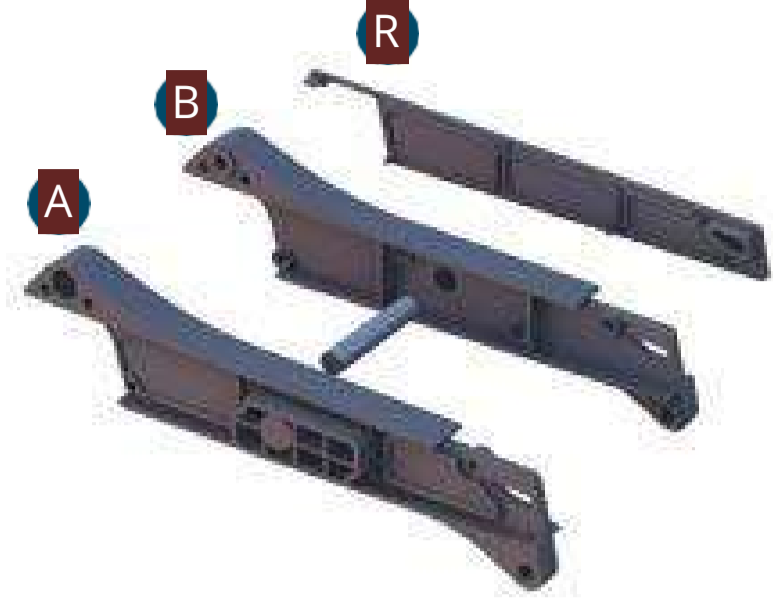

Lamel Sağ Kapak Plastiği
Lamel Right Cover Plastic
Product Code: Roll-03

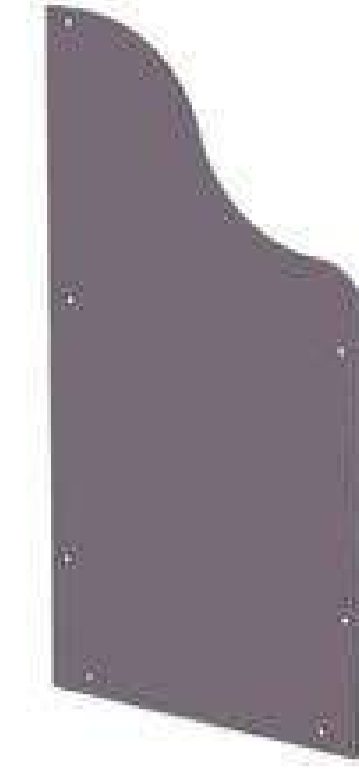

Oluk Sağ/Sol Kapak Aparatı
Gutter Right/Left Cover Plate
Product Code: Roll-11



Arka Lamel Sabitleme (Orta)
Rear Lamel Fixing (Middle)
Product Code: Roll-04



Arka Lamel Sabitleme (Kenar)
Rear Lamel Fixing (Side)
Product Code: Roll-05

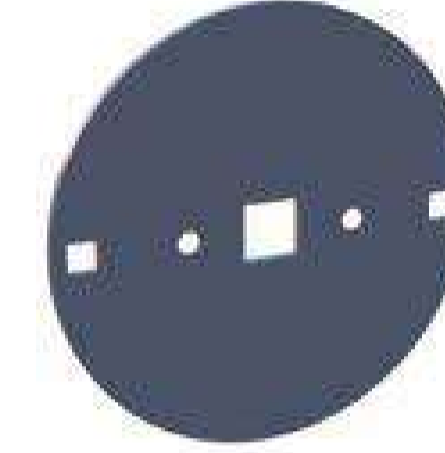

Motor Sabitleme Aparatı
Motor Fixing Apparatus
Product Code: Roll-12



Somfy Motor Switch Bileziği
Somfy Motor Switch Bracelet
Product Code: Roll-13



Ön Mafsalı Sağ/Sol
Front Lamella Joint Right / Left
Product Code: Roll-06



Orta Mafsalı Sağ/Sol
Middle Lamella Joint Right / Left
Product Code: Roll-07



Arka Mafsalı Sağ/Sol
Rear Lamella Joint Right / Left
Product Code: Roll-08

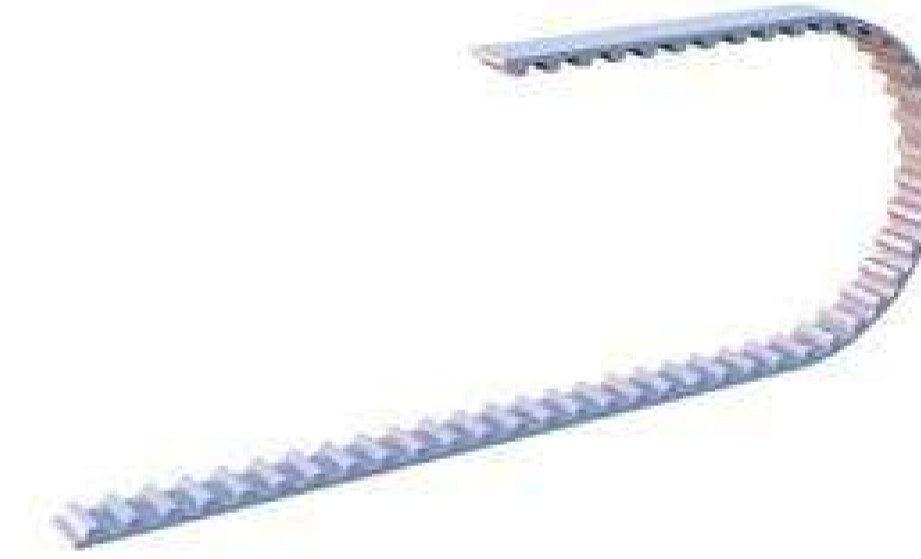

T10/16 Triger Kayış
T10/16 Timing Belt
Product Code: Roll-14



Epdm Panel Contası
Epdm Panel Gasket
Product Code: Roll-15



Küçük Teker
Small Wheel
Product Code: Roll-09



Orta Ray Teker Mafsalı
Middle Rail Wheel Joint
Product Code: Roll-10



Epdm Ray Contası
Epdm Rail Gasket
Product Code: Roll-16



4,2x19 Top Baş Vida
4,2x19 Ball Head Screw
Product Code: Roll-17

Oluk yan kapak bağlantı vidası
Gutter side cover connection bolt



4,8x22 Havşa Baş Vida
4,8x22 Countersunk Head Screw
Product Code: Roll-18

Lamel plastik bağlantı vidası
Cover plate and plastic connection screw

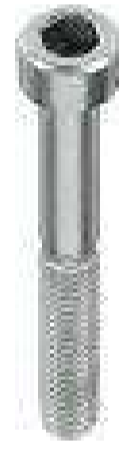

M8x40 İbus Vida
M8x40 inbus screw
Product Code: Roll-19

Lamel üst plastik birleştirme vidası
Screw connecting the plastic on the cover plate

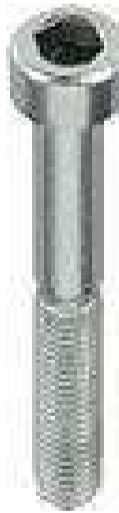

M8x65 İbus Vida
M8x65 inbus screw
Product Code: Roll-20

Lamel ile tekeri birleştirme vidası
Screw connecting plate and wheel



M8 Fiber Somun
M8 Fiber Nut
Product Code: Roll-21

Sadece roll-19 - roll-20 numarada kullanılıyor.
It is used only in roll-19 - roll-20 numbers.

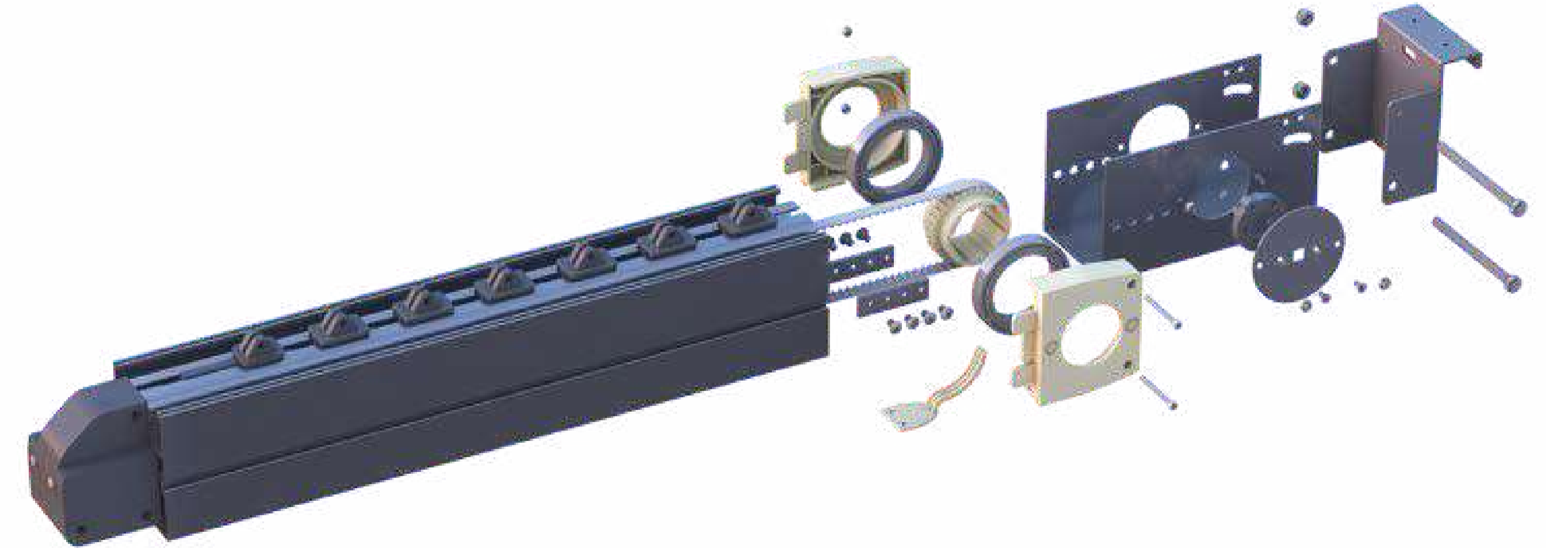
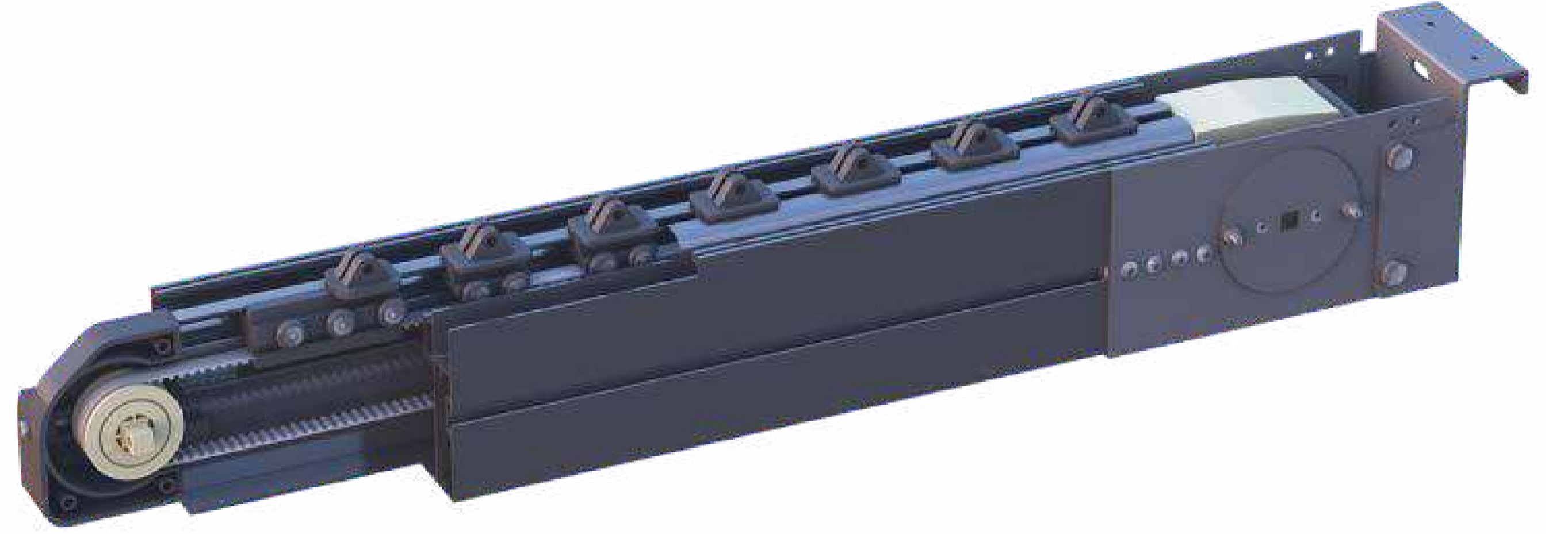

LAMEL MONTAJ ŞEMASI / LAMELLA ASSEMBLY DIAGRAM



OLUK MONTAJ ŞEMASI / GUTTER INSTALLATION SCHEME

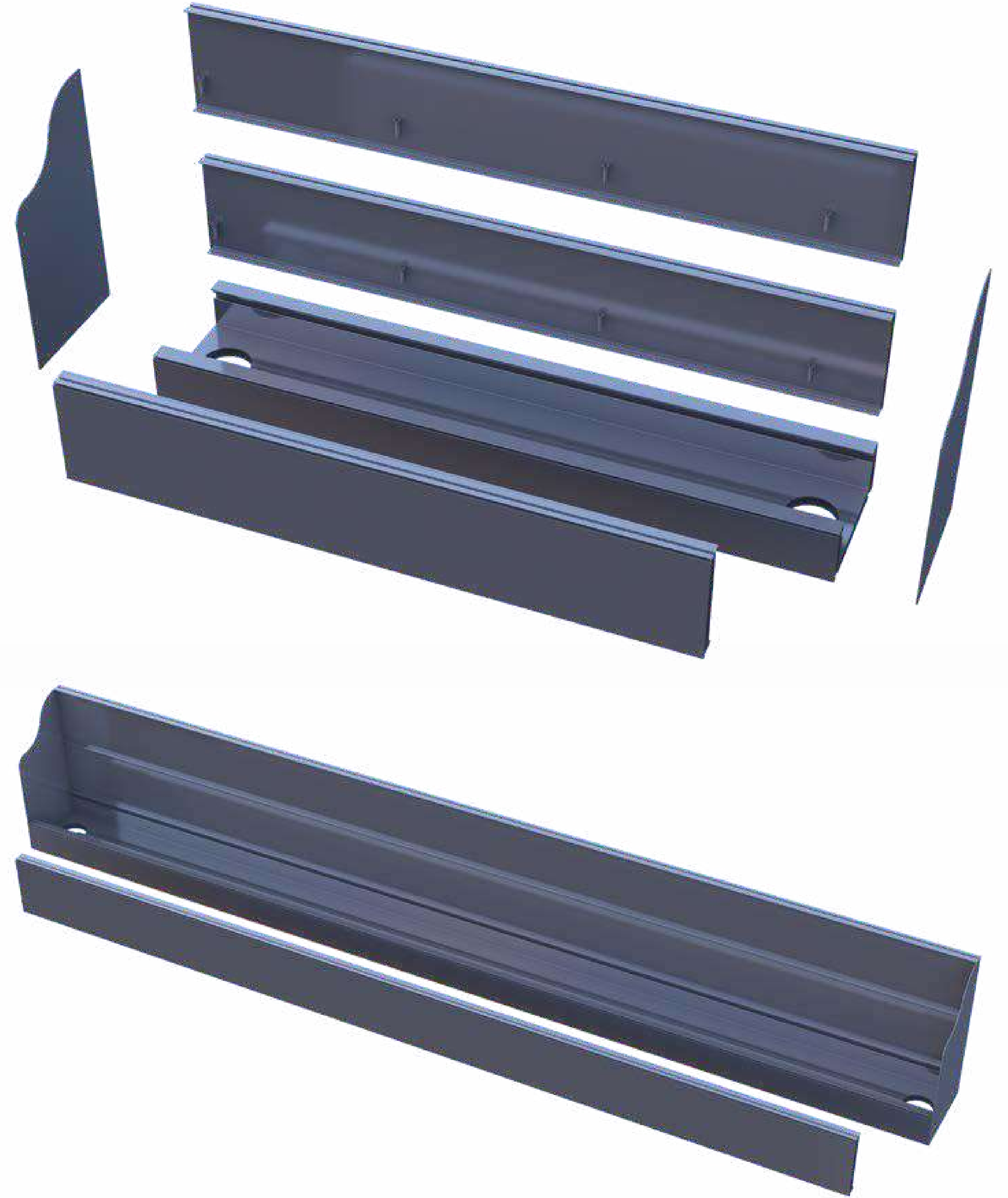

OLUK MONTAJ ŞEMASI / GUTTER INSTALLATION SCHEME

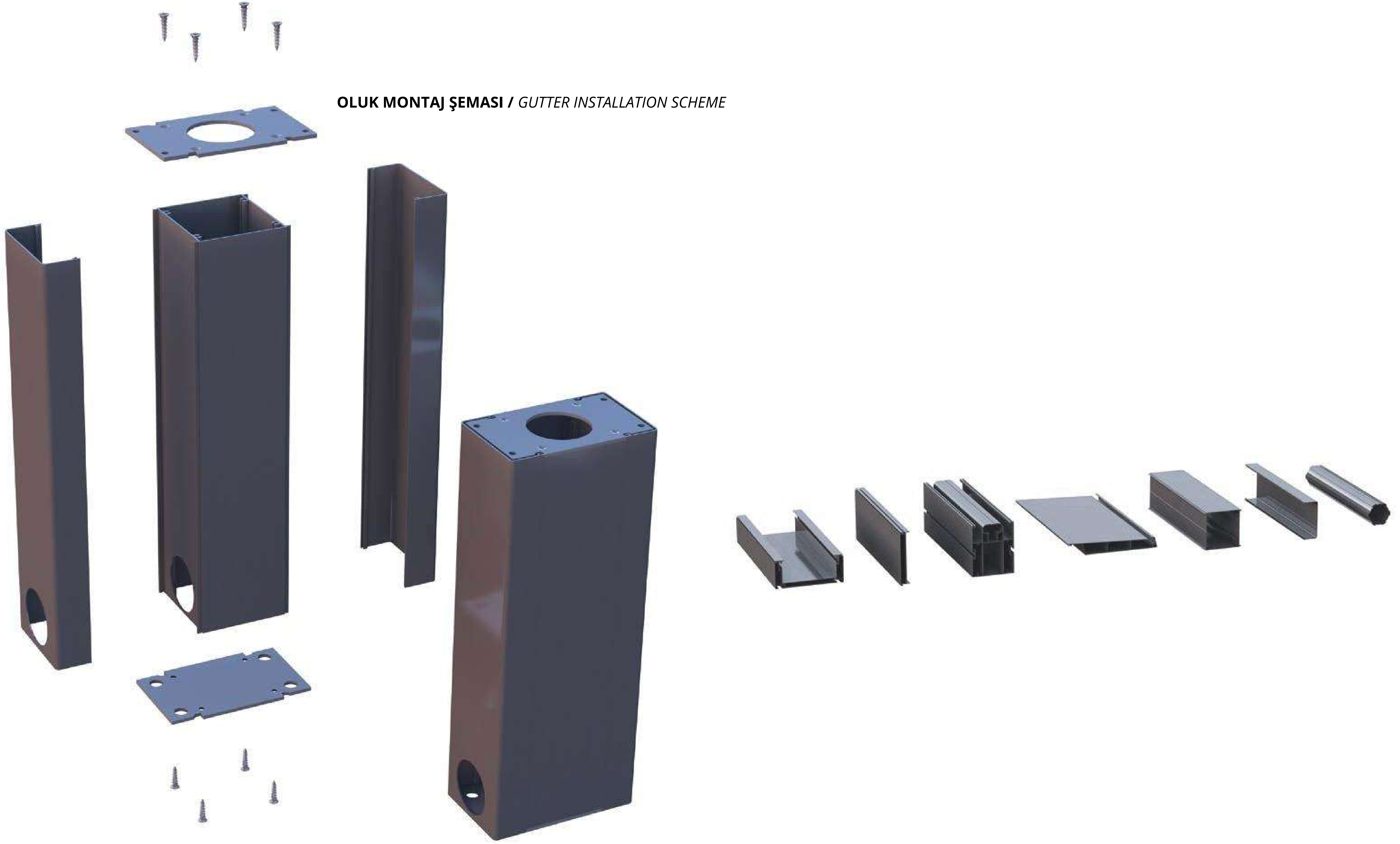





www.haggardconstruction.co.uk
293 Northfield Avenue, Ealing, London,
W5 4XB, United Kingdom

+44 7789 994837