

HOW TO SPECIFY

WESTERN RED CEDAR

- Siding
- Trim Boards
- Decking
- Timbers
- Fences & Gates



**REAL
CEDAR**



WESTERN RED CEDAR LUMBER ASSOCIATION

HERITAGE

Western Red Cedar's popularity dates back thousands of years to the Native Americans who first settled the Pacific Coast region of North America. Its versatility made the trees essential to Native peoples prompting them to revere it as a central part of their life. Western Red Cedar became known to them as the "Tree of Life".

Native craftsmen and artists found uses for each part of the Cedar tree. Craftsmen carved canoes, totem poles, storage boxes and ceremonial masks from the heartwood. Others wove the inner bark into mats, baskets and water repellent clothing, shaped the branches into ropes and fashioned the roots into baskets and cords.

This heritage continues today and is a testament to the quality and longevity of Western Red Cedar, a heritage that is unmatched by other building materials. As a buyer of Western Red Cedar, this is your assurance that Western Red Cedar will stand the test of time.

ENVIRONMENT

Western Red Cedar is the ultimate green building material. It is responsibly and sustainably harvested in the publicly managed forests of British Columbia, Canada. The province has exceeded United Nations guidelines by setting aside more than 12% of its land base as parkland. Less than 1/3 of 1% of BC's Cedar growing stock volume is harvested each year. For each tree harvested, three are replanted. The fact is, there are more forests in North America today than there were 100 years ago. These young forests are excellent carbon sinks. They also release oxygen back into the atmosphere contributing to a healthier environment.

All Western Red Cedar Lumber Association members are in the process or have achieved certification under one or more independent third party certification systems (CSA, SFI or FSC).

Wood, and Western Red Cedar specifically, has the least impact on the environment throughout its life cycle. Western Red Cedar requires significantly less energy to produce than other materials and unlike man-made alternatives, Western Red Cedar is biodegradable. Wood has 400 times better insulation (R) value than steel, 2000 times that of aluminum, 8 times that of concrete.

Make the right choice for your environment, build green with Western Red Cedar.



Why Western Red Cedar

Did you ever wonder why so many other products want to imitate Western Red Cedar? Western Red Cedar (*Thuja Plicata* in Latin) combines form and function like no other wood species or man-made material. Do not get misled by claims of other species using "cedar" in their name. Only Western Red Cedar has the unique, natural performance characteristics and exceptional beauty that bring warmth, character and longevity to homes and commercial buildings around the world. It is this bundle of properties that has made "Cedar" the material of choice for discerning architects, builders and homeowners.

Western Red Cedar is renowned for its naturally occurring resistance to moisture, decay and insect damage. Its natural durability, dimensional stability and exceptional beauty make it ideal for a wide variety of exterior and interior uses. It is lightweight and easy to handle and install for both the professional and do-it-yourselfer. Western Red Cedar offers enormous versatility. You are not limited by standard colours or styles as you are with many other products. With Western Red Cedar, the only limitation is your imagination.

When specifying materials for your next project, don't be disappointed, insist on Real Cedar. Insist on Western Red Cedar and include its Latin name, *Thuja Plicata* in your specification.



HOW TO SPECIFY

Western Red Cedar Siding

The exterior finish of a building is the face it presents to the world; it defines the mood and character of the structure and reflects the image desired by its designers, builders or owners.

Western Red Cedar siding is available in a range of designs and grades, offering the variety and versatility to complement any architectural style. It adapts equally well to bold and expressive modernism or the well defined criteria of period styling. Above all, Western Red Cedar has an enduring beauty that projects an aura of prestige. It is a wood with great dimensional stability and natural decay resistance. Its freedom from pitch and resin makes it an excellent base for a wide range of finishes.



BEVEL SIDING

Western Red Cedar bevel siding is the most widely used cedar siding type. It is produced by resawing lumber at an angle to produce two pieces thicker on one edge than the other. The manufacturing process results in pieces with one face saw textured. The other face is smooth or saw textured depending on the grade and customer preference. Bevel siding is installed horizontally and gives an attractive shadow line which varies with the thickness of siding selected.

Bevel siding is available in clear and knotty grades. Clear siding gives premium quality appearance and is ideal for prestigious, upmarket applications. Knotty siding has warmth and casual charm and is ideal for homes, cottages, club-houses and applications where a rustic appearance is desired.

WRCLA members also produce finger-joined bevel siding in clear and knotty grades. The precision-fitted joints are virtually invisible and stronger than the surrounding fiber. Finger-joined bevel siding is available in lengths up to 16 feet and provides the handsome appearance and all-weather performance of premium cedar siding. Builders appreciate both the convenient long length tally and the speed and ease of installation with fewer field joints.



SPECIFYING WESTERN RED CEDAR BEVEL SIDING

The following information is required when specifying bevel siding products:

Specification Information Required	Sample Specification
Species: Western Red Cedar	WRCLA Western Red Cedar
Product Pattern and Intended Use: Siding is used as an exterior cladding to provide both weather protection and architectural style. The designer may choose from plain bevel, rabbetted bevel, or wavy edge bevel.	Plain Bevel Siding
Size: Specify the nominal size of the product.	1/2 x 6 in.
Grade: The grade of the product governs its overall quality. Refer to WRCLA specification literature or grading agency rule books for available grades.	Clear V.G. Heart
Grading Agency Paragraph: To ensure that the product meets a written standard, an agency grade paragraph should be referenced.	NLGA para. 201a
Moisture Content: Specify whether the product is to be green (unseasoned) or kiln-dried.	Kiln-dried
Surface to be exposed: Specify the application orientation to assist the supplier in shipping the right product for the job.	Smooth face
Quantity: Express in surface measure the quantity required. See table opposite for factor to convert square feet to surface measure.	5500 surface measure

SIZES OF WESTERN RED CEDAR BEVEL SIDING

Nominal Size*	Pattern	Grades
Clear		
1/2x4		
1/2x6**		Clear V.G. Heart
1/2x8		A
11/16x6**	Plain Bevel	Rustic
11/16x8**		B
3/4x6		C
3/4x8		Proprietary
3/4x10		
Knotty		
5/8x6		
5/8x8		
11/16x6**		
11/16x8**		
11/16x10		
3/4x6	Plain Bevel	
3/4x8		
3/4x10		
7/8x8		
7/8x10		
7/8x12		Select Knotty Architect Knotty Proprietary
11/16x6**		
11/16x8**		
3/4x6	Rabbetted Bevel	
3/4x8		
3/4x10		
5/4x8		
5/4x10		
7/8x10	Wavy Edge Bevel	
7/8x12		

* Not all sizes are available in all grades.

** Available finger-joined.

BEVEL SIDING COVERAGE TABLE FOR SEASONED SIDINGS

Assuming minimum one inch overlaps*

Nominal Width (inches)	Dressed Width (inches)	Exposed Face Width (inches)	Linear Feet Factor	Surface Measure
4	3-1/2	2-1/2	4.80	1.60
6	5-1/2	4-1/2	2.67	1.33
8	7-1/2	6-1/2	1.85	1.23
10	9-1/2	8-1/2	1.41	1.18
12	11-1/2	10-1/2	1.14	1.14

*Larger overlaps can be used on wider bevel sidings such as 10 and 12 in. pieces. See WRCLA publication Installing Cedar Siding for more information.



Rabbetted bevel siding.





Bevel siding. Thickness measured at butt.

COVERAGE CALCULATION		EXAMPLE
1	Calculate total wall area (length x height)	Length x height = 160 square feet
2	Subtract square footage of openings (windows, doors) to determine wall area for siding	Door = -20 square feet Window = -20 square feet Area for siding = 120 square feet
3	Add 10% for trim	Plus 10% for trim = 120 + 12 = 132
4	Multiply figure by the appropriate factor for linear or surface measure	For 6 in. siding: 132 x 2.67 = 352.4 linear feet 132 x 1.33 = 175.6 surface measure

CLEAR GRADES OF WESTERN RED CEDAR BEVEL SIDING

Clear bevel siding is graded for smooth face use with the exception of Rustic which is graded for saw textured use only.



Grade	Description	Grading Rule Paragraph ¹
CLEAR VERTICAL GRAIN HEART*	 <p>This is the highest bevel siding grade. All Clear V.G. Heart grade is sawn vertical grain (edge grain) and is kiln-dried. Pieces have a smooth face of decay-resistant heartwood and are free from growth characteristics that affect appearance or performance. Pieces have excellent dimensional stability and hold finishes exceptionally well.</p>	NLGA 201a WCLIB 106-aa
A CLEAR*	 <p>This is a fine appearance grade that allows only slightly more growth characteristics than Clear Heart. Pieces are of mixed grain. These mixed grain (vertical and flat) pieces are graded from the surfaced face. Typically sold with a percentage of B grade (NLGA 201C/ WCLIB 106-b)</p>	NLGA 201b WCLIB 106-a
RUSTIC*	 <p>Rustic grade bevel siding is recommended for use as sidewall covering where the distinctive charm of a rustic saw textured appearance is desired. This grade allows limited characteristics that do not detract from serviceability.</p>	NLGA 201d WCLIB N/A

*Available solid wood or finger-joined

*Available solid wood or finger-joined

*Available solid wood or finger-joined

KNOTTY GRADES OF WESTERN RED CEDAR BEVEL SIDING

Grade	Description	Grading Rule Paragraph ¹	
SELECT KNOTTY		<p>Knots and other natural features define the visual character of knotty sidings. In Select Knotty grade, knots are sound and tight. Available rough or dressed, kiln-dried or unseasoned and smooth or saw textured. Some companies may supply this grade with knots glued on the reverse face. Typically a percentage of Quality Knotty grade (NLGA 205b/WCLIB 111-f).</p>	<p>NLGA 205a WCLIB 111-e</p>
ARCHITECT KNOTTY®		<p>This product is intended to be fully usable with the resawn face exposed to after trimming to fit the stud wall spacing. Contains no open characteristics or through defects. The product allows the use of adhesives on the reverse face to secure knots. Architect Knotty® is particularly well suited for factory priming or finishing. Supplied kiln-dried.</p>	<p>Proprietary WRCLA</p>

®Architect Knotty is a registered trademark of the WRCLA

¹NLGA – National Lumber Grades Authority

WCLIB – West Coast Lumber Inspection Bureau



PATTERN SIDINGS

The term pattern sidings describes a variety of siding products in which the board has been machined on the edge(s) and face(s) to produce siding with interlocking or overlapping joints and with smooth surfaced or rough sawn faces. These sidings fall into two broad groups: tongue and groove and lap.

TONGUE & GROOVE

Western Red Cedar tongue and groove is widely used for its good looks and versatility. It can be installed horizontally, vertically or diagonally, each method giving a distinctly different look. Tongue and groove siding is available with rough or smooth faces. Both seasoned (kiln-dried) and unseasoned (green) sidings are available.

The joints between adjoining pieces are usually v-shaped or flush jointed, reveal and radius joints are also available. The different joints and surface textures in tongue and groove siding combine to provide a range of shadow line effects that enhance the product's versatility.

Tongue and groove siding is manufactured in clear grades suitable for a more formal, elegant appearance, particularly when pieces are smooth faced. Knotty grades are in demand for their smart, casual look.

SPECIFYING WESTERN RED CEDAR TONGUE & GROOVE

The following information is required when specifying tongue and groove siding products:

Specification Information Required	Sample Specification
Species: Western Red Cedar	WRCLA Western Red Cedar
Product Pattern and Intended Use: Siding is used as an exterior cladding to provide both weather protection and architectural style. The designer may choose from Edge V one side (EV1S) WRCLA1, Edge V two sides (EV2S), WRCLA2, or specific pattern number.	Tongue and Groove EV1S - WRCLA1
Size: Specify the nominal size of the product.	1 x 6 in.
Grade: The grade of the product governs its overall quality. Refer to WRCLA specification literature or grading agency rule books for available grades.	Select Knotty
Grading Agency Paragraph: To ensure that the product meets a written standard, an agency grade paragraph should be referenced.	NLGA para. 204a
Moisture Content: Specify whether the product is to be green (unseasoned) or kiln-dried.	Kiln-dried
Surface to be exposed: Specify the application orientation to assist the supplier in shipping the right product for the job.	Sawn face
Quantity: Express in board feet the quantity required. See table opposite for factor to convert square feet of wall area to board feet.	5500 board feet

SIZES OF WESTERN RED CEDAR TONGUE AND GROOVE SIDING

		Finished	
	Nominal	Green	Dry
Thickness (in.)	1	3/4	11/16
Widths (in.)	4,6,8	3-9/16, 5-1/2, 7-3/8	3-3/8, 5-3/8 7-1/8



V-Joint on two sides (EV2S) WRCLA2



V-Joint on one side (EV1S) WRCLA1



Flush Joint (S2S)

OTHER TONGUE AND GROOVE SIDING PATTERNS



WP-6



102



106

Pattern numbers from the Western Wood Products Association publication Standard Patterns

TONGUE AND GROOVE SIDING COVERAGE TABLE FOR GREEN (UNSEASONED) SIDING

Nominal Width (inches)	Dressed Width (inches)	Exposed Face Width (inches)	Linear Feet Factor	Board Feet Factor
4	3-3/8	3	4.00	1.33
6	5-3/8	5	2.40	1.20
8	7-1/8	6-3/4	1.77	1.19

See Bevel Siding section for guide to using coverage table.



LAP SIDINGS

Lap sidings are supplied in a variety of patterns in clear or knotty grades and with a smooth or saw textured face

Channel siding is a popular type of lap siding and is used whenever a rustic appearance is desired. A versatile siding, it can be installed vertically, horizontally or diagonally. In channel siding the profile of each board partially overlaps that of the board next to it creating a channel that gives shadow line effects, provides excellent weather protection and allows for dimensional movement.

Channel siding is normally supplied in unseasoned knotty grades. The face side is saw textured. Commonly available sizes are 1 x 6 in., 1 x 8 in. and 1 x 10 in. Clear grades are manufactured to order.

SPECIFYING WESTERN RED CEDAR LAP SIDING

The following information is required when specifying lap siding products

Specification Information Required	Sample Specification
Species: Western Red Cedar	WRCLA Western Red Cedar
Product Pattern and Intended Use: Siding is used as an exterior cladding to provide both weather protection and architectural style. The designer may choose from a variety of lap siding patterns specified by name or pattern number.	Lap Siding Pattern WP11
Size: Specify the nominal size of the product.	1 x 6 in.
Grade: The grade of the product governs its overall quality. Refer to WRCLA specification literature or grading agency rule books for available grades.	Select Knotty
Grading Agency Paragraph: To ensure that the product meets a written standard, an agency grade paragraph should be referenced.	NLGA para. 204a
Moisture Content: Specify whether the product is to be green (unseasoned) or kiln-dried.	Green
Surface to be exposed: Specify the application orientation to assist the supplier in shipping the right product for the job.	Sawn face
Quantity: Express in board feet the quantity required. See table opposite for factor to convert square feet of wall area to board feet.	5500 board feet

LAP SIDING COVERAGE TABLE FOR GREEN (UNSEASONED) SIDING

Nominal Width (inches)	Dressed Width (inches)	Exposed Face Width (inches)	Linear Feet Factor	Board Feet Factor
6	5-1/2	4-3/4	2.53	1.27
8	7-3/8	6-5/8	1.81	1.21
10	9-3/8	8-5/8	1.39	1.16

See Bevel Siding section for guide to using coverage table.



Channel Siding

OTHER LAP SIDING PATTERNS



WP-11



101

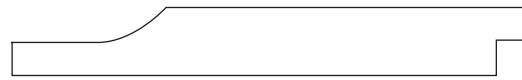

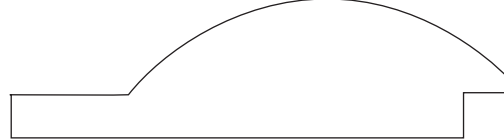

105



Log Cabin

Pattern numbers from the Western Wood Products Association publication Standard Patterns.

CLEAR GRADES OF WESTERN RED CEDAR PATTERN SIDING

Grade	Description	Grading Rule Paragraph ¹
<p>CLEAR HEART</p> 	<p>The highest grade. Includes only pieces with heartwood on the exposed face. Many pieces completely clear, others have minor imperfections that do not detract from their fine appearance.</p>	<p>NLGA 200a WCLIB 102-b</p>
<p>A CLEAR</p> 	<p>Permits somewhat more imperfections than Clear Heart but the grade is still restricted to pieces with excellent appearance. Typically sold with a percentage of B grade (NLGA 200c/WCLIB 102-d).</p>	<p>NLGA 200b WCLIB 102-c</p>

KNOTTY GRADES OF WESTERN RED CEDAR PATTERN SIDING

Grade	Description	Grading Rule Paragraph ¹
SELECT KNOTTY	Available kiln-dried or unseasoned. Knots are sound and tight. Typically sold with a percentage of Quality Knotty grade (NLGA 204b/WCLIB 111-f).	NLGA 204a WCLIB 111-e



PROPRIETARY GRADES*



Designed to meet appearance requirements for cedar sidings and trim. Ask your WRCLA distributor for details.

NLGA N/A
WCLIB N/A

*Manufacturers may market their own proprietary grades.



BOARD-AND-BATTEN SIDING

Board-and-batten is a vertical design created using wide clear or knotty cedar boards spaced apart with narrower boards (battens) covering the joins. There are no set board or batten widths – various combinations are used to create different looks suitable for large or small scale applications. A frequent combination is 1 x 3 in. battens and 1 x 10 in. boards. This can also be reversed with boards installed over battens to create a deep channel effect.

Rough sawn, unseasoned boards or boards surfaced on one side and two edges (S1S2E) are commonly used for board-and-batten siding. Sizes are from 1 x 2 in. to 1 x 12 in.

SPECIFYING WESTERN RED CEDAR BOARD-AND-BATTEN SIDING

The following information is required when specifying board-and-batten siding:

Specification Information Required	Sample Specification
Species: Western Red Cedar	WRCLA Western Red Cedar
Product Pattern and Intended Use: Siding is used as an exterior cladding to provide both weather protection and architectural style. The designer may choose from clear or knotty, kiln-dried or green (unseasoned), rough sawn or surfaced on one side and two edges (S1S2E).	S1S2E Boards
Size: Specify the nominal size of the product.	1 x 3 in. Battens 1 x 10 in. Boards
Grade: The grade of the product governs its overall quality. Refer to WRCLA specification literature or grading agency rule books for available grades.	A and Better
Grading Agency Paragraph: To ensure that the product meets a written standard, an agency grade paragraph should be referenced.	NLGA para. 200a, b
Moisture Content: Specify whether the product is to be green (unseasoned) or kiln-dried.	Kiln-dried
Surface to be exposed: Specify the application orientation to assist the supplier in shipping the right product for the job.	Sawn face
Quantity: Express in linear feet	10,000 linear feet 1 x 3 in. 10,000 linear feet 1 x 10 in.

SIZES OF WESTERN RED CEDAR BOARDS FOR BOARD-AND-BATTEN SIDING

Thickness (in.)			Width (in.)		
Nominal	Actual		Nominal	Actual	
	Dry	Green		Dry	Green
Rough					
1	3/4	3/4	2	1-3/4	2
	13/16	13/16	3	2-3/4	3
	7/8	7/8	4	3-3/4	4
5/4	1-1/8	1-1/8	6	5-3/4	6
			8	7-3/4	8
			10	9-3/4	10
			12	11-3/4	12
Surfaced One Side Two Edges (S1S2E)					
1	11/16	11/16	2	1-1/2	1-9/16
	7/8	3/4	3	2-1/2	2-9/16
		13/16	4	3-1/2	3-9/16
		7/8	6	5-1/2	5-9/16
5/4	1	1-1/32	8	7-1/4	7-3/8
2	1-1/2	1-1/2	10	9-1/4	9-3/8
			12	11-1/4	11-3/8
Surfaced Four Sides (S4S)					
1	11/16	3/4	2	1-1/2	1-9/16
	7/8	3/4	3	2-1/2	2-9/16
		13/16	4	3-1/2	3-9/16
		7/8	6	5-1/2	5-9/16
5/4	1	1-1/32	8	7-1/4	7-3/8
2	1-1/2	1-9/16	10	9-1/4	9-3/8
			12	11-1/4	11-3/8

BOARD-AND-BATTEN SIDING COVERAGE TABLE

Nominal Width (inches)	Dressed Width (inches)	Exposed Face Width (inches)
2	1-9/16	Varies with width of board selected
4	3-9/16	
6	5-9/16	
8	7-3/8	
10	9-3/8	
12	11-3/8	

See Bevel Siding section for guide to using coverage table.

Linear Feet Factor = Exposed Face Width/12 in.

Board Foot Factor = Nominal Width/Exposed Face Width

*** For Boards-and-Patten Grades see Trim Boards on page 24 & 25**



HOW TO SPECIFY

Western Red Cedar Trim Boards

Real wood trim on the exterior of residential, commercial or industrial buildings perfectly complements any architectural style and is compatible with all contemporary cladding materials. The ideal wood for exterior trim is Western Red Cedar. Its dimensional stability, longevity, ability to accept a wide range of finishes, resistance to decay, and natural good looks make it the only sensible choice for corner boards, fascia, skirting and window and door trim.



CHOICES TO SUIT YOUR STYLE

Western Red Cedar trim boards are available in a variety of grades and textures to complement the style you have envisioned. Clear boards have a limited number of natural characteristics and are specified when “clean”, fine appearance of the highest quality is desired. They are available kiln dried or unseasoned. Knotty boards present a more rustic appearance and may be specified seasoned or unseasoned. Texture options of rough, surfaced one side, two edges and surfaced on four sides further enhance your design flexibility.

SPECIFYING CEDAR WESTERN RED TRIM BOARDS

The following information is required when specifying trim boards:

Specification Information Required	Sample Specification
Species: Western Red Cedar	WRCLA Western Red Cedar
Product Pattern and Intended Use: Trim boards are generally used in applications such as corner boards, fascia, skirting, and detail around windows and doors. Specify the surface finish by choosing surfaced four sides (S4S) surfaced one side and two edges (S1S2E), or rough sawn all round (rough).	S1S2E Boards
Size: Specify the nominal size of the product.	1 x 6 in.
Grade: The grade of the product governs its overall quality. Refer to WRCLA specification literature or grading agency rule books for available grades.	Select Knotty
Grading Agency Paragraph: To ensure that the product meets a written standard, an agency grade paragraph should be referenced.	NLGA paragraph 200a, b
Moisture Content: Specify whether the product is to be green (unseasoned) or kiln-dried.	Green
Surface to be exposed: Specify the application orientation to assist the supplier in shipping the right product for the job.	Resawan face
Quantity: Express in linear feet	2,000 linear feet

AVAILABLE SIZES

Western Red Cedar trim boards are available in the sizes shown in the following table.

SIZES OF WESTERN RED CEDAR TRIM BOARDS

Thickness (in.)			Width (in.)		
Nominal	Actual		Nominal	Actual	
	Dry	Green		Dry	Green
Rough					
1	3/4	3/4	2	1-3/4	2
	13/16	13/16	3	2-3/4	3
	7/8	7/8	4	3-3/4	4
5/4	1-1/8	1-1/8	6	5-3/4	6
			8	7-3/4	8
			10	9-3/4	10
			12	11-3/4	12
Surfaced One Side Two Edges (S1S2E)					
1	11/16	11/16	2	1-1/2	1-9/16
	7/8	3/4	3	2-1/2	2-9/16
		13/16	4	3-1/2	3-9/16
		7/8	6	5-1/2	5-9/16
5/4	1	1-1/32	8	7-1/4	7-3/8
2	1-1/2	1-1/2	10	9-1/4	9-3/8
			12	11-1/4	11-3/8
Surfaced Four Sides (S4S)					
1	11/16	3/4	2	1-1/2	1-9/16
	7/8	3/4	3	2-1/2	2-9/16
		13/16	4	3-1/2	3-9/16
		7/8	6	5-1/2	5-9/16
5/4	1	1-1/32	8	7-1/4	7-3/8
2	1-1/2	1-9/16	10	9-1/4	9-3/8
			12	11-1/4	11-3/8

KILN DRIED CLEAR GRADES OF WESTERN RED CEDAR TRIM BOARDS GRADES AS FINISH LUMBER. TYPICALLY AVAILABLE AS S4S OR SIS2E PRODUCTS.

Grade	Description	Grading Rule Paragraph ¹
-------	-------------	-------------------------------------

CLEAR HEART



The highest grade. Includes only pieces with heartwood on the exposed face. Many pieces completely clear, others have minor imperfections that do not detract from their fine appearance.

NLGA 200a
WCLIB 102-b

A CLEAR



Permits somewhat more imperfections than Clear Heart but the grade is still restricted to pieces with excellent appearance. Typically sold with a percentage of B grade (NLGA 200c/WCLIB 102-d).

NLGA 200b
WCLIB 102-c

UNSEASONED CLEAR GRADES OF WESTERN RED CLEAR TRIM BOARDS. TYPICALLY AVAILABLE AS ROUGH OR SIS2E PRODUCTS.

C AND BETTER CLEAR



High quality lumber for use where appearance is important. In addition to interior and exterior trim, lumber of this grade is used for cabinetry, doors, windows and similar applications.

NLGA 202b, c
WCLIB 149-b, c
WWPA 10.11, 12

D CLEAR



This grade permits larger and more numerous natural characteristics and is used where general utility is more important than appearance.

NLGA 202d
WCLIB 149-b, c
WWPA 10.13

¹NLGA – National Lumber Grades Authority
WCLIB – West Coast Lumber Inspection Bureau
WWPA – Western Wood Products Association

UNSEASONED OR SEASONED KNOTTY GRADES OF WESTERN RED CLEAR TRIM BOARDS.

Grade	Description	Grading Rule Paragraph ¹
SELECT KNOTTY*	Knots are sound and tight. Other characteristics are limited so they do not detract from the end use intended. Typically sold with a percentage of Quality Knotty grade (NLGA 204b/WCLIB 111-f).	NLGA 204a WCLIB 111-e
PROPRIETARY	Graded to the manufacturer's specifications to meet the intended end use. Boards often represent good value in the no-hole product range. Consult manufacturers for grade descriptions and nomenclature.	NLGA N/A WCLIB N/A





HOW TO SPECIFY

Western Red Cedar Decking

A deck made with Western Red Cedar, one of the world's most beautiful woods, is apt to be one of the best looking decks in the neighborhood. But Western Red Cedar decks have much more going for them than good looks alone. Extending living space to the outdoors, integrating home and landscape, making use of damp or uneven terrain and giving a contemporary look to a traditionally-styled home are just a few of the ways that decks make life a little better.

SPECIFYING WESTERN RED CEDAR DECKING

To simplify specification, decking is now available in four grade categories offered exclusively by members of the Western Red Cedar Lumber Association. These few easily understood categories of decking provide a choice of quality clear grades or rustic knotty grades for outdoor decks of any style and budget.

Once the decision is made to build a deck, the choice of decking material is just as important as good design and quality construction. In today's environmentally conscious society, the natural choice is Western Red Cedar.

All wood used in the outdoors must be protected against decay and insect attack. Not only is Western Red Cedar one of the few woods with its own preservative oils, its freedom from pitch and resin makes it an excellent base for protective coatings. And cedar has other natural qualities that make it the best choice for decking. It is the most stable of British Columbia's softwoods, so Western Red Cedar decks stay flat and straight and resist checking.

Western Red Cedar decks are firm but resilient underfoot, not hard and unyielding. The wood is light weight, easily worked and ideal for almost all types of finishes. It has an elegance that complements any architectural style and a beauty that blends into all landscapes.

Whatever the reasons for building a deck, there is just one natural choice of decking material. Available in a wide range of grades and sizes, and price-competitive with lesser materials, Western Red Cedar decks are the beautiful, practical, long-lasting complement to any home.

The following information is required when specifying decking:

Specification Information Required	Sample Specification
Species: Western Red Cedar	WRCLA Western Red Cedar
Size: Specify the size of decking.	5/4 x 6
Grade: The grade of decking governs its overall quality. Refer to following pages for available grades.	WRCLA Custom Clear
Moisture Content: Specify whether the product is to be seasoned on unseasoned	Unseasoned
Quantity: Express in linear feet	1000

SIZES AND SPANS OF WESTERN RED CEDAR DECKING

WRCLA Western Red Cedar decking is available in a selection of thicknesses, widths and lengths as shown in the table opposite.

Maximum spans for decking shown in the table are based on a continuous beam with two equal spans and a concentrated load of 220-lb at the center of one span. The true span of the decking board is used, taking into account the thickness of the supporting joist beneath it. Wet end-use conditions and unseasoned (green) lumber sizes are assumed.

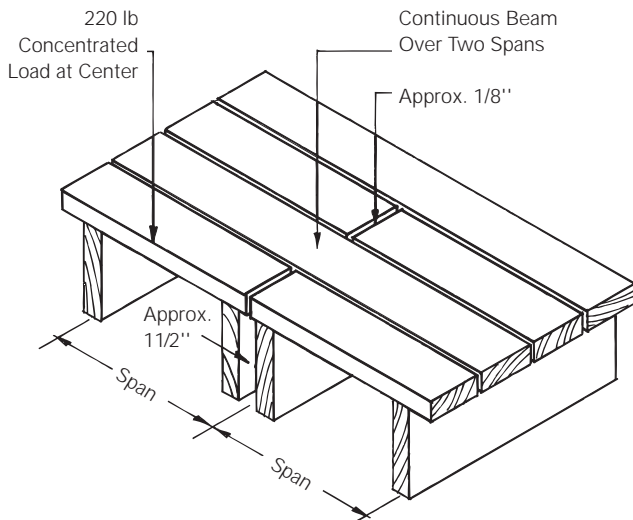

Thickness (in.)	Width (in.)	Grade Category (in.)	Span
1-1/4	4	All clear grade categories	16
1-1/4	4	All knotty grade categories	12
1-1/4	6	All clear and knotty grade categories	16
2	4	All clear and knotty grade categories	24
2	6	All clear and knotty grade categories	24

To help figure the amount of decking needed for a project, use the following linear footage calculator:

To Cover 100 Square Feet of Deck	
Nominal Size (in.)	Linear Feet
1-1/4 x 4	325
2 x 4	325
1-1/4 x 6	211
2 x 6	211

BUILDING AND MAINTENANCE TIPS



Space deck boards apart to allow proper water drainage. A deck that dries after wetting will last longer than one that stays damp.

Keep the deck free of leaf, pine needle and other debris build-ups. These can retain water and clog drainage channels resulting in a deck that cannot drain and dry properly after wetting.

Moisture and debris can collect where butt joints occur over-joists. To create drainage, butt decking boards between double joists as shown, leaving a 1/8-in. space between the ends of the boards.



Move planters, benches and other deck accessories from-time to time to allow the deck under them to dry thoroughly.

CLEAR GRADES OF WESTERN RED CEDAR DECKING

Grade	Description
<p>ARCHITECT CLEAR™</p> 	<p>The ultimate in durability and appearance. Its fine grained heartwood appearance will meet the needs of the most demanding clients. All aspects of manufacturing and quality control are performed to the highest standards of the lumber industry. Architect Clear decking should be specified when only the best will suffice. This exclusive product is usually manufactured to individual order. Available seasoned or unseasoned.</p>
<p>CUSTOM CLEAR™</p> 	<p>A quality product that combines the stability and durability of Western Red Cedar with a sophisticated clear appearance that will please the most discriminating taste. Its finely machined surface shows limited characteristics which do not detract from its natural good looks. Custom Clear decking can be used directly on the job and is a natural for custom residences and other applications where fine woodworking is desired. Available seasoned or unseasoned.</p>

In addition to these clear grades, some suppliers will also offer clear grades of A & Better, C, and D & Better S4S for decking purposes.

KNOTTY GRADES OF WESTERN RED CEDAR DECKING

<p>ARCHITECT KNOTTY™</p> 	<p>Rustic charm at its best. Durable, well manufactured Western Red Cedar decking that comes ready to use. This sound and tight-knotted decking limits both the size and quality of characteristics to meet the highest buyer expectations. The smooth, skip-free dressing over the entire face makes it the ideal deck surface. The top choice where the natural beauty and lasting charm of a knotty deck are desired. Available seasoned or unseasoned.</p>
<p>CUSTOM KNOTTY™</p> 	<p>Widely used by homeowners and builders, this category of knotty decking combines the high manufacturing standards required for deckboards with a hole-free knotty appearance. This category limits the size and quality of characteristics to provide an economical and enjoyable knotty deck. Custom Knotty decking may be applied as received and is a natural choice for home deck builders, residential builders, and commercial applications where a durable knotty material is desired. Available unseasoned only.</p>





HOW TO SPECIFY

Western Red Cedar Timbers

Western Red Cedar timbers are suitable for a broad range of functional and decorative applications. They can be used in engineered structures including commercial, industrial and residential buildings. However, the beauty of Western Red Cedar and its natural durability and performance mean that it is the ideal product for use in landscape design and construction.



TIMBER CONSTRUCTION & LANDSCAPE STRUCTURES

In general, applications can be classified into two broad end use groups: first, for those structures such as large buildings in which both the strength and the appearance of exposed wood members are of equal importance; and second, in landscape, park and garden structures where appearance is paramount.

For both use-groups, Western Red Cedar offers the advantages of natural beauty, design flexibility, exceptional dimensional stability and long term durability. Cedar has a long history of withstanding the rigors of time and weather. It is also a recognized structural material with known mechanical and physical properties (see WRCLA publication Designer's Handbook). These attributes allow the design of timber structures of all types using basic engineering principles and stress- or appearance - rated grades of Western Red Cedar.

SPECIFYING WESTERN RED CEDAR TIMBERS

Clear Grades - Clear cedar in the grades shown on the following pages has a limited number of natural characteristics and is specified when appearance of the highest quality is desired. Clear grades of timbers are normally supplied green (unseasoned). When required, seasoning is achieved by air-drying.

Knotty Grades - Knotty cedar presents a more rustic appearance and is typically supplied green (unseasoned) in the appearance and structural grades shown on the following pages.

GRADE CLASSIFICATIONS

Depending on size, Western Red Cedar timbers are classified either as Beams and Stringers or Posts and Timbers.

Beams and Stringers are rectangular members, either rough sawn or surfaced, 5 inches and thicker with a width 2 inches (or more) greater the width.

Posts and Timbers are square members, either rough sawn or surfaced, 5 inches by 5 inches and larger with a width not more than 2 inches greater than the thickness.

SIZES OF WESTERN RED CEDAR

Grades of Beams and Stringers and Posts and Timbers are available in a selection of widths and thicknesses showing the following table. Standard lengths are multiples of one foot, typically up to 20'. Longer length timbers are available on a special order basis.

Thickness and Width (inches) by Size Options			
Nominal	Full Sawn	Standard	Surfaced
4		3 3/4	3 9/16
5			4 1/2
6	6	5 3/4	5 1/2
8	8	7 3/4	7 1/2
10	10	9 3/4	9 1/2
12	12	11 3/4	11 1/2
Over 12	as nominal	1/4 off nominal	1/2 off nominal

SPECIFYING WESTERN RED CEDAR FOR TIMBERS

The following information is required when specifying timbers:

Specification Information Required	Sample Specification
Species: Western Red Cedar	WRCLA Western Red Cedar
Product Pattern and Intended Use: Timbers are used in many structures such as commercial, industrial and residential buildings; and in engineered and landscape structures. Specify the surface finish by choosing Surfaced Four Sides (S4S) rough sawn or rougher headed	Rough Sawn
Size: Specify the nominal size of the product.	6x8 Standard Sawn
Grade: The grade of the product governs its overall quality. Refer to WRCLA specification literature or grading agency rule books for available grades.	Appearance Knotty
Grading Agency Paragraph: To ensure that the product meets a written standard, an agency grade paragraph should be referenced.	Meeting NLGA/WCLIB para. 130cc upgraded for appearance qualities
Moisture Content: Specify whether the product is to be green (unseasoned) or kiln-dried.	Green
Surface to be exposed: Specify the application orientation to assist the supplier in shipping the right product for the job.	Sawn face
Quantity: Express in linear feet	2,000 linear feet

GRADES OF WESTERN RED CEDAR TIMBERS

Grade	Description	Grading Rule Paragraph ¹
-------	-------------	-------------------------------------

NO. 2 AND BETTER CLEAR



This grade should be specified when the finest quality rough lumber is desired. The lumber is sound and well manufactured. Its natural characteristics do not detract from the wood's fine appearance.

Export R List 401

D AND BETTER CLEAR



The C and better Clear grade offers good appearance in high quality, well manufactured lumber. Suitable for high quality landscape structures and as exposed posts and beams in heavy timber construction. In most cases, this grade is sold with a specified allowance of D grade.

NLGA 203 b,c,d
WCLIB 150 b,c,d

D Clear grade permits larger and more numerous natural characteristics which are widely accepted in the construction of outdoor structures. Some pieces of D Clear may require trimming to yield lengths for the intended use.

APPEARANCE KNOTTY



A non structural product manufactured to meet the appearance requirements of quality projects. This materials has highly restricted wane allowances to give well defined corners. Contains no holes or other characteristics. Represents good value for appearance end uses. Available rough sawn or rougher headed in nominal 2" and thicker sizes.

Proprietary

Note: Upon request, Appearance Knotty timbers are available with structural grading. Be certain to specify Appearance Knotty structural lumber when strength characteristics are required.

Grade	Description	Grading Rule Paragraph ¹
-------	-------------	-------------------------------------

NO. 2 AND BETTER STRUCTURAL



Material of this grade is evaluated for structural strength characteristics. The classification includes pieces meeting the grades of Select structural, No.1 Structural, and No.2 Structural. Lumber of this grade is intended for engineered applications where strength is more important than appearance. Available surfaced or rough textured.

5" and thicker, with more than 2" greater than thickness
 NLGA 130 a,b,c
 WCLIB 130 a,b,c
 WWPA 70.10
 Width less than 2" greater than thickness
 NLGA 131 a,b,c
 WCLIB 131 a,b,c
 WWPA 80.10

* Graded as Light Framing
 ** Graded a Structural Joists and Planks

STANDARD BEAMS, POSTS AND TIMBERS



Timbers of this grade are intended for general construction purposes where serviceability is more important than appearance. No Structural values are assigned. Available surfaced or rough textured.

5" and thicker
 NLGA 131 c
 WCLIB 131 c
 WWPA 81.11

NLGA - National Lumber Grades Authority
 WCLIB - West Coast Lumber Inspection Bureau
 WWPA - Western Wood Products Association
 R List - Export R List (applies to rough sawn/rougher beaded lumber)



HOW TO SPECIFY

Western Red Cedar Fences & Gates

Western Red Cedar fences are not only beautiful, they also offer outstanding performance. Whether you choose custom built or pre-built panels, Western Red Cedar fences will outperform other materials without the need for chemical treatments. Western Red Cedar is naturally durable and has a low percentage of sapwood which means it will stand up to the elements longer than other woods. The beauty of Western Red Cedar is often imitated but nothing can match the warmth and character of the real thing. When designing and specifying fencing materials, don't settle for anything but Real Cedar, Western Red Cedar.

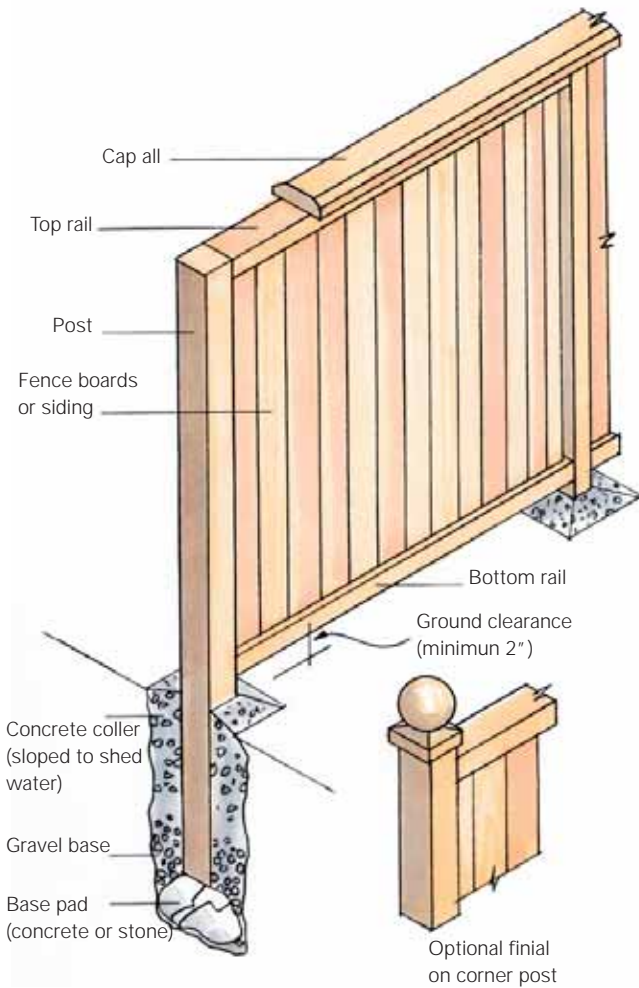

BASIC ELEMENTS OF FENCE CONSTRUCTION

Most fences are constructed with three basic elements: post, rails and infill material. Posts are vertical uprights. Rails run horizontally between, and are supported by the posts. Infill material, most commonly boards, are attached to the rails. For each of these elements there is a size and grade of Western Red Cedar to build just about any style of fence on any budget. Remember, it doesn't necessarily cost more to have a stylish fence. This brochure will help you choose the right cedar product for the job and stay within your budget.

Here's a checklist of points you should consider when planning a fence:

- Choose a style that suits both the purpose of the fence and the landscape, then maintain consistency of style throughout.
- Decide whether you'll build the fence from scratch or from ready-made fencing sections.
- Select from rough or surfaced material for posts, rails and boards.
- Select solid boards with flat tops or choose from a variety of patterned-top boards such as pointed, dog-eared, gothic, spearhead, roundtop and others.
- Decide whether short length pattern siding such as channel or tongue and groove V-joint will achieve the look you want.
- Consider using lattice panels alone or in combination with solid boards where a lighter, more open fence is desired.
- Decide on the type of finish. Transparent or semi-transparent stains are suggested if a natural look is desired. Solid color stains are recommended if an opaque finish is desired.

TYPICAL PATTERNED-TOP BOARDS



BASIC ELEMENTS OF GATE CONSTRUCTION

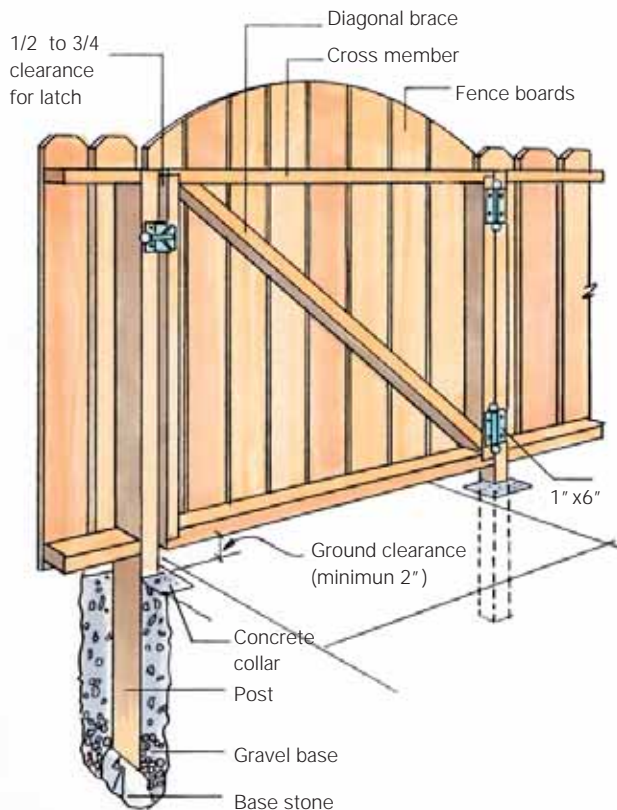

- Locate the gate for convenient entry as it relates to paths, driveways and the general landscaping plan.
- Decide upon the width of the gate. It should be wide enough for two people to pass through side by side and allow clear passage for garden equipment such as lawnmowers and wheelbarrows. Note that gates wider than 4 feet are hard to support and tend to sag. Consider a two-section gate for wide openings.
- Determine whether the gate should slide or swing. If a swing gate, establish an unimpeded direction of swing. A gate usually swings in towards the property except on sloping ground where it should swing downhill to avoid having to cut the bottom of the gate at an angle.
- Locate the gate at the top of steps rather than at the bottom and make it swing away from the steps for safety's sake.
- Build the gate solidly and attach it with good quality hardware.

WESTERN RED CEDAR GATES

Western Red Cedar gates make great first impressions. They convey a sense of welcome to visitors yet add an extra measure of privacy and security to the property without being oppressive in appearance.

The type of fence you have decided to build will have a bearing on your choice of gates. Like fences, gates can take many shapes and sizes but they should meet two main requirements: they should be in harmony with the fence and they must function effectively.

The various sizes, grades and textures of cedar recommended in this booklet for fence building are also suitable for gates. By using materials of the same quality and texture, you can maintain design continuity and bring fence and gate into harmonious balance.

Here's a short checklist of points to consider when planning a gate:

- Choose a style that complements the fence and maintains design and material continuity.

FENCE HARDWARE

Many different types of hardware are now available to help you build your fence. Popular among these are metal post supports in the form of a 4x4 in. box atop long fins two feet or more in length which are driven into the ground. Posts are set directly into the box and fastened with bolts or lag screws. By using these post supports you can eliminate post-hole digging and concreting. Another popular form of post base is a 4x4 in. metal saddle which can be set on a concrete pad and to which the post can be nailed or lag screwed. You can also use metal saddles to connect railing posts to a wood deck. One easy way to secure fence rails to posts and to simplify corner attachments, is to use aluminum or galvanized metal brackets similar to joist hangers.

GATE HARDWARE

Gate hardware usually consists of hinges, latches, barrel bolts, and tension supports or sag rods. Whatever hardware you select from among the wide range available, make sure that it is sturdy enough to withstand constant use and that it is rust and corrosion-resistant.

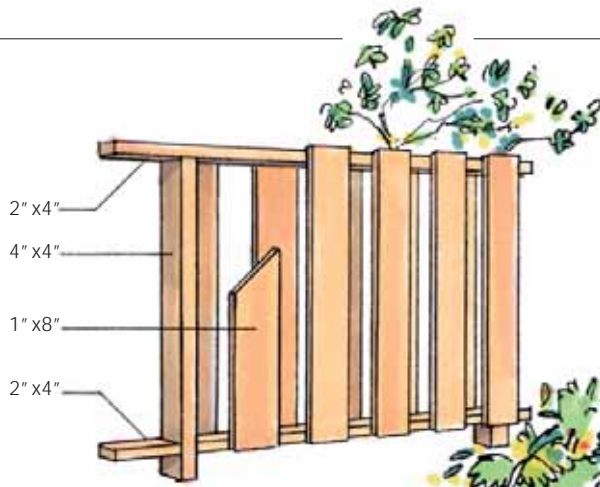

**MATCHING BOARDS
BOTH SIDES**



**MATCHING BOARDS
ALTERNATE SIDES**



**PANELS ON
ALTERNATE SIDES**



**ALTERNATE VERTICAL
AND HORIZONTAL PANELS**

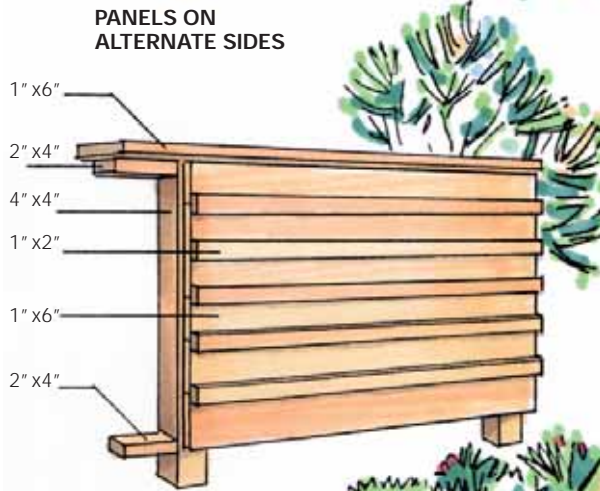

**HORIZONTAL
BOARD-AND-BATTEN**

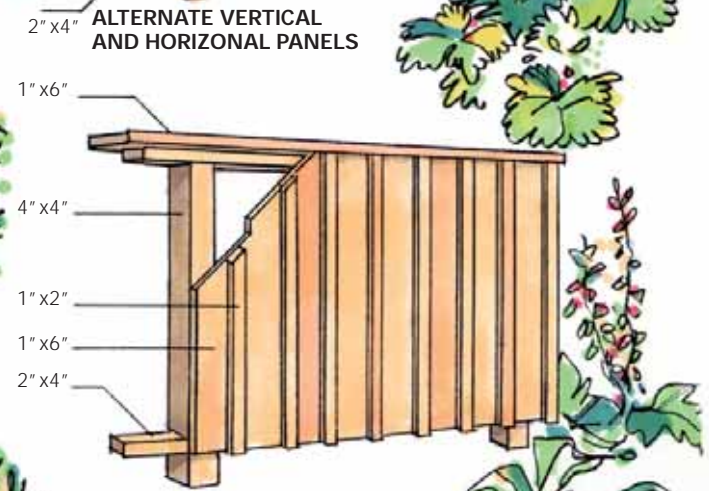

VERTICAL BOARD-AND-BATTEN

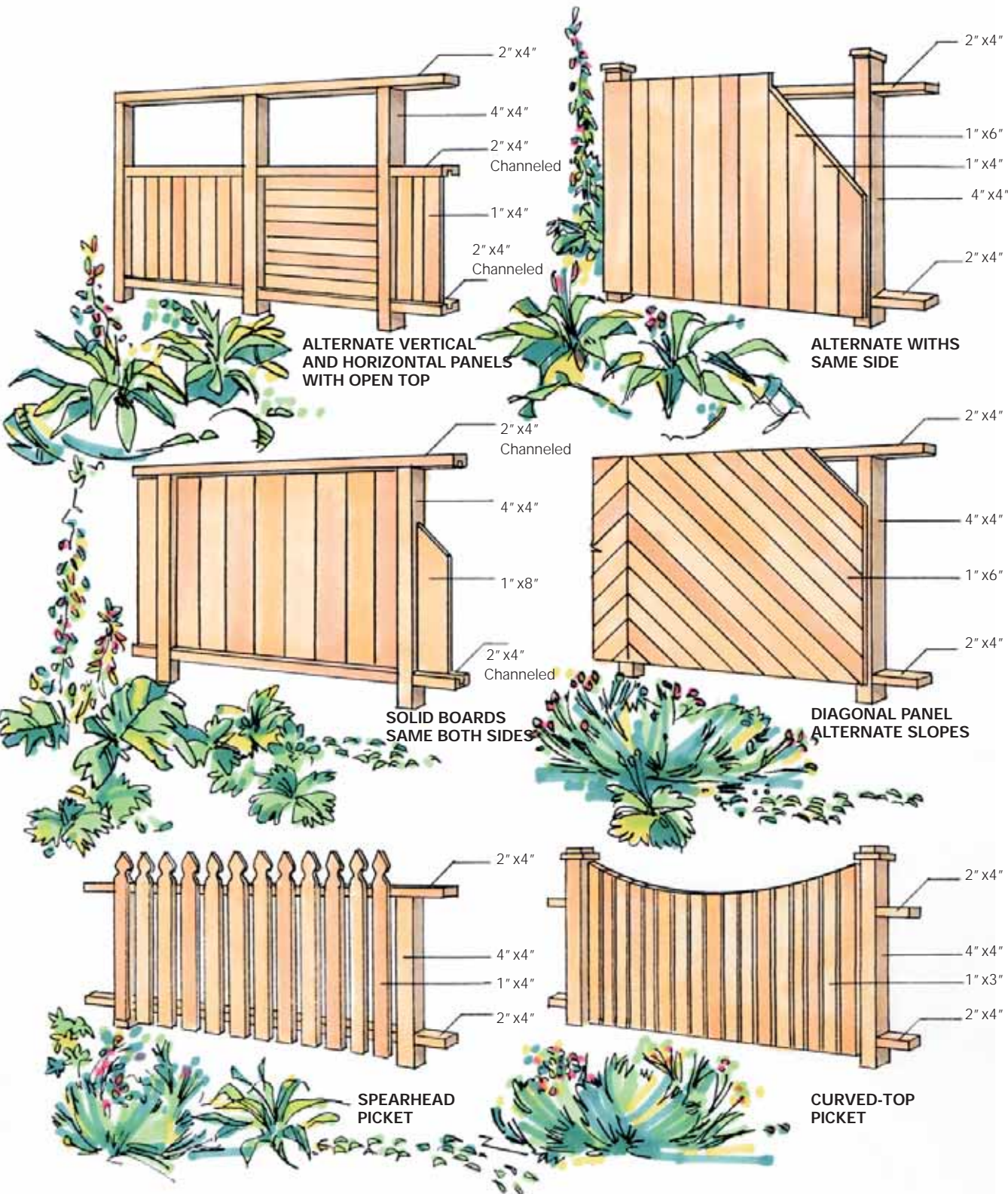

ALTERNATE VERTICAL AND HORIZONTAL PANELS WITH OPEN TOP

ALTERNATE WITHS SAME SIDE

SOLID BOARDS SAME BOTH SIDES

DIAGONAL PANEL ALTERNATE SLOPES

SPEARHEAD PICKET

CURVED-TOP PICKET

SOME TYPICAL BOARD AND PICKET FENCES

PRE-BUILT FENCE PANELS

Cedar fences of many styles are available in pre-built panels from 3 ft. to 6 ft. high. The boards may be plain, V-jointed tongue and groove, or channel patterns. Construction is usually 2x4 in. rails and 1x6 in. boards. Boards are usually butted tightly together but panels with spaced boards are also available. These time-saving fence sections are sold by the panel. You are advised to carefully examine fence panels to ensure that they are built from suitable quality cedar boards and are sturdily assembled with corrosion-resistant fasteners. When using pre-built fence panels it is important that you check the dimensions before installation. Good practice is to set posts and panels one at a time rather than pre-setting all posts.

LATTICE PANELS

Cedar lattice panels are an alternative or an addition to a solid cedar board fence. Rough or smooth-sawn lattice is available pre-built in a choice of square or diagonal patterns in modular sizes to match the most common pre-built fence panels and post spacings. A lattice fence offers less wind resistance than a solid fence and allows sunlight into shady garden areas. The degree of privacy is governed by the obscurity ratio of the Latticework.

Clear cedar lattice is one popular option but lattice manufactured from cedar with sound tight knots is both economical and good quality. Lattice made from 1x2 in. cedar is more sturdy and lasts longer than panels made from lath.

When purchasing lattice, you should make sure that it is well-manufactured from good quality cedar of adequate thickness and that it has been correctly assembled. Heavier lattice panels are usually assembled with staples only and require no perimeter framing. Thinner lath lattice may be assembled with exterior-type glue and/or with staples. Lath lattice should be framed around its perimeter. The better quality lath lattice is stapled such that the crown of the staple is flush or countersunk in the wood and the points of the staple do not penetrate the face of the panel.



The graceful curve of the top rail and latticework reduce the scale of this solid board fence.



A simple post and rail lattice fence. Finials on posts add a distinctive touch.

Some important points to remember when comparison-shopping for lattice panels are:

- Size of opening: a tighter weave provides greater privacy but is more costly because of the increased wood content.
- Thickness of lath: thicker is stronger and longer lasting but more expensive.
- Fasteners: corrosion-resistant fasteners greatly increase the service life of the fence panel and prevent unsightly rust streaks.
- Glue: exterior glue adds strength and rigidity to the panel. A simple post and rail lattice fence. Finials on posts add a distinctive touch.

SIZES OF WESTERN RED CEDAR FENCE POSTS

The most common sizes of fence posts are 4x4 in. and 6x6 in. either rough sawn or dressed (see below).

Nominal Size (inches)	Full Sawn Rough (inches)	Standard Swan Rough (inches)	Actual Dressed Size (inches)
4	4	3-3/4	3-9/16
6	6	5-3/4	5-9/16

SIZES OF WESTERN RED CEDAR FENCE RAILS

The most common sizes of cedar fence rails are 2x4 in. and 2x6 in. (See below).

Thickness (in.)			
Nominal	Full Sawn Rough	Standard Sawn Rough	Dressed S4S
2	2	1-3/4	1-9/16
Width (in.)			
Nominal	Full Sawn Rough	Standard Sawn Rough	Dressed S4S
4	4	3-3/4	3-9/16
6	6	5-3/4	3-9/16

SIZES OF WESTERN RED CEDAR FENCE BOARDS





Thickness (in.)			
Nominal	Full Sawn Rough	Standard Sawn Rough	Dressed S4S
1	5/8 11/16 23/32 3/4 13/16	11/16	23/32
5/4	1-1/16	1	1
Width (in.)			Length (ft)
Nominal	Rough	Dressed	
2	2	1-9/16	3
3	3	2-9/16	4
4	4	3-9/16	5
6	6	5-9/16	6
8	8	7-3/8	8
10	10	9-3/8	
12	12	11-3/8	

SPECIFICATION GUIDE FOR WESTERN RED CEDAR

The following information is an example of what is required when specifying Western Red Cedar fencing:

Specification Information Required	Sample Specification
Species: Western Red Cedar	WRCLA Western Red Cedar
Product Pattern: Specify the surface finish by choosing surfaced four sides (S4S), rough sawn or rougher headed.	Rough Sawn
Size: Specify the size of the product.	4x4 in. full sawn rough
Product Standard or Grade: The grade of the product governs its overall quality. Refer to WRCLA specification literature for available standards.	Architect Knotty
Grading Agency Paragraph: To ensure that the product meets a written standard, an agency grade paragraph or WRCLA product standard should be referenced.	WRCLA Product Standard
Quantity: Express as the number of posts/length in feet.	20/6 ft.

WESTERN RED CEDAR FENCING GRADES

Product Standard or Grade	Description	Standard Grading Rule Paragraph ¹								
<p>ARCHITECT CLEAR™</p> 	<p>Intended for applications where the finest appearance is desired. Posts are manufactured to a strict standard which restricts all natural characteristics that may detract from the fine appearance.</p>	WRCLA Product Standard								
<p>ARCHITECT KNOTTY®</p> 	<p>Specified when knotty posts of the best quality are desired. The standard requires sound and tight knots, prohibits wane and holes, and limits heart centers. Other characteristics are limited so as not to detract from the appearance.</p>	WRCLA Product Standard								
<p>CUSTOM KNOTTY®</p> 	<p>Combines good looks and budgetary value for the cost-conscious builder. The standard does not permit holes and limits heart centers. Wane and unsound knots are highly restricted.</p>	WRCLA Product Standard								
<p>STANDARD AND BETTER</p> 	<p>Commonly used for general fence construction where structural characteristics are more important than appearance. This grade permits a range of characteristics that meet the service requirements for fencing.</p>	<table border="1"> <thead> <tr> <th>4"</th> <th>6"</th> </tr> </thead> <tbody> <tr> <td>NLGA 122 b,c</td> <td>131 a,b,c</td> </tr> <tr> <td>WCLIB 122 b,c</td> <td>131 a,b,c</td> </tr> <tr> <td>WWPA 40.11.12</td> <td></td> </tr> </tbody> </table>	4"	6"	NLGA 122 b,c	131 a,b,c	WCLIB 122 b,c	131 a,b,c	WWPA 40.11.12	
4"	6"									
NLGA 122 b,c	131 a,b,c									
WCLIB 122 b,c	131 a,b,c									
WWPA 40.11.12										

¹NLGA – National Lumber Grades Authority
WCLIB – West Coast Lumber Inspection Bureau
WWPA – Western Wood Products Association



SURFACE TEXTURES

Western Red Cedar products may be specified in different surface finishes

Surfacing	Description	Available			
		Siding	Trim	Decking	Timbers
Rough	Rough sawn texture from either circular or band saws is present on all four sides.	Yes	Yes	No	Yes
Rougher Headed	The lumber receives its texture from a milling process which uses roughened planer knives. The rough texture is clearly visible on all four sides.	No	Yes	No	Yes
S1S2E	Surfaced One Side, Two Edges. This versatile product is the most popular choice for trim boards. The surfacing process resulting in a rough sawn face and a smooth back provides uniform width and thickness tolerances. Typically graded from the rough face.	No	Yes	No	No
S4S	Surfaced Four Sides. The smooth surface on all four sides presents a uniformly sized product with a quality appearance. This surface finish is most commonly found on Clear grades.	No	Yes	Yes	Yes
Smooth Face	Smooth surface on the face, butt and tip of siding. This surface finish is most commonly found on Clear grades.	Yes	No	No	No

FASTENERS

Hot-dipped galvanized, aluminum and stainless steel fasteners are all corrosion-resistant and can be used to fasten Western Red Cedar. Other types of nails are not recommended. They can rust and disintegrate and react adversely with the natural preservative oils present in cedar resulting in unsightly stains and streaks. Copper nails also react with cedar and should not be used. Stainless steel nails are the best choice, especially if trim boards are to be finished with transparent or semi-transparent stain. Use No. 304 stainless for general applications and No. 316 for seacoast exposures.

For best results use splitless fasteners designed for siding installation. This type of nail has a thin shank and blunt point and is available with a ring or spiral shank. Fastener length should be adequate to provide a minimum penetration of 1 1/4" into solid wood.

Large members require timber connectors other than nails. Bolts, lag screws, split rings and shear plates, and custom made hardware are commonly used in heavy timber structures where the joint's strength must be greater than that which could be achieved with nails. These types of connectors should be corrosion-resistant or suitably coated to prevent corrosion and staining. Generally, the design of mechanically fastened joints must take into consideration a variety of factors such as end- and edge-spacing distances, moisture content, service conditions, and the effect of the number of connectors used. Because the cost of fabricating and installing connections may amount to a large percentage of the cost of a heavy timber structure, it is important to engineer the details of a structure before designing the timber members.

Screws can be used to fasten decks. Double hot-dipped galvanized screws can be used, however, stainless steel screws are recommended. For most applications a 304 (18-8) grade provides adequate corrosion resistance. For decks exposed to salt air, use 316 grade. Screws must be long enough to penetrate 1". (25mm) into support members. Penetration of 1 1/4" is required for structural components.

Blind fastening systems create an attractive, fastener-free deck surface. They employ metal clips and/or joist top brackets that fasten the sides or bottom of the deck board to the joists so that no fasteners are visible. Blind fastening systems are the ideal complement to the beauty of Western Red Cedar decking.

FINISHING

Although cedar is naturally durable, a surface coat is recommended to protect the wood and extend its service life. Western Red Cedar accepts a wide range of stains and other coatings and-whichever is selected should be a good quality product recommended by a paint or building supply dealer. When selecting a finish coat, make sure it contains the following: Water repellent; Fungicide/mildewcide; Protection against ultra violet (UV) light.

Penetrating oil-based products, particularly those containing pigments, are recommended for Western Red Cedar. Pigments provide increased UV protection. Note that decks require products specifically formulated to withstand the abrasive effects of foot traffic. Use of varnishes or other types of film forming coatings are not recommended for cedar decks. These coatings can crack and peel and once applied are difficult to remove.

Before You Start:

- Never let Western Red Cedar weather for more than 2 weeks before staining or painting.
- Never use steel or any 'ferrous' metal tool or brush! Iron or steel will react with Western Red Cedar and cause staining.
- Never use a pressure washer on your Western Red Cedar

FINISH WESTERN RED CEDAR BEFORE IT IS INSTALLED

Although cedar is naturally durable, a surface coat is recommended to protect the wood and extend its service life. Western Red Cedar accepts a wide range of stains and other coatings and-whichever is selected should be a good quality product recommended by a paint or building supply dealer. When selecting a finish coat, make sure it contains the following: Water repellent; Fungicide/mildewcide; Protection against ultra violet (UV) light.

Semi-transparent stains can be used for decks, landscape structures, fences, siding and trim.

Solid stains and paint can be used for siding, trim, landscape structures and fences but never decks. Use an Alkyd Oil base and Stain Blocking Primer, not shellac

based. Top Coats should always be 100% Acrylic stain or paint.

TIP - New Cedar is best when purchased 'Machine Stained or Factory Primed' on all 6 sides of every piece.

TIP - Best surfaces to hold finish in order of preference: sanded with 50 to 80 grit; rough sawn; planed smooth.

TIP - Use a bush or a 'pad painter with bristles' If you spray on a coating, brush it in.

FINISHING INSTALLED WESTERN RED CEDAR

If you have already installed/built using unfinished Western Red Cedar clean the surface and finish as quickly as possible and before 2 weeks exposure to sunlight have elapsed.

TIP - Clean with Oxi-Clean or 'generic' equivalent solution. Use a soft brush and rinse using a Garden Hose.

For more detailed information on finishing, order the WRCLA's "Guide to Finishing" or visit the website www.wrcla.org



WESTERN RED CEDAR LUMBER ASSOCIATION

The Western Red Cedar Lumber Association is an organization of Western Red Cedar producers, distributors and retailers throughout North America. Founded in 1954, the association is known worldwide as “the voice of the cedar industry.” Its members account for more than 65 percent of the world’s production of cedar and have an annual volume of nearly 1 billion board feet.

The mission of the WRCLA is to promote quality Western Red Cedar products and support them with a comprehensive marketing and PR program, technical services, education and training. The WRCLA works closely with architects, designers and builders to ensure the right product is specified and utilized. The association offers extensive resources for builders and installers including installation guides and DVDs available in English, Spanish and Russian.

For more information about the WRCLA and Western Red Cedar siding products, visit our website www.wrcla.org or call 1 866 778 9096.

Assure yourself of quality Western Red Cedar products, always select materials originating from these WRCLA members:

MEMBERS

- Downie Timber
- Enyeart Cedar
- Gilbert Smith Forest Products
- Haida Forest Products
- Interfor
- Northwest Forest Products
- North Enderby Timber
- Orepac Building Products
- Premier Forest Products
- Pope & Talbot
- Power Wood Corp
- Quadra Wood Products
- Sawarne Lumber
- Shakertown
- Skana Forest Products
- TRI-PRO CEDAR Products
- Tyee Timber Products
- Welco Lumber USA
- Western Forest Products

AFFILIATE MANUFACTURERS

- B.W. CREATIVE WOOD
- CEDARSHED INDUSTRIES
- OUTDOOR LIVING TODAY
- RAINBOW PLAY SYSTEMS INC

AFFILIATE PARTNERS

- CABOT (PAINTS & STAINS)
- MAZE NAILS (FASTENERS)
- PPG MACHINE APPLIED COATINGS (PAINTS & STAINS)
- WEISS GROUP (FACTORY FINISHING)

For a list of distributors or affiliated retailers stocking WRCLA member product visit the Purchasing Cedar section of the WRCLA’s website.

Produced with the support of



NOTICE:

THE WESTERN RED CEDAR LUMBER ASSOCIATION (WRCLA) DOES NOT WARRANT THE ACCURACY OF THE INFORMATION HEREIN. THE WRCLA, ITS DIRECTORS, OFFICERS, EMPLOYEES, CONTRACTORS AND AGENTS SHALL NOT BE RESPONSIBLE OR LIABLE FOR ANY CAUSE OF ACTION, LOSS, DAMAGE, INJURY OR DEATH IN ANY WAY CONNECTED WITH THE INFORMATION HEREIN EVEN THOUGH SUCH CAUSE OF ACTION, LOSS, DAMAGE, INJURY OR DEATH ARISES FROM THE NEGLIGENCE OR DEFAULT OF THE WRCLA, ITS DIRECTORS, OFFICERS, EMPLOYEES, CONTRACTORS OR AGENTS. ALWAYS FOLLOW LOCAL AND NATIONAL BUILDING CODES.