



Instruction Manual

Econo 8 Popcorn Machine

Model No.: 2388, 2388-00-002







GOLD MEDAL® PRODUCTS CO.



10700 Medallion Drive, Cincinnati, Ohio 45241-4807 USA







SAFETY PRECAUTIONS

	 DANGER
	<p>Machine must be properly grounded to prevent electrical shock to personnel. Failure to do so could result in serious injury, or death. DO NOT immerse any part of this equipment in water. DO NOT use excessive water when cleaning. Keep cord and plug off the ground and away from moisture. Always unplug the equipment before cleaning or servicing. Make sure all machine switches are in the OFF position before plugging the equipment into the receptacle.</p> <p style="text-align: right; font-size: small;">008_051514</p>

	 DANGER
	<p>Improper installation, adjustment, alteration, service, or maintenance can cause property damage, injury, or death. Any alterations to this equipment will void the warranty and may cause a dangerous condition. This appliance is not intended to be operated by means of an external timer or separate remote-control system. NEVER make alterations to this equipment. Read the Installation, Operating, and Maintenance Instructions thoroughly before installing, servicing, or operating this equipment.</p> <p style="text-align: right; font-size: small;">014_020416</p>

	 WARNING
	<p>To avoid burns, DO NOT touch the kettle or any heated surface. DO NOT place or leave objects in contact with heated surfaces.</p> <p style="text-align: right; font-size: small;">013_092414</p>

	 WARNING
	<p>ALWAYS wear safety glasses when servicing this equipment.</p> <p style="text-align: right; font-size: small;">010_010914</p>

	 WARNING
	<p>No user serviceable parts inside. Refer servicing to qualified service personnel.</p> <p style="text-align: right; font-size: small;">011_051514</p>

	 WARNING
	<p>Read and understand operator's manual and all other safety instructions before using this equipment. To order copies of the operator's manual go to gmpopcorn.com or write to Gold Medal Products Co., 10700 Medallion Drive, Cincinnati, OH 45241 USA 1-(800)-543-0862</p> <p style="text-align: right; font-size: small;">022_060215</p>



SAFETY PRECAUTIONS (continued)

	⚠ WARNING
	<p>DO NOT allow direct contact of this equipment by the public when used in food service locations. Only personnel trained and experienced in the equipment operation may operate this equipment. Carefully read all instructions before operation.</p> <p style="text-align: right;">012_010914</p>

	⚠ WARNING
	<p>This machine is NOT to be operated by minors.</p> <p style="text-align: right;">007_010914</p>

Note: Improvements are always being made to Gold Medal's equipment. This information may not be the latest available for your purposes. It is critical that you call Gold Medal's Technical Service Department at 1-800-543-0862 for any questions about your machine operations, replacement parts, or any service questions. (Gold Medal Products Co. does not assume any liability for injury due to careless handling and/or reckless operation of this equipment.) General images may be used in manual for reference only.



INSTALLATION INSTRUCTIONS

Inspection of Shipment

After unpacking, check thoroughly for any damage which may have occurred in transit. Claims should be filed immediately with the transportation company. The warranty does not cover damage that occurs in transit, or damage caused by abuse, or consequential damage due to the operation of this machine, since it is beyond our control (reference warranty in back of manual).

Manual

Read and understand the operator's manual and all other safety instructions before using this equipment. To order copies of the operator's manual go to gmpopcorn.com or write to Gold Medal Products Co., 10700 Medallion Drive, Cincinnati, OH 45241 USA 1-(800)-543-0862.

Model Description

2388: Econo 8 oz. Popper.

2388-00-002: Econo 8 oz. Popper unit equipped with a PowerOff™ Control feature.

Items Included with this Unit

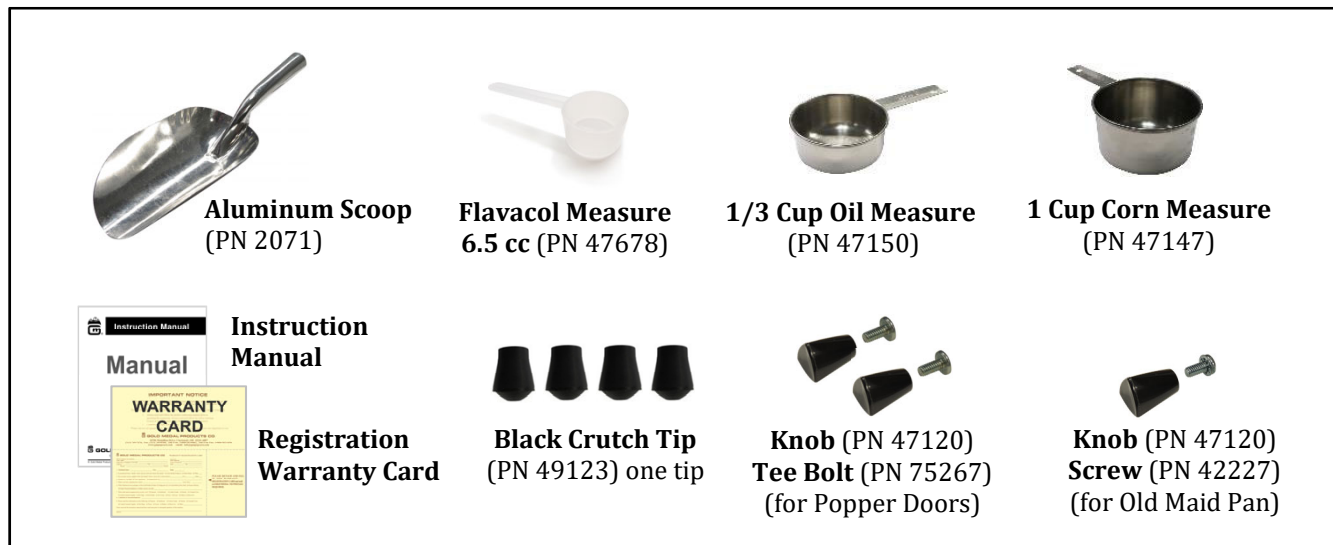

Setup

This unit has been tested at the factory.



1. Remove all packaging and tape prior to operation. Remove accessories and carefully remove kettle packed in cabinet interior.
2. Place unit on a sturdy, level base.
3. Unit has 4 glide feet preinstalled at the factory (see image below). Install a Black Crutch Tip on each foot. Firmly push crutch tip over glide until it covers glide entirely.
4. Tilt kettle and insert into hanger arms, then allow kettle to return naturally to an upright position (see image below).
5. Plug kettle lead into receptacle located on ceiling of cabinet interior. Align keyed or hook shaped prong with the correct opening, then push plug all the way in and twist or rotate to lock in place. To unplug, untwist kettle plug before attempting to pull from receptacle.
6. Door knobs are shipped in accessories pack. Install a door knob with tee bolt on each popper door; install knob with screw on old maid pan.
7. After setup, unit should be cleaned prior to use (see Care and Cleaning section).



Electrical Requirements

The following power supply must be provided:



2388, 2388-00-002: 120 V~, 1525 W, 60 Hz

	 DANGER
	<p>Machine must be properly grounded to prevent electrical shock to personnel. Failure to do so could result in serious injury, or death. DO NOT immerse any part of this equipment in water. DO NOT use excessive water when cleaning. Keep cord and plug off the ground and away from moisture. Always unplug the equipment before cleaning or servicing. Make sure all machine switches are in the OFF position before plugging the equipment into the receptacle.</p> <p style="text-align: right; font-size: small;">008_051514</p>

A certified electrician must furnish sufficient power for proper machine operation and install any supplied receptacle. We recommend this equipment be on a dedicated and protected circuit. Failure to wire properly will void the warranty and may result in damage to the machine. It is Gold Medal Products Co.'s recommendation that this machine be plugged directly into a wall outlet. The use of extension cords is not recommended due to safety concerns, and may cause sacrificed and/or reduced performance. Make sure cord is located to prevent a trip hazard or unit upset.

Before You Plug In Machine

1. Make sure all machine switches are OFF before plugging equipment into receptacle.
2. Make sure wall outlet can accept the grounded plugs (where applicable) on the power supply cord.
3. The wall outlet must have the proper polarity. If in doubt, have a competent electrician inspect the outlet and correct if necessary.
4. **DO NOT** use a grounded to un-grounded receptacle adapter (where applicable).
5. Install unit in a level position.

	 CAUTION
	<p>If the supply cord is damaged, it must be replaced by Gold Medal Products Co., its service agent or similarly qualified persons in order to avoid a hazard.</p> <p style="text-align: right; font-size: small;">039_080614</p>



OPERATING INSTRUCTIONS

Controls and Their Functions

KETTLE HEAT SWITCH

Two position, ON/OFF lighted rocker switch - supplies power to the heating element in the kettle. The green switch light ON indicates there is power to the kettle heating element.

KETTLE MOTOR SWITCH

Two position, ON/OFF lighted rocker switch - supplies power to the kettle agitator motor. The Kettle Motor Switch **MUST** be ON at all times when there is popcorn (popped or un-popped) in the kettle.

LIGHTS/WARMER SWITCH

Two position, ON/OFF lighted rocker switch - supplies power to the interior cabinet light and corn pan heat element.

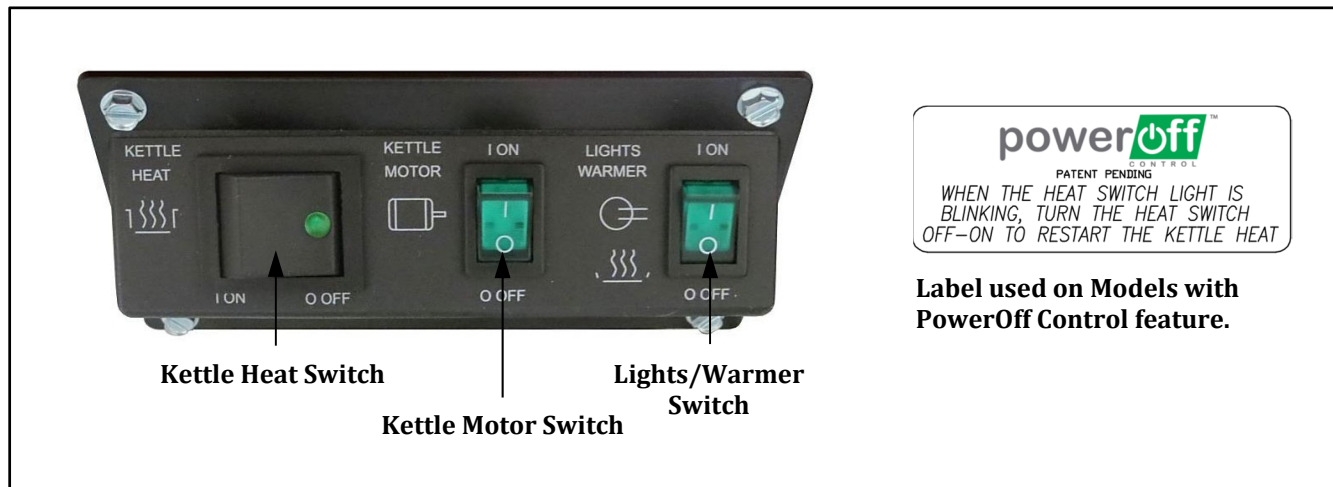

POWEROFF CONTROL (Model 2388-00-002 only)

The PowerOff Control feature will automatically turn the kettle heat off after 15 minutes of idle time (no popcorn popped). The PowerOff Control will prevent the heat element and thermostat from cycling OFF-ON if the Kettle Heat Switch is left on. This feature saves electrical power and extends the life of the kettle heating element and thermostat.

- When the Kettle Heat Switch is turned ON, and the kettle thermostat switches OFF, the PowerOff Control's 15 minute timer starts; the 15 minute timer resets each time a batch of popcorn is popped.
- The small green neon light in the Kettle Heat Switch will blink OFF-ON to indicate the kettle has been automatically turned OFF.
- To restart the kettle heating, cycle the Kettle Heat Switch OFF-ON.



Popping Corn Instructions

This section describes instructions for popping Salted Popcorn.

The popper is equipped with a corn, salt, and oil measure. We recommend flavored and colored coconut oil. Popcorn popped in coconut oil stays fresh longer and does not leave black deposits in the kettle like other oils. Use only top quality, fresh popcorn from reputable suppliers.

Popping Salted (Standard) Popcorn

Raw Popcorn Charge:	Use corn measure provided (ex: for 6 oz. Kettle, use 6 oz. corn)
Recommended Oil Volume:	Oil volume is approx. 30% of corn amount (ex: for 6 oz. corn, use 2 oz. oil)
Flavacol (Salt) Amount:	Use small Flavacol scoop provided

Premeasure all ingredients (adjust as needed for desired taste), or for best results use Mega-Pop® premeasured popcorn and oil pouch made for your kettle size.

1. Turn all switches ON.
2. To determine when kettle is ready to pop corn (about 4 minutes), test pop three kernels of corn in one ounce (30 ml) of popping oil. When kernels pop, kettle is ready.
3. Lift kettle lid, pour in popcorn and Flavacol, then add oil; close lid.
4. When corn has finished popping, gently dump the popcorn.

Popping Tip: On final batch, turn Kettle Heat Switch OFF just as lids are forced open by the popping corn (kettle has plenty of heat to finish popping). This helps eliminate smoke/odor from any oil residue remaining in kettle.

5. When finished popping, turn KETTLE HEAT and KETTLE MOTOR switches OFF.
NEVER LEAVE THE HEAT ON WHEN YOU ARE NOT POPPING CORN!

Units with an auto kettle heat shut off feature will automatically shut kettle heat OFF after 15 min. of idle time (no popcorn popped). To restart heating, cycle the Heat Switch OFF-ON.

Care and Cleaning

	⚠ DANGER
	<p>Machine must be properly grounded to prevent electrical shock to personnel. DO NOT immerse in water. DO NOT clean appliance with a water jet. Always unplug the equipment before cleaning or servicing.</p> <p style="text-align: right;">025_111616</p>

	⚠ WARNING
	<p>To avoid serious burns, DO NOT touch the kettle while it is hot!</p> <p style="text-align: right;">028_082715</p>

Good sanitation practice demands that all food preparation equipment be cleaned regularly (only use non-toxic, food grade cleaners). A clean looking, well-kept machine is one of the best ways of advertising your product.

Note: It is extremely important to follow all of the cleaning procedures, otherwise parts damage and equipment failure will result. The warranty does not cover parts that are damaged due to improper cleaning.

Daily Kettle Cleaning Instructions

CAUTION: A hot kettle will cause burns if you touch it with your hand. Allow kettle to cool at least 1 hour before attempting to clean. **DO NOT** use ice or water to cool down a hot kettle! Severe kettle damage will result!

1. When cool, wipe the **outside** of the kettle with a clean, soft cloth. **DO NOT** use oven cleaners or abrasive materials as they will damage the kettle.
2. Every night, mix Gold Medal's Heat'n Kleen solution (Item No. 2095), 2 tablespoons per gallon of water. It is not necessary to use the entire gallon at once; only use enough to fill the kettle 1/2 inch deep.
3. Turn the kettle heat ON. When the water starts to boil, turn the kettle heat OFF.
4. Allow to cool for at least 1 hour, then dump the solution into a bucket and wipe the inside of the kettle with a clean cloth. Make sure all of the solution goes into the bucket; do not spill any in the interior of the machine.

For extra dirty kettles, the process may be repeated; or, after turning the kettle heat OFF, allow solution to sit in the kettle overnight. The next morning, dump the solution into a bucket and wipe the inside of the kettle with a clean cloth.

5. With the unit OFF and unplugged, wipe the kettle lead cord with a clean SLIGHTLY damp cloth. **DO NOT get moisture into the kettle lead-in cord, severe damage will result.**



Daily Unit Cleaning Instructions

1. With the machine OFF, unplug the unit and allow it to cool before attempting to clean.
2. Make sure to clean all pans/accessories in order to sanitize them before each use.
3. Take a clean, SLIGHTLY damp cloth and wipe excess grease from the glass and cabinet.
4. Wipe the stainless steel parts with a clean cloth and cleaner designed for stainless steel, such as Gold Medal Watchdog Stainless Cleaner (Item No. 2088).

DO NOT use oven cleaners or abrasive materials as they will damage parts of the machine.

5. Clean the glass panels with glass cleaner. Gold Medal Watchdog Glass Cleaner (Item No. 2588) is recommended.

Ammonia cleaners will damage the plastic doors. Use only non-ammonia cleaners, such as Gold Medal Watchdog Glass Cleaner (Item No. 2588).



Troubleshooting

Issue	Possible Cause	Solution
No Power to the Unit	A. No Power to the Unit	A. Make sure the unit's power cord is plugged in.
Kettle Does Not Heat	A. Power to the Kettle B. Kettle Heat Switch C. PowerOff Control D. Heating Element	A. Make sure kettle lead-in cord is plugged in and twisted to lock into the kettle receptacle. B. Have a qualified service person check the voltage to and from the Kettle Heat Switch; if switch is defective, replace it. C. Units with the PowerOff Control feature, kettle heat will automatically shut OFF after 15 minutes of idle time (no popcorn popped). The small green neon light in the Kettle Heat Switch will blink OFF-ON to indicate the kettle has been automatically turned OFF. To restart kettle heating, cycle the Heat Switch OFF-ON. Reference the Controls and Their Functions section of this manual. D. Heating element in the kettle may be burned out. Check with a qualified service person for inspection/repair.
Long Popping Cycles (Longer than 4 minutes for Salt Popcorn)	A. Low Voltage B. Inadequate Supply Lines C. Inferior Corn	A. If the machine is operated on low voltage, this could cause the kettle not to reach the proper operating temperature. Check with a qualified electrician. B. Inadequately sized electrical supply lines or use of extension cord, in addition to being a fire hazard, would also prevent the kettle from reaching the proper operating temperature. Check with a qualified electrician. C. Inferior quality corn would result in longer popping cycles. Use only top quality hybrid popcorn from reputable suppliers. Even then, if you let your corn pick up moisture or dry out, your popping cycles will be slow.
Kettle Agitator Shaft not Rotating If the kettle agitator shaft is not rotating, DO NOT pop corn.	A. Kettle Motor Switch B. Kettle Agitator Shaft/Stir Blade not rotating. (Unit must be OFF, unplugged and cool prior to checking or adjusting the agitator assembly.)	A. Make sure the Kettle Motor Switch is ON. If the switch is ON, and the shaft is not rotating, the switch or motor may be faulty, contact qualified service personnel for inspection/repair. B. Kettles with a FLOATING Stir Rod – lift the agitator weight and check the clearance between the shaft and the kettle bottom; it should be a minimum of 1/32" (thickness of a dime). To make shaft adjustments, reference the Agitator Set Collar Adjustment section.

Agitator Set Collar Adjustment

The following instructions describe how to properly adjust set collars on an agitator assembly with a floating stir rod.

Agitator Assembly with a FLOATING Stir Rod

Steps to Adjust Set Collars

Step 1: Turn machine OFF, unplug unit, and allow it to cool completely before attempting to adjust the agitator height.

Step 2: Loosen the set screw in each set collar to be adjusted.

Step 3: With the kettle mounted in the popper, adjust the shaft so the Spur Gears are halfway engaged, and the Needle Bearing is at least halfway engaged in the gear block (reference image at right).

DO NOT set spur gears at full gear contact; it can cause binding as the kettle is dumped.

Step 4: Snug tighten only, the set screw in set collar above the crossbar to hold position. Then, lift the agitator weight and check the clearance between the shaft and the kettle bottom. If there is adequate clearance, fully tighten the set screw to secure set collar in place.

Step 5: Adjust clearance between the bottom of the crossbar and the lower set collar to 1/32" (thickness of a dime); then re-tighten set screw to secure in place (reference image).

Step 6: Adjust set collar for agitator weight to be between 3/16" to 1/4" above the agitator weight. Once adjusted, re-tighten set screw to secure in place.

Agitator shown for general image reference only (lids not shown for clarity).

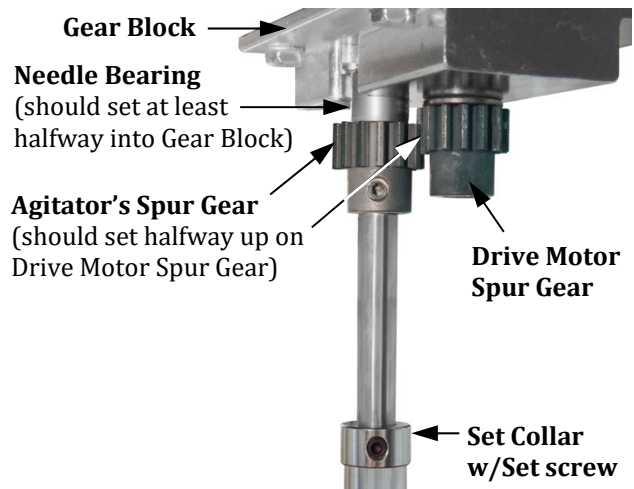



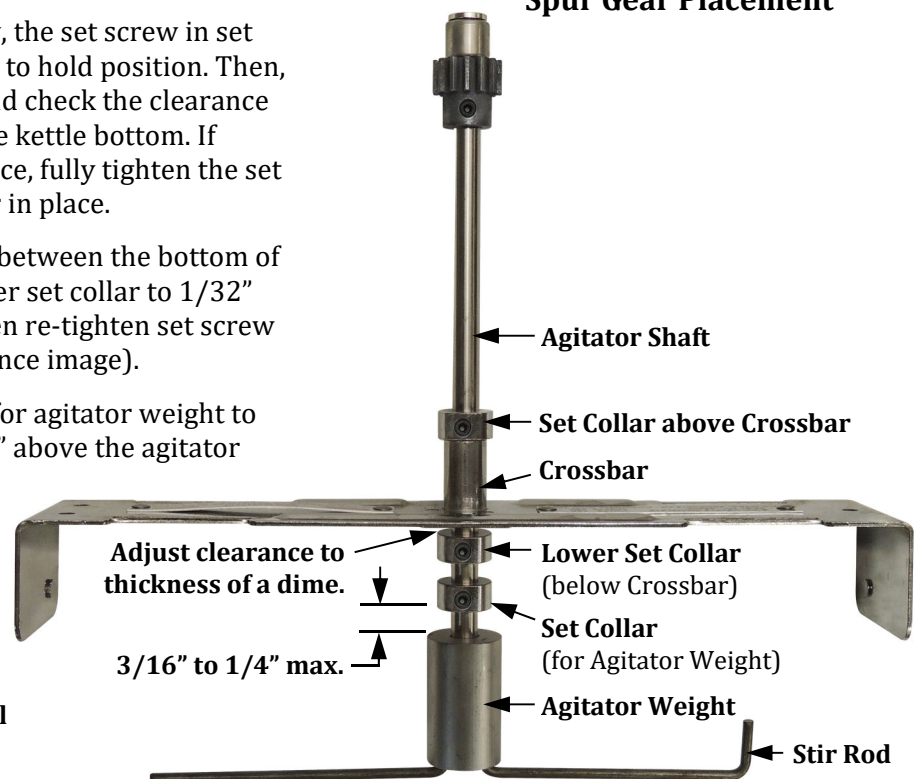

Spur Gear Placement







MAINTENANCE INSTRUCTIONS

	 DANGER
	<p>Machine must be properly grounded to prevent electrical shock to personnel. Failure to do so could result in serious injury, or death. DO NOT immerse any part of this equipment in water. DO NOT use excessive water when cleaning. Keep cord and plug off the ground and away from moisture. Always unplug the equipment before cleaning or servicing. Make sure all machine switches are in the OFF position before plugging the equipment into the receptacle.</p> <p style="text-align: right; font-size: small;">008_051514</p>

	 DANGER
	<p>Improper installation, adjustment, alteration, service, or maintenance can cause property damage, injury, or death. Any alterations to this equipment will void the warranty and may cause a dangerous condition. This appliance is not intended to be operated by means of an external timer or separate remote-control system. NEVER make alterations to this equipment. Read the Installation, Operating, and Maintenance Instructions thoroughly before installing, servicing, or operating this equipment.</p> <p style="text-align: right; font-size: small;">014_020416</p>

	 WARNING
	<p>No user serviceable parts inside. Refer servicing to qualified service personnel.</p> <p style="text-align: right; font-size: small;">011_051514</p>

	 CAUTION
	<p>THE FOLLOWING SECTIONS OF THIS MANUAL ARE INTENDED ONLY FOR QUALIFIED SERVICE PERSONNEL WHO ARE FAMILIAR WITH ELECTRICAL EQUIPMENT. THESE ARE NOT INTENDED FOR THE OPERATOR.</p> <p style="text-align: right; font-size: small;">027_010914</p>



ORDERING SPARE PARTS

1. Identify the needed part by checking it against the photos, illustrations, and/or parts list. (General images may be used in manual for reference only.)
2. Use only approved replacement parts when servicing this unit.
3. When ordering, please include part number, part name, and quantity needed.
4. Please include your model number, serial number, and date of manufacture (located on the machine nameplate/data plate) with your order.
5. Address all parts orders to:

Parts Department
Gold Medal Products Co.
10700 Medallion Drive
Cincinnati, Ohio 45241-4807

Or, place orders by phone or online:

Phone: (800) 543-0862
(513) 769-7676
Fax: (800) 542-1496
(513) 769-8500
E-mail: info@gmpopcorn.com
Web Page: gmpopcorn.com



Replacing Broken Glass

Broken glass panels can be easily replaced. Gold Medal Products Co. does not ship glass. It can be obtained from a local glass shop, always purchase tempered glass.

GLASS DIMENSIONS (Height x Width x Thickness)

Front Glass: 22 3/8" X 16 15/16" X 1/8" (1 Piece)

Side Glass: 22 3/8" X 14 15/16" X 1/8" (2 Pieces)

1. Turn machine OFF, unplug unit and allow it to cool before attempting to replace glass.
2. Remove all loose pieces of glass (popper units: kettle may be removed to change glass).
3. Place a bungee (or large rubber band) around the unit to help hold the corner posts in place, then remove dome.
4. Remove all rigid glass channels from around glass to be replaced, set channels aside for reuse.

Note: The rigid channels may be wedged in the corner posts or top and bottom glass extrusions, and must be removed before new glass can be installed.

5. Carefully remove the rest of the broken glass.
6. Apply decals (if desired) to new glass panel.
7. Slide rigid glass channels over exposed sides and bottom of new glass panel.
8. Lift motor plate just enough to allow the new glass panel to slide into the corner posts and down into the bottom glass extrusion.
9. Carefully lower the motor plate until the top glass extrusion secures glass in place.
10. Reinstall dome, and remove bungee (popper units: reinstall kettle if removed).



8 oz. Kettle Assembly (49472N) – Agitator Assembly View

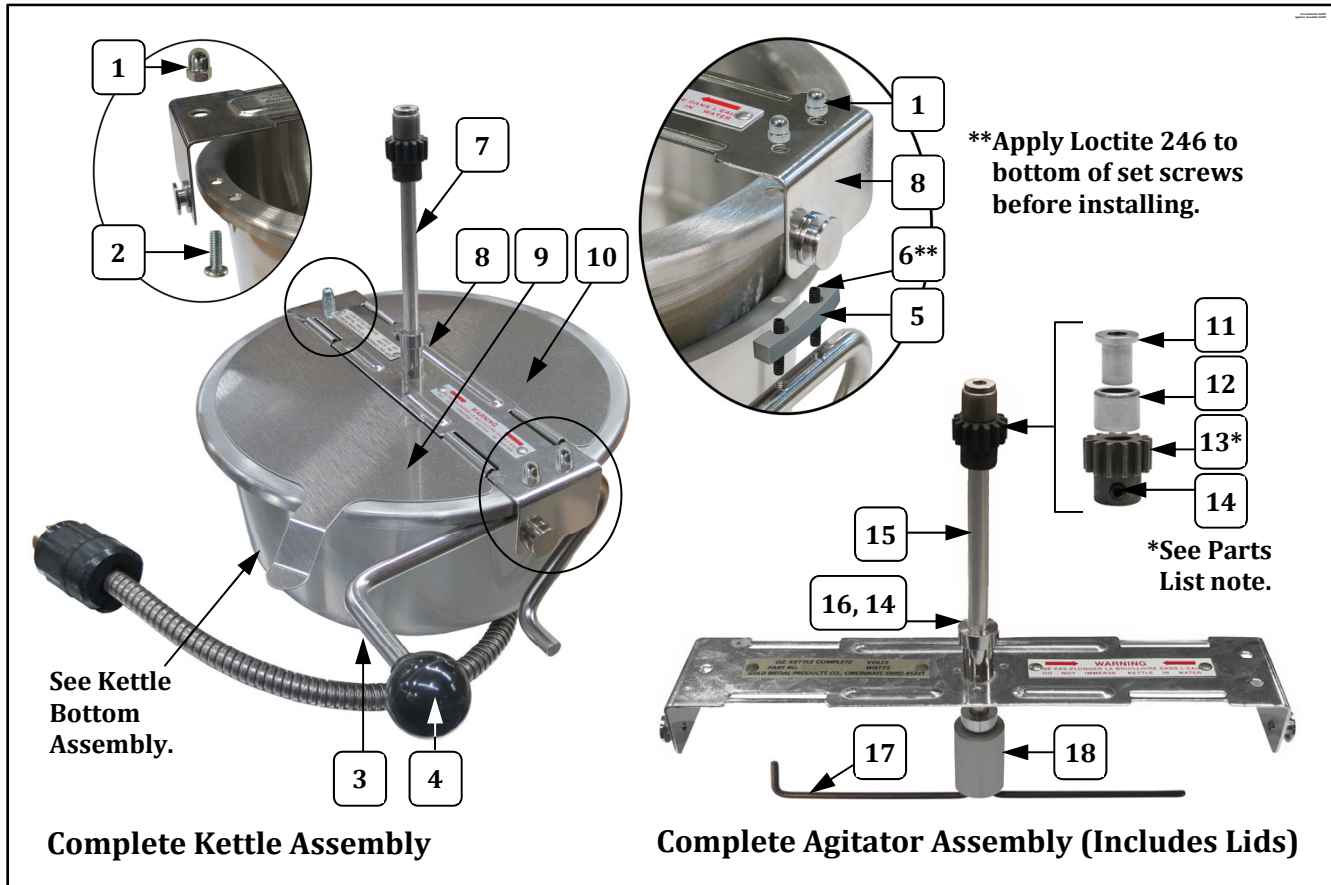

Item	Part Description	Part Number
		49472N
1	ACORN NUT	47702
2	8-32 X 1/2 PHIL PAN M/S	47141
3	DUMP HANDLE RH	49314
4	DUMP HANDLE KNOB	47110
5	SPACER (For Dump Handle)	49362
6	8-32 X 1" SET SCREW	77933
7	LID & AGITATOR ASSY (Complete Assembly)	49906N
8	KETTLE CROSSBAR ASSEMBLY	49907N
9	FRONT LID W/FORMED LIFTER	49017
10	REAR KETTLE LID	49016
11	AGITATOR BEARING HUB	43434
12	NEEDLE BEARING	47106
13*	SPUR GEAR KIT (Includes 2 gears with set screws. Always replace Agitator Spur Gear and Kettle Drive Motor Gear as a set.)	47059K
14	SET SCREW #10-32 X 3/16	41742
15	6 OZ. AGITATOR SHAFT	69710
16	SET COLLAR 5/16 ID 5/8 OD	46649
17	6 OZ. STIR ROD	69714
18	AGITATOR WEIGHT	69715



8 oz. Kettle Assembly (49472N) – Kettle Bottom Assembly

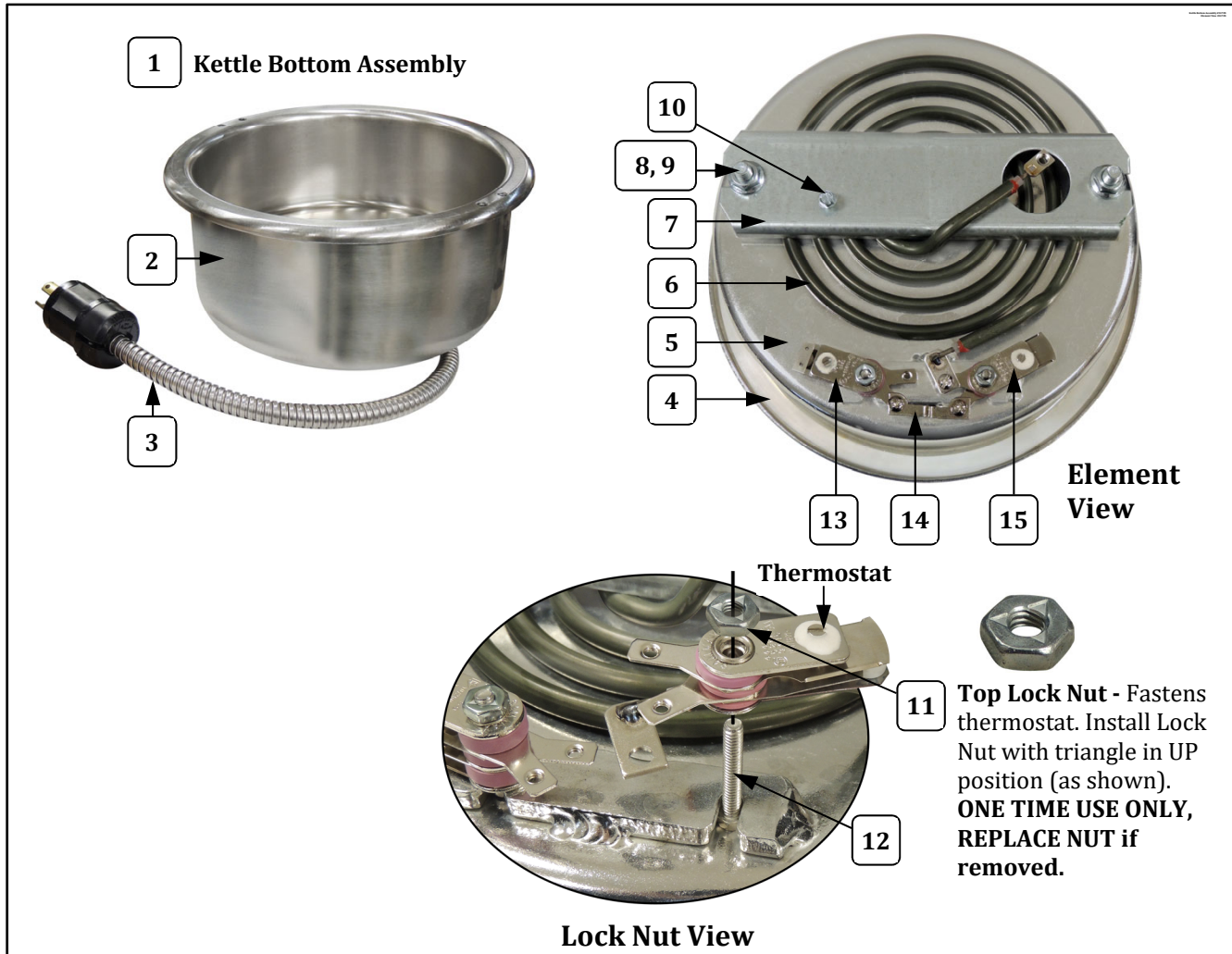

Item	Part Description	Part Number
		49472N
1	8 OZ. KETTLE BOTTOM ASSEMBLY (Complete Assembly - includes parts listed below)	49489N
2	KETTLE SHELL	49431
3	KETTLE LEAD ASSEMBLY	49328
4	6 OZ. KETTLE GASKET	49368
5	6 OZ. CLAD KETTLE	49596
6	HEAT ELEMENT 120V, 1125W	49529
7	ELEMENT CLAMP	49532
8	5/16-18 SERRATED LOCK NUT	49317
9	5/16-18 X 3/4 SQUARE HEAD BOLT	49446
10	8-32 X 1/4 SLT. HWH M/S (fastens ground)	49060
11	8-32 TOP LOCK NUT (always replace if removed)	67943
12	8-32 x 1 SS HEX SC (holds Thermostat)	49076
13	450°F THERMOSTAT (includes two 6-32 Screws)	76089
14	THERMOSTAT SHUNT BAR	47193
15	525°F THERMOSTAT (includes two 6-32 Screws)	76702



Cabinet Exterior – Front View

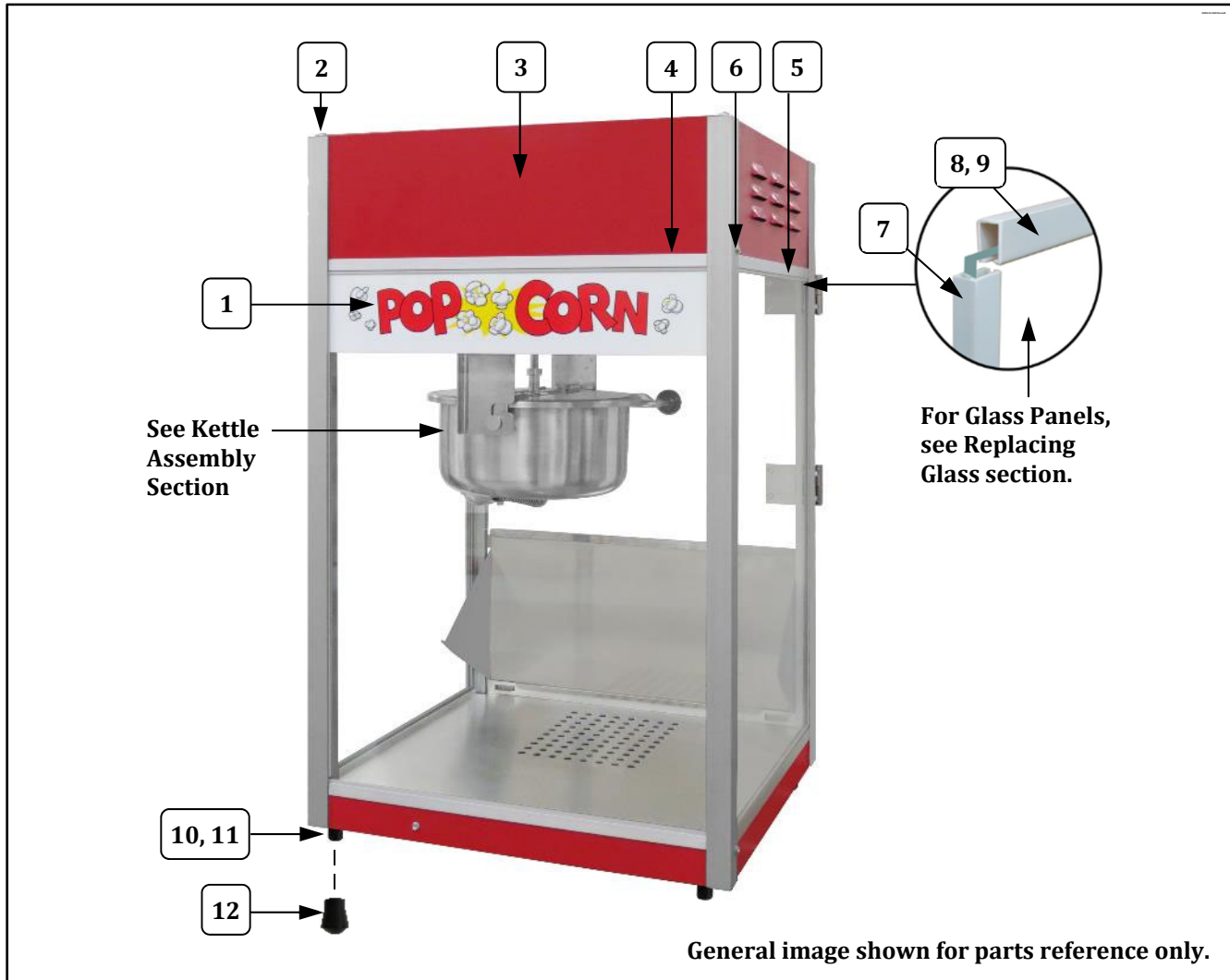

Item	Part Description	Part Number
		All Models
1	FRONT GLASS DECAL	49158
2	8-32" X 5/8" TYPE 23 HX HD	49052
3	TOP PAN	49452
4	GLASS EXTRUSION (Front Glass)	74164
5	GLASS EXTRUSION (Side glass)	49508
6	8-32 x 5/16 SLOTTED HEX	49594
7	21 5/8" GLASS CHANNEL (used on sides of glass panels)	49509
8	15" GLASS CHANNEL (used on top and bottom of side glass panels)	49510
9	17" GLASS CHANNEL (used on top and bottom of front glass panel)	49511
10	GLIDE FOOT (2 required)	47328
11	10-24 X 3/4 HEX HD	41314
12	BLACK CRUTCH TIP	49123



Cabinet Exterior – Rear View

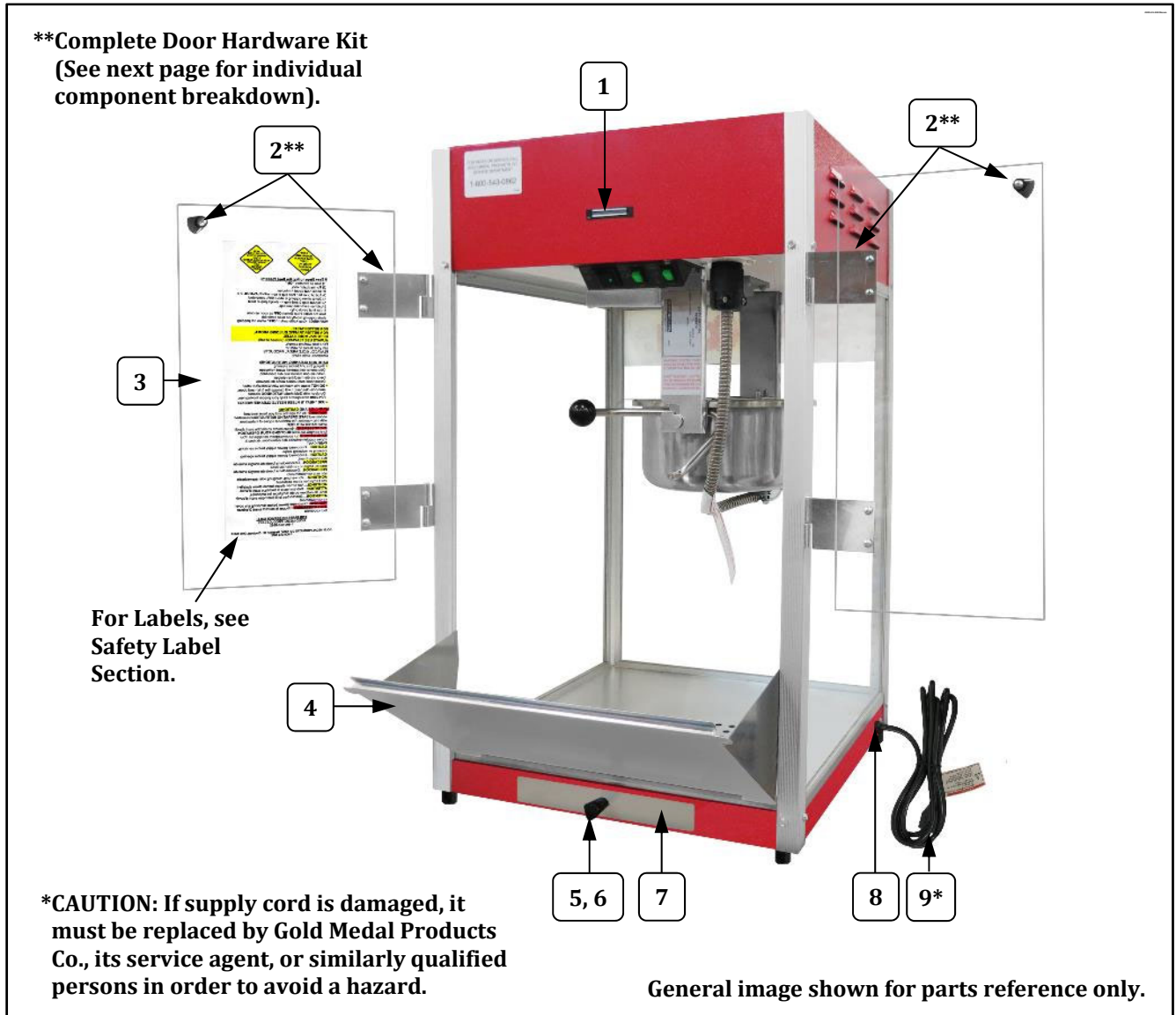

Item	Part Description	Part Number
		All Models
1	MAGNETIC CATCH	47561
2**	COMPLETE DOOR HARDWARE KIT	61380
3	PLEXIGLASS DOOR	49395
4	DROP PANEL	49145
5	KNOB LID LIFT	47120
6	8-32" X 3/8" PH PAN W/SEMS	42227
7	OLD MAID PAN	49100
8	#SR-6P3-4 STRAIN RELIEF	76026
9*	POWER SUPPLY CORD 15 AMP	22038



Door Hardware Kit 61380 – Individual Component Breakdown

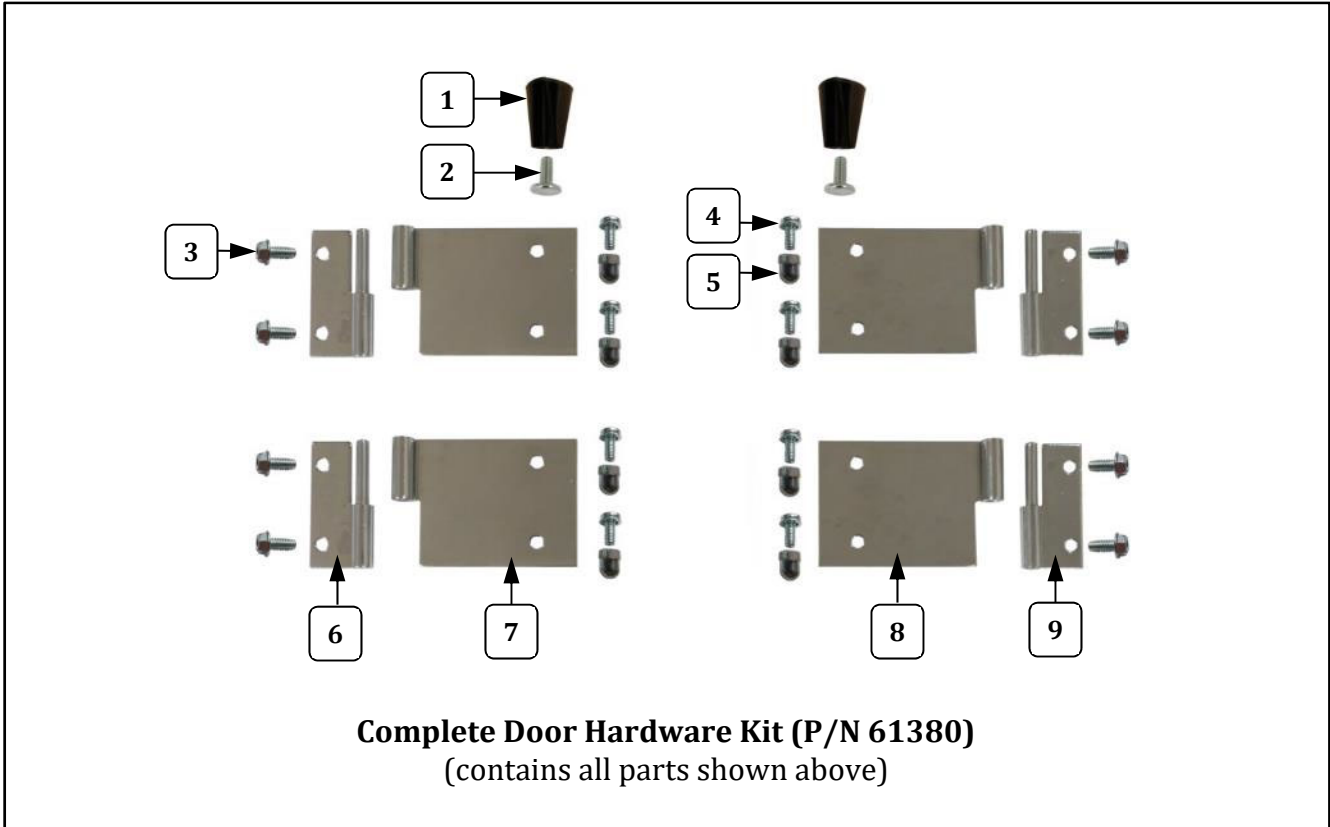

Item	Part Description	Part Number
		61380
1	KNOB LID LIFT	47120
2	TEE BOLT	75267
3	8-32 X 5/16 SLOTTED HEX	49594
4	8-32 X 3/8 PH PAN W/SEMS	42227
5	ACORN NUT #8-32	47702
6	MALE HINGE SHORT LEFT	41349
7	FEMALE HINGE LEFT HAND	61359
8	FEMALE HINGE RIGHT HAND	61373
9	MALE HINGE SHORT RIGHT	41350



Cabinet Interior – Hanger Assembly

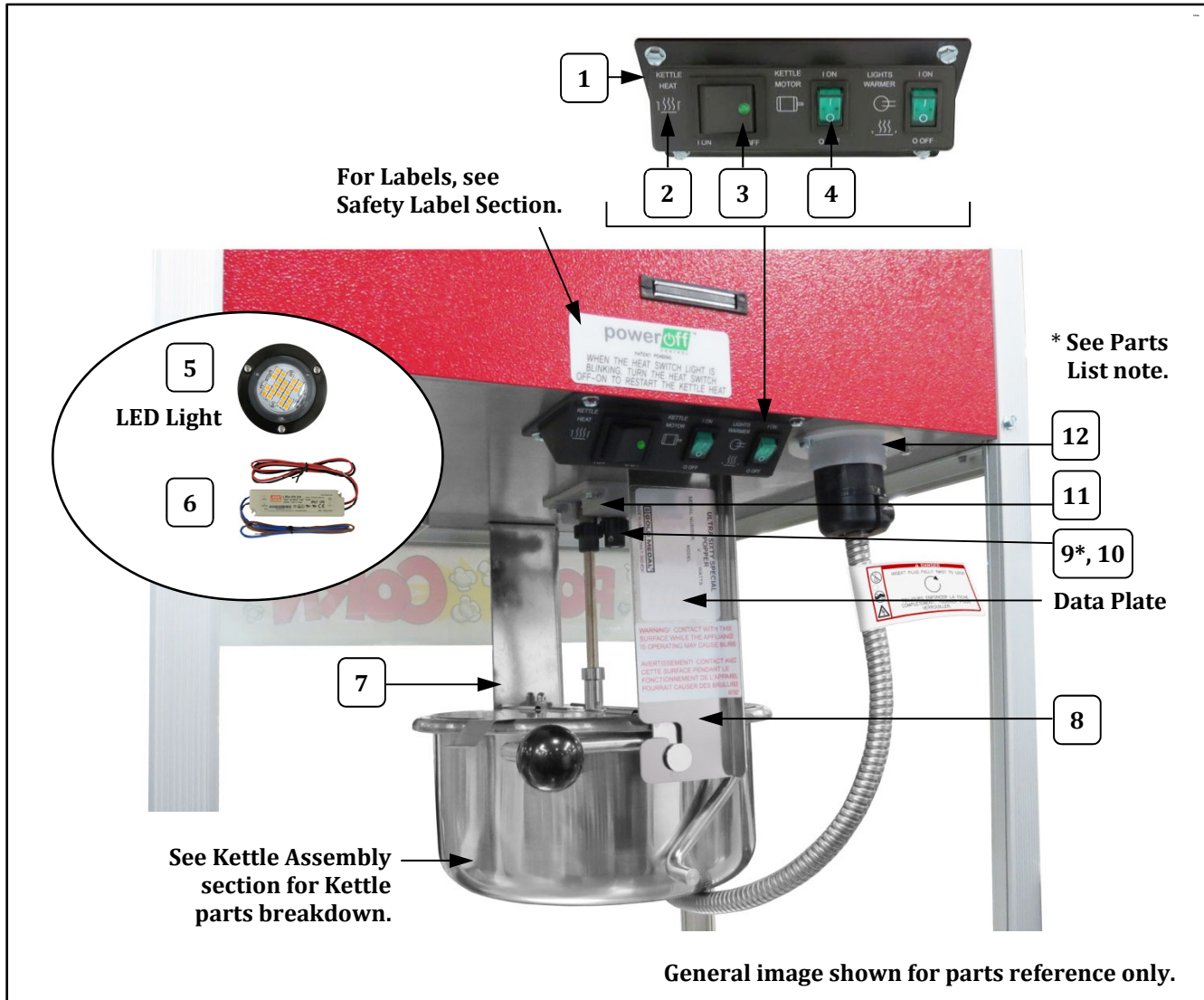

Item	Part Description	Part Number
		All Models
1	SMALL SWITCH BOX	48501
2	SWITCH BOX LABEL	48502
3	GREEN LIGHTED ROCKER SWITCH	42798
4	DPST ROCKER SWITCH	42532
5	LED REPLACEMENT NO PLATE	100544
6	POWER SUPPLY 24VDC 20W	55394
7	REAR HANGER ARM	49009
8	FRONT HANGER ARM	49010
9	SPUR GEAR KIT (Includes 2 gears with set screws. Always replace Agitator Spur Gear and Kettle Drive Motor Gear as a set.)	47059K
10	10-32" X 3/16" SET SCREW	41742
11	GEAR BLOCK ASSEMBLY	67194
12	15 AMP TWIST LOCK KETTLE RECPT	49330



Cabinet Interior – Corn Pan/Element View

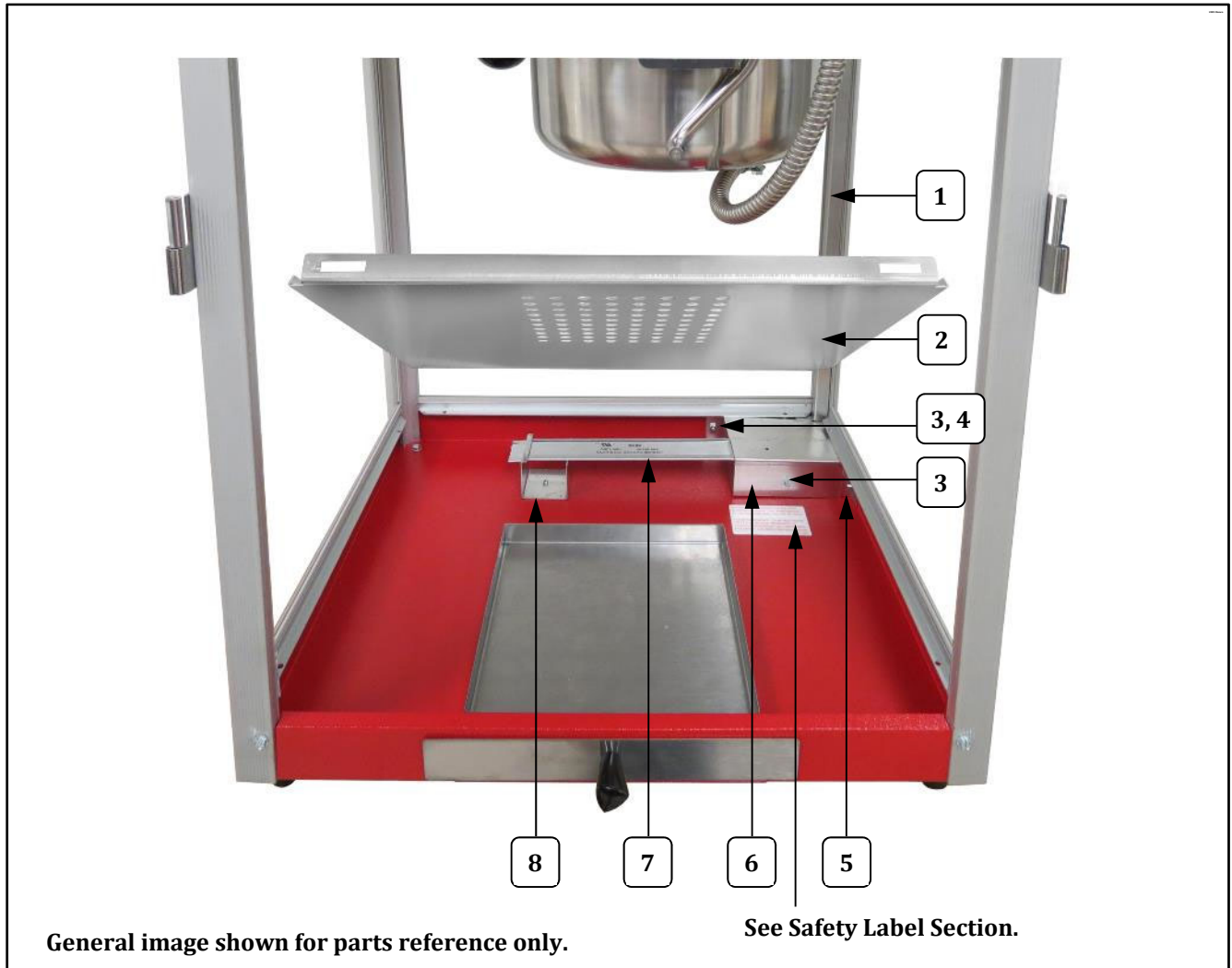

Item	Part Description	Part Number
		All Models
1	WIRE DUCT (runs the entire length of the corner post)	49091
2	BOTTOM CORN PAN	49506
3	8-32 X 3/8 SLT. HWH M/S	42044
4	8-32 HEX M/S NUT	74149
5	CORNER COVER	49105
6	CORNER COVER - COVER	49104
7	STRIP HEAT ELEMENT 50W	49440
8	STRIP HEATER BRACKET	49425



Dome Interior – Electrical Components

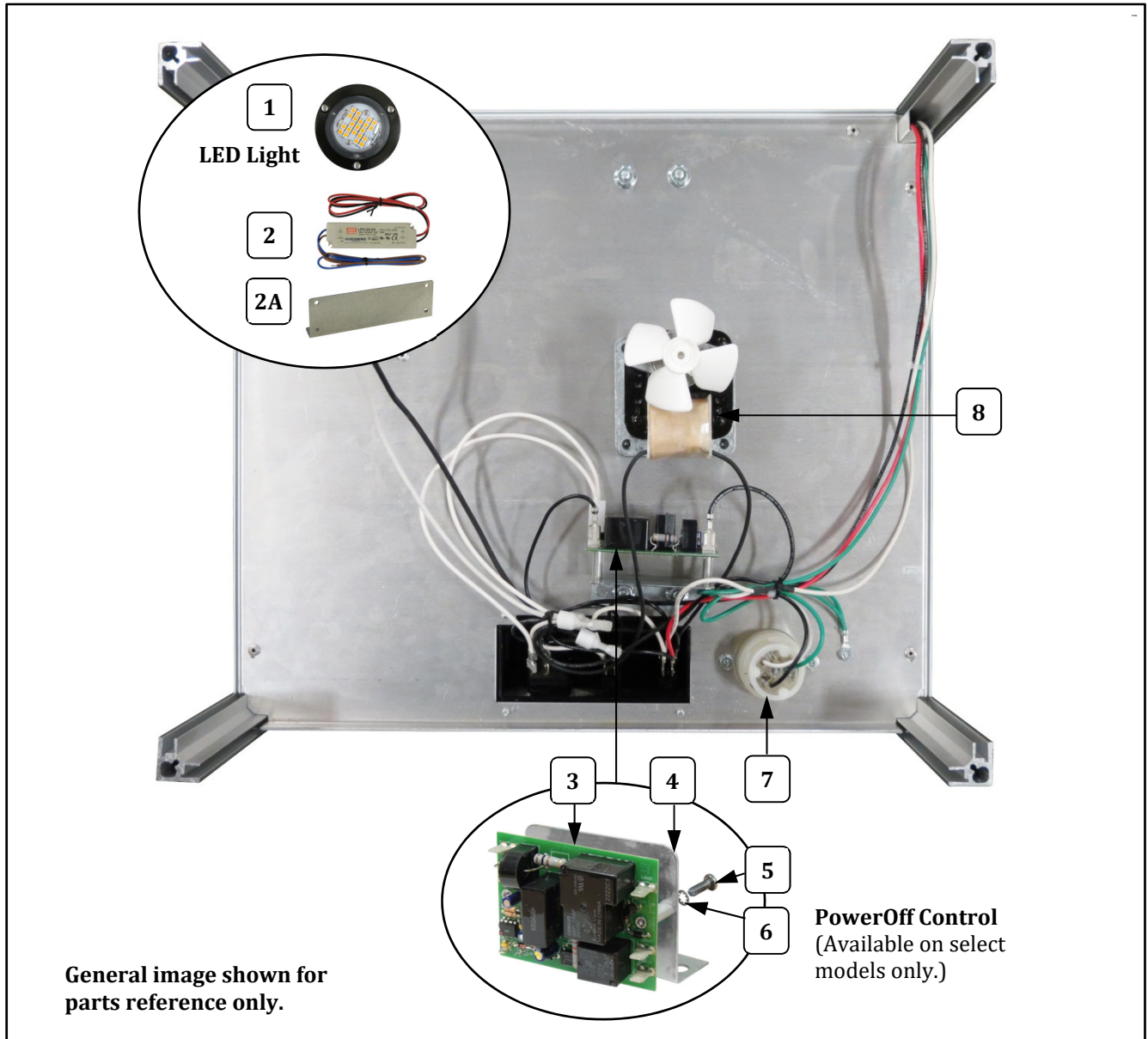

Item	Part Description	Part Number	
		2388	2388-00-002
1	LED REPLACEMENT NO PLATE	100544	100544
2	POWER SUPPLY 24VDC 20W	55394	55394
2A	20W POWER SUPPLY BRACKET	55414	55414
3	AUTO KETTLE POWEROFF CNTRL PCB		55402
4	BRACKET, KETTLE POWEROFF CNTRL		55427
5	6-32 X 3/8 PHIL PAN M/S		39000
6	#6 INTERNAL TOOTH L/W 410SS		39001
7	15 AMP TWIST LOCK KETTLE RECPT	49330	49330
8	120 VOLT KETTLE DRIVE MOTOR	47038	47038



Safety Labels

1 Unit Labels

2 UNPLUG THIS UNIT BEFORE CLEANING
DEBRANCHER CET APPAREIL AVANT NETTOYAGE
ZIEHN BEI DEN STECKER AUS DER STECKDOSE
BEVOR SIE DIE MASCHINE REINIGEN
DESCONECTE ESTA UNIDAD ANTES DE LIMPIARLA

3 42375

4 WARNING! CONTACT WITH THIS SURFACE WHILE THE APPLIANCE IS OPERATING MAY CAUSE BURNS
AVERTISSEMENT! CONTACT AVEC CETTE SURFACE PENDANT LE FONCTIONNEMENT DE L'APPAREIL POURRAIT CAUSER DES BRULURES
87087

5 powerOff
PATENT PENDING
WHEN THE HEAT SWITCH LIGHT IS BLINKING, TURN THE HEAT SWITCH OFF-ON TO RESTART THE KETTLE HEAT
On units with PowerOff Control feature only.

6 Kettle Lead-In Label

7 Power Cord Label

Item	Part Description	Part Number	
		2388	2388-00-002
1	UNIVERSAL POPPER DECAL	41019	41019
2	LABEL UNPLUG TO CLEAN	76097	76097
3	MAIN GROUND LABEL	42375	42375
4	WARNING, SURFACE CONTACT	87087	87087
5	LABEL POWEROFF CNTRL		55436
6	CONDUIT WARNING LABEL	82840	82840
7	WARNING LABEL CORD	68720	68720

Accessories

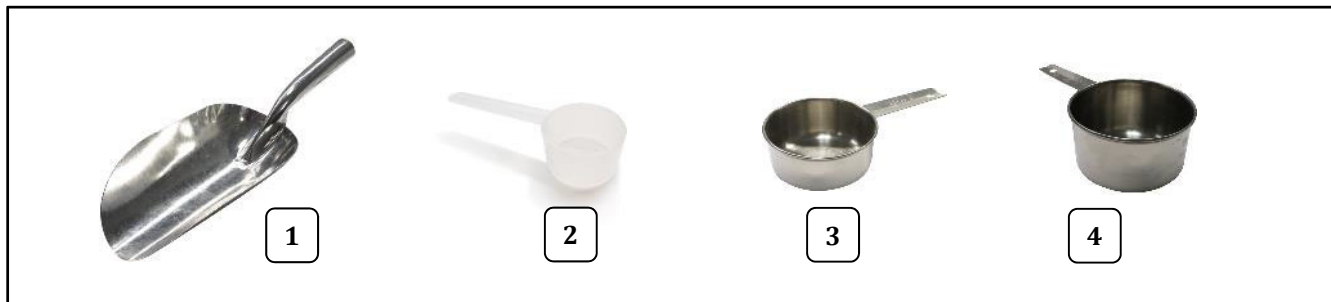

Item	Part Description	Part Number
1	STAMPED ALUMINUM SCOOP	2071
3	6.5 CC MEASURE	47678
4	OIL MEASURE (1/3 CUP)	47150
2	MEASURE ONE CUP	47147



Wiring Diagram

Model No. 2388

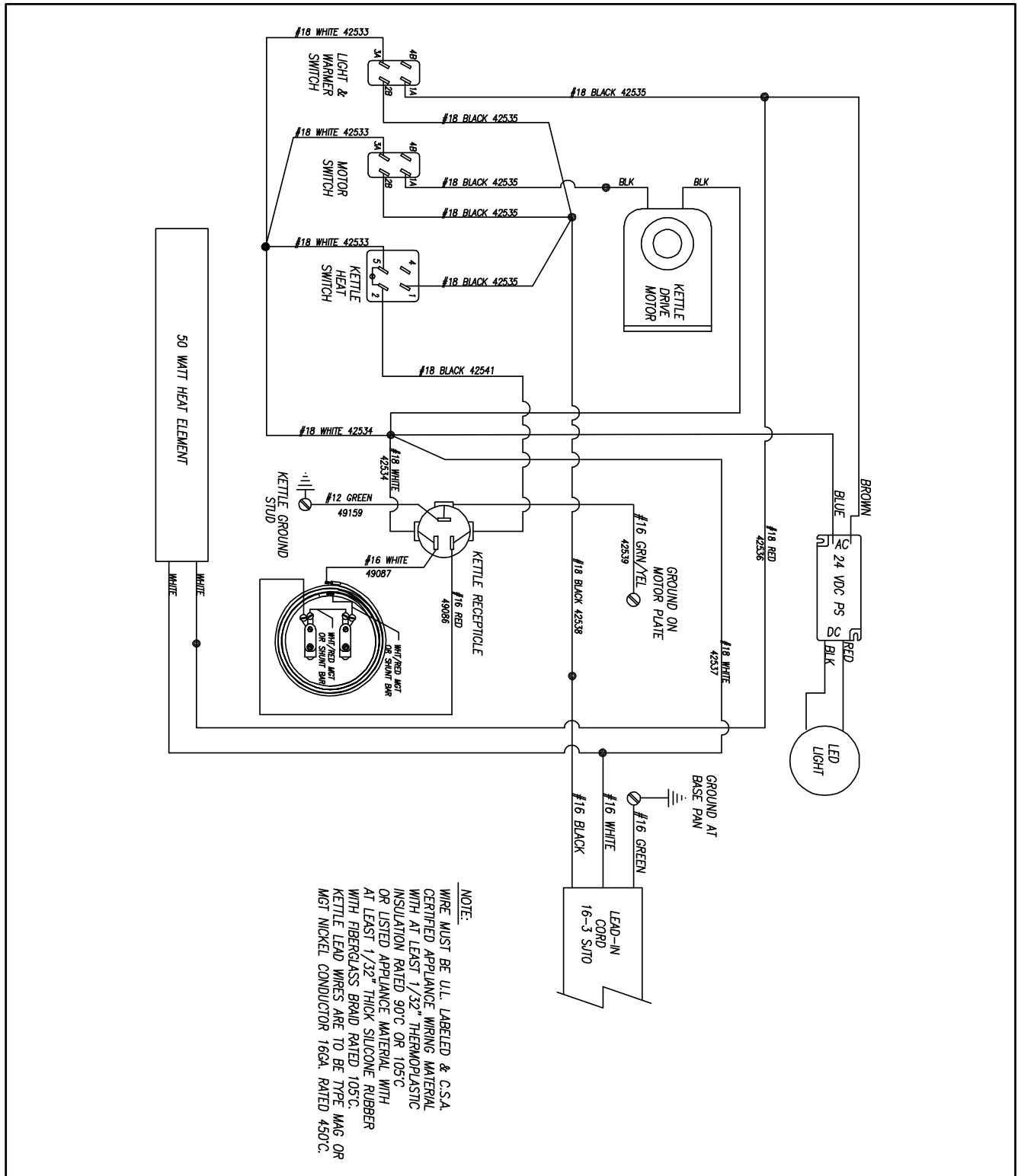



Model No. 2388-00-002

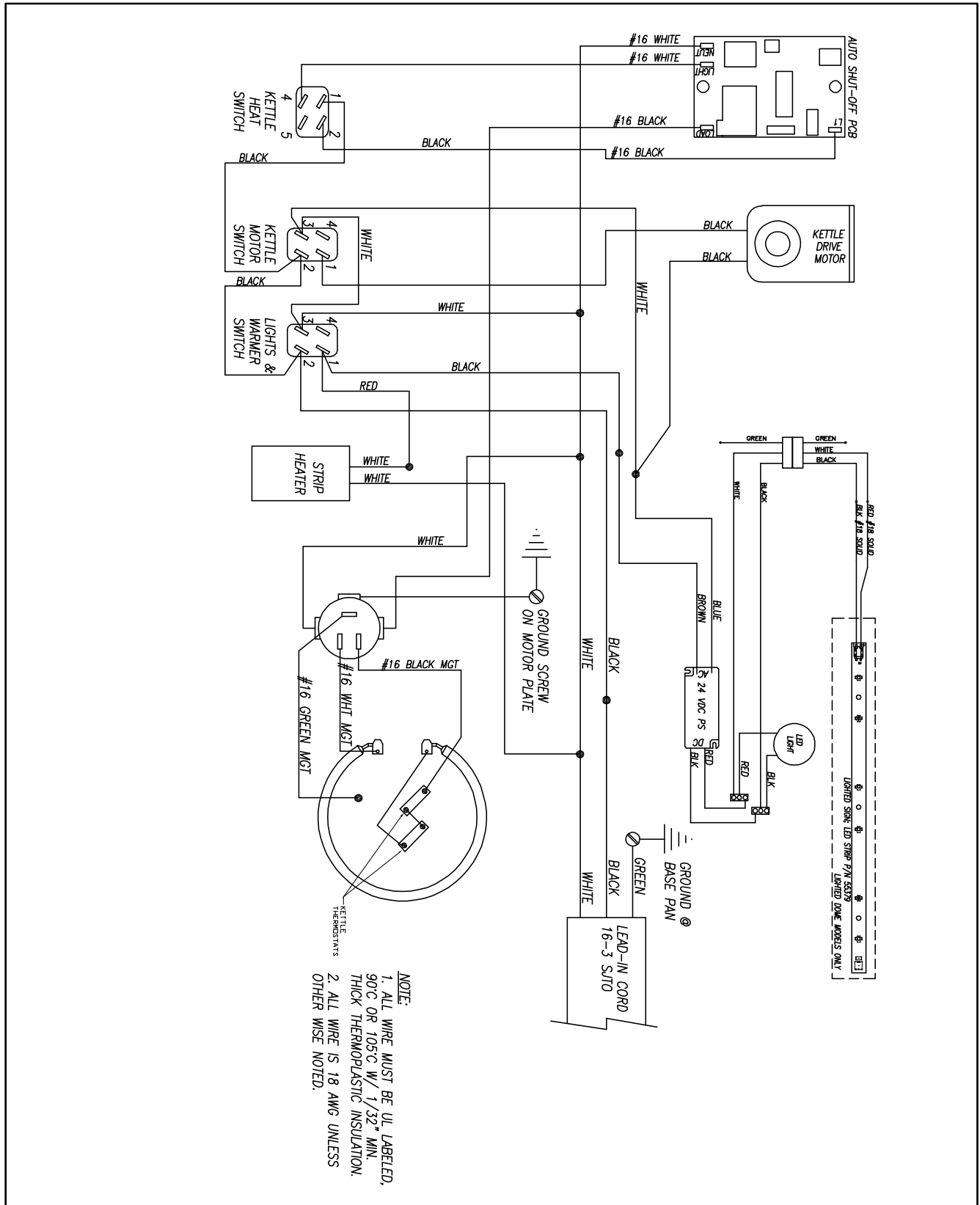

NOTE:
 1. ALL WIRE MUST BE UL LABELED,
 90°C OR 105°C W/ 1/32" MIN.
 THICK THERMOPLASTIC INSULATION.
 2. ALL WIRE IS 18 AWG UNLESS
 OTHER WISE NOTED.



WARRANTY

Gold Medal Products Co. warrants to the original purchaser each item of its manufacture to be free of defects in workmanship and material under normal use and service. Gold Medal Products Co.'s obligation under this warranty is limited solely to repairing or replacing parts, f.o.b. Cincinnati, Ohio, which in its judgment are defective in workmanship or material and which are returned, freight prepaid, to its Cincinnati, Ohio factory or other designated point. Except for "Perishable Parts" on specific machines, the above warranty applies for a period of two (2) years from the date of original sale to the original purchaser of equipment when recommended operating instructions and maintenance procedures have been followed. These are packed with the machine. Parts warranty is two (2) years, labor is six (6) months.

THIS WARRANTY IS IN LIEU OF ALL OTHER WARRANTIES EXPRESSED OR IMPLIED, AND OF ALL OTHER OBLIGATIONS OR LIABILITIES ON OUR PART, INCLUDING THE IMPLIED WARRANTY OF MERCHANTABILITY. THERE ARE NO WARRANTIES WHICH EXTEND BEYOND THE DESCRIPTION ON THE FACE HEREOF. In no event shall Gold Medal Products Co. be liable for special, incidental or consequential damages. No claim under this warranty will be honored if the equipment covered has been misused, neglected, damaged in transit, or has been tampered with or changed in any way. No claim under this warranty shall be honored in the event that components in the unit at the time of the claim were not supplied or approved by Gold Medal Products Co. This warranty is effective only when electrical items have been properly attached to city utility lines only at proper voltages. This warranty is not transferable without the written consent of Gold Medal Products Co.

The term "Original Purchaser" as used in this warranty shall be deemed to mean that person, firm, association, or corporation who was billed by the GOLD MEDAL PRODUCTS CO., or their authorized distributor for the equipment.

THIS WARRANTY HAS NO EFFECT AND IS VOID UNLESS THE ORIGINAL PURCHASER FIRST CALLS GOLD MEDAL PRODUCTS CO. AT 1-800-543-0862 TO DISCUSS WITH OUR SERVICE REPRESENTATIVE THE EQUIPMENT PROBLEM, AND, IF NECESSARY, FOR INSTRUCTIONS CONCERNING THE REPAIR OR REPLACEMENT OF PARTS.

NOTE: This equipment is manufactured and sold for commercial use only.



GOLD MEDAL[®] PRODUCTS CO.

10700 Medallion Drive, Cincinnati, Ohio 45241-4807 USA

gmpopcorn.com

Phone: (800) 543-0862 Fax: (800) 542-1496
(513) 769-7676 (513) 769-8500