

LOGO!

Manual

This manual has the order number:
6ED1050-1AA00-0BE7

Preface

Getting started with LOGO!	1
LOGO! installation and wiring	2
Programming LOGO!	3
LOGO! functions	4
Configuring LOGO!	5
LOGO! memory and battery cards	6
LOGO! software	7
Applications	8
Technical data	A
Determining the cycle time	B
LOGO! without display	C
LOGO! menu structure	D
Order numbers	E
Abbreviations	F

Legal information

Warning notice system

This manual contains notices you have to observe in order to ensure your personal safety, as well as to prevent damage to property. The notices referring to your personal safety are highlighted in the manual by a safety alert symbol, notices referring only to property damage have no safety alert symbol. These notices shown below are graded according to the degree of danger.

⚠ DANGER
indicates that death or severe personal injury will result if proper precautions are not taken.
⚠ WARNING
indicates that death or severe personal injury may result if proper precautions are not taken.
⚠ CAUTION
with a safety alert symbol, indicates that minor personal injury can result if proper precautions are not taken.
CAUTION
without a safety alert symbol, indicates that property damage can result if proper precautions are not taken.
NOTICE
indicates that an unintended result or situation can occur if the corresponding information is not taken into account.

If more than one degree of danger is present, the warning notice representing the highest degree of danger will be used. A notice warning of injury to persons with a safety alert symbol may also include a warning relating to property damage.

Qualified Personnel

The device/system may only be set up and used in conjunction with this documentation. Commissioning and operation of a device/system may only be performed by **qualified personnel**. Within the context of the safety notes in this documentation qualified persons are defined as persons who are authorized to commission, ground and label devices, systems and circuits in accordance with established safety practices and standards.

Proper use of Siemens products

Note the following:

⚠ WARNING
Siemens products may only be used for the applications described in the catalog and in the relevant technical documentation. If products and components from other manufacturers are used, these must be recommended or approved by Siemens. Proper transport, storage, installation, assembly, commissioning, operation and maintenance are required to ensure that the products operate safely and without any problems. The permissible ambient conditions must be adhered to. The information in the relevant documentation must be observed.

Trademarks

All names identified by ® are registered trademarks of the Siemens AG. The remaining trademarks in this publication may be trademarks whose use by third parties for their own purposes could violate the rights of the owner.

Disclaimer of Liability

We have reviewed the contents of this publication to ensure consistency with the hardware and software described. Since variance cannot be precluded entirely, we cannot guarantee full consistency. However, the information in this publication is reviewed regularly and any necessary corrections are included in subsequent editions.

Preface

We thank you for purchasing LOGO! and congratulate you on your decision. With LOGO! you have acquired a logic module that meets the stringent quality requirements of ISO 9001.

LOGO! can be used in many fields of applications. Due to its high functionality and easy operation, LOGO! offers you the utmost efficiency for almost any application.

Purpose of this manual

This LOGO! manual provides you with information about the creation of circuit programs, about the installation and use of LOGO! 0BA6 basic modules, the LOGO! TD (Text Display) and the LOGO! expansion modules, and about their compatibility with the previous 0BA0-0BA5 versions (0BAx are the last four characters of the order number of the basic modules and differentiate the device series).

LOGO!'s place in information technology

The wiring information in your LOGO! manual is also found in the LOGO! Product Info included with all devices. For further information on programming the LOGO! on your PC, refer to the Online Help for LOGO!Soft Comfort.

LOGO!Soft Comfort is LOGO! programming software for PCs. It runs under Windows® (including Windows Vista®), Linux®, and Mac OS X®. It helps you to get started with LOGO! and to write, test, print out and archive your programs, independent of the LOGO!.

Guide

The manual is divided into 8 chapters:

- Getting started with LOGO!
- LOGO! installation and wiring
- Programming LOGO!
- LOGO! functions
- Configuring LOGO!
- LOGO! memory and battery cards
- LOGO! software
- Applications

The manual also includes appendices A - F, which follow the chapters.

Valid range of this manual

The manual applies to devices of series 0BA6.

New features of the LOGO! 0BA6 device series

- The LOGO! TD (Text Display) provides an additional display device for messages, and contains four cursor keys and four functions keys that can be used in the circuit program.
- An additional password protection function is available in the LOGO! TD (version ES4 and later) and can only be enabled when the LOGO! TD is used together with LOGO! Basic modules (version ES4 and later).
- The new LOGO! Battery Card and the LOGO! Combined Memory/Battery Card provide up to two years of backup time for the real-time clock. The new LOGO! Memory Card and the Combined Memory/Battery Card provide 32 Kbytes memory space.
- Additional optional analog inputs and fast digital inputs are available on some of the LOGO! 0BA6 basic modules.
- LOGO! 0BA6 configuration menus can be displayed in one of ten supported languages. You have a configuration choice to specify the language for LOGO! menus.
- New instruction blocks are available: Pulse Width Modulator (PWM), Analog Math, and Analog Math Error Detection.
- Message texts can tick on and off the display; can include bar graphs, can switch between two character sets, and can be displayed on either the LOGO! Display, the LOGO! TD, or both. Full editing capabilities are available from LOGO!Soft Comfort; editing from the LOGO! Basic module is limited to simple text. See topic "Compatibility (Page 29)" for further details.
- A modem interface between a PC and LOGO! 0BA6 Basic module is supported, and is configurable only from LOGO!Soft Comfort. LOGO! 0BA6 supports the following modems:
 - INSYS Modem 336 4 1
 - INSYS Modem 56K small INT 2.0You can also use other modems with LOGO! 0BA6 provided that these modems meet the requirements specified in the "Connecting modems (Page 48)" topic.
- USB PC cable between a PC and LOGO! Basic module is available as an option.
- Modem cable between a modem and LOGO! Basic module is available as an option.
- This series supports 0/4–20 mA for the AM2 AQ analog outputs.
- You can now have up to 200 program blocks in your circuit program.

Additional differences compared to previous devices (0BA0 to 0BA5)

- Extended set of reference parameters for function blocks.
- Enhancements to up/down counter, hours counter, yearly timer and analog watchdog instruction blocks.
- You can find information on compatibility of LOGO! 0BA6 to previous devices in the "Compatibility (Page 29)" topic.

Additional support

Siemens LOGO! Website (<http://www.siemens.com/logo>)

E-Mail: adsupport@siemens.com

Table of contents

	Preface	3
1	Getting started with LOGO!.....	9
2	LOGO! installation and wiring	23
2.1	Modular LOGO! setup.....	26
2.1.1	Maximum setup.....	26
2.1.2	Setup with different voltage classes	27
2.1.3	Compatibility.....	29
2.2	Installing/removing LOGO!.....	29
2.2.1	DIN rail mounting	30
2.2.2	Wall-mounting	32
2.2.3	Mounting the LOGO! TD	33
2.2.4	Labeling LOGO!	33
2.3	Wiring LOGO!.....	34
2.3.1	Connecting the power supply.....	34
2.3.2	Connecting the LOGO! TD power supply	36
2.3.3	Connecting LOGO! inputs.....	37
2.3.4	Connecting outputs	43
2.3.5	Connecting the EIB bus	45
2.3.6	Connecting the AS interface bus	46
2.3.7	Connecting modems	48
2.4	Putting into operation	49
2.4.1	Switching the LOGO!/Power On	49
2.4.2	Putting a CM EIB/KNX into operation	50
2.4.3	Operating states.....	51
3	Programming LOGO!.....	53
3.1	Connectors.....	54
3.2	EIB inputs/outputs	56
3.3	Blocks and block numbers	57
3.4	From circuit diagram to LOGO! program	60
3.5	The four golden rules for operating LOGO!	63
3.6	Overview of LOGO! menus.....	65
3.7	Writing and starting the circuit program	66
3.7.1	Selecting programming mode	66
3.7.2	The first circuit program	67
3.7.3	Circuit program input.....	69
3.7.4	Assigning a circuit program name.....	73
3.7.5	Password	74
3.7.6	Switching LOGO! to RUN mode	79
3.7.7	Second circuit program	82
3.7.8	Deleting a block	87
3.7.9	Deleting block groups	88
3.7.10	Correcting programming errors.....	89

3.7.11	Selecting analog output values for RUN/STOP transition	89
3.7.12	Defining the type of analog outputs	90
3.7.13	Deleting the circuit program and password.....	91
3.7.14	Summertime/wintertime conversion.....	92
3.7.15	Synchronization.....	96
3.8	Memory space and circuit program size	97
4	LOGO! functions.....	101
4.1	Constants and connectors - Co	102
4.2	Basic functions list - GF	105
4.2.1	AND.....	106
4.2.2	AND with edge evaluation.....	107
4.2.3	NAND (not AND).....	108
4.2.4	NAND with edge evaluation	108
4.2.5	OR.....	109
4.2.6	NOR (not OR)	110
4.2.7	XOR (exclusive OR).....	111
4.2.8	NOT (Negation, Inverter).....	111
4.3	Special Functions.....	112
4.3.1	Designation of the inputs.....	112
4.3.2	Time response	113
4.3.3	Backup of the real-time clock.....	114
4.3.4	Retentivity.....	114
4.3.5	Parameter protection.....	114
4.3.6	Calculating the gain and offset of analog values	115
4.4	Special functions list - SF.....	117
4.4.1	On-delay.....	120
4.4.2	Off-delay.....	123
4.4.3	On-/Off-delay.....	124
4.4.4	Retentive on-delay	126
4.4.5	Wiping relay (pulse output)	127
4.4.6	Edge triggered wiping relay.....	128
4.4.7	Asynchronous pulse generator	130
4.4.8	Random generator	132
4.4.9	Stairway lighting switch.....	133
4.4.10	Multiple function switch	136
4.4.11	Weekly timer	138
4.4.12	Yearly timer	142
4.4.13	Up/down counter	147
4.4.14	Hours counter.....	150
4.4.15	Threshold trigger	154
4.4.16	Analog threshold trigger.....	157
4.4.17	Analog differential trigger	160
4.4.18	Analog comparator.....	163
4.4.19	Analog watchdog.....	167
4.4.20	Analog amplifier	170
4.4.21	Latching relay.....	172
4.4.22	Pulse relay.....	173
4.4.23	Message texts	175
4.4.24	Softkey	186
4.4.25	Shift register	188
4.4.26	Analog Multiplexer.....	190
4.4.27	Analog Ramp	192

4.4.28	PI controller	196
4.4.29	Pulse Width Modulator (PWM).....	201
4.4.30	Analog math	204
4.4.31	Analog math error detection.....	207
5	Configuring LOGO!	211
5.1	Selecting parameter assignment mode	212
5.1.1	Parameters.....	213
5.1.2	Selecting the parameters	214
5.1.3	Modifying parameters	215
5.2	Setting the default values for LOGO!.....	217
5.2.1	Setting the time of day and date (LOGO! ... C).....	218
5.2.2	Setting the display contrast and backlight choice	219
5.2.3	Setting the menu language.....	220
5.2.4	Setting the number of AIs in the Basic Module.....	221
5.2.5	Setting the start screen	222
6	LOGO! memory and battery cards	223
6.1	Security function (CopyProtect)	225
6.2	Inserting and removing memory and battery cards	227
6.3	Copying data from LOGO! to the memory card	229
6.4	Copying data from the memory card to LOGO!.....	230
7	LOGO! software.....	233
7.1	LOGO! software	233
7.2	Connecting LOGO! to a PC	235
8	Applications	237
A	Technical data	239
A.1	General technical data	239
A.2	Technical data: LOGO! 230.....	241
A.3	Technical data: LOGO! DM8 230R and LOGO! DM16 230R	243
A.4	Technical data: LOGO! 24.....	245
A.5	Technical data: LOGO! DM8 24 and LOGO! DM16 24	247
A.6	Technical data: LOGO! 24RC.....	249
A.7	Technical data: LOGO! DM8 24R and LOGO! DM16 24R.....	251
A.8	Technical data: LOGO! 12/24... LOGO! DM8 12/24R	253
A.9	Switching capacity/service life of the relay outputs.....	255
A.10	Technical data: LOGO! AM 2.....	256
A.11	Technical data: LOGO! AM 2 PT100	257
A.12	Technical data: LOGO! AM 2 AQ (6ED1055 - 1MM00 - 0BA0).....	258
A.13	Technical data: LOGO! AM 2 AQ (6ED1055 - 1MM00 - 0BA1).....	259
A.14	Technical data: CM EIB/KNX.....	260
A.15	Technical data: CM AS Interface	261

A.16	Technical data: LOGO!Power 12 V.....	262
A.17	Technical data: LOGO!Power 24 V.....	263
A.18	Technical data: LOGO! Contact 24/230.....	264
A.19	Technical data: LOGO! TD (Text Display).....	265
A.20	Technical data: Battery information for LOGO! cards.....	265
B	Determining the cycle time.....	267
C	LOGO! without display.....	269
D	LOGO! menu structure	271
D.1	LOGO! Basic Module	271
D.2	LOGO! TD	275
E	Order numbers.....	277
F	Abbreviations.....	279
	Index.....	281

Getting started with LOGO!

Here's LOGO!

LOGO! is a universal logic module made by Siemens that integrates:

- Controls
- Operator and display panel with background lighting
- Power supply
- Interface for expansion modules
- Interface for a memory card, battery card, combined memory/battery card, LOGO! PC cable or USB PC cable.
- Interface for an optional text display (TD) module
- Pre-configured standard functions, for example, on- and off-delays, pulse relay and softkey
- Timers
- Digital and analog flags
- Inputs and outputs, according to the device type

What LOGO! can do for you

LOGO! offers solutions for domestic and installation engineering applications such as stairway lighting, external lighting, sun blinds, shutters, shop window lighting and more; switch cabinet engineering, as well as for mechanical and apparatus engineering such as gate control systems, air-conditioning systems, and rainwater pumps.

LOGO! can also be implemented for special control systems in conservatories or greenhouses, for control signal processing and, by connecting a communication module such as an AS-i module, for distributed local controlling of machines and processes.

Special versions without operator panel and display unit are available for series production applications in small machine, apparatus, switching cabinet and installation engineering.

Which devices are available?

LOGO! Basic is available in two voltage classes:

- Class 1 ≤ 24 V, i.e. 12 V DC, 24 V DC, 24 V AC
- Class 2 > 24 V, i.e. 115...240 V AC/DC

LOGO! Basic is available in two versions:

- **With display:** 8 inputs and 4 outputs
- **Without display** ("LOGO! Pure"): 8 inputs and 4 outputs

Each version is integrated into four subunits, is equipped with an expansion interface and LOGO! TD interface and provides 39 pre-configured standard and special function blocks for the creation of your circuit program.

Which expansion modules are available?

- LOGO! digital modules DM8... are available for operation with 12 V DC, 24 V AC/DC and 115...240 V AC/DC, and are equipped with four inputs and four outputs.
- LOGO! digital modules DM16... are available for operation with 24 V DC and 115...240 V AC/DC, and are equipped with eight inputs and eight outputs.
- LOGO! analog modules are available for operation with 24 V DC and some with 12 V DC, depending on the specific module. Each is equipped with two analog inputs, two Pt100 inputs or two analog outputs.

The digital/analog modules are integrated in two or four subunits. Each one is equipped with two expansion interfaces for connecting additional modules.

Which display modules are available?

- LOGO! Basic with display
- LOGO! TD

Features of the LOGO! TD

The LOGO! TD is available with the 0BA6 series. It provides an additional display that is wider than the Basic module. It has four function keys that you can program in your circuit program as inputs. Like the LOGO! Basic module, it has four cursor keys, an ESC key and an OK key that you can also program in your circuit program and use for navigation on the LOGO! TD.

You can create and download a power-up screen for the LOGO! TD from LOGO!Soft Comfort. This screen displays briefly when you initially power on the LOGO! TD. You can also upload the power-up screen from the LOGO! TD to LOGO!Soft Comfort.

The menus for the LOGO! TD are shown in Appendix section D.2. You configure the settings for the LOGO! TD independently from the LOGO! Basic module. The settings can be different.

Which communication modules are available?

- LOGO! communication module (CM) AS interface, which is described in more detail in a separate documentation.

The communication module has four virtual inputs and outputs, and acts as an interface between an AS-Interface system and a LOGO! system. The module enables four data bits to be transferred from the LOGO! Basic to the AS-Interface system and vice versa.

- LOGO! communication module (CM) EIB/KNX, which is described in more detail in a separate documentation.

CM EIB/KNX is a communication module (CM) for connecting the LOGO! to the *EIB*.

As an interface to *EIB*, CM EIB/KNX makes it possible to communicate with other *EIB* devices. To do this, you store a configuration in the CM EIB/KNX that specifies the inputs/outputs of the LOGO! to the *EIB* bus that are to be mapped. You can interconnect the corresponding inputs/outputs using LOGO! functions.

It's your choice

The various LOGO! Basic versions, expansion modules, LOGO! TD and communication modules offer you a highly flexible and adaptive system to suit your specific tasks.

The LOGO! system offers you many solutions such as for small domestic installations, simple automation tasks, and even complex engineering tasks involving its integration into a bus system (e.g. communication module AS interface).

Note

LOGO! Basic may only be equipped with expansion modules of the same voltage class. Mechanical encoding pins in the housing prevent you from connecting devices of a different voltage class.

Exception: The left-hand interface of an analog module or communication module is galvanically isolated.

This type of expansion module can therefore be connected to devices of a different voltage class (Page 27).

A LOGO! TD, if used, can be connected to only one LOGO! pure module.

Each LOGO! Basic supports the following connections for the creation of the circuit program, regardless of the number of connected modules:

- Digital inputs
 - I1 to I24
 - Analog inputs AI1 to AI8
 - Digital outputs Q1 to Q16
 - Analog outputs AQ1 to AQ2
 - Digital flag blocks M1 to M27:
 - M8: Startup flag
 - M25: Backlight flag: LOGO! Display
 - M26: Backlight flag: LOGO! TD
 - M27: Message text character set flag
 - Analog flag blocks AM1 to AM6
 - Shift register bits S1 to S8
 - 4 cursor keys
 - 16 blank outputs X1 to X16
-

The LOGO! structure

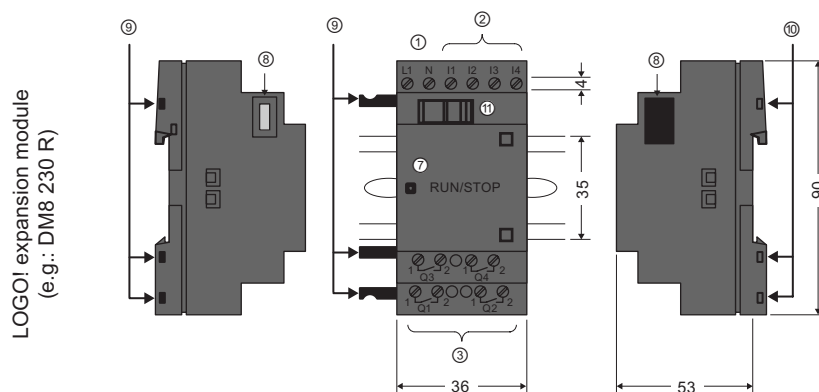
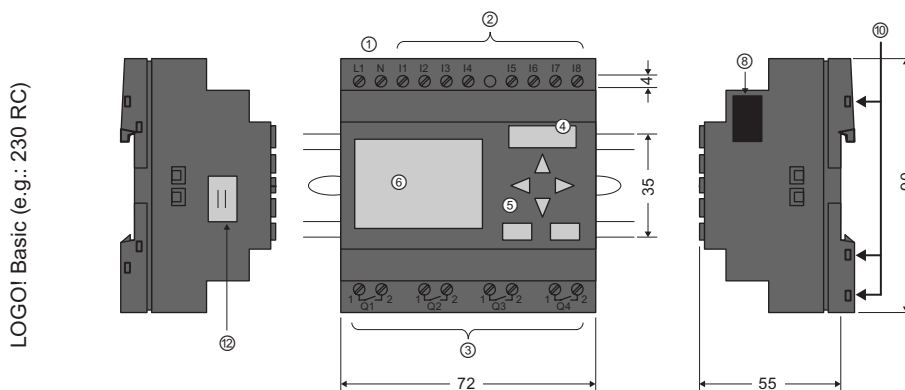

- ① Power supply
- ② Inputs
- ③ Outputs
- ④ Module slot with cap
- ⑤ Control panel (nor for RCo)
- ⑥ LCD (not for RCo)
- ⑦ RUN/STOP indicator
- ⑧ Expansion interface
- ⑨ Mechanical coding pins
- ⑩ Mechanical coding sockets
- ⑪ Slide
- ⑫ LOGO! TD cable connector

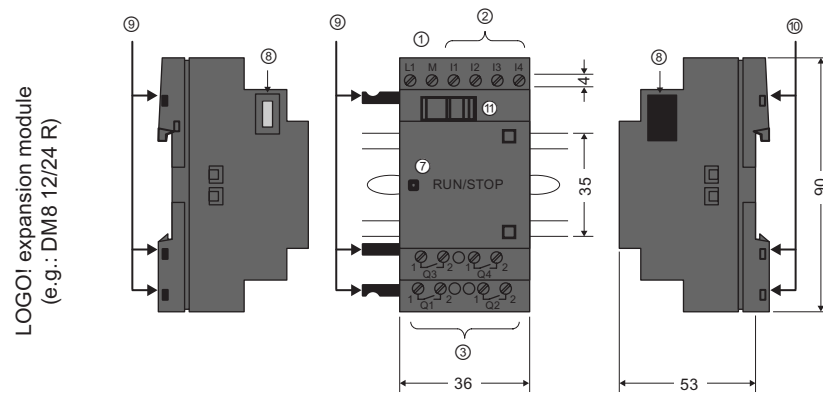
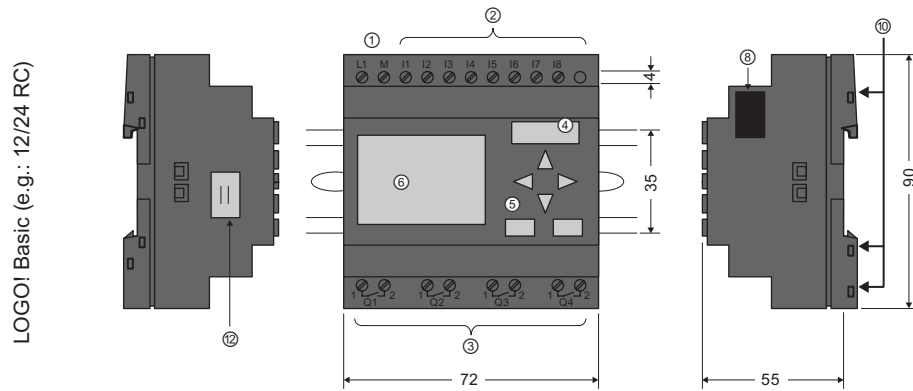

- | | |
|-------------------------------|-----------------------------|
| ① Power supply | ⑦ RUN/STOP indicator |
| ② Inputs | ⑧ Expansion interface |
| ③ Outputs | ⑨ Mechanical coding pins |
| ④ Module slot with cap | ⑩ Mechanical coding sockets |
| ⑤ Control panel (not for RCo) | ⑪ Slide |
| ⑥ LCD (not for RCo) | ⑫ LOGO! TD cable connector |

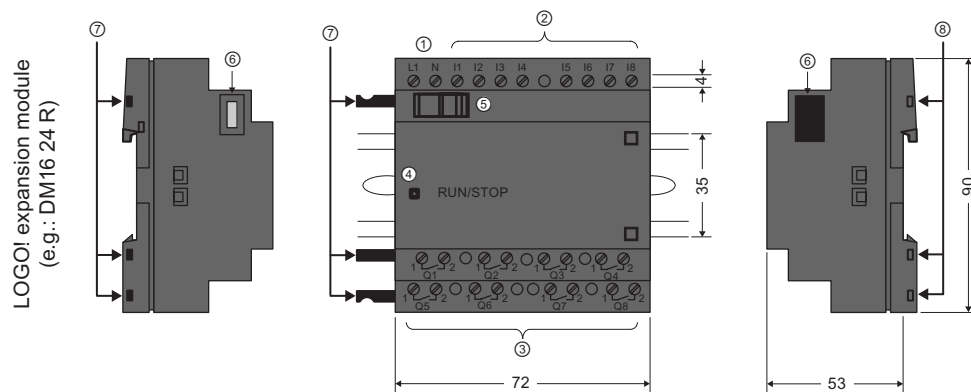

- | | |
|----------------------|-----------------------------|
| ① Power supply | ⑤ Slide |
| ② Inputs | ⑥ Expansion interface |
| ③ Outputs | ⑦ Mechanical coding pins |
| ④ RUN/STOP indicator | ⑧ Mechanical coding sockets |

LOGO! AM2

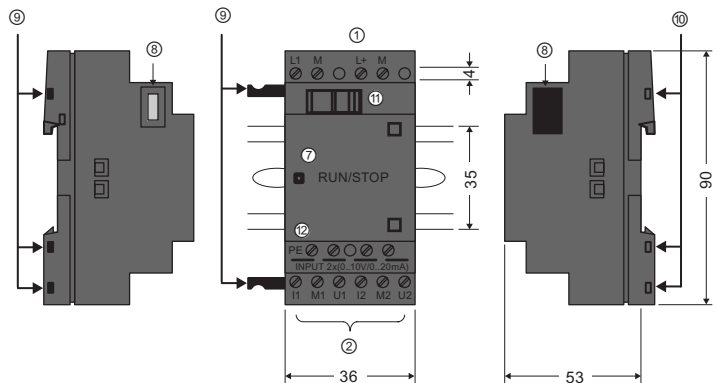

- ① Power supply
- ② Outputs
- ⑦ RUN/STOP indicator
- ⑧ Expansion interface
- ⑨ Mechanical coding pins
- ⑩ Mechanical coding sockets
- ⑪ Slide
- ⑫ PE terminal, for connecting earth and the shielding of analog measuring cables

LOGO! AM 2 AQ (0 ... 10 V DC)

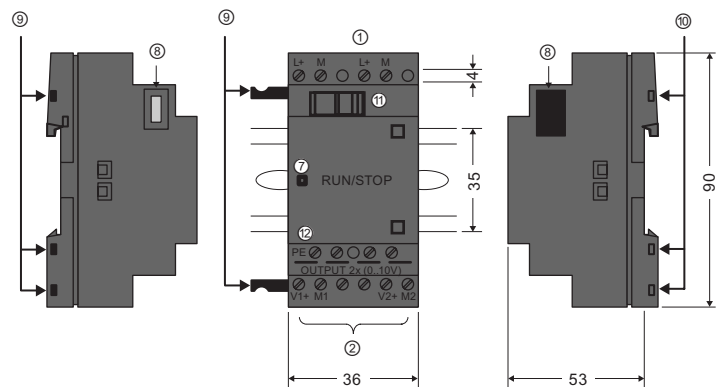

- ① Power supply
- ② Outputs
- ⑦ RUN/STOP indicator
- ⑧ Expansion interface
- ⑨ Mechanical coding pins
- ⑩ Mechanical coding sockets
- ⑪ Slide
- ⑫ PE terminal, for connecting earth

LOGO! AM2 AQ (0 ... 10 V DC or 0/4 ... 20 mA)

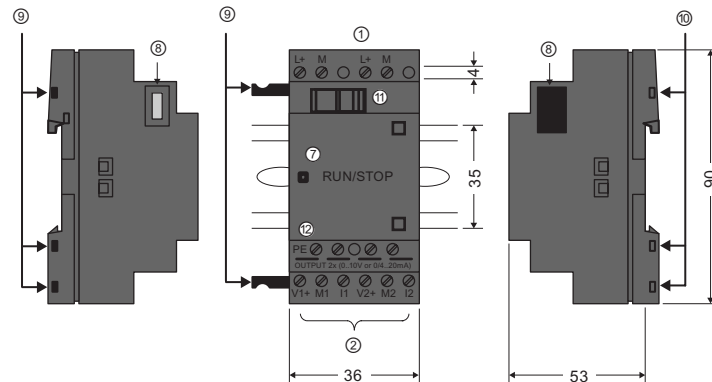

- | | | | |
|---|---------------------|---|-----------------------------------|
| ① | Power supply | ⑨ | Mechanical coding pins |
| ② | Inputs | ⑩ | Mechanical coding sockets |
| ⑦ | RUN/STOP indicator | ⑪ | Slide |
| ⑧ | Expansion interface | ⑫ | PE terminal, for connecting earth |

Note

The LOGO! AM 2 AQ module (6ED1055 - 1MM00 - 0BA1) is available with the LOGO! 0BA6 basic module.

LOGO! CM EIB/KNX

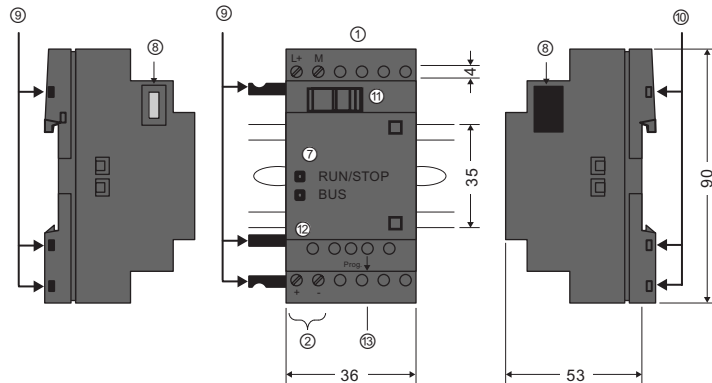

- | | | | |
|---|------------------------|---|-----------------------------------|
| ① | Power supply | ⑩ | Mechanical coding sockets |
| ② | EIB bus connection | ⑪ | Slide |
| ⑦ | RUN/STOP indicator | ⑫ | LED for status display of EIB/KNX |
| ⑧ | Expansion interface | ⑬ | Programming button |
| ⑨ | Mechanical coding pins | | |

LOGO! TD

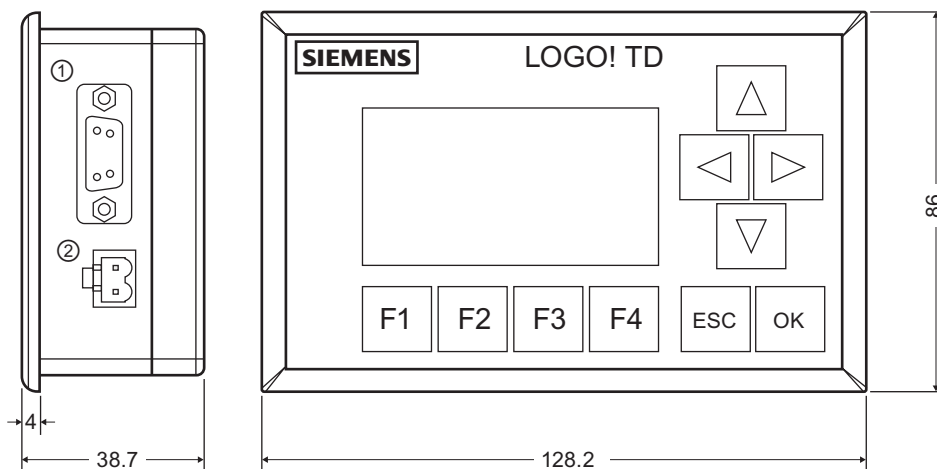

① Communication interface

② Power supply







The LOGO! TD includes a wider display area than the LOGO! Display. It includes four programmable cursor keys, four programmable function keys, and an ESC and OK key. You use the included LOGO! TD cable to connect from the communication interface on the right side of the LOGO! TD to the corresponding interface on the left side of the LOGO! Basic module.

How to identify LOGO!

The LOGO! identifier informs you of various properties:



- 12/24: 12/24 V DC version
- 230: 115...240 V AC/DC version
- R: Relay outputs (without R: solid-state outputs)
- C: Integrated weekly timer
- o: Version without display ("LOGO! Pure")
- DM: Digital module
- AM: Analog module
- CM: Communication module (e.g. EIB/KNX module)
- TD: Text Display

Symbols

	<p>Version with display unit is equipped with 8 inputs and 4 outputs</p>
	<p>Version without display unit is equipped with 8 inputs and 4 outputs</p>
	<p>The digital module is equipped with 4 digital inputs and 4 digital outputs</p>
	<p>The digital module is equipped with 8 digital inputs and 8 digital outputs</p>
	<p>The analog module is equipped with 2 analog inputs or 2 analog outputs, according to the device type</p>
	<p>The communication module (CM); for example, AS Interface is equipped with 4 virtual inputs and 4 virtual outputs</p>
	<p>The LOGO! TD</p>

Versions



The following LOGO! versions are available:

Symbol	Designation	Supply voltage	Inputs	Outputs	Properties
	LOGO! 12/24 RC	12/24 V DC	8 digital ¹⁾	4 relays (10 A)	
	LOGO! 24	24 V DC	8 digital ¹⁾	4 solid state 24V / 0.3A	no clock
	LOGO! 24RC ³⁾	24 V AC/ 24 V DC	8 digital	4 relays (10A)	
	LOGO! 230RC ²⁾	115...240 V AC/DC	8 digital	4 relays (10A)	
	LOGO! 12/24RCo	12/24 V DC	8 digital ¹⁾	4 relays (10A)	no display unit no keyboard
	LOGO! 24o	24 V DC	8 digital ¹⁾	4 solid state 24 V / 0.3A	no display unit no keyboard no clock
	LOGO! 24RCo ³⁾	24 V AC / 24 V DC	8 digital	4 relays (10A)	no display unit no keyboard
	LOGO! 230RCo ²⁾	115...240 V AC/DC	8 digital	4 relays (10A)	no display unit no keyboard

- 1) Of those can be used alternatively: 4 analog inputs (0 ... 10V) and 4 fast digital inputs.
- 2) 230 V AC versions: Two groups consisting of 4 inputs each. Each input within a group must be connected to the same phase. It is possible to interconnect groups with a different phase.
- 3) The digital inputs can be operated with P or N action.

Expansion modules

The following expansion modules can be connected to LOGO!:

Symbol	Name	Power supply	Inputs	Outputs
	LOGO! DM 8 12/24R	12/24 V DC	4 digital	4 relays (5A)
	LOGO! DM 8 24	24 V DC	4 digital	4 solid state 24V / 0.3A
	LOGO! DM 8 24R ³⁾	24 V AC/DC	4 digital	4 relays (5A)
	LOGO! DM 8 230R	115...240 V AC/DC	4 digital ¹⁾	4 relays (5A)
	LOGO! DM 16 24	24 V DC	8 digital	8 solid state 24V / 0.3A
	LOGO! DM 16 24R	24 V DC	8 digital	8 relays (5A)
	LOGO! DM 16 230R	115...240 V AC/DC	8 digital ⁴⁾	8 relays (5A)
	LOGO! AM 2	12/24 V DC	2 analog 0 ... 10V or 0 ... 20mA ²⁾	None
	LOGO! AM 2 PT100	12/24 V DC	2 Pt100 -50 degrees C to +200 degrees C	None
	LOGO! AM 2 AQ	24 V DC	None	2 analog 0 ... 10 V DC 0/4...20mA ⁵⁾

- 1) Different phases are not allowed within the inputs.
- 2) 0 ... 10 V, 0 ... 20 mA can be connected optionally.
- 3) Digital inputs can be operated either with P or with N action.
- 4) Two groups consisting of 4 inputs each. Each input within a group must be connected to the same phase. It is possible to interconnect groups with a different phase.
- 5) 0/4 ... 20mA current output is only available for 6ED1055 - 1MM00 - 0BA1, and 0 ... 10 V, 0/4 ... 20mA can be connected optionally.

Communication modules

The following communication modules can be connected to LOGO!:

Symbol	Name	Power supply	Inputs	Outputs
	LOGO! CM AS Interface	30 V DC	the next four inputs after the physical inputs of LOGO! (In ... In+3)	the next four outputs after the physical outputs of LOGO! (Qn ... Qn+3)
	LOGO! CM EIB/KNX	24 V AC/DC	max. 16 virtual digital inputs (I); max. 8 virtual analog inputs (AI)	max. 12 virtual digital outputs (Q); max. 2 virtual analog outputs (AQ)

Text Display Module

The following LOGO! TD module is available:

Symbol	Name	Supply voltage	Display
	LOGO! TD	24 V AC/DC 12 V DC	LCD (128 x 64) 4-row display

Certification and approvals

LOGO! is certified to cULus and FM.

- cULus Haz. Loc.
Underwriters Laboratories Inc. (UL) to
 - UL 508 (Industrial Control Equipment)
 - CSA C22.2 No. 142 (Process Control Equipment)
 - UL 1604 (Hazardous Location)
 - CSA-213 (Hazardous Location)APPROVED for use in
Class I, Division 2, Group A, B, C, D Tx
Class I, Zone 2, Group IIC Tx
- FM Approval
Factory Mutual Research (FM) to
Approval Standard Class Number 3611, 3600, 3810
APPROVED for use in
Class I, Division 2, Group A, B, C, D Tx
Class I, Zone 2, Group IIC Tx

Note

You will find current approvals on the rating plate of the relevant module.

LOGO! is issued with the CE Certificate of Conformity. It is compliant with IEC 60730-1 and IEC 61131-2 and interference-proof to EN 55011, Limit Class B.

Marine certification has been requested.

- ABS (American Bureau of Shipping)
- BV (Bureau Veritas)
- DNV (Det Norske Veritas)
- GL (Germanischer Lloyd)
- LRS (Lloyds Register of Shipping)
- Class NK (Nippon Kaiji Kyokai)
- PRS (Polski Rejestr Statkow)

LOGO! modules are therefore suitable for use in industrial and residential areas. Use in Class I, Division 2, Group A, B, C and D locations or in non-hazardous locations is supported.

ID for Australia



Our products carrying the label shown at the side are compliant with AS/NZS 2064:1997 (Class A) standard.

WARNING

Risk of death, personal injury or property damage can occur if you do not follow safety precautions for hazardous locations.

In potentially explosive atmospheres, do not disconnect connectors when the system is in RUN. Always switch off the power supply to LOGO! and its components before you disconnect any connectors or components.

Substitution of components can impair suitability for Class I, Division 2 locations. Combinations of equipment are subject to investigation by the local authority having jurisdiction at the time of the installation.

Recycling and Disposal

LOGO! units can be fully recycled, due to their low-pollutant equipment. Contact a certified electronic waste disposal center for environmentally acceptable recycling and disposal of your old devices.

LOGO! installation and wiring

General guidelines

Please note the following guidelines for installing and wiring your LOGO!:

- Always ensure that the wiring of your LOGO! is compliant with current rules and standards. Also, conform with all national and regional regulations when you install and operate the devices. For information on standards and regulations that apply to your specific case, contact your local authorities.
- Always switch off power before you wire or install/remove a module.
- Always use cables with appropriate conductor cross-sections for the relevant current. You can wire LOGO! with cable conductor cross-sections (Page 34) from 1.5 mm² to 2.5 mm².
- Do not exceed the screw torque of the terminals. The maximum torque is: 0.5 Nm..
- Keep the cabling as short as possible. If longer cables are necessary, you should use shielded versions. You should always route your cables in pairs: i.e. one neutral conductor plus one phase conductor or signal line.
- Always keep separate:
 - The AC wiring
 - High-voltage DC circuits with high-frequency switching cycles
 - Low-voltage signal wiring
 - The EIB bus cable may also be laid in parallel to other signal lines
- Ensure that the wires are installed with appropriate strain relief.
- Provide a suitable lightning surge arrester for cables installed in hazardous areas.
- Do not connect an external power supply in parallel to the output load of a DC output. This could develop a reverse current at the output if you have not installed a diode or similar barrier device.
- Reliable functioning of the equipment is only ensured with certified components!

Note

LOGO! devices may only be installed and wired by skilled personnel who are familiar with and follow general engineering rules and relevant regulations and standards.

What you must note when installing

LOGO! is designed for fixed and enclosed installation in the housing or the control cabinet.

WARNING

Death, serious bodily injury or considerable damage to property can occur.

Modules of a LOGO! are open facilities. This means that you must install LOGO! only in a housing or cabinet.

Allow access to the housings or cabinets only with the use of a key or a tool and only allow access to authorized or approved personnel.

It is permissible to operate LOGO! from the front at any time.

Safety of electronic control equipment

Introduction

The notes below apply regardless of the type or manufacturer of the electronic control.

Reliability

Maximum reliability of LOGO! devices and components is achieved by implementing extensive and cost-effective measures during development and manufacture.

This includes the following:

- Use of high-quality components
- Worst-case design of all circuits
- Systematic and computer-aided testing of all components
- Burn-in of all large-scale integrated circuits (e.g. processors, memory, etc.)
- Measures preventing static charge when handling MOS ICs
- Visual checks at different stages of manufacture
- Continuous heat-run test at elevated ambient temperature over a period of several days
- Careful computer-controlled final testing
- Statistical evaluation of all returned systems and components to enable the immediate initiation of suitable corrective measures
- Monitoring of major control components, using online tests (cyclic interrupt for the CPU, etc.)

These measures are referred to as basic measures.

Carrying out tests

You must, however, ensure safety in your plant.

Before finally commissioning a system, carry out complete functional testing as well as all the necessary safety testing.

In testing, also include any predictable faults that can occur. This means that you will avoid any danger to the plant or to people during operation.

Risks

In all cases where the occurrence of failures can result in material damage or injury to persons, special measures must be taken to enhance the safety of the installation - and therefore also of the situation. System-specific and special regulations exist for such applications. They must be observed on installing the control system (for example, VDE 0116 for burner control systems).

For electronic control equipment with a safety function, the measures that have to be taken to prevent or rectify faults are based on the risks involved in the installation. Beyond a certain degree of hazard the basic measures mentioned above are not sufficient. Additional measures must be implemented and approved for the controller.

Important information

The instructions in the operating manual must be followed exactly. Incorrect handling can render measures intended to prevent dangerous faults ineffective, or generate additional sources of danger.

2.1 Modular LOGO! setup

2.1.1 Maximum setup

LOGO! supports a maximum of 24 digital inputs, 8 analog inputs, 16 digital outputs, and 2 analog outputs (Page 9). You can achieve the maximum setup in different ways as shown below:

Maximum setup of a LOGO! *with* analog inputs - four in use (LOGO! 12/24 RC/RCo and LOGO! 24/24o)

LOGO! Basic, 4 digital modules and 3 analog modules (example)

I1, I2, I3 .. I6, I7, I8 AI3, AI4, AI1, AI2	I9..I12	I13..I16	I17..I20	I21..I24	AI5, AI6	AI7, AI8	
LOGO! Basic	LOGO! DM 8	LOGO! DM 8	LOGO! DM 8	LOGO! DM 8	LOGO! AM 2	LOGO! AM 2	LOGO! AM2 AQ
Q1..Q4	Q5..Q8	Q9..Q12	Q13..Q16				AQ1, AQ2

Maximum setup of a LOGO! *with* analog inputs - two in use (LOGO! 12/24 RC/RCo and LOGO! 24/24o)

LOGO! Basic, 4 digital modules and 4 analog modules (example)

I1, I2, I3 .. I6, I7, I8 AI1, AI2	I9..I12	I13..I16	I17..I20	I21..I24	AI3, AI4	AI5, AI6	AI7, AI8	
LOGO! Basic	LOGO! DM 8	LOGO! DM 8	LOGO! DM 8	LOGO! DM 8	LOGO! AM 2	LOGO! AM 2	LOGO! AM 2	LOGO! AM2 AQ
Q1..Q4	Q5..Q8	Q9..Q12	Q13..Q16					AQ1, AQ2

Maximum setup of a LOGO! *without* analog inputs (LOGO! 24RC/RCo and LOGO! 230 RC/RCo)

LOGO! Basic, 4 digital modules and 5 analog modules (example)

I1 I8	I9..I12	I13..I16	I17..I20	I21..I24	AI1, AI2	AI3, AI4	AI5, AI6	AI7, AI8	
LOGO! Basic	LOGO! DM 8	LOGO! DM 8	LOGO! DM 8	LOGO! DM 8	LOGO! AM 2	LOGO! AM 2	LOGO! AM 2	LOGO! AM 2	LOGO! AM2 AQ
Q1..Q4	Q5..Q8	Q9..Q12	Q13..Q16						AQ1, AQ2

For LOGO! 12/24 RC/RCo and LOGO! 24/240 modules, you can configure whether the module uses two or four of the four possible analog inputs. AI inputs are numbered consecutively depending on how many you configure the basic module to use. If you configure two inputs, they are numbered AI1 and AI2, and correspond to the I7 and I8 input terminals. Subsequent AI expansions modules would begin numbering at AI3. If you configure four inputs, they are numbered AI1, AI2, AI3, and AI4, and correspond to I7, I8, I1, and I2 in that order. Subsequent AI expansions modules would begin numbering at AI5. See topics "Constants and connectors - Co (Page 102)" and "Setting the number of AIs in the Basic Module (Page 221)".

High-speed/optimal communication performance

For optimal and high-speed communication performance between LOGO! Basic and the various modules, we recommend that you install the digital modules first, then the analog modules (examples above). (The special function PI controller is an exception: the AI used for the value PV should be on the LOGO! Basic or an analog input module adjacent to the LOGO! Basic).

We **recommend** that you position the CM AS Interface on the far right-hand side. (If the AS Interface voltage fails, communication between the LOGO! system and expansion modules that are arranged to the right of the LOGO! CM AS Interface expansion module is interrupted).

The LOGO! TD module is installed separately. You connect it to the LOGO! Basic module with the included LOGO! TD cable.

Note

CM EIB/KNX must always be installed as the last module on the right-hand side of LOGO! as no further interface modules may be connected to the CM EIB/KNX.

2.1.2 Setup with different voltage classes

Rules

Digital modules can only be directly connected to devices of the same voltage class.

You can connect analog and communication modules to devices of any voltage class.

You can replace two similar DM8 expansion modules by one appropriate DM16 expansion module (and vice versa) without having to change the circuit program.

Note

Two DM8 12/24R can be replaced by one DM16 24R only if operated with a power supply of 24 V DC.

Two DM8 24R can be replaced by one DM16 24R only if operated with DC and P action.

Overview: Connecting an expansion module to LOGO! Basic

In the following tables, "X" means that the connection is possible; "-" means that the connection is not possible.

LOGO! Basic	Expansion modules					
	DM8 12/24R, DM16 24R	DM8 24, DM16 24	DM 8 24R	DM8 230R, DM16 230R	AM2, AM2 PT100, AM2 AQ	CM
LOGO! 12/24 RC	x	x	x	-	x	x
LOGO! 24	x	x	x	-	x	x
LOGO! 24 RC	x	x	x	-	x	x
LOGO! 230 RC	-	-	-	x	x	x
LOGO! 12/24RCo	x	x	x	-	x	x
LOGO! 24o	x	x	x	-	x	x
LOGO! 24 RCo	x	x	x	-	x	x
LOGO! 230 RCo	-	-	-	x	x	x

Overview: Connecting an additional expansion module to an expansion module

Expansion module	Additional expansion modules					
	DM8 12/24R, DM16 24R	DM8 24, DM16 24	DM 8 24R	DM8 230R, DM16 230R	AM2, AM2 PT100, AM2 AQ	CM
DM 8 12/24R, DM 16 24R	x	x	x	-	x	x
DM 8 24, DM 16 24	x	x	x	-	x	x
DM 8 24 R	x	x	x	-	x	x
DM 8 230R, DM 16 230R	-	-	-	x	x	x
AM 2, AM 2 PT100, AM 2 AQ	x	x	x	-	x	x
CM AS Interface	x	x	x	-	x	x

2.1.3 Compatibility

The LOGO! TD module can only be used with equipment series 0BA6.

You cannot edit message texts from the LOGO! Basic module that contain any of the following parameters:

- Par
- Time
- Date
- EnTime
- EnDate

You can only edit such message texts from LOGO!Soft Comfort.

When using the LOGO! AM 2 AQ analog module with equipment series 0BA4 or 0BA5, the functions are limited to the ones available on this equipment. You cannot use the module with equipment series 0BA3 or earlier.

All other expansion modules are completely compatible with the basic modules of equipment series 0BA3, 0BA4, 0BA5, and 0BA6.

2.2 Installing/removing LOGO!

Dimensions

The LOGO! installation dimensions are compliant with DIN 43880.

LOGO! can be snap-mounted to 35 mm DIN rails to EN 50022 or on the wall.

LOGO! width:

- LOGO! TD has a width of 128.2 mm, which corresponds to 8 subunits
- LOGO! Basic modules have a width of 72 mm, which corresponds to 4 subunits
- LOGO! expansion modules have a width of 36 mm or 72 mm (DM16...), which corresponds to 2 or 4 subunits

Note

The figure below shows you an example of the installation and removal of a LOGO! 230 RC and a digital module. The measures shown apply to all other LOGO! Basic versions and expansion modules.

 WARNING
--

Always switch off power before you "remove" or "insert" an expansion module.
--

2.2.1 DIN rail mounting

Mounting

How to **mount** a LOGO! Basic module **and** a digital module onto a DIN rail:

1. Hook the LOGO! Basic module onto the rail.
2. Push down the lower end to snap it on. The mounting interlock at the rear must engage.

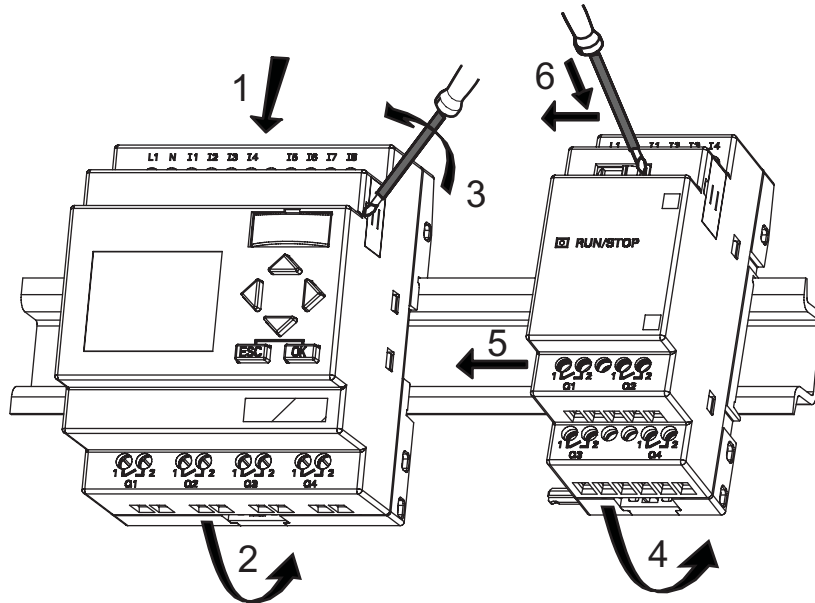

3. On the right side of the LOGO! Basic/LOGO! expansion module, remove the connector cap.
4. Place the digital module onto the DIN rail on the right-hand side of the LOGO! Basic.
5. Slide the digital module towards the left until it contacts the LOGO! Basic.
6. Using a screwdriver, push the interlock to the left. In its end position the slide interlock engages in LOGO! Basic.

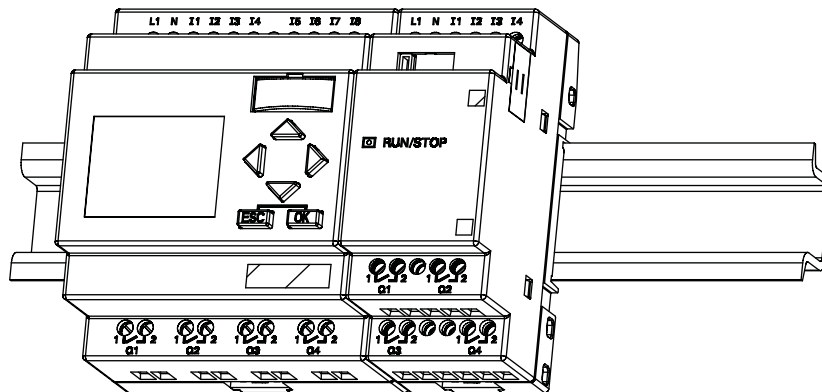

Repeat the digital module steps to mount further expansion modules.

Note

The expansion interface on the last expansion module must be covered.

Removal

To **remove** LOGO!:

..... if you have installed **only one** LOGO! **Basic**:

1. Insert a screwdriver into the eyelet at the bottom of the slide interlock and move the latch downward.
2. Swing the LOGO! Basic off the DIN rail.

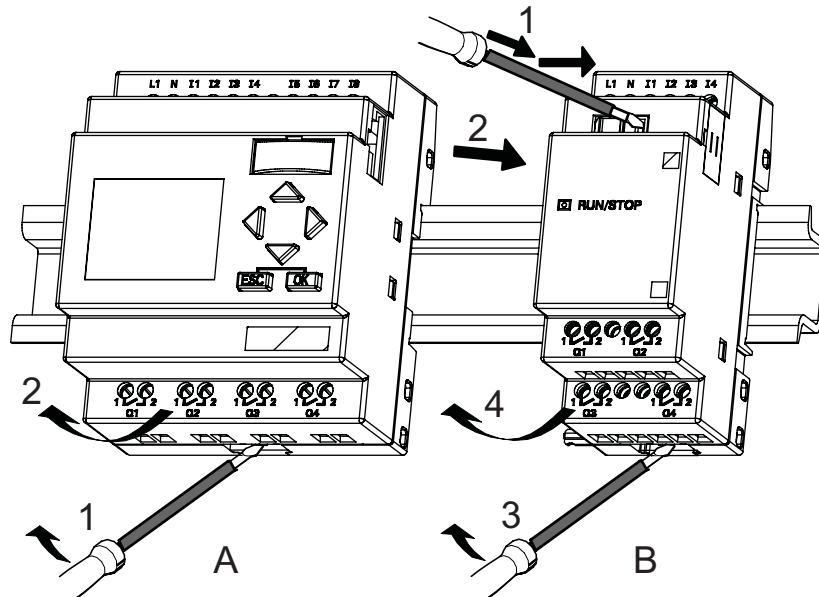

..... if you have connected **at least one expansion module** to LOGO! Basic:

1. Using a screwdriver, push the integrate slide interlock to the right.
2. Slide the expansion module off towards the right.
3. Insert a screwdriver into the eyelet at the bottom of the slide interlock and lever it downward.
4. Swing the expansion module off the profile rail.

Repeat steps 1 to 4 for all other expansion modules.

Note

If you have connected more than one expansion module, it is advisable to start removal with the last module at the right-hand side.

Make sure the slide interlock of the module to be installed/removed is not engaged in the next module.

2.2.2 Wall-mounting

For wall-mounting, first slide the mounting slides on the rear side of the devices towards the **outside**. You can now wall-mount LOGO! by means of two mounting slides and two Ø M4 screws (tightening torque 0.8 to 1.2 Nm).

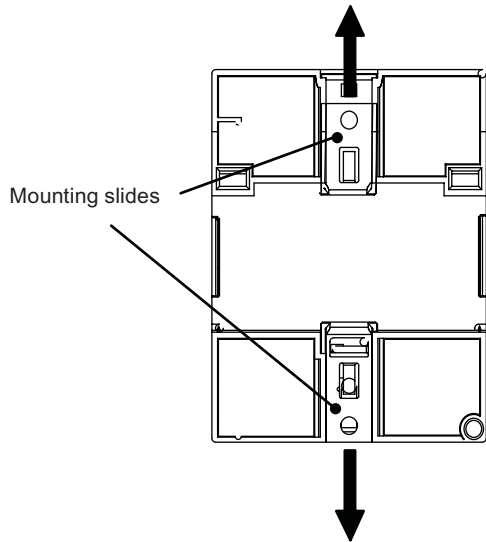

Drilling template for wall-mounting

Before you can wall-mount LOGO!, you need to drill holes using the template shown below.

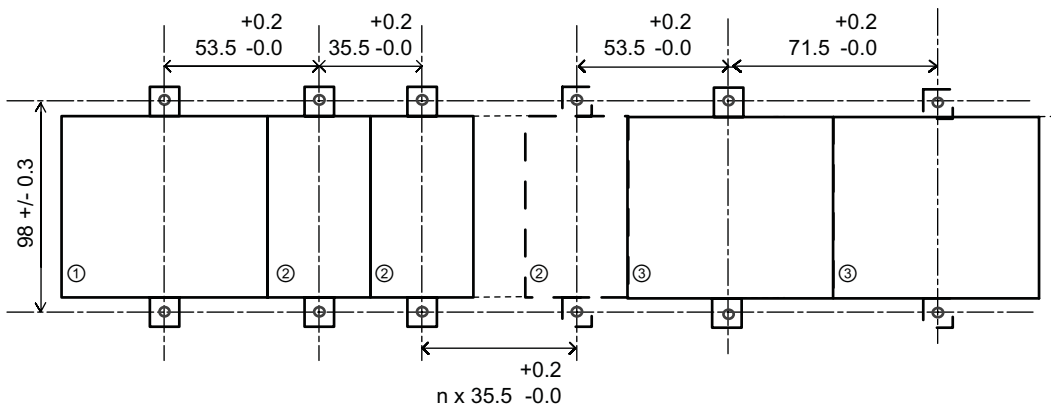

All dimensions in mm

Bore hole for Ø M4 screw, tightening torque 0.8 to 1.2 Nm

- ① LOGO! Basic
- ② LOGO! expansion modules, DM *..., AM...
- ③ LOGO! expansion modules, DM 16...

2.2.3 Mounting the LOGO! TD

To prepare the mounting surface for the optional LOGO! TD and mount it, follow these steps:

1. Cut a 119.5 mm x 78.5 mm (tolerance: +0.5 mm) hole in the mounting surface.

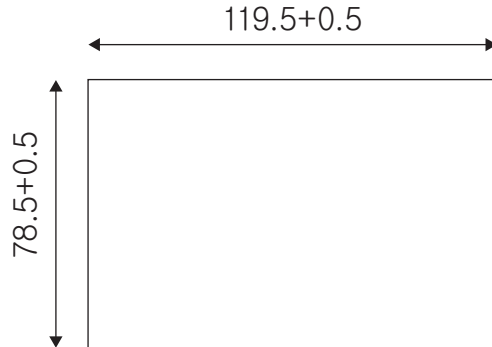

2. Place the included gasket on the frontplate of the LOGO! TD.
3. Fit the LOGO! TD into the cutout you made in the mounting surface.
4. Attach the mounting brackets (included) to the LOGO! TD.
5. Tighten the mounting screws on the mounting brackets to 0.2 Nm torque to secure the LOGO! TD.

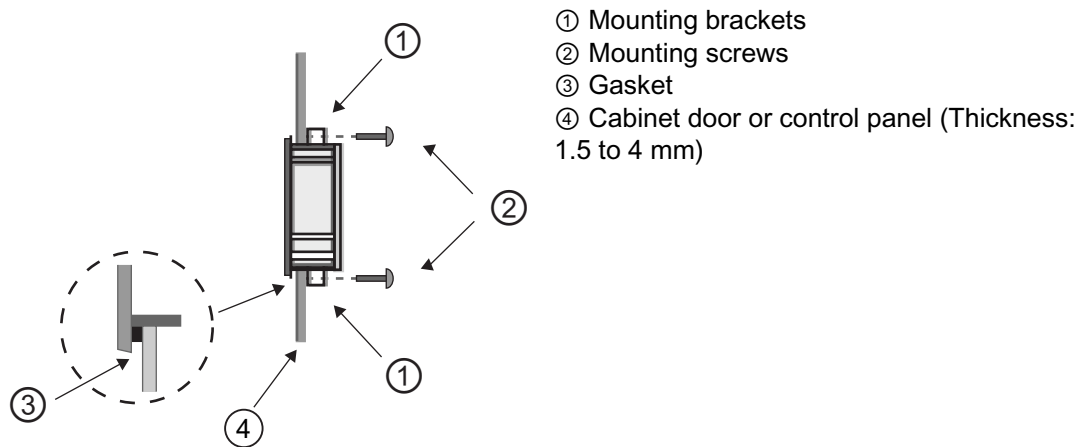

You can then use the included cable to connect the LOGO! TD to the LOGO! Basic module up to a distance of 2.5 meters. You can extend this distance to up to ten meters by using a standard Sub-D cable together with the LOGO! TD cable.

2.2.4 Labeling LOGO!

The gray rectangular areas on the LOGO! modules are intended for labeling.

In the case of expansion modules, you can use the gray areas for labeling the inputs and outputs, for example. In this connection, you can enter a delta factor of +8 for the inputs or +4 for the outputs if the basic module already has 8 inputs or 4 outputs.

2.3 Wiring LOGO!

Wire LOGO! using a screwdriver with a 3-mm blade.

You do not need wire ferrules for the terminals. You can use conductors with cross-sections of up to the following thicknesses:

- 1 x 2.5 mm²
- 2 x 1.5 mm² for each second terminal chamber

Tightening torque: 0.4...0.5 Nm or 3...4 in-lbs.

Note

Always cover the terminals after you have completed the installation. To protect LOGO! adequately from impermissible contact to live parts, comply with local standards.

2.3.1 Connecting the power supply

The 230-V versions of LOGO! are suitable for operation with rated voltages of 115 V AC/DC and 240 V AC/DC. The LOGO! 24-V and 12-V versions can be operated with a 24 VDC, 24 V AC or 12 V DC power supply. For information on permissible voltage tolerances, line frequencies and power consumption, refer to the installation instructions in the Product Information supplied with your device and to the technical data in Appendix A.

The CM EIB/KNX has been designed as a communication module for the LOGO! controller and must be supplied with a mains voltage of 12/24 V AC/DC.

The AS Interface bus requires a special AS Interface power supply (30 V DC) that enables simultaneous transmission of data and power for the encoders via a single line.

The LOGO! TD must be supplied with a voltage of 12 V DC or 24 V AC/DC.

Note

A power failure might cause an additional edge triggering signal at the special functions. The stored data will be from the last uninterrupted cycle.

Connecting LOGO!

To connect LOGO! to the power supply:

LOGO! ... with DC power supply

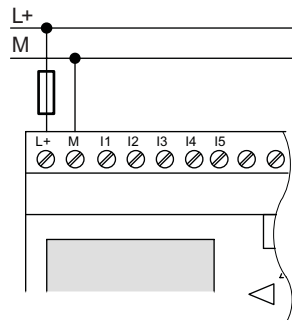

Protection with safety fuse
if required (recommended) for:

12/24 RC...:	0.8 A
24:	2.0 A
EIB/KNX	0.08 A

LOGO! ... with AC power supply

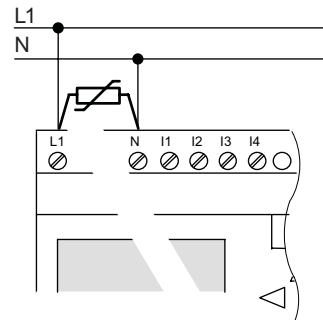

To suppress surge voltages, install
varistors (MOV) with an operating
voltage at least 20 % above the rated
voltage.

Note

LOGO! is a double-insulated switchgear. You do not need to connect an equipment grounding conductor.

Circuit protection with AC voltage

To suppress voltage peaks on the power supply lines, you can install a metal oxide varistor (MOV). Make sure the operating voltage of the varistor (MOV) used lies at least 20 % above the rated voltage (for example S10K275).

Circuit protection with DC voltage

To suppress voltage peaks on the power supply lines, please install a protection device. DEHN (order number: 918 402) is recommended.

2.3.2 Connecting the LOGO! TD power supply

The LOGO! TD must be connected to an external power supply that supplies a voltage of 12 V DC or 24 V AC/DC. A power connector is included with the LOGO! TD.

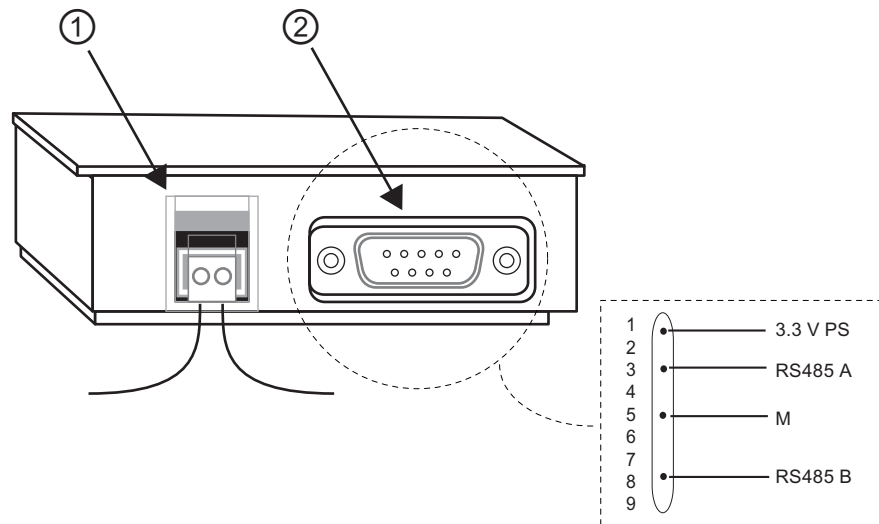

- ① Power supply
- ② Communication interface

The power connection is non-polar. If you connect a DC power supply to the LOGO! TD, you can connect the positive supply wire or negative supply wire to either the left or right side.

Note

Siemens recommends that you protect the LOGO! TD with a 0.5 A safety fuse on the power supply.

2.3.3 Connecting LOGO! inputs

Requirements

At the inputs you connect sensor elements such as: momentary pushbuttons, switches, light barriers, daylight control switches etc.

Sensor characteristics for LOGO!

	LOGO! 12/24 RC/RCo		LOGO! 24/24o		LOGO! DM8 12/24 R	LOGO! DM8 24
	I3 ... I6	I1,I2,I7,I8	I3 ... I6	I1,I2,I7,I8	I1 ... I8	I1 ... I8
Signal status 0	< 5 V DC	< 5 V DC	< 5 V DC	< 5 V DC	< 5 V DC	< 5 V DC
Input current	< 0.85 mA	< 0.05 mA	< 0.85 mA	< 0.05 mA	< 0.85 mA	< 0.85 mA
Signal status 1	> 8.5 V DC	> 8.5 V DC	> 12 V DC	> 12 V DC	> 8.5 V DC	> 12 V DC
Input current	> 1.5 mA	> 0.1 mA	> 2 mA	> 0.15 mA	> 1.5 mA	> 2 mA

	LOGO! 24 RC/RCo (AC) LOGO! DM8 24 R (AC)	LOGO! 24 RC/RCo (DC) LOGO! DM8 24 R (DC)	LOGO! 230 RC/RCo (AC) LOGO! DM8 230 R (AC)	LOGO! 230 RC/RCo (DC) LOGO! DM8 230 R (DC)
Signal status 0	< 5 V AC	< 5 V DC	< 40 V AC	< 30 V DC
Input current	< 1.0 mA	< 1.0 mA	< 0.03 mA	< 0.03 mA
Signal status 1	> 12 V AC	> 12 V DC	> 79 V AC	> 79 V DC
Input current	> 2.5 mA	> 2.5 mA	> 0.08 mA	> 0.08 mA

	LOGO! DM16 24 R	LOGO! DM16 24	LOGO! DM16 230 R (AC)	LOGO! DM16 30 R (DC)
Signal status 0	< 5 V DC	< 5 V DC	< 40 V AC	< 30 V DC
Input current	< 1.0 mA	< 1.0 mA	< 0.05 mA	< 0.05 mA
Signal status 1	> 12 V DC	> 12 V DC	> 79 V AC	> 79 V DC
Input current	> 2.0 mA	> 2.0 mA	> 0.08 mA	> 0.08 mA

Note

The digital inputs of LOGO! 230 RC/RCo and of expansion module DM16 230R are divided into two groups, each consisting of four inputs. **Within** the same group, all inputs must be operated on the **same** phase. **Different** phases are only possible **between** the groups.

Example: I1 to I4 on phase **L1**, I5 to I8 on phase **L2**.

Inputs within the LOGO! DM8 230R may **not** be connected to different phases.

Sensor connections

Connecting glow lamps and 2-wire proximity switches (Bero) to LOGO! 230 RC/230 RCo or LOGO! DM8 230 R (AC) and LOGO! DM16 230R (AC)

The figure below shows how you connect a switch with a glow lamp to LOGO!. The current that flows through the glow lamp allows LOGO! to detect a "1" signal even though the switch contact is not closed. If, however, you use a switch the glow lamp of which is fitted with a power supply, this response does not occur.

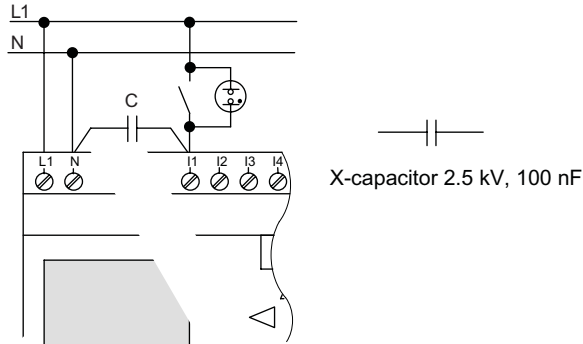

Take into account the quiescent current of any 2-wire proximity switches used. The level of the quiescent current of some 2-wire proximity switches is high enough to trigger a logical "1" signal at the LOGO! input. You should therefore compare the quiescent current of the proximity switches with the technical data of inputs (Page 239).

Remedy

To suppress this response, use an X capacitor rated at 100 nF and 2.5 kV. In a destructive situation, this type of capacitor safely disconnects. You must choose the voltage level for which the capacitor is rated such that it is not destroyed in the case of overvoltage!

At 230 V AC, the voltage between N and an input I(n) must not be greater than 40 V to guarantee a "0" signal. You can connect approximately ten glow lamps to the capacitor.

Restrictions

Signal status transitions 0 → 1 / 1 → 0:

After a 0 to 1 or 1 to 0 transition, the signal must remain constant at the input at least for the duration of one program cycle, so that LOGO! can detect the new signal status.

The program execution time is determined by the size of the circuit program. The appendix "Determining the cycle time (Page 267)" contains a benchmark test routine that you can use to determine the current scan cycle time.

Special features of LOGO! 12/24 RC/RCo and LOGO! 24/24o

Fast digital inputs: I3, I4, I5 and I6:

These versions are also equipped with fast digital inputs (up/down counters, threshold triggers). The restrictions mentioned earlier do not apply to these fast digital inputs.

Note

The fast digital inputs I3, I4, I5 and I6 are the same as in the previous versions 0BA0 to 0BA5; therefore, a circuit program that is written in these versions can be transferred to the new 0BA6 devices with the programming software LOGO!Soft Comfort, without any changes to these features. In contrast to this, you need to modify circuit programs written for a LOGO!...L version (fast digital inputs I11-I12). The fast digital inputs have increased from 2 kHz to 5 kHz with the 0BA6 series.

Expansion modules do not have fast digital inputs.

Analog inputs: I1 and I2, I7 and I8:

The inputs I1, I2, I7 and I8 of LOGO! versions 12/24RC/RCo and 24/24o can be used as either digital inputs or analog inputs. The input mode is defined in the LOGO! circuit program.

The inputs I1, I2, I7 and I8 provide digital inputs, and the inputs AI3, AI4, AI1 and AI2 provide analog inputs, as described in the topic "Constants and connectors - Co (Page 102)". AI3 corresponds to the input terminal I1; AI4 corresponds to I2; AI1 corresponds to I7; AI2 corresponds to I8. The use of AI3 and AI4 is optional. You configure your LOGO! to use either two or four analog inputs as described in topic "Setting the number of AIs in the Basic Module (Page 221)".section 5.2.4.

When using inputs I1, I2, I7 and I8 as analog inputs, only the range from 0 to 10 V DC is available.

Connecting a potentiometer to inputs I1, I2, I7 and I8

To allow you to achieve 10 V as the maximum value when you completely turn the potentiometer once, you must connect a series resistor on the potentiometer's input side regardless of the input voltage (see figure below).

We suggest the following sizes of potentiometers and associated series resistors:

Voltage	Potentiometer	Series Resistor
12 V	5 k Ω	-
24 V	5 k Ω	6.6 k Ω

When using a potentiometer and 10 V input voltage as the maximum value, you must ensure that with a connected input voltage of 24 V, 14 V must release via the series resistor so that a maximum of 10 V are supplied when you turn the potentiometer one full rotation. With a voltage of 12 V, this can be neglected.

Note

The LOGO! AM 2 expansion module provides additional analog inputs. The LOGO! AM 2 PT100 expansion module provides PT100 inputs.

Always use twisted and shielded cables for analog signals, and keep these as short as possible.

Sensor connections

To connect sensors to LOGO! :

LOGO! 12/24

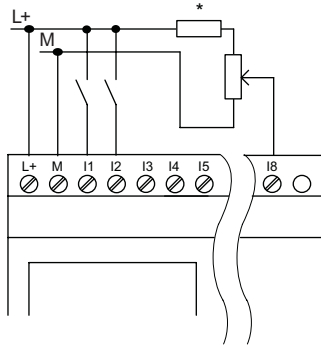

The inputs of these devices are not isolated and therefore require a common reference potential (chassis ground).
 With LOGO! 12/24RC/RCo and LOGO! 24/24o modules, you can tap analog signals between the supply voltage and chassis ground
 (* = series resistor with 24 V DC).

LOGO! 230

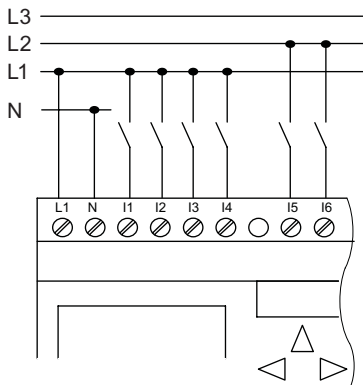

The inputs of these devices are arranged in 2 groups, each consisting of 4 inputs. Different phases are only possible between blocks, but not within the blocks.

 WARNING
<p>Current safety regulations (VDE 0110, ... and IEC 61131-2, ... as well as cULus) do not permit the connection of different phases to an AC input group (I1 to I4 or I5 to I8) or to the inputs of a digital module.</p>

LOGO! AM 2

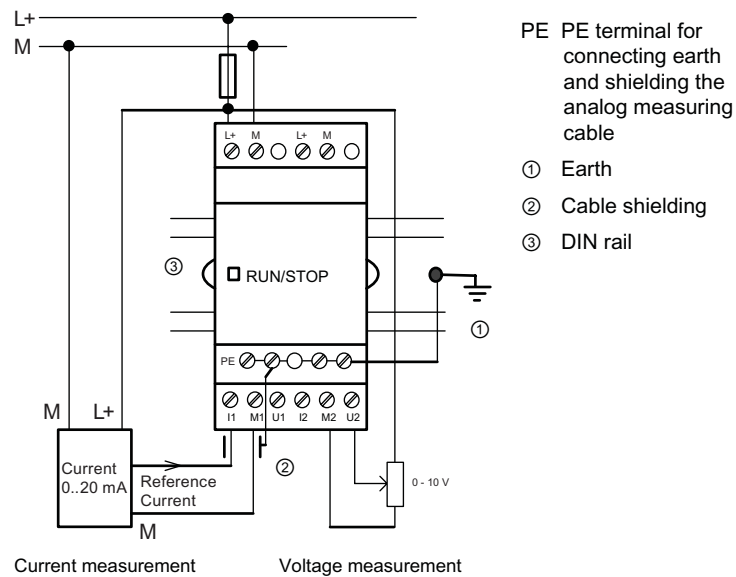

The illustration above shows an example of four-wire current measurement and two-wire voltage measurement.

Connecting a two-wire sensor to the LOGO! AM 2

Wire up the two-wire sensor's connecting wires as follows:

1. Connect the sensor's output to connection U (0 ... 10 V voltage measurement) or to connection I (0 ... 20 mA current measurement) of the AM 2 module.
2. Connect the plus connector on the sensor to the 24 V supply voltage (L+).
3. Connect the ground connection of the current output M (on the right side of the sensor, as shown in the figure above) to the corresponding M input (M1 or M2) on the AM 2 module.

LOGO! AM 2 PT100

You can connect either a 2- or 3-wire PT100 resistive thermocouple to the module.

For a **2-wire** connection, you need to short-circuit terminals M1+ and IC1 or M2+ and IC2. Errors caused by the ohmic resistance of the measuring line are not compensated for this type of connection. A line resistance of 1 Ω is proportional to measuring error of +2.5 °C.

A **3-wire** technique suppresses the influence of the cable length (ohmic resistance) on the result of the measurement.

2-wire technique

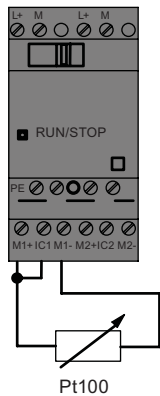

3-wire technique

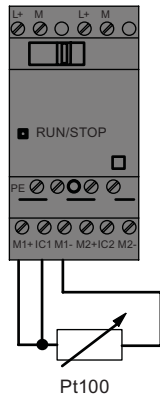

Note

Fluctuating analog values are due to screening on the connecting wire from the analog valuator device to the analog AM 2 / AM 2 PT100 LOGO! expansion module (encoder wire) that has either been mounted incorrectly or not at all.

To avoid fluctuating analog values when using these expansion modules, proceed as follows:

- Use only shielded encoder wires.
- Shorten the encoder wire as much as possible. The encoder wire must not be more than 10 meters long.
- Clamp the encoder wire on one side only and clamp it only to the PE terminal on the AM 2 / AM 2 PT100 / AM 2 AQ expansion module.
- Connect ground on the encoder supply to the PE terminal on the expansion module.
- Avoid operating the LOGO! AM 2 PT100 expansion module with a power supply that is not grounded (potential-free). If you cannot avoid this, connect the negative output/ground output on the power supply to the shielding on the resistance thermometer's measuring wires.

2.3.4 Connecting outputs

LOGO! ...R...

The LOGO! ...R... version is equipped with relay outputs. The potential of the relay contacts is isolated from the power supply and the inputs.

Requirements for relay outputs

You can connect various loads to the outputs; e.g., lamps, fluorescent lamps, motors, contactor relays, etc. For information on the properties required for the loads connected to LOGO! ...R..., refer to the technical data (Page 239).

Connecting

This is how you connect the load to LOGO! ...R... :

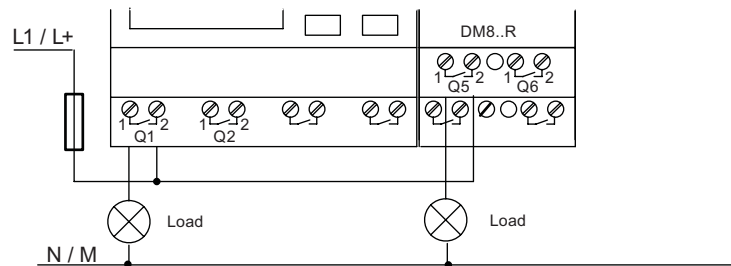

Protection with automatic circuit-breaker, max. 16 A, characteristics B16,
e. g. : Power circuit-breaker 5SX2 116-6 (if required)

LOGO! with solid-state outputs

LOGO! versions with solid-state outputs can be identified by the fact that the letter **R** is missing from their type name. The outputs are short circuit-proof and overload-proof. An auxiliary load voltage supply is not necessary, because LOGO! supplies the load voltage.

Requirements for solid-state outputs

The load connected to LOGO! must have the following characteristics:

- The maximum switched current is 0.3 A per output.

Connecting

This is how you connect the load to a LOGO! with solid-state outputs:

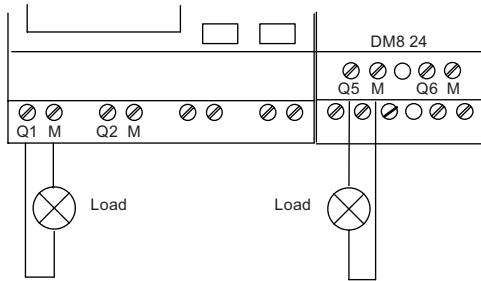

Load: 24 V DC, 0.3 A max.

LOGO! AM2 AQ

LOGO! AM2 AQ

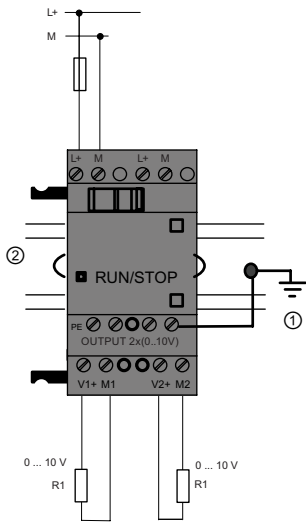

V1, V2: 0 ... 10V DC
R1: >= 5 kΩ

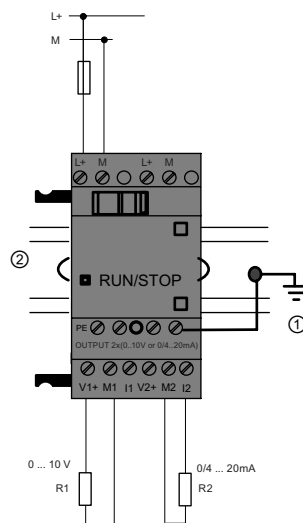

V1, V2: 0 ... 10 V DC
R1: >= 5 kΩ

I1, I2: 0/4 ... 20 mA
R2: <= 250 Ω

- ① Earth
- ② DIN rail

The illustration above shows an example of how to connect the voltage or current load. The differences between both AM2 AQ modules are the order of the output connectors and whether it has 0/4..20mA output function.

2.3.5 Connecting the EIB bus

The connection is carried out via the two-pole screw terminal (+ and -).

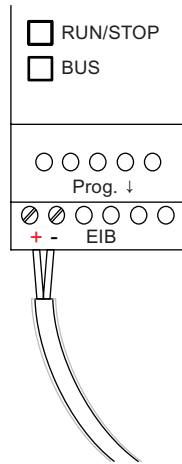

Only the red-black core pair is used, the white-yellow core pair is not connected.

Press the button "Prog ↓" to switch the CM EIB/KNX to programming mode.

Note

The button "Prog ↓" should not be pressed too firmly.

If the bus connection is OK, the LED lights up green.

In programming mode, the LED lights up orange.

Networking on the EIB bus

The CM EIB/KNX takes over the communication between LOGO! and *EIB* and makes communication available via *EIB* inputs/outputs.

The application of the CM EIB/KNX fills the complete LOGO! process image; that is, inputs or outputs which are not occupied on LOGO! can be occupied on the EIB.

Note

For detailed information about the networking of LOGO! on the *EIB* bus please refer to the LOGO! CM EIB/KNX documentation, in particular the Micro Automation Set 8.

2.3.6 Connecting the AS interface bus

To set the address of the module on the AS interface bus, you need an addressing unit. Valid addresses are in the range of 1 to 31. Use each address once only.

You can set the address on the AS interface bus before or after installation. If the installed module is addressed via the address socket, the AS-Interface voltage must be disconnected beforehand. This is necessary for safety reasons.

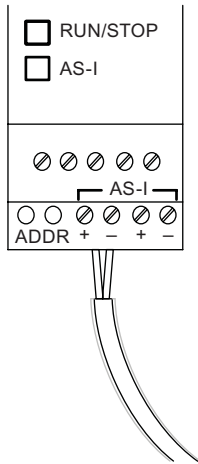

Networking on the AS interface bus

To make the connection to the AS interface bus, you need a communications-capable LOGO! variant:

- LOGO! Basic module + CM AS-I.

To be able to send data across the AS interface bus to LOGO! and to receive data from it in the same way, you also need:

- an AS interface power supply and
- an AS interface master (e.g. an S7-200 with a CP243-2 or a DP/AS-I Link 20 E).

LOGO! can only be accepted as a slave on the AS interface bus. This means that it is not possible to directly exchange data between two LOGO! devices. Data is always exchanged across the AS interface master.

 WARNING
The AS-Interface and LOGO! systems must never be connected together electrically! Use safe isolation according to IEC 61131-2, EN 50178, UL 508, CSA C22.2 No. 42.

Logic Assignments

LOGO! system		AS Interface system
Inputs	←	Output data bits
I _n		D0
I _{n+1}		D1
I _{n+2}		D2
I _{n+3}		D3
Outputs	→	Output data bits
Q _n		D0
Q _{n+1}		D1
Q _{n+2}		D2
Q _{n+3}		D3

"n" depends on the plug-in position of the expansion module relative to the LOGO! Basic. It indicates the number of the input or output in LOGO! program code.

Note

Ensure that there is enough space for the inputs/outputs of the AS interface in the LOGO!'s address space. If you are already using more than 12 physical outputs or more than 20 physical inputs, it is no longer possible to operate the CM AS interface!

For detailed information about the networking of LOGO! on the AS interface bus please refer to the LOGO! CM AS Interface documentation, in particular the Micro Automation Sets 7 and 16.

2.3.7 Connecting modems

The LOGO! 0BA6 device series supports a modem connection between a PC and LOGO! 0BA6 Basic module. You can use modems to download and upload circuit programs between LOGO!Soft Comfort and LOGO! devices. Configuration of the modem connection is only possible with LOGO!Soft Comfort V6.1 or later.

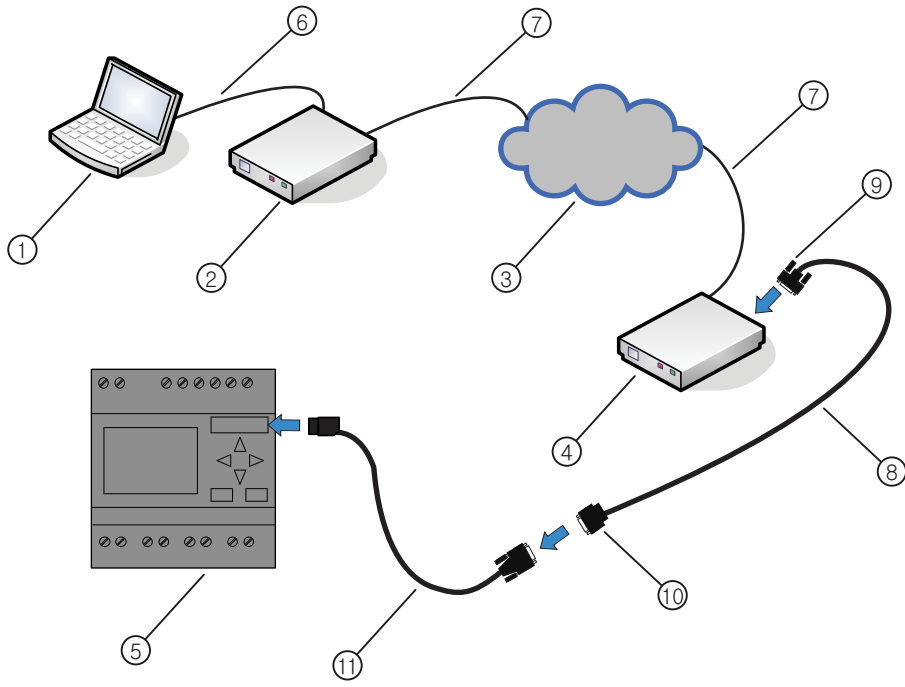

- | | | | |
|---|--|---|--|
| ① | PC (desktop or laptop) | ⑦ | Standard RJ11 telephone line |
| ② | Local modem (Recommended: INSYS Modem) | ⑧ | LOGO! modem cable (length: 0.5 m) |
| ③ | PSTN (Public Switched Telephone Network) | ⑨ | Cable connector, with the visible text "MODEM" on each side |
| ④ | Remote modem (Recommended: INSYS Modem) | ⑩ | Cable connector, with the visible text "PC CABLE" on each side |
| ⑤ | LOGO! Basic module | ⑪ | LOGO! PC cable |
| ⑥ | Standard RS232 cable (9-pin) | | |

For the detailed description of modem configuration, see the LOGO!Soft Comfort V6.1 online help.

For the detailed description of the LOGO! modem cable, see the Product Information supplied with your LOGO! modem cable.

<p>NOTICE</p> <p>The modems used must fulfill the following requirements:</p> <ul style="list-style-type: none">Ability to transmit 11-bit bytes (8 data bits, 1 stop bit, 1 even parity bit)Ability to supply standard AT commands or commands that function as standard AT commands <p>The modem connected with the LOGO! modem cable must be able to supply at least 5 mA current through Pin 1 of its RS232 interface.</p>
--

2.4 Putting into operation

2.4.1 Switching the LOGO!/Power On

LOGO! does not have a power switch. The reaction of LOGO! during startup depends on the following:

- Whether a circuit program is stored in LOGO!
- Whether a memory card or combined memory/battery card is inserted
- Whether this is a LOGO! version without display unit (LOGO!...o)
- The status of LOGO! at the time of power failure.

All possible reactions of LOGO! are described on the following page.

To ensure that the expansion module on LOGO! changes to RUN mode, check the following:

- Has the sliding contact between LOGO! and the expansion module snapped into place properly?
- Is the power supply connected to the expansion module?
- In addition, always ensure that you switch on the power supply to the expansion module first before activating the power supply to the LOGO! Basic module (or activate both power supplies at the same time); if you do not do this, the system does not detect the expansion module when you start up the LOGO! Basic module.

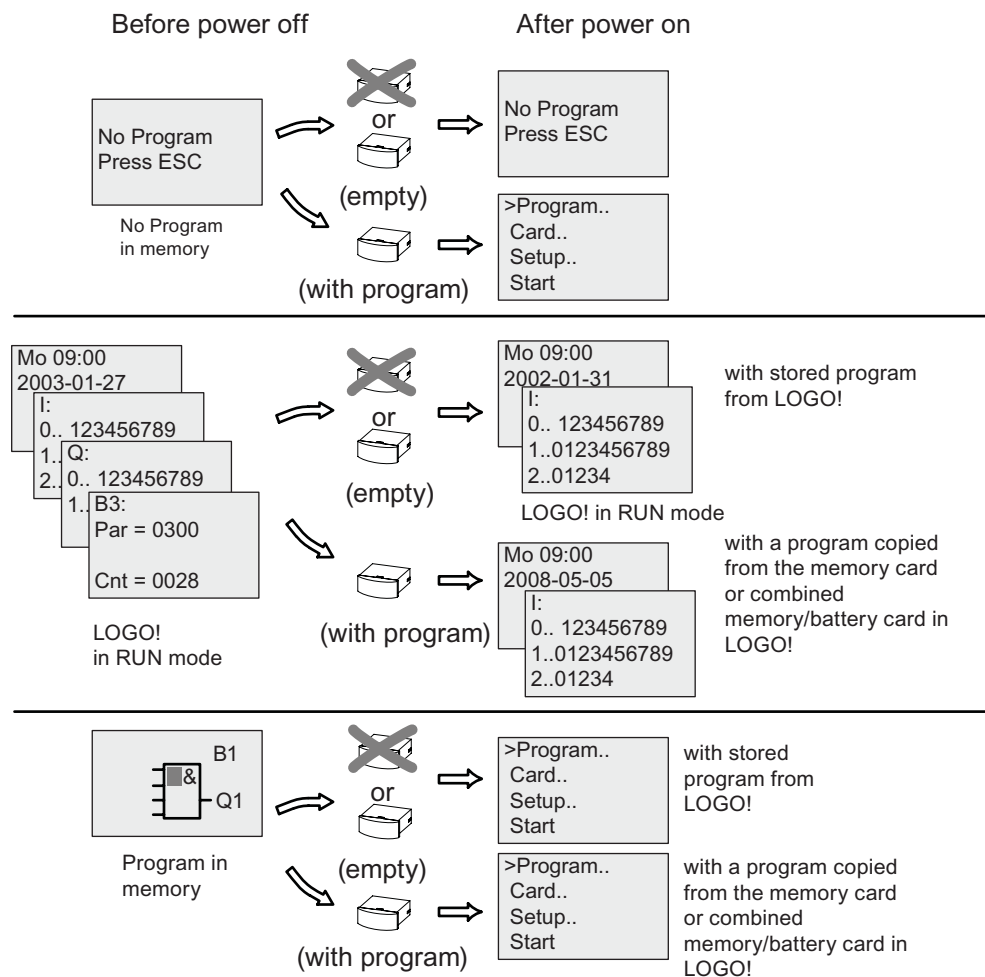

You can also memorize four simple rules for starting LOGO! :

1. If neither LOGO! nor the inserted memory card or combined memory/battery card contains a circuit program, LOGO! (with display unit) reports: 'No Program / Press ESC'.
2. A circuit program on the memory card or combined memory/battery card is automatically copied to LOGO!. The circuit program in LOGO! is overwritten.
3. If there is a circuit program in LOGO! or on the memory card or combined memory/battery card, LOGO! adopts the operational state it had prior to POWER-OFF. Versions without display unit (LOGO!...o) automatically change from STOP to RUN (LED changes from red to green).
4. If you have enabled retentivity for at least one function, or a function is permanently retentive, the current values are retained at POWER-OFF.

Note

When a power failure occurs while you are entering a circuit program, the program in LOGO! will be deleted after power is returned.

Before you modify the circuit program, save a backup copy of your original to a memory card, a combined memory/battery card, or to a computer (using LOGO!Soft Comfort).

2.4.2 Putting a CM EIB/KNX into operation

1. Bus voltage and supply voltage must be present.
2. Connect the PC to the serial EIB interface.
3. Start software ETS, using ETS2 version 1.2.
4. Configure the application program in ETS2, V 1.2.
5. The application program is loaded into the devices via the EIB interface. The application program is available on the LOGO! home page (<http://www.siemens.de/logo>).
6. Click on "Program Physical Address" in ETS.
7. Press the button of the CM EIB/KNX to switch the CM EIB/KNX to programming mode; LED lights up orange.

Note

The button "Prog ↓" should not be pressed too firmly.

If the bus connection is OK, the LED lights up green.

In programming mode, the LED lights up orange.

8. If the LED is extinguished, the programming of the physical address has finished. You can now mark the physical address on the device. Composition of the physical address: Area / Line / Device XX / XX / XXX
9. The application program can now be run. The device is then ready for operation.
10. If several CM EIB/KNX are installed in an EIB system, steps 1 to 9 must be repeated for each CM EIB/KNX.
11. Any further details about EIB commissioning can be found in the corresponding documentation.

2.4.3 Operating states

LOGO! Basic operating states

LOGO! Basic/Pure has two operating states: STOP and RUN.

STOP	RUN
<ul style="list-style-type: none"> • The display shows: 'No Program' (not LOGO!...o) • Switching LOGO! to programming mode (not LOGO!...o) • LED is red (only LOGO!...o) 	<ul style="list-style-type: none"> • Display: Screen mask for monitoring I/Os and messages (after START in the main menu) (not LOGO!...o) • Switching LOGO! to parameter assignment mode (not LOGO!...o) • LED is green (only LOGO!...o)
<p>Action of LOGO!:</p> <ul style="list-style-type: none"> • The input data is not read. • The circuit program is not executed. • The relay contacts are permanently open or the solid-state outputs are switched off. 	<p>Action of LOGO!:</p> <ul style="list-style-type: none"> • LOGO! reads the status of the inputs. • LOGO! uses the circuit program to calculate the status of the outputs. • LOGO! switches the relay/solid-state outputs on or off.

Note

After switching the power on, the system briefly switches through the outputs on the LOGO 24/24o. With an open circuit, a voltage of > 8 V can occur for up to approximately 100 ms; when loaded, this time reduces to a matter of microseconds.

LOGO! expansion modules, operating states

LOGO! expansion modules have three operating states: The LED (RUN/STOP) is lit green, red or orange.

LED (RUN/STOP) is lit		
Green (RUN)	Red (STOP)	Orange/Yellow
The expansion module communicates with the device to the left.	The expansion module does not communicate with the device to its left.	Initialization phase of the expansion module

CM AS Interface, communication states

The CM AS Interface has three communication states: The LED is lit green, red or flashes red/yellow.

LED AS-I is lit		
Green	Red	Red/Yellow
AS Interface communication OK	AS Interface communication failed	Slave has address "0".

CM AS Interface, behavior on communication failure

- If the AS Interface voltage fails, communication between the LOGO! system and the expansion modules, which are arranged to the right of the LOGO! CM AS Interface expansion module, is interrupted.
Recommendation: Position LOGO! CM AS Interface on the far right side.
- If communication is interrupted, the switching outputs are reset after about 40 to 100 ms.

CM EIB/KNX, communication states

The CM EIB/KNX has three communication states: The LED is lit green, red or orange.

LED BUS is lit		
Green	Red	Orange
Bus connection OK, communication OK, no programming mode	Bus connection interrupted	Programming mode active and bus connection OK

CM EIB/KNX, behavior on communication failure

- LOGO! voltage failure
If there is a power failure of LOGO! or a disruption in the communication to the LOGO! master or to the communication partner on the left side, the outputs are set to 0. The RUN/STOP LED lights up red after a second.
- LOGO! voltage recovery
LOGO! starts up again, CM EIB/KNX sends the parameterized states.
- CM EIB/KNX voltage failure
All the inputs of the LOGO! master on the *EIB* are set to 0 by the LOGO! master.
- CM EIB/KNX voltage recovery
All the outputs of the LOGO! master on the *EIB* are updated. The inputs are read by the *EIB* depending on the parameterization.
- Short circuit on the bus or bus interruption
The behavior can be parameterized in the LOGO! configuration window of the application program in ETS (EIB Tool Software). The red light is set after 5 seconds.
- Bus recovery
The behavior can be parameterized in the LOGO! configuration window.

Programming LOGO!

Getting started with LOGO!

Programming refers to creating a circuit program from the LOGO! Basic module.

In this chapter you will learn how to use LOGO! to create the LOGO! circuit programs for your application.

LOGO!Soft Comfort is the LOGO! programming software that you can use on your PC to quickly and easily create, test, modify, save and print the circuit programs. The topics in this manual, however, relate only to the creation of circuit programs on the actual LOGO! Basic module. The programming software LOGO!Soft Comfort contains extensive online help.

Note

LOGO! versions without a display unit; that is, the LOGO! 24o, LOGO! 12/24RCo, LOGO! 24RCo and LOGO! 230RCo versions, do not have an operator panel and display unit. They are primarily designed for use in small machine and process equipment engineering systems for series production.

LOGO!...o versions are not programmed directly on the device. Instead, the circuit program is downloaded to the device from LOGO!Soft Comfort or from memory cards or combined memory/battery cards from other LOGO! devices.

LOGO! versions without a display cannot write data to memory cards or combined memory/battery cards.

See the chapters "LOGO! memory and battery cards (Page 223)", "", and the appendix "LOGO! without display (Page 269)" for more information.

A small example in the first part of this chapter introduces the operating principles of LOGO!:

- You will learn the meaning of two basic terms, namely the **connector** and the **block**.
- As the next step, you will create a circuit program based on a simple conventional circuit.
- Lastly, you will enter this program directly in LOGO!

It will take you only a few pages of this manual to store your first executable circuit program in the LOGO! unit. With suitable hardware (switches etc.), you will then be able to carry out initial tests.

3.1 Connectors

LOGO! is equipped with inputs and outputs

Example of a configuration with several modules:

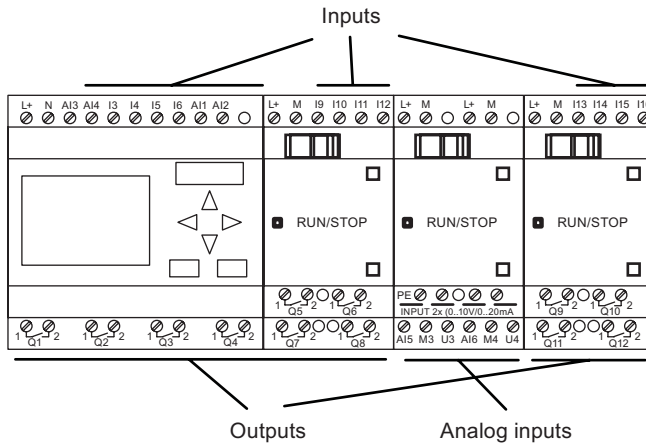

Each input is identified by the letter I plus a number. When you look at LOGO! from the front, you can see the input terminals at the top. Only analog modules LOGO! AM 2 and AM 2 PT100 have the inputs at the bottom.

Each output is identified by the letter Q plus a number (AM 2 AQ: AQ plus number). In the figure, you can see the output terminals at the bottom.

Note

LOGO! can recognize, read and switch the I/O of all expansion modules regardless of their type. The I/Os are presented in the installation order of the modules.

The following I/Os and flag blocks are available for creating your circuit program: I1 to I24, AI1 to AI8, Q1 to Q16, AQ1 and AQ2, M1 to M27, and AM1 to AM6. Also available are the shift register bits S1 to S8, 4 cursor keys: C ▲, C ►, C ▼ and C ◀, four function keys on the LOGO! TD: F2, F2, F3, and F4 as well as 16 blank outputs X1 to X16. See the "Constants and connectors (Page 102)" topic for more details.

The following applies to inputs I1, I2, I7 and I8 of LOGO! 12/24.. and LOGO! 24/24o versions: If you use I1, I2, I7 or I8 in the circuit program, this input signal is digital. If you use AI3, AI4, AI1, or AI2, the input signal is analog. The numbering of the analog inputs is significant: AI1 and AI2 corresponded to I7 and I8 on the OBA5 module. With the addition of two new analog inputs for the OBA6 series, these modules optionally use I1 for AI3 and I2 for AI4. See the graphical representation in the topic on "Maximum setup (Page 26)". Also note that you can also use I3, I4, I5, and I6 as fast digital inputs.

The illustration above with numbered AI inputs shows the conceptual usage of the inputs, not the actual physical markings on the module.

LOGO!'s connectors

The term connector refers to all connections and states in LOGO! .

The digital I/O status can be '0' or '1'. Status '0' means that the input does not carry a specific voltage. Status '1' means that the input does carry a specific voltage.

The 'hi', 'lo' and 'x' connectors have been introduced to make it easier for you to create the circuit program:





'hi' (high) is assigned the status '1',

'lo' (low) is assigned the status '0'.

You do not have to use all of the connectors of a block. The circuit program automatically assigns the unused connectors a status that ensures proper functioning of the relevant block. If you prefer to do so, you can identify unused connectors with an 'x'.

For information on the meaning of the term "block", refer to the topic on "Blocks and block numbers (Page 57)".

LOGO! has the following connectors:

Connectors	LOGO! Basic / Pure		DM	AM	AM2AQ
					
Inputs	LOGO! 230RC/RCo, LOGO! 24 RC/RCo	Two groups: I1...I4 and I5...I8	I9...I24	A1...A18	none
	LOGO! 12/24RC/RCo, LOGO! 24/24o	I1,I2, I3-I6, I7, I8 AI3,AI4...AI1, AI2	I9 ... I24	A15...A18	
Outputs	Q1...Q4		Q5...Q16	none	AQ1, AQ2
lo	Logical '0' signals (off)				
hi	Logical '1' signals (on)				
x	An existing connection that is not used				

DM: Digital module

AM: Analog module

3.2 EIB inputs/outputs

The application program "20 CO LOGO! 900E02" controls the communication between the LOGO! and the EIB/KNX bus via the communication module CM EIB/KNX.

By configuring the application program in ETS (EIB Tool Software), the division of the input and output area of the LOGO! can be defined as a "hardware channel" and as a "virtual channel" on the EIB/KNX bus.

This characteristic also applies for analog processing.

A communication object is assigned to each "hardware channel" and each "virtual channel" of LOGO! module.

The real-time clock of LOGO! can be used as a master or slave via the EIB/KNX bus.

The behavior of the communication objects of the communication module CM EIB/KNX, when the status of the EIB/KNX bus changes, can also be parameterised.

A "virtual input channel" can be used as a bus state; that is, a bus voltage failure can be reported.

The settings for analog values in LOGO! (Offset, Gain) do not affect the analog values for the CM EIB/KNX communication module (the output values of the CM EIB/KNX are always the raw values between 0 and 1000). In this case, you must parameterize customizing in the ETS.

Functions of the application program

- Specification of the hardware configuration (number of local digital inputs and outputs, analog inputs)
- Selection of time master or slave
- Use of I24 as a bus status signal
- Behavior on bus voltage failure/recovery
- Input type as monoflop/normal for digital inputs via the EIB/KNX
- Output type as normal/dimmer/edge evaluation for digital outputs via the EIB/KNX
- Data type, adaptation, cyclical sending and sending on change in value for analog outputs via the EIB/KNX and analog inputs on LOGO!

Any further details about configuring the application program in ETS can be found in the current application program description.

For the application program see Siemens product database from version J onwards:

- <http://www.siemens.de/gamma>
- <http://www.siemens.de/logo>

3.3 Blocks and block numbers

This chapter shows you how to use LOGO! elements to create complex circuits and how blocks and I/O are interconnected.

In the topic "From circuit diagram to LOGO! Program (Page 60)" you will learn how to transform a conventional circuit into a LOGO! circuit program.

Blocks

A block in LOGO! represents a function that is used to convert input information into output information. Previously you had to wire the individual elements in a control cabinet or terminal box.

When you create the circuit program, you interconnect the blocks. To do so, simply select the connection you require from the **Co** menu. The menu name Co is an abbreviation of the term "Connector".

Logic operations

The most elementary blocks are the logic operations:

- AND
- OR
- ...

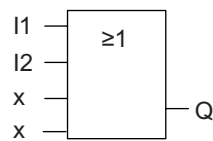

Inputs I1 and I2 are here connected to the OR block. The last two inputs of the block remain unused and are identified by the creator of the circuit program with an 'x'.

These special functions offer you significantly greater performance:

- Pulse relay
- Up/down counter
- On-delay
- Softkey
-

The chapter entitled "LOGO! functions (Page 101)" gives a full list of the LOGO! functions.

Block representation on the LOGO! Display

The figure below shows a typical view of the LOGO! Display. As you can see, it can show only one block at a time. We have therefore introduced block numbers to help you check the circuit structure.

View of the LOGO! display

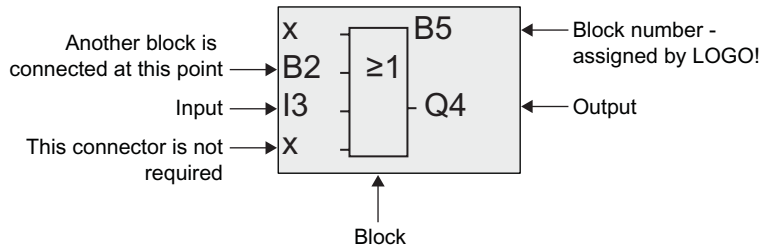

Assigning a block number

LOGO! assigns each new block in a circuit program a block number.

LOGO! uses these block numbers to indicate the block interconnections. This means that these numbers are mainly an aid to your orientation in the circuit program.

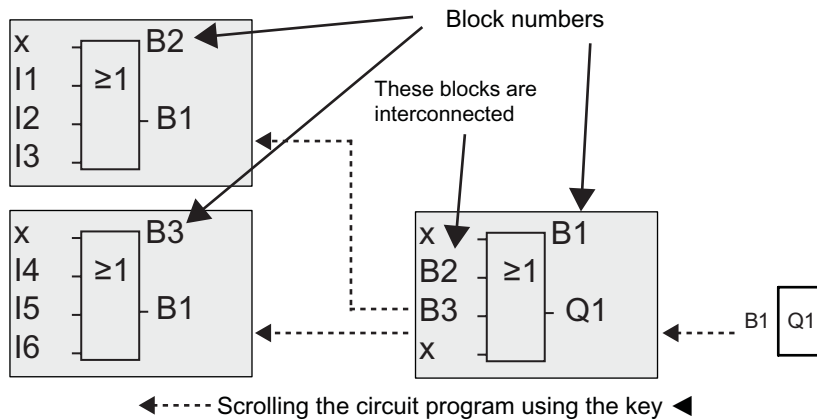

The figure above shows you three views of the LOGO! Display, which represent the circuit program. As you can see, LOGO! interconnects the blocks using their numbers.

Advantages of block numbers

You can connect almost any block to an input of the current block by means of its block number. In this way, you can reuse the interim results of logical or other operations, reduce programming effort, save memory space and clean up your circuit layout. To do so, however, you need to know how LOGO! has named the blocks.

Note

We advise you to create an organizational program chart. You will find this a valuable aid when you create the circuit program because you can enter in this chart all the block numbers that LOGO! assigns.

By using the LOGO!Soft Comfort software to program LOGO!, you can directly create a function chart of your circuit program. LOGO!Soft Comfort also allows you to assign eight-character names to up to 100 blocks, and to view these on the LOGO! Display in parameter assignment mode. See the topic "The four golden rules for operating LOGO! (Page 63)".

3.4 From circuit diagram to LOGO! program

View of a circuit diagram

You know, of course, how a circuit logic is represented in a circuit diagram. Nevertheless, here is an example:

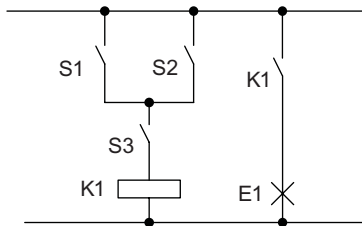

Load E1 is switched on and off by means of the switches (S1 OR S2) AND S3.

Relay K1 picks up when condition (S1 OR S2) AND S3 is met.

Creating this circuit with LOGO!

In LOGO! you create a circuit logic by interconnecting blocks and connectors:

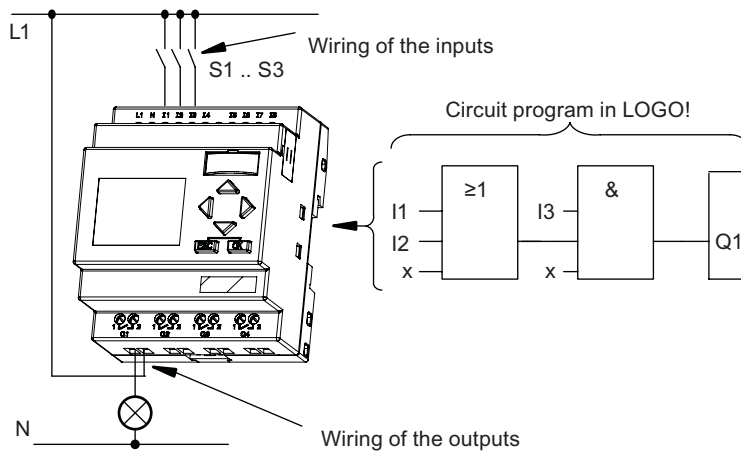

Note

Although you have four inputs available for logic operations (Page 105), most of the views will only show three inputs for reasons of clarity. You program this fourth input and assign parameters just like you do with the other three inputs.

To create a circuit logic in LOGO!, start at the circuit output.

The output is the load or relay that is to be switched.

Convert the circuit logic into blocks by working through the circuit, starting at the output and ending at the input:

Step 1: The make contact S3 is interconnected in series to output Q1 and to a further circuit element. A series connection corresponds with the AND block:

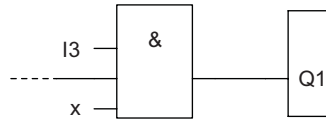

Step 2: S1 and S2 are connected in parallel. A parallel circuit corresponds with the OR block:

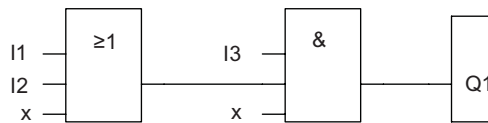

Unused inputs

The circuit program automatically assigns the unused connectors a status that ensures proper functioning of the relevant block. If you like, you can label unused connectors with an 'x' identifier.

In our example we shall use only two inputs of the OR block and two inputs of the AND block; the relevant unused third and fourth inputs are identified at the connector with an 'x'.

Now connect the I/Os to LOGO! .

Wiring

Connect the switches S1 to S3 to the screw terminals of your LOGO! :

- S1 to connector I1 of LOGO!
- S2 to connector I2 of LOGO!
- S3 to connector I3 of LOGO!

The output of the AND block controls the relay at output Q1. The load E1 is connected to output Q1.

Wiring example

The following figure shows you the wiring, based on a 230 V AC version of LOGO!.

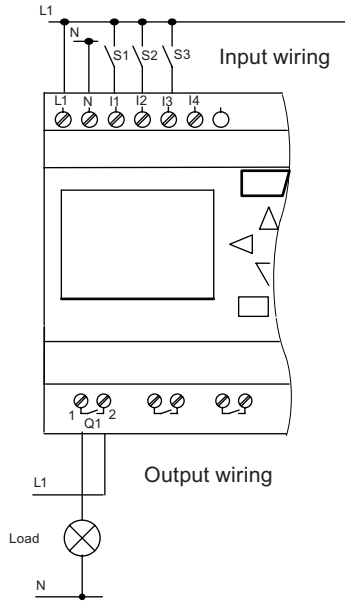

3.5 The four golden rules for operating LOGO!

Rule 1: Changing the operating mode

- You create the circuit program in programming mode. After power is on, and when the display shows "No Program / Press ESC", press the **ESC** key to select programming mode.
- Timer and parameter values of an existing circuit program can be edited both in **parameter assignment mode** and in **programming mode**. During **parameter assignment** LOGO! is in **RUN mode**; that is, it continues executing the circuit program (see the topic "Configuring LOGO! (Page 211)"). To work in **programming mode**, you need to terminate the circuit program by calling the **"Stop"** command.
- Select the 'Start' command on the main menu to set **RUN mode**.
- When the system is in **RUN**, you can return to **parameter assignment mode** by pressing the **ESC** key.
- When **parameter assignment mode** is open and you want to return to **programming mode**, select the **"Stop"** command from the parameter assignment menu, and confirm **"Stop Prg"** prompt with **"Yes"**. To do so, move the cursor to **"Yes"** and confirm with OK.

For more details on operating modes, refer to the Appendix topic "LOGO! Menu structure (Page 271)".

Note

The following applies to 0BA2 device versions and earlier:

- You can open programming mode by pressing **◀▶+OK**.
 - You set parameter assignment mode by pressing **ESC+OK**.
-

Rule 2: Outputs and inputs

- Always create your circuit program by working from the output to the input.
- You can connect an output to several inputs, but not the same input to several outputs.
- Within the same program path you may not connect an output to an upstream input. For such internal recursions you should interconnect flags or outputs.

Rule 3: Cursor and cursor movement

The following applies when you edit a circuit program:

- You can move the cursor when it appears in the form of an underscore:
 - Press ◀, ▶, ▼ or ▲ to move the cursor in the circuit program.
 - Press **OK** to change to "Select connector/block".
 - Press **ESC** to exit programming mode.
- You select a connector/block - when the cursor appears as a solid square:
 - Press ▼ or ▲ to select a connector or a block.
 - Confirm with **OK**.
 - Press **ESC** to return to the previous step.

Rule 4: Planning

- Before you start to create a circuit program, you should either first create a design on paper or program LOGO! directly using LOGO!Soft Comfort.
- LOGO! can only save complete and faultless circuit programs.

3.6 Overview of LOGO! menus

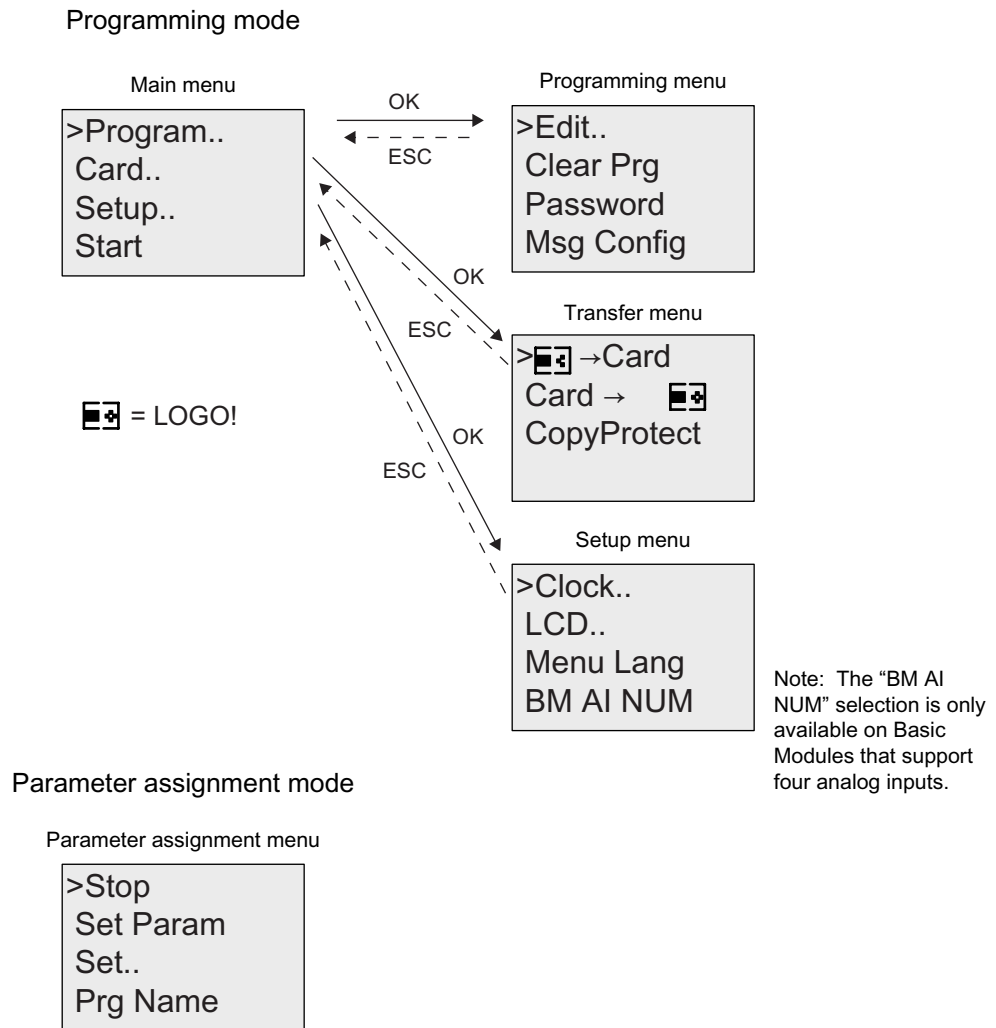

For more details on these menus, refer to the Appendix topic entitled "LOGO! menu structure (Page 271)".

The LOGO! TD menus provide configuration settings (Page 275) for the LOGO! TD. These menus are a subset of the LOGO! menus and are operated in much the same way.

3.7 Writing and starting the circuit program

After you have designed a circuit, you want to write it to your LOGO!. The small example below shows how to do this.

3.7.1 Selecting programming mode

You have connected LOGO! to the power supply and switched it on. The display now shows you the message:

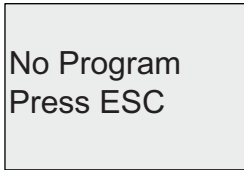

Switch LOGO! to programming mode by pressing **ESC**. This will take you to the main menu of LOGO!:

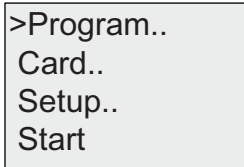

LOGO! main menu

The first character in the first line is the ">" cursor. Press **▲** and **▼** to move the ">" cursor up and down. Move it to "Program.." and confirm with **OK**. LOGO! opens the programming menu.

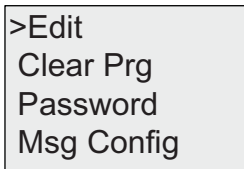

LOGO!'s programming menu

Here you can also move the ">" cursor by pressing **▲** and **▼**. Move the ">" cursor to "Edit.." and confirm with **OK**.

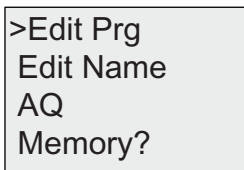

The Edit menu of LOGO!

Move the ">" cursor to "Edit Prg" (for editing the circuit program) and confirm with **OK**. LOGO! now shows you the first output:

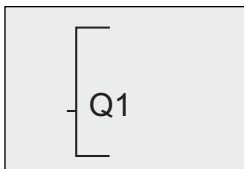

The first output of LOGO!

You are now in programming mode. Press **▲** and **▼** to select the other outputs. Now start to edit your circuit program.

Note

Because we have not yet saved a **password** for the circuit program in LOGO!, you can directly enter editing mode. When you select "Edit" after you have saved a password-protected circuit program, you are prompted to enter a password and to confirm it with **OK**. You can only edit the program after you have entered the correct password (Page 74).

3.7.2 The first circuit program

Let us now take a look at the following parallel circuit consisting of two switches.

Circuit diagram

The corresponding circuit diagram:

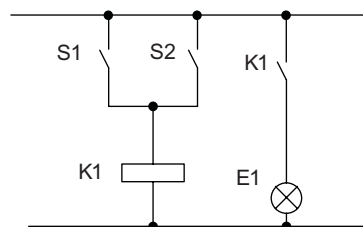

The load is switched on with S1 OR S2. LOGO! interprets this parallel circuit as an 'OR' logic, because S1 OR S2 switches on the output.

Translated into a LOGO! circuit program this means: Relay K1 is (at output Q1) is controlled by means of an OR block.

Circuit program

S1 is connected to the I1 and S2 to the I2 input connector of the OR block.

The corresponding layout of the circuit program in LOGO!:

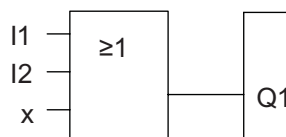

Wiring

The corresponding wiring:

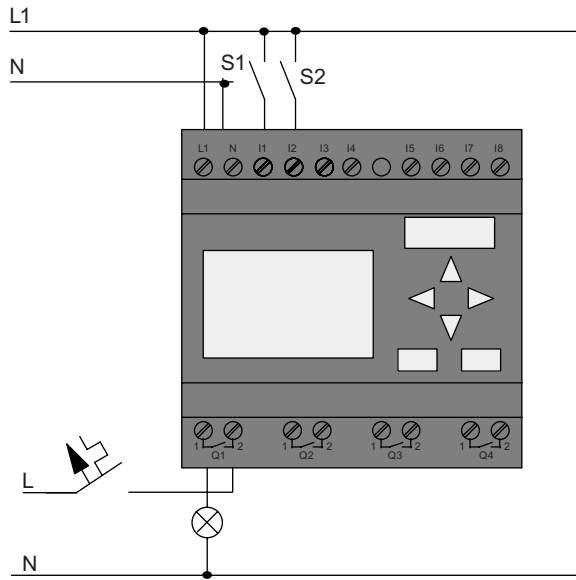

S1 switches input I1, while S2 switches input I2. The load is connected to the relay Q1.

3.7.3 Circuit program input

Let us now write the circuit program, starting at the output and working towards the input. LOGO! initially shows the output:

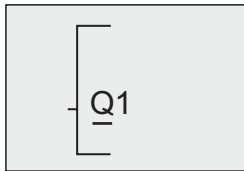

The first LOGO! output

You will see an underscore below the Q in Q1, which is the **cursor**. The cursor indicates your current position in the circuit program. You can move the cursor by pressing the **▲**, **▼**, **◀** and **▶** keys. Now press the **◀** key. The cursor moves to the left.

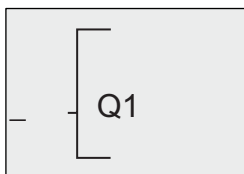

The cursor indicates your current position in the circuit program.

At this point you enter only the first (OR) block. Press **OK** to select editing mode.

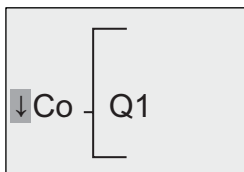

The cursor is displayed as a solid square: You can now select a connector or a block

The cursor no longer appears in the form of an underscore; but instead as a flashing solid square. LOGO! offers you various options here.

Select GF (basic functions) by pressing the **▼** key until GF appears, and confirm with **OK**. LOGO! now shows the first block from the list of basic functions:

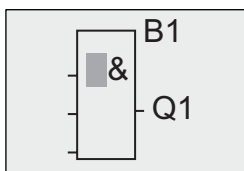

The AND is the first block of the basic functions list. The solid square cursor prompts you to select a block.

Now press **▼** or **▲** until the OR block appears on the display:

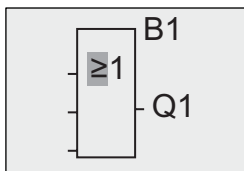

The solid square cursor is still positioned on the block.

Press **OK** to confirm your entries and exit the dialog.

The display now shows:

Your complete circuit program layout

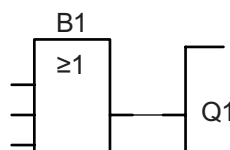
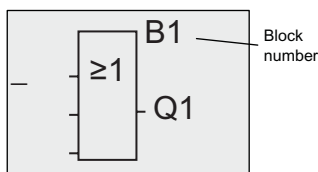

You have now entered the first block. Each new block is automatically assigned a block number. The only thing left to do is interconnect the block inputs. This is how it is done:

Press **OK**.

The display now shows:

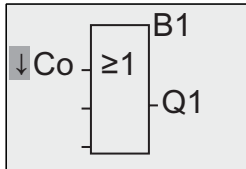

Select the **Co** list: Press **OK**

The display now shows:

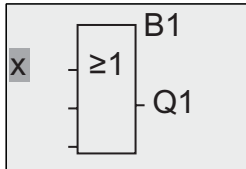

The first element of the **Co** list is the "Input 1" character, namely "I1".

Note

Press ▼ to go to the start of the Co list: I1, I2 ... to I0. Press ▲ to go to the end of the Co list: I0, I1, ... to I1.

Inputs F1, F2, F3, and F4 are new as of the 0BA6 device series. They correspond to the four function keys on the optional LOGO! TD.

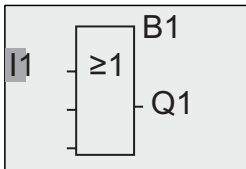

Press **OK**. I1 is now connected to the input of the OR block. The cursor jumps to the next input of the OR block.

The display now shows:

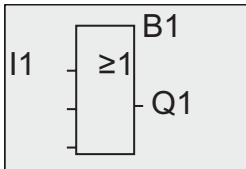

Your complete circuit program in LOGO! up to now:

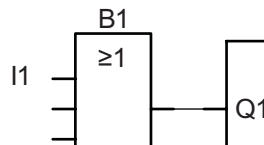

Now you connect input I2 to the input of the OR block:

1. Switch to editing mode: Press **OK**
2. Select the **Co** list: Press **▼** or **▲**
3. Confirm the Co list with: Press **OK**
4. Select **I2**: Press **▼** or **▲**
5. Apply I2: Press **OK**

I2 is now connected to the input of the OR block:

The display now shows:

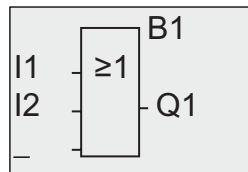

Your complete circuit program in LOGO! up to now:

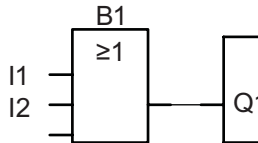

We do not need the last two inputs of the OR block for this circuit program. You can mark the unused inputs with an 'x'. Enter the 'x' character twice:

1. Switch to editing mode: Press **OK**
2. Select the **Co** list: Press **▼** or **▲**
3. Accept the Co list: Press **OK**
4. Select **'x'**: Press **▼** or **▲**
5. Apply x: Press **OK**

The display now shows:

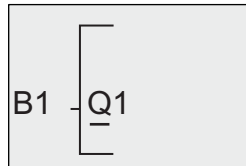

This is the layout of your circuit program:

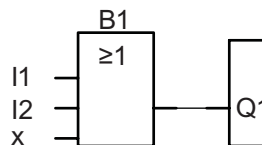

Note

You can invert individual inputs of the basic and special functions; that is, if an input carries a logical "1" signal, the circuit program will output a logical "0". On the other hand, a logical "0" is inverted into a logical "1" signal.

To invert an input, move the cursor to the relevant position, e.g.:

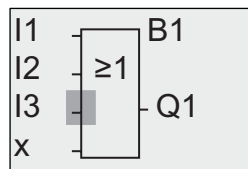

Confirm with **OK**.

Now press **▲** or **▼** to invert this input:

Next, press **ESC**.

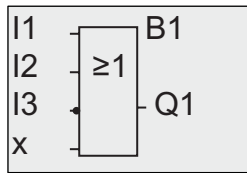

Your circuit program layout:

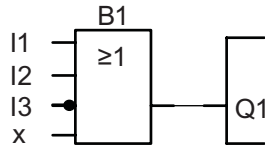

You can review your first circuit program by pressing ◀ or ▶ to move the cursor through the circuit program.

We shall now exit circuit programming mode. To return to the programming menu: Press **ESC**

Note

LOGO! has now saved your circuit program to nonvolatile memory. The circuit program remains in the LOGO! memory until you explicitly delete it.

You can save the actual values of special functions in the case of a power outage assuming that these functions support the "Retentive" parameter and that the necessary program memory is available. The Retentive parameter is deactivated when you insert a function; to use it, you must enable this option.

3.7.4 Assigning a circuit program name

You can assign your circuit program a name that consists of up to 16 uppercase/lowercase letters, numbers and special characters.

In the programming menu:

1. Move the ">" cursor to 'Edit.': Press ▼ or ▲
2. Accept 'Edit': Press OK
3. Move the ">" cursor to 'Edit Name': Press ▼ or ▲
4. Accept 'Edit Name': Press OK

Press ▲ and ▼ to list the alphabet, numbers and special characters, either in ascending or descending order. You can select any letter, number or character.

To enter a space character, simply move the cursor with ► to the next position. This character is the first one in the list.

Examples:

Press ▼ once to select an " A "
▲ four times to select " { ", etc.

The following character set is available:

	A	B	C	D	E	F	G	H	I	J	K	L	M	N	O
P	Q	R	S	T	U	V	W	X	Y	Z	a	b	c	d	e
f	g	h	i	j	k	l	m	n	o	p	q	r	s	t	u
v	w	x	y	z	0	1	2	3	4	5	6	7	8	9	!
"	#	\$	%	&	'	()	*	+	,	-	.	/	:	;
<	=	>	?	@	[\]	^	_	'	{		}	~	

Let us assume you want to name your circuit program "ABC":

1. Select " A ": Press ▼
2. Move to the next letter: Press ►
3. Select " B ": Press ▼
4. Move to the next letter: Press ►
5. Select " C ": Press ▼
6. Confirm the complete name: Press OK

Your circuit program is now named "ABC", and you are returned to the programming menu.

To **change** the name of your circuit program, proceed in the same way.

Note

You can change the name of the circuit program only in programming mode. You can **read** the name both in programming **and** in parameter assignment mode.

3.7.5 Password

You can protect a circuit program from unauthorized access by assigning it a password.

You can only assign or deactivate a password from the LOGO! Basic module or from LOGO!Soft Comfort. You can only change a password from the LOGO! Basic module. If you have assigned a password, and are using a LOGO! TD (version ES4 or later) together with a LOGO! Basic module (version ES4 or later), you must enter this password if you want to change LOGO! from RUN mode to STOP mode from the LOGO! TD. You can not stop the execution of the circuit program in LOGO! from the LOGO! TD without entering the password.

Note

This password protection function is only available in the LOGO! TD with version number ES4 or later. This function is **only available** under the following conditions:

- The version number of both the LOGO! Basic and the LOGO! TD installed is at least ES4
- LOGO! is currently in RUN mode and you want to switch to STOP mode

There is only one password that you can assign for LOGO!. You can only assign it from the LOGO! Basic module or from LOGO!Soft Comfort. To change LOGO! from RUN to STOP from the LOGO! TD, you must enter the password from the LOGO! TD as described below in the section "Changing LOGO! from RUN to STOP mode from the LOGO! TD".

Assigning a password from the LOGO! Basic module

A password can have a maximum length of 10 characters, and consists only of uppercase letters. On the LOGO! Basic module, you can assign, edit or deactivate the password only from the "Password" menu.

To enter a password, follow these steps in the programming menu:

1. Move the ">" cursor to '**Password**': Press ▼ or ▲
2. Confirm the '**Password**': Press **OK**

Press ▼ or ▲ to move up and down the alphabet to select your letters. Because the LOGO! Basic module only provides uppercase letters for the password, you can quickly access letters "at the end" of the alphabet (in this example, English) by using the ▲ button:

Press ▲ once to select "**Z**"

Press ▲ twice to select "**Y**", etc.

The display appears as follows:

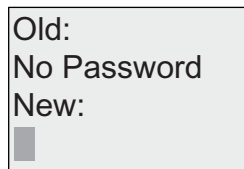

To enter a password of "**AA**", for example, the procedure is the same as for entering the name of the circuit program. Select "New" and enter:

3. Select "**A**": Press ▼
4. Move to the next letter: Press ►
5. Select "**A**": Press ▼

The display now appears as follows:

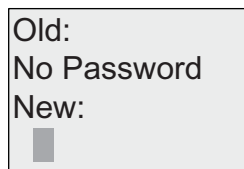

6. Confirm the password: Press **OK**

Your circuit program is now protected with the password "**AA**", and you are returned to the programming menu.

Note

You can cancel the input of a new password with **ESC**. In this case, the LOGO! Basic module returns to the programming menu without saving the password.

You can also set your password using LOGO!Soft Comfort. You cannot edit a password-protected circuit program in a LOGO! Basic module or upload it to LOGO!Soft Comfort unless you enter the correct password.

To allow you to create and edit a circuit program for a protected module (Card), you first need to assign a password to this new program (Page 225).

Changing the password from the LOGO! Basic module

You must know the current password in order to change it. From the programming menu, follow these steps to change the password:

1. Move the '>' cursor to **'Password'**: Press ▼ or ▲
2. Confirm the 'Password': Press **OK**

Select "Old" and enter your old password (in our case: **'AA'**) by repeating steps 3 through 6 as described earlier.

The display now shows:

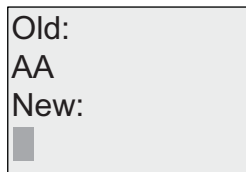

Now you can select "New" to enter the new password, e.g. **"ZZ"**:

3. Select **"Z"**: Press ▲
4. Move to the next letter: Press ►
5. Select **"Z"**: Press ▲

The display now shows:

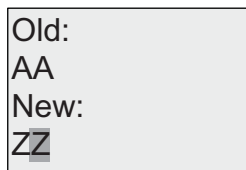

6. Confirm your new password: Press **OK**

Your new password **"ZZ"** is now set, and you are returned to the programming menu.

Deactivating the password from the LOGO! Basic module

To deactivate the password to allow, for example, another user to edit your circuit program, you must know your current password (in our example "ZZ"), the same as if you were changing it.

To deactivate the password, following these steps in the programming menu:

1. Move the '>' cursor to **Password**: Press ▼ or ▲
2. Confirm the 'Password': Press **OK**

Select "Old" and enter your current password as described in steps 3 to 5. Confirm your entries with OK.

The display shows:

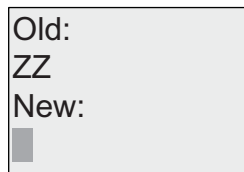

```
Old:
ZZ
New:
█
```

Clear the password by leaving the input box **blank**:

3. Confirm the "blank" password: Press **OK**

The password is "cleared", and LOGO! returns to the programming menu.

Note

This action disables the password prompt, and thus permits access without a password.

Leave the password **deactivated** for quicker progress through the remaining exercises and examples.

Password: Wrong Password!

If you enter the **wrong** password and confirm the input with **OK**, the LOGO! Basic module does not open editing mode, but returns to the programming menu. This repeats itself over and over again until you enter the correct password.

Changing LOGO! from RUN to STOP mode from the LOGO! TD

A change from RUN mode to STOP mode from the LOGO! TD requires password entry if one is assigned. You must know the existing password if one is assigned. If there is no password assigned on the LOGO! Basic module, the LOGO! TD will not prompt you for password entry.

To change LOGO! from RUN mode to STOP mode from the LOGO! TD when LOGO! is password-protected, follow these steps:

1. On the LOGO! TD, press **ESC** to switch LOGO! from RUN mode to STOP mode. LOGO! TD shows the following menu:



2. Press **OK**. The LOGO! TD shows you the following display:

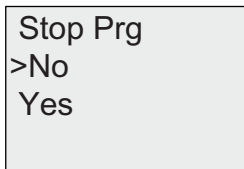

3. Press **▼** to move the cursor to "Yes", and press **OK**. Enter the correct password (in this case: "ZZ"). If you enter an incorrect password, the LOGO! TD returns to the display in Step 1.

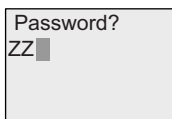

4. Press **OK** to exit the password entry screen form. The LOGO! TD opens the main menu:

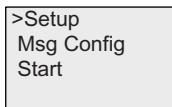

LOGO! changes to STOP mode.

Note

Whenever the LOGO! TD is shut down, the password is reset. The next time you start it and access this password-protected function (RUN to STOP), you will be prompted for password entry on the LOGO! TD.

When LOGO! subsequently changes from STOP to RUN mode, you will again be prompted for password entry to change LOGO! to STOP mode from the LOGO! TD if more than one minute has elapsed since you pressed any key on the LOGO! TD.

The LOGO! TD can also change LOGO! from STOP to RUN mode, but no password is required in this case.

3.7.6 Switching LOGO! to RUN mode

In the main menu, select RUN to start LOGO!.

1. Return to the main menu: Press **ESC**
2. Move the '>' cursor to '**Start**': Press **▲** or **▼**
3. Confirm '**Start**': Press **OK**

LOGO! runs the circuit program and shows the following display:

Display field of LOGO! in RUN mode

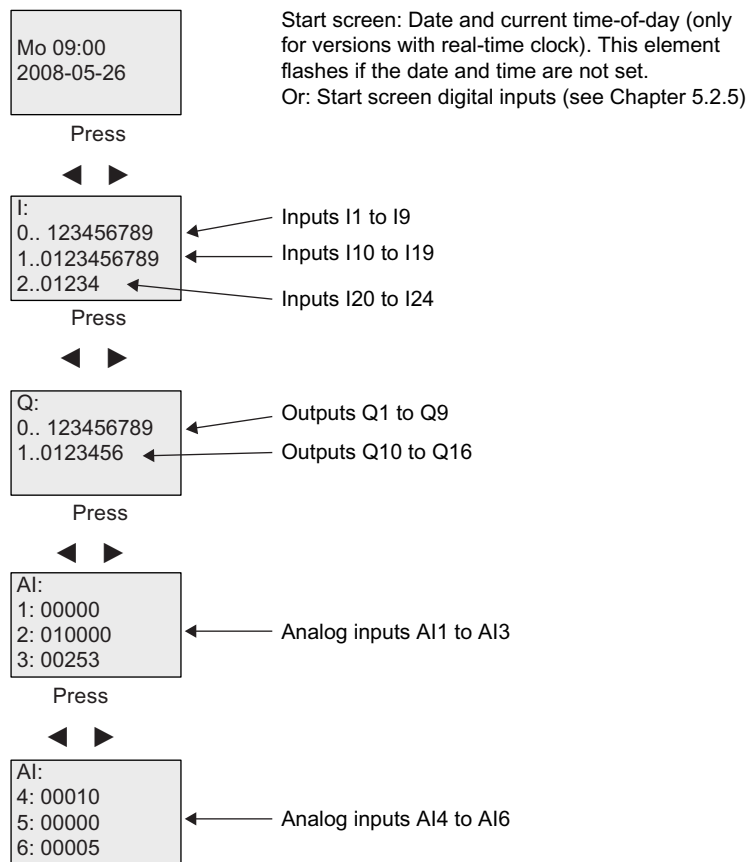

3.7 Writing and starting the circuit program

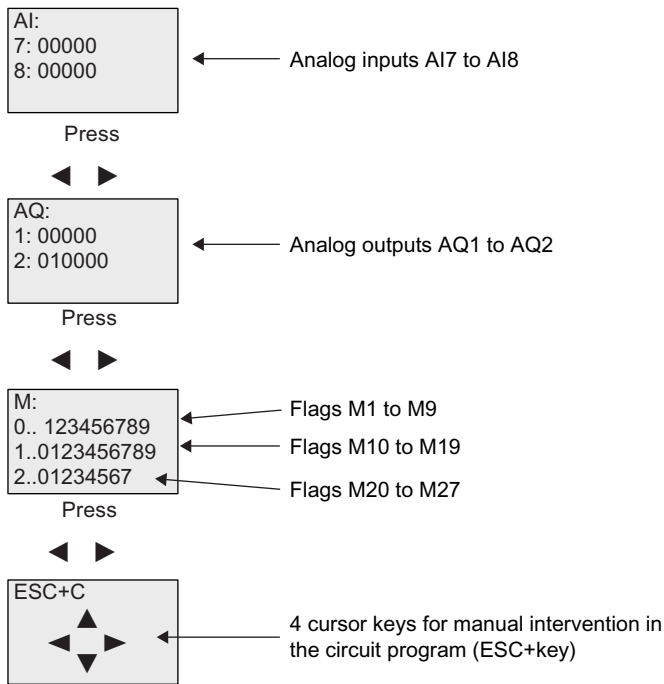

What is meant by: "LOGO! is in RUN"?

In RUN mode, LOGO! executes the circuit program. To do so, LOGO! first reads the status at the inputs, determines the status of the outputs by means of the user program, and switches these on or off according to your settings.

This is how LOGO! indicates the I/O status:

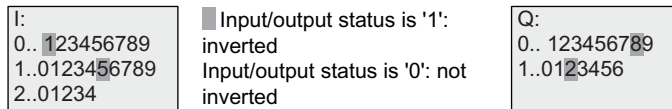

In this example, only the inputs I1, I15, Q8 and Q12 are set "high".

Status indication on the display

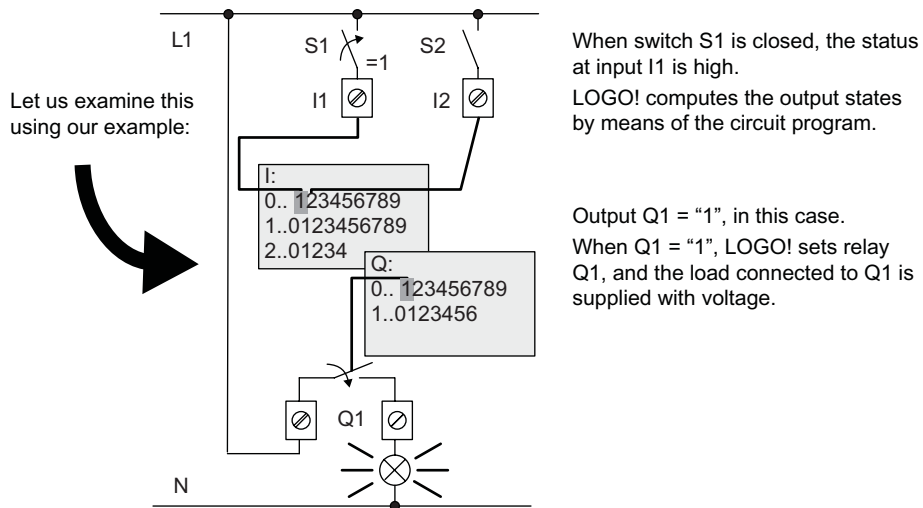

3.7.7 Second circuit program

Up to this point, you have successfully created your first circuit and assigned it a name and, if desired, a password. In this section we will show you how to modify existing circuit programs and how to use the special functions.

Using this second circuit program, we will show you how to:

- Add a block to an existing circuit program.
- Select a block for a special function.
- Assign parameters.

Modifying circuits

We shall use the first circuit program as a basis for the second, with some slight modifications.

First of all take a look at the circuit diagram for the second circuit program:

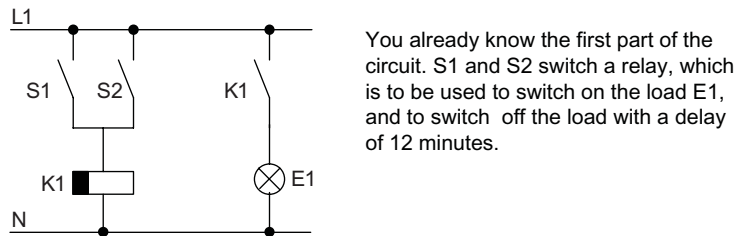

This is the circuit program layout in LOGO!:

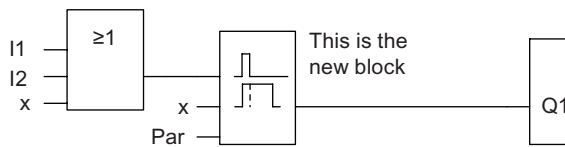

You can see the OR block and the output relay Q1 we have already used in the first circuit program. The only difference is the new off-delay block.

Editing the circuit program

Switch LOGO! to programming mode.

As a reminder:

1. Switch LOGO! to programming mode
(in RUN: Press **ESC** to enter the parameter assignment mode. Select the '**Stop**' command, confirm with **OK**, then move the '>' cursor to '**Yes**', and once again confirm with **OK**). For additional details, see the topic "The four golden rules for operating LOGO! (Page 63)".
2. On the main menu, select "**Program**"
3. On the Programming menu, select "**Edit**", confirm with **OK**. Next, select "**Edit Prg**" and confirm with **OK**.
If required, enter your password at the prompt and confirm with **OK**.

You can now modify the current circuit program.

Adding a block to a circuit program

Move the cursor to the B in B1 (B1 is the number of the OR block):

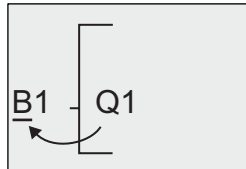

To move the cursor:
Press ◀

We now insert the new block at this position.
Confirm with **OK**.

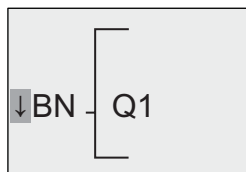

LOGO! shows you the BN list

Press ▼ to select the SF list:

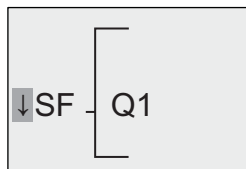

The SF list contains the special function blocks.

Press **OK**.

The block of the first special function is shown:

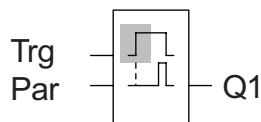

When you select a special or basic function block, LOGO! shows you the relevant function block. The solid square cursor is positioned on the block. Press ▼ or ▲ to select the required block.

Select your block (off-delay, see the next figure), and then press **OK**:

Before you press 'OK',
this shows the entry

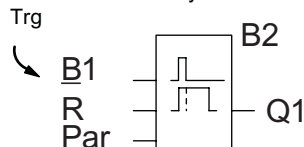

The added block is assigned the block number B2. The cursor is positioned at the top input of the added block.

The B1 block previously connected to Q1 is automatically connected to the uppermost input of the new block. Note that you can only interconnect digital inputs with digital outputs or analog inputs with analog outputs. The 'old' block will otherwise be lost.

The off-delay block has three inputs. At the top is the trigger input (Trg) you use to start the off-delay time. In our example, the OR block B1 triggers the off-delay. You reset the time and the output with a signal at the reset input. Set the off-delay time at parameter T of the input Par.

In our example we do not use the reset input of the off-delay function, and we identify it with an 'x' connector.

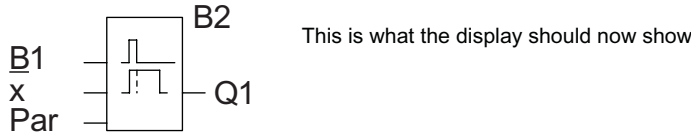

Assigning block parameters

Now you set the off-delay time T:

1. Move the cursor to **Par**, if it not already at this position: Press ▲ or ▼
2. Switch to editing mode: Press **OK**

LOGO! shows the parameters in the parameter assignment window:

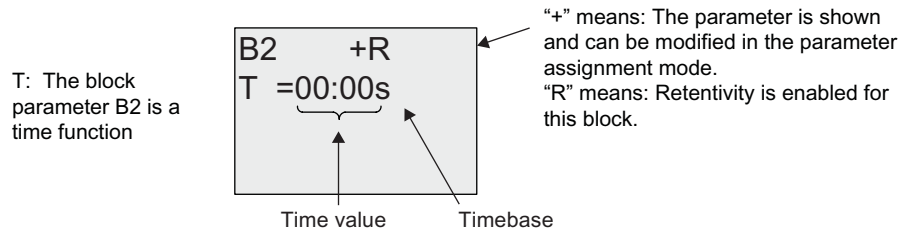

To change the time value:

- Press ◀ and ▶ to position the cursor.
- Press ▲ and ▼ to modify the value at the relevant position.
- Confirm your entries with **OK**.

Setting the time

Set the time T = 12:00 minutes:

1. Move the cursor to the first digit: Press ◀ or ▶
2. Select the digit '1': Press ▲ or ▼
3. Shift the cursor to the second digit: Press ◀ or ▶
4. Select digit '2': Press ▲ or ▼
5. Move the cursor to the unit: Press ◀ or ▶
6. Select the timebase 'm' (for minutes): Press ▲ or ▼

Showing/hiding parameters - the parameter protection mode

If you want to show/hide the parameter and allow/prevent its modification in parameter assignment mode:

1. Move the cursor to the protection mode: Press ◀ or ▶
2. Select the protection mode: Press ▲ or ▼

The display should now show:

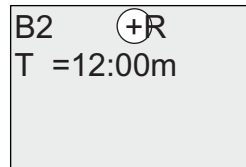

or

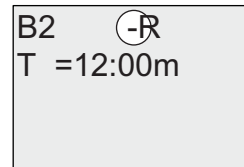

Protection mode +: The value of the time T can be modified in parameter assignment mode

Protection mode -: The value of the time T is hidden in parameter assignment mode

3. Confirm your entries with: **OK**

Enabling/disabling retentivity

To decide whether you want to retain your current data after a power failure or not:

1. Move the cursor to the retentivity setting: Press ◀ or ▶
2. Select the retentivity setting: Press ▲ or ▼

The display now shows:

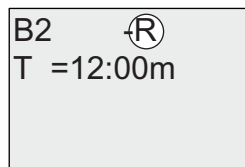

or

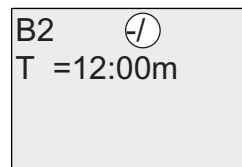

Retentivity R: Current data is retained

Retentivity /: Current data is not retained

3. Confirm your entries with **OK**

Note

For further information on the protection mode, refer to the topic "Parameter protection (Page 114)".

For further information on retentivity, refer to the topic "Retentivity (Page 114)".

You can modify the protection mode and retentivity setting only in programming mode. This is **not** possible in parameter assignment mode.

In this manual, the protection mode ("+" or "-") and retentivity ("R" or "/") settings are only shown in the displays where these can actually be changed.

Verification of the circuit program

This program branch for Q1 is now completed. LOGO! shows you the output Q1. You can once again view the circuit program on the display. Use the keys to browse the circuit program; that is, press ◀ or ▶ to move from block to block, ▲ and ▼ to move between the inputs at a block.

Closing the programming mode

Although you were shown how to exit the programming mode when you created your first circuit program, here is a reminder:

1. Return to the programming menu: Press **ESC**
2. Return to the main menu: Press **ESC**
3. Move the '>' cursor to '**Start**': Press ▲ or ▼
4. Confirm '**Start**': Press **OK**

LOGO! is back in RUN mode:

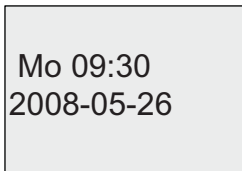

You can press ◀ or ▶ to scroll the pages and to monitor the I/O states.

3.7.8 Deleting a block

Let us assume you want to delete the block B2 from your circuit program and connect B1 directly to Q1.

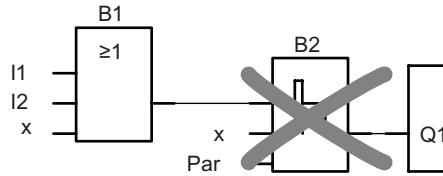

Proceed as follows:

1. Switch LOGO! to programming mode
(as a reminder, refer to the topic "The four golden rules for operating LOGO!" (Page 63)).
2. Select '**Edit**': Press ▲ or ▼
3. Confirm '**Edit**': Press **OK**
(If required, enter your password and confirm with **OK**.)
4. Select '**Edit Prg**': Press ▲ or ▼
5. Confirm '**Edit Prg**': Press **OK**
6. Move the cursor to B2, the input of Q1: Press ◀

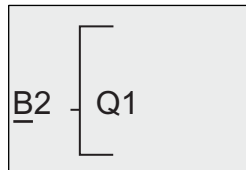

7. Confirm with **OK**.
8. Now replace block B2 with block B1 at output Q1. The procedure:
 - Select the **BNlist**: Press ▲ or ▼
 - Accept the BN list: Press **OK**
 - Select '**B1**': Press ▲ or ▼
 - Apply '**B1**': Press **OK**

Result: Block B2 is deleted, because it is no longer used in the circuit. Block B1 has replaced B2 directly at the output.

3.7.9 Deleting block groups

Let us assume you want to delete the blocks B1 and B2 from the following circuit program (corresponds with the circuit program in the "Second circuit program (Page 82)" topic.

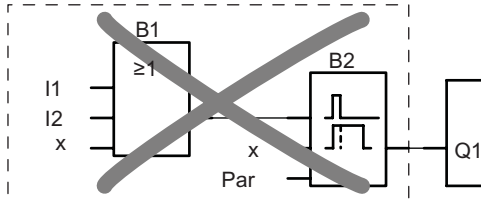

Proceed as follows:

1. Switch LOGO! to programming mode
(as a reminder, refer to the topic "The four golden rules for operating LOGO! (Page 63)").
2. To select 'Edit': Press ▲ or ▼
3. To confirm 'Edit': Press **OK**
(If required, enter your password and confirm with **OK**.)
4. To select 'Edit Prg': Press ▲ or ▼
5. To confirm 'Edit Prg': Press **OK**
6. To move the cursor to the input of Q1; that is, to B2, press ◀:

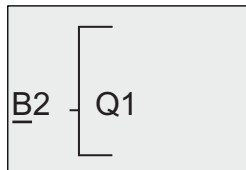

7. Confirm with **OK**.
8. Now set the connector 'x' at output Q1 instead of block B2. To do so:
 - Select the **Co**list: Press ▲ or ▼
 - Accept the Co list: Press **OK**
 - Select 'x': Press ▲ or ▼
 - Apply 'x': Press **OK**

Result: LOGO! deletes block B2 because it is no longer used in the circuit. LOGO! also deletes all blocks that connect to B2, in this case, block B1.

3.7.10 Correcting programming errors

Programming errors can be corrected easily in LOGO!:

- Provided editing mode is not yet closed, you can revert by one step by pressing **ESC**.
- If you have already configured all inputs, simply reconfigure the faulty input:
 1. Move the cursor to the faulty position
 2. Change to editing mode. Press **OK**
 3. Enter the correct input circuit

You can only replace a block with a block that has exactly the same number of inputs. However, you can delete the old block and then insert a new one. You can choose any new block.

3.7.11 Selecting analog output values for RUN/STOP transition

You can select the analog values that are output at the two analog outputs when LOGO! changes from RUN mode to STOP mode.

In the programming menu:

1. Move the ">" cursor to 'Edit.': Press ▼ or ▲
2. Select 'Edit': Press **OK**
3. Move the ">" cursor to 'AQ': Press ▼ or ▲
4. Selectt 'AQ': Press **OK**
5. Move the ">" cursor to 'AQ in Stop': Press ▼ or ▲
6. Select 'AQ in Stop': Press **OK**

LOGO! shows the following display:

```
>Defined
Last
AQ in Stop
Last
```

The first two rows show your choices. The bottom row shows the current setting for the analog output channels. The default setting is 'Last'.

You can select either 'Defined' or 'Last'. 'Last' means that the analog output values are held at their last value and 'Defined' means that the analog output values are set to specific values. When LOGO! changes from RUN mode to STOP mode, the values of the analog outputs change as well, depending on the setting.

7. Select the desired output setting: Press ▲ or ▼.
8. Confirm your entry: Press **OK**

Defining a specific analog output value

To output a specific analog value at the two analog outputs:

1. Move the '>' cursor to **'Defined'**: Press ▲ or ▼
2. Confirm 'Defined': Press **OK**

The display shows:

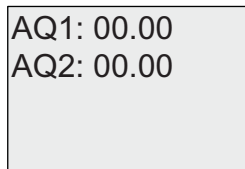

3. Enter a specific output value for each of the two analog outputs.
4. To confirm your entry: Press **OK**

3.7.12 Defining the type of analog outputs

Analog outputs can be either 0..10V/0..20mA, which is the default, or 4..20mA.

To define the type of analog outputs, follow these steps starting from the programming menu:

1. Move the ">" cursor to **'Edit..'**: Press ▼ or ▲
2. Select 'Edit': Press **OK**
3. Move the ">" cursor to **'AQ'**: Press ▼ or ▲
4. Select 'AQ': Press **OK**
5. Move the ">" cursor to **'AQ type'**: Press ▼ or ▲
6. Select 'AQ type': Press **OK**

LOGO! shows the following display, for example:

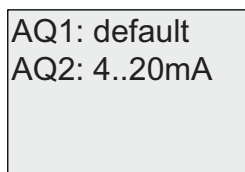

The defined type for each analog channel is shown. To change the type, continue as follows

7. Move to the AQ that you want to change. Press ◀ or ▶
8. Select either default (0..10V/0..20mA) or 4..20mA. Press ▼ or ▲
9. Confirm your selection. Press **OK**

3.7.13 Deleting the circuit program and password

To delete a circuit program and the password if one is defined:

1. Switch the LOGO! to programming mode (main menu).

```
>Program..
Card..
Setup..
Start
```

LOGO! opens the main menu

2. On the main menu, press ▲ or ▼ to move the '>' cursor to '**Program**'. Press **OK**.

```
>Edit..
Clear Prg
Password
Msg Config
```

LOGO! changes to the programming menu

3. On the programming menu, move the '>' cursor to '**Clear Prg**': Press ▲ or ▼
4. Confirm 'Clear Prg': Press **OK**

```
Clear Prg
>No
Yes
```

To cancel deletion of the circuit program, leave the '>' cursor at '**No**' and press **OK**.

If you are sure that you want to delete the circuit program from memory:

5. Move the '>' cursor to '**Yes**': Press ▲ or ▼
6. Press **OK**.

```
Password?
ZZ■
```

To prevent unintentional deletion of your circuit program, you are prompted to enter your password (provided you have assigned one).

7. Enter your password.
8. Press **OK**. The circuit program and the password are deleted.

3.7.14 Summertime/wintertime conversion

You can enable or disable automatic summertime/wintertime conversion

- in parameter assignment mode by calling the "Set.." menu command
- in programming mode by calling the "Setup" menu command.

To enable/disable automatic S/W Time conversion in programming mode:

1. Switch LOGO! to programming mode.
2. You are now in the main menu and want to select the '**Setup**' menu command: Press ▲ or ▼
3. Confirm 'Setup': Press **OK**
4. Move the '>' cursor to '**Clock**': Press ▲ or ▼
5. Confirm 'Clock': Press **OK**
6. Move the '>' cursor to '**S/W Time**': Press ▲ or ▼
7. Confirm 'S/W Time': Press **OK**

LOGO! shows the following display:

```
>On
Off
S/W Time:
Off
```

The current setting of automatic S/W Time conversion is shown on the bottom row. The default setting is 'Off': disabled.

To enable/disable automatic S/W Time conversion in parameter assignment mode:

If you want to enable/disable automatic S/W Time conversion in parameter assignment mode, select in the parameter assignment menu '**Set..**', then menus '**Clock**' and '**S/W Time**'. You can now enable/disable automatic S/W Time conversion.

Enabling summertime/wintertime conversion

You now want to enable this conversion and define or set its parameters:

1. Move the '>' cursor to 'On': Press ▲ or ▼
2. Confirm 'On': Press **OK**

The display shows:

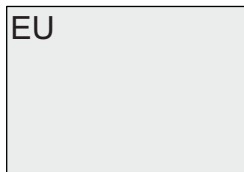

3. Select the desired conversion: Press ▲ or ▼

What is shown on the display ?:

- 'EU' represents the start and end of European summertime.
- 'UK' represents the start and end of summertime in the United Kingdom.
- 'US1' represents the start and end of daylight saving time (summertime) in the United States prior to 2007.
- 'US2' represents the start and end of daylight saving time (summertime) in the United States in 2007 and later years.
- 'AUS' represents the start and end of Australian summertime.
- 'AUS-TAS' represents the start and end of Australian/ Tasmanian summertime.
- 'NZ' represents the start and end of New Zealand summertime.
- . . . : Here you can enter any month, day and time zone difference.

The table below lists the preset conversions:

	Start of summertime	End of summertime	Time zone difference Δ
EU	Last Sunday in March: 02:00→03:00	Last Sunday in October: 03:00→02:00	60 Min.
UK	Last Sunday in March: 01:00→02:00	Last Sunday in October: 02:00→01:00	60 Min.
US1	First Sunday in April: 02:00→03:00	Last Sunday in October: 02:00→01:00	60 Min.
US2	Second Sunday in March: 02:00→03:00	First Sunday in November: 02:00→01:00	60 Min.
AUS	Last Sunday in October: 02:00→03:00	Last Sunday in March: 03:00→02:00	60 Min.
AUS-TAS	First Sunday in October: 02:00→03:00	Last Sunday in March: 03:00→02:00	60 Min.
NZ	First Sunday in October: 02:00→03:00	Third Sunday in March: 03:00→02:00	60 Min.
..	Customized month and day; 02:00→02:00 + Time zone difference	Customized month and day; Time zone difference: 03:00→03:00 - Time zone difference	User-defined (resolution in minutes)

Note

You can specify a time zone difference Δ between 0 and 180 minutes.

The **US2** selection is only supported in LOGO! devices as of the series 0BA6.

Let us assume you want to enable European summertime/wintertime conversion:

1. Move the '>' cursor to '**EU**': Press ▲ or ▼
2. Confirm 'EU': Press **OK**

LOGO! shows the following display:

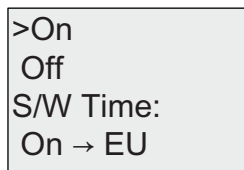

```
>On
Off
S/W Time:
On → EU
```

LOGO! indicates that European S/W Time conversion is enabled.

User-defined parameters

If none of the parameters/conversions apply to your country, you can customize these under menu item '.'. To do so:

1. Confirm 'On' once again: Press **OK**
2. Move the '>' cursor to '.': Press **▲** or **▼**
3. Confirm the menu item '.': Press **OK**

The display shows:

Cursor / solid square

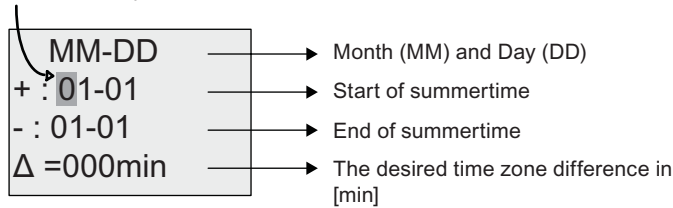

Let us assume you want to configure the following parameters: Start of summertime = 31st March, end of summertime = 1st November, time difference of 120 minutes.

This is how you can enter your data:

- Press **◀** or **▶** to move the solid square/cursor.
- Press **▲** and **▼** to change the value at the cursor position.

The display shows:

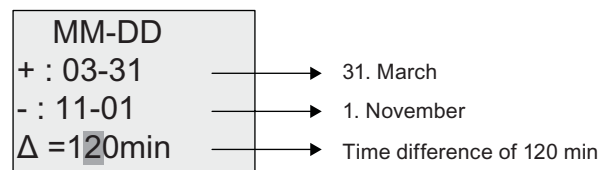

- Confirm all your entries with **OK**.

You have now customized the summertime/wintertime conversion. The LOGO! Display now shows:

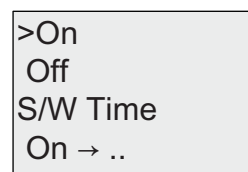

LOGO! indicates that summertime/wintertime conversion is enabled, and that user-defined parameters ('.') have been set.

Note

To disable summertime/wintertime conversion in this menu, you merely confirm 'Off' with **OK**.

Note

Summertime/wintertime conversion only functions when LOGO! is operating (in RUN or STOP status). It does not function when LOGO! is in buffered operation (Page 114).

3.7.15 Synchronization

Time synchronization between LOGO! and a connected communication module EIB/KNX (version 0AA1 upwards!) can be enabled/disabled

- in parameter assignment mode by means of the set menu ("Clock" menu item)
- in programming mode by means of the setup menu ("Clock" menu item).

When synchronization is enabled, LOGO! can receive the time-of-day from a communication module EIB/KNX (version 0AA1 upwards).

Whether synchronization is enabled or disabled, the time-of-day is always sent to the expansion modules at power-up, every hour (STOP mode or RUN mode), and when the TOD is changed (after a 'Set Clock' is executed or after a summertime/wintertime conversion).

Note

When using a LOGO! Basic module with digital or analog expansion modules, but without communication module EIB/KNX (version 0AA1 upwards), time synchronization **must not** be activated! You must check whether time synchronization is deactivated ('Sync' must be set to 'Off').

To enable/disable synchronization in programming mode:

1. Switch LOGO! to programming mode.
2. You are now in the main menu, and want to select '**Setup**': Press ▲ or ▼
3. Confirm '**Setup**': Press **OK**
4. Move the '>' cursor to '**Clock**': Press ▲ or ▼
5. Confirm '**Clock**': Press **OK**
6. Move the '>' cursor to '**Sync**': Press ▲ or ▼
7. Apply '**Sync**': Press **OK**

LOGO! shows the following display:

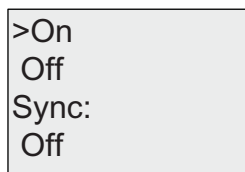

The current setting of the automatic synchronization function is displayed on the bottom row. The default setting is 'Off'; that is, disabled.

To enable/disable synchronization in parameter assignment mode:

If you want to enable/disable automatic synchronization in parameter assignment mode, select in the parameter assignment menu '**Set.**', then menus '**Clock**' and '**Sync**'. You can now enable/disable automatic synchronization.

Enabling synchronization

You want to enable synchronization:

1. Move the '>' cursor to 'On': Press ▲ or ▼
2. Confirm 'On': Press **OK**

LOGO! shows the following display:

```
>On
Off
Sync:
On
```

3.8 Memory space and circuit program size

The size of a circuit program in LOGO! is limited by the memory space (memory used by the blocks).

Memory areas

- **Program memory:**
LOGO! allows only a limited number of blocks in your circuit program.
The second limitation is based on the maximum number of bytes a circuit program may contain. The total number of bytes used can be determined by adding up the number of bytes used for the relevant function blocks.
- **Retentive memory (Rem):**
In this area, LOGO! stores values which need to be retentive; for example, the hours counter value. Blocks with optional retentivity use this memory area only if this function is actually enabled.

Resources available in LOGO!

A circuit program in LOGO! can occupy the following maximum resources:

Bytes	Blocks	REM
3800	200	250

LOGO! monitors memory utilization, and offers only those functions from the lists for which it can actually provide sufficient memory space.

Memory requirements

The table below shows an overview of the memory requirements for the basic and special function blocks:

Function	Program memory	Rem memory*
Basic functions		
AND	12	-
AND with edge evaluation	12	-
NAND (not AND)	12	-
NAND with edge evaluation	12	-
OR	12	-
NOR (not OR)	12	-
XOR (exclusive OR)	8	-
NOT (Negation)	4	-
Special functions		
Timers		
On-delay	8	3
Off-delay	12	3
On-/Off-delay	12	3
Retentive on-delay	12	3
Wiping relay (pulse output)	8	3
Edge triggered wiping relay	16	4
Asynchronous pulse generator	12	3
Random generator	12	-
Stairway lighting switch	12	3
Multiple function switch	16	3
Weekly timer	20	-
Yearly timer	12	-
Counters		
Up/down counter	28	5
Hours counter	28	9
Threshold trigger	16	-
Analog		
Analog threshold trigger	16	-
Analog differential trigger	16	-
Analog comparator	24	-
Analog value monitoring	20	-
Analog amplifier	12	-
Pulse Width Modulator (PWM)	24	-
Analog math	20	-
Analog math error detection	12	1
Analog multiplexer	20	-

Function	Program memory	Rem memory*
Analog ramp	36	-
PI controller	40	2
Others		
Latching relay	8	1
Pulse relay	12	1
Message texts	8	-
Softkey	8	2
Shift register	12	1

*: Bytes in the Rem memory area if retentivity is enabled.

Utilization of memory areas

The system indicates that there is insufficient memory space by not allowing you to add a further block to your circuit program. LOGO! offers you only the blocks for which it can provide sufficient memory space. If LOGO! memory space is insufficient to hold any further blocks you select from a block list, the system will deny access to this list.

If memory space is fully occupied, optimize your circuit program or install a second LOGO!

Calculating memory requirements

When calculating the memory requirements of a circuit, you must always take into account all individual areas of memory.

Example:

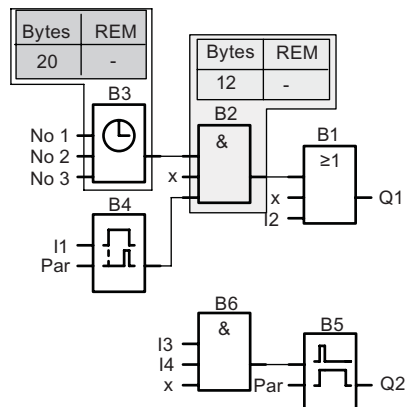

The sample circuit program contains:

Block no.	Function	Memory area		
		Bytes	Blocks	REM
B1	OR	12	1	-
B2	AND	12	1	-
B3	Weekly timer	20	1	-
B4	On-delay*	8	1	3
B5	Stairway lighting switch	12	1	0
B6	AND	12	1	-
	Resources used by the circuit program	76	6	3
	Memory space limits in LOGO!	3800	200	250
	Still available in LOGO!	3724	194	247

*: Configured with retentivity.

This means that this circuit program fits in LOGO!.

Indication of available memory space

LOGO! shows you the amount of free memory space.

Proceed as follows:

1. Switch LOGO! to programming mode
(as a reminder, refer to the topic "The four golden rules for operating LOGO! (Page 63)".
2. Select 'Edit': Press ▲ or ▼
3. Accept 'Edit': Press OK
4. Select 'Memory?': Press ▲ or ▼
5. Accept 'Memory?': Press OK

The display now shows:

Free Memory: Byte =3724 Block= 194 Rem = 247

LOGO! functions

LOGO! provides you with various elements in programming mode, which are organized in the following lists:

- ↓Co: Connector list (Connector) (Page 102)
- ↓GF: List of the basic functions AND, OR, ... (Page 105)
- ↓SF: List of the special functions (Page 117)
- ↓BN: List of reusable blocks configured in the circuit program

List contents

All lists show the elements available in LOGO! Usually, this includes *all* connectors, basic functions, and special functions. The ↓BN list shows all the blocks that you have created in LOGO!.

If not all is shown

LOGO! does *not* show all elements if:

- No further blocks may be added.
This is either an indication of insufficient memory space or that the maximum number of blocks has been reached.
- A specific block's memory space requirement (Page 97) would exceed the space available in LOGO!

4.1 Constants and connectors - Co

Constants and connectors (Co) represent inputs, outputs, flags and constant voltage levels (constants).

Inputs:

1) Digital inputs

Digital inputs are identified with an **I**. The number of the digital inputs (I1, I2, ...) corresponds to the number of the input connectors of the LOGO! Basic and of the connected digital modules, in the order of their installation. The fast digital inputs I3, I4, I5, and I6 of the LOGO! versions LOGO! 24, LOGO! 24o, LOGO! 12/24RC and LOGO! 12/24RCo can be used as fast counters.

2) Analog inputs

The LOGO! versions LOGO! 24, LOGO! 24o, LOGO! 12/24RC and LOGO! 12/24RCo are equipped with the inputs I1, I2, I7 and I8, which can also be programmed for use as **AI3, AI4, AI1** and **AI2** inputs. As described in topic "Setting the number of AIs in the Basic Module (Page 221)", you can configure these modules to use either two analog inputs (AI1 and AI2), or all four. Signals at the I1, I2, I7 and I8 inputs are interpreted as digital values, and those at the AI3, AI4, AI1 and AI2 inputs are interpreted as analog values. Note that AI3 corresponds to I1 and AI4 corresponds to I2. This numbering preserves the previous correspondence of AI1 to I7 and AI2 to I8 that was available with the 0BA5 series. The inputs of a connected analog module are numbered according to the already existing analog inputs. See topic "Maximum setup (Page 26)" for example setups. In programming mode, when you select the input signal of a special function that takes an analog input, LOGO! offers the analog inputs AI1...AI8, analog flags AM1...AM6, analog outputs AQ1 and AQ2, and the block numbers of functions with analog outputs.

Outputs:

1) Digital outputs

Digital outputs are identified by the character **Q**. The output numbers (Q1, Q2, ... Q16) correspond with the numbers of the output connectors at the LOGO! Basic and with those of the expansion modules, in their order of installation. See the following figure.

There are also 16 blank outputs available. These are identified with an **x** and cannot be reused in a circuit program (in contrast to flags, for example). The list shows all programmed blank outputs, and one blank output which is not yet configured. A blank output, for example, is useful for the special function "Message texts" (Page 175), if only the message text is of significance to a circuit program.

2) Analog outputs

Analog outputs are identified by the letters **AQ**. Two analog outputs are available, namely AQ1 and AQ2. An analog output can only be connected with the analog input of a function, an analog flag AM or an analog output connector.

The following figure shows an example LOGO! configuration and the numbering of the inputs and outputs for the circuit program.

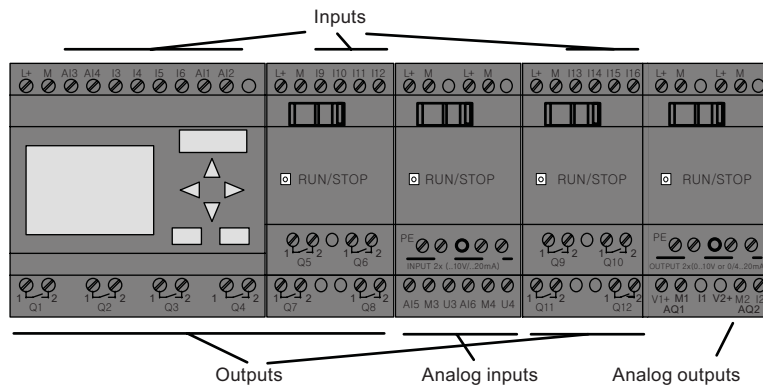

Flag blocks

Flag blocks are identified by the letters **M** or **AM**. These are virtual outputs, which output the value of their inputs. LOGO! provides 27 digital flags M1 ... M27 and 6 analog flags AM1 ... AM6.

Startup flag

Flag M8 is set in the first cycle of the user program and can thus be used in your circuit program as a startup flag. This signal is automatically reset after the circuit program has completed its first cycle.

The M8 flag can be used in all further cycles for setting, deletion and evaluation procedures in the same way as other flags.

Backlight flags M25 and M26

The M25 flag controls the backlight of the LOGO! Display. The M26 flag controls the backlight of the LOGO! TD.

Note: The backlight lifetime of the LOGO! TD is 20,000 hours.

Message text character set flag M27

The M27 flag selects between the two character sets that LOGO! uses to display message texts. State 0 corresponds to Character Set 1, and state 1 corresponds to Character Set 2. If M27=0 (low), only message texts configured for Character Set 1 will display; If M27=1 (high), only message texts configured for Character Set 2 will display. If you do not include M27 in the circuit program, message texts display in the character set that you selected from either the Msg Config menu or from LOGO!Soft Comfort.

Note

The output of the flag always carries the signal of the previous program cycle. This value does not change within the same program cycle.

Shift register bits

LOGO! provides the shift register bits S1 to S8, which are assigned the read-only attribute in the circuit program. The content of shift register bits can only be modified by means of the "Shift register" (Page 188) special function.

Cursor keys

Up to four cursor keys are available to you, namely C ▲, C ►, C ▼ and C ◀ ("C" = "Cursor"). Cursor keys are programmed for the circuit program in the same way as other inputs. You can set the cursor keys in the corresponding display while the system is in RUN (Page 79) , and in an active message text (ESC + Key). Cursor keys can save switches and inputs, and allow operator control of the circuit program. Cursor key inputs from the LOGO! TD are identical to cursor key inputs from the LOGO! Basic module.

LOGO! TD function keys

The LOGO! TD has four function keys that you can use in your circuit program. You program these keys in the same way as other inputs. Like the cursor keys, you can press these keys when LOGO! is in RUN mode to affect the behavior of the circuit program, and to save switches and inputs. They are identified as F1, F2, F3, and F4.

Levels

Voltage levels are designated **hi** and **lo**. A constant "1" = hi or "0" = lo status at the block can be set by means of a permanent voltage level or constant value hi or lo.

Open connectors

Unused block connectors can be identified with an **x**.

4.2 Basic functions list - GF

Basic functions represent simple logical elements of Boolean algebra.

You can invert the inputs of individual basic functions, that is, the circuit program inverts a logical "1" at a relevant input to a logical "0"; if "0" is set at the input, the program sets a logical "1". See the programming example at Circuit program input (Page 69).

The GF list contains the basic function blocks you can use for your circuit program. The following basic functions are available:

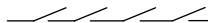
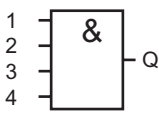
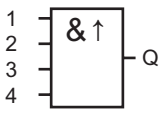
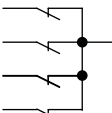
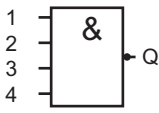
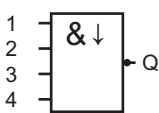
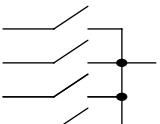
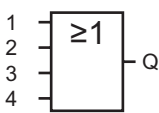
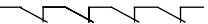
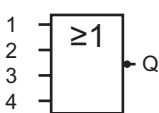
View in the circuit diagram	View in LOGO!	Name of the basic function
 <p>Series circuit make contact</p>		AND (Page 106)
		AND with edge evaluation (Page 107)
 <p>Parallel circuit with break contacts</p>		NAND (Page 108) (not AND)
		NAND with edge evaluation (Page 108)
 <p>Parallel circuit with make contacts</p>		OR (Page 109)
 <p>Series circuit with break contacts</p>		NOR (Page 110) (not OR)

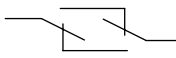
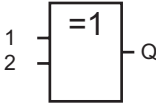
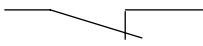
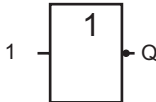
View in the circuit diagram	View in LOGO!	Name of the basic function
 <p>Double changeover contact</p>		XOR (Page 111) (exclusive OR)
 <p>Break contact</p>		NOT (Page 111) (negation, inverter)

4.2.1 AND

Circuit diagram of a series circuit with several make contacts:

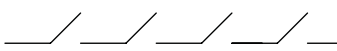

Symbol in LOGO!:

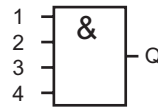

The output of the AND is only 1 if **all** inputs are 1, i.e. all contacts are closed.

At an unused block input (x): x = 1.

AND function logic table

1	2	3	4	Q
0	0	0	0	0
0	0	0	1	0
0	0	1	0	0
0	0	1	1	0
0	1	0	0	0
0	1	0	1	0
0	1	1	0	0
0	1	1	1	0
1	0	0	0	0
1	0	0	1	0
1	0	1	0	0
1	0	1	1	0
1	1	0	0	0
1	1	0	1	0
1	1	1	0	0
1	1	1	1	1

4.2.2 AND with edge evaluation

Symbol in LOGO!:

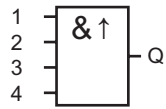

The output of an edge triggered AND is only 1 if **all** inputs are 1 and if **at least one** input was low in the previous cycle.

At an unused block input (x): $x = 1$.

Timing diagram for the AND with edge evaluation

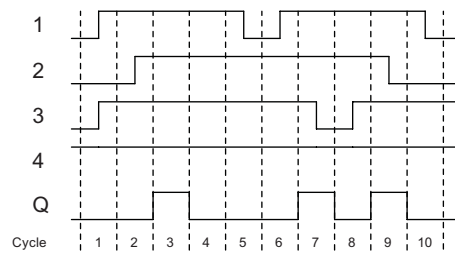

4.2.3 NAND (not AND)

Parallel circuit with multiple break contacts in the circuit diagram:

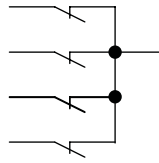

Symbol in LOGO!:

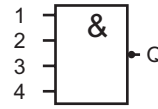

The output of the NAND is only 0 if the status at **all** inputs is 1, i.e. the contacts are closed.

At an unused block input (x): x = 1.

NAND function logic table

1	2	3	4	Q
0	0	0	0	1
0	0	0	1	1
0	0	1	0	1
0	0	1	1	1
0	1	0	0	1
0	1	0	1	1
0	1	1	0	1
0	1	1	1	1
1	0	0	0	1
1	0	0	1	1
1	0	1	0	1
1	0	1	1	1
1	1	0	0	1
1	1	0	1	1
1	1	1	0	1
1	1	1	1	0

4.2.4 NAND with edge evaluation

Symbol in LOGO!:

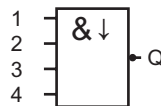

The output status of the NAND with edge evaluation is only 1 if **at least one** input is 0 and if **all** inputs were 1 in the previous cycle.

At an unused block input (x): x = 1.

Timing diagram for the NAND with edge evaluation

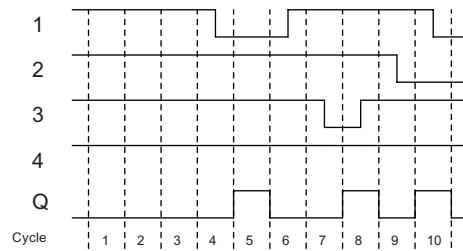

4.2.5 OR

Circuit diagram of a parallel circuit with several make contacts:

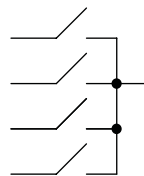

Symbol in LOGO!:

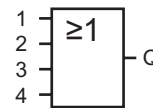

The output status of the OR element is only 1 if **at least one** input is 1, i.e. at least one of the contacts is closed.

At an unused block input (x): $x = 0$.

OR function logic table

1	2	3	4	Q
0	0	0	0	0
0	0	0	1	1
0	0	1	0	1
0	0	1	1	1
0	1	0	0	1
0	1	0	1	1
0	1	1	0	1
0	1	1	1	1
1	0	0	0	1
1	0	0	1	1
1	0	1	0	1
1	0	1	1	1
1	1	0	0	1
1	1	0	1	1
1	1	1	0	1
1	1	1	1	1

4.2.6 NOR (not OR)

Circuit diagram of a series circuit with several break contacts:

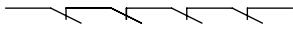

Symbol in LOGO!:

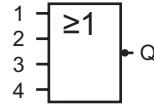

The output status of the NOR is only 1 if **all** inputs are 0, i.e. if switched off. The NOR output is set to 0 when one of the inputs is switched on (logical 1 status).

At an unused block input (x): x = 0.

NOR function logic table

1	2	3	4	Q
0	0	0	0	1
0	0	0	1	0
0	0	1	0	0
0	0	1	1	0
0	1	0	0	0
0	1	0	1	0
0	1	1	0	0
0	1	1	1	0
1	0	0	0	0
1	0	0	1	0
1	0	1	0	0
1	0	1	1	0
1	1	0	0	0
1	1	0	1	0
1	1	1	0	0
1	1	1	1	0

4.2.7 XOR (exclusive OR)

The XOR in a circuit diagram, shown as series circuit with 2 changeover contacts:

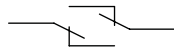

Symbol in LOGO!:

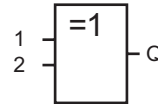

The output status of the XOR is 1 if the inputs are **not equivalent**.

At an unused block input (x): x = 0.

XOR function logic table

1	2	Q
0	0	0
0	1	1
1	0	1
1	1	0

4.2.8 NOT (Negation, Inverter)

A break contact in the circuit diagram:

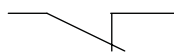

Symbol in LOGO!:

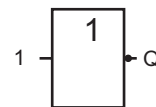

The output status is 1 if the input is 0. The NOT block inverts the input status.

Advantage of the NOT block, for example: LOGO! does not require break contacts. You simply use a make contact and the NOT block to convert these into a break contact.

NOT function logic table

1	Q
0	1
1	0

4.3 Special Functions

Because of their different input designation, you can see right away that there is a difference between the special functions and basic functions. Special functions (SFs) contain timer functions, retentive functions and various parameter assignment options, which allow you to adapt the circuit program to suit your own requirements.

This section provides you with a brief overview of input designations and with some particular background information on SFs (Page 117).

4.3.1 Designation of the inputs

Logical inputs

Here, you will find the description of the connectors you can use to create a logical link to other blocks or to the inputs of the LOGO! unit.

- **S (Set):**
A signal at input S sets the output to logical "1".
- **R (Reset):**
The reset input R takes priority over all other inputs and resets the outputs.
- **Trg (Trigger):**
This input is used to trigger the start of a function.
- **Cnt (Count):**
This input is used for counting pulses.
- **Fre (Frequency):**
Frequency signals to be evaluated are applied to this input.
- **Dir (Direction):**
This input determines the direction, + or -.
- **En (Enable):**
This input enables a block function. When this input is "0", other signals to the block will be ignored.
- **Inv (Invert):**
A signal at this input inverts the output signal of the block.
- **Ral (Reset all):**
All internal values are reset.

Note

Unused logical inputs of special functions default to logical "0".

Connector X at SF inputs

SF inputs connected to connector x are set low. That is, the inputs carry a 'lo' signal.

Parameter inputs

At some of the inputs you do not apply any signals. You configure the relevant block values instead. Examples:

- **Par (Parameter):**
This input will not be connected. Here, you set the relevant block parameters (times, on/off thresholds etc.).
- **No (Cam):**
This input will not be connected. Here, you configure the time patterns.
- **P (Priority):**
This is an open input. Here, you define priorities and specify whether a message is to be acknowledged in RUN.

4.3.2 Time response

Parameter T

At some of the SFs it is possible to configure a time value T. When you preset this time, note that your input values are based on the timebase set:

Timebase	-- : --
s (seconds)	seconds : ¹ / ₁₀₀ seconds
m (minutes)	minutes : seconds
h (hours)	hours : minutes

<p>B1 + T =04:10h</p>

Setting a time T of 250 minutes:
Unit in hours h:

04:00 hours	240 minutes
00:10 hours	+10 minutes
=	250

Accuracy of T

Because of slight tolerances in the characteristics of electronic components, the set time T can deviate. You can find a detailed description of such deviations in the "On-delay" topic (Page 120).

Accuracy of the timer (weekly/yearly timer)

To prevent timing inaccuracy of the real-time clock in C versions caused by this deviation, the timer value is continuously compared with a high-precision timebase and corrected. The resultant maximum timing inaccuracy is ± 5 s/day.

4.3.3 Backup of the real-time clock

Because the internal real-time clock of a LOGO! is backed up, it continues operation after a power failure. The ambient temperature influences the backup time. At an ambient temperature of 25°C, the typical backup time is 80 hours.

If there is a power outage of a LOGO! for more than 80 hours, the internal clock responds, dependent on the equipment series, as shown below:

- Equipment series 0BA0:
On restarting, the clock is set to "Sunday 00:00 1 January". The time starts to run. Due to this, the system processes the time switches, which trigger actions if necessary.
- Equipment series 0BA1 and later:
On restarting, the clock is set to "Sunday 00:00 1 January". The time is stopped and flashes. LOGO! is back in the status that it was in before the power outage. In the RUN status, the system processes the counters that were parameterized with the time above. The clock is, however, still stopped.
- Equipment series 0BA6:
If you are using the optional LOGO! Battery card, or combined LOGO! Memory/Battery card, LOGO! can retain the clock time for up to two years. These cards are available for equipment series 0BA6.

4.3.4 Retentivity

The switching states, counter and time values of many SFs (see the "Special functions list - SF (Page 117)" topic) can be set retentive. This means that current data values are retained after a power failure, and that the block resumes operation at the break point. The timer is not reset, but resumes operation until the time-to-go has expired, for example.

To enable this response, however, the relevant functions must be set retentive. Two options are available:

R: The data is retained.

/: Current data is not retained (default). See the section in topic "Second circuit program (Page 82)" on enabling and disabling retentivity.

SFs hours counter, weekly timer, yearly timer and PI controller are always retentive.

4.3.5 Parameter protection

In the parameter protection settings, you can determine whether or not the parameters can be displayed and edited in LOGO! parameter assignment mode. Two options are available:

+: The parameter attribute permits read/write access in parameter assignment mode (default).

-: The parameter settings are read-/write-protected in parameter assignment mode, and can be edited only in programming mode. See the parameter protection mode example in the Second circuit program (Page 82).

Note

Parameter protection covers only the "Set Param" window. If you embed variables of protected special functions in a message text, the variables are still editable from the message text. To protect these variables, you can also activate the protection of the message text.

4.3.6 Calculating the gain and offset of analog values

A sensor is connected to the analog input and converts a process variable into an electrical signal. This value of signal lies within the typical range of this sensor.

LOGO! always converts the electrical signals at the analog input into digital values from 0 to 1000.

A voltage of 0 to 10 V at input AI is transformed internally into a range of values from 0 to 1000. An input voltage exceeding 10 V is shown as internal value 1000.

Because you cannot always process the range of values from 0 to 1000 as predetermined by LOGO!, you can multiply the digital values by a gain factor and then shift the zero of the range of values (offset). This allows you to output an analog value to the LOGO! Display, which is proportional to the actual process variable.

Parameter	Minimum	Maximum
Input voltage (in V)	0	≥ 10
Internal value	0	1000
Gain	-10.00	+10.00
Offset	-10000	+10000

Mathematical rule

Actual value Ax =
(internal value at input Ax • gain) + offset

Gain and offset calculation

The gain and offset is calculated based on the relevant high and low values of the function.

Example 1:

The available thermocouples have the following technical data: -30 to +70 °C, 0 to 10 V DC (i.e. 0 to 1000 in LOGO!).

Actual value = (internal value • gain) + offset, thus

$$-30 = (0 \cdot A) + B, \text{ i.e. offset } B = -30$$

$$+70 = (1000 \cdot A) - 30, \text{ i.e. gain } A = 0.1$$

Example 2:

A pressure sensor converts a pressure of 1000 mbar into a voltage of 0 V, and a pressure of 5000 mbar into a voltage of 10 V.

Actual value = (internal value • gain) + offset, thus

$$1000 = (0 \cdot A) + B, \text{ i.e. offset } B = 1000$$

$$5000 = (1000 \cdot A) + 1000, \text{ i.e. gain } A = 4$$

Example of analog values

Process variable	Voltage (V)	Internal value	Gain	Offset	Value shown (Ax)
-30 °C	0	0	0.1	-30	-30
0 °C	3	300	0.1	-30	0
+70 °C	10	1000	0.1	-30	70
1000 mbar	0	0	4	1000	1000
3700 mbar	6.75	675	4	1000	3700
5000 mbar	10	1000	4	1000	5000
	0	0	0.01	0	0
	5	500	0.01	0	5
	10	1000	0.01	0	10
	0	0	1	0	0
	5	500	1	0	500
	10	1000	1	0	1000
	0	0	10	0	0
	5	500	10	0	5000
	10	1000	10	0	10000
	0	0	0.01	5	5
	5	500	0.01	5	10
	10	1000	0.01	5	15
	0	0	1	500	500
	5	500	1	500	1000
	10	1000	1	500	1500
	0	0	1	-200	-200
	5	500	1	-200	300
	10	1000	1	-200	800
	0	0	10	-10000	-10000
	10	1000	10	-10000	0
	0.02	2	0.01	0	0
	0.02	2	0.1	0	0
	0.02	2	1	0	2
	0.02	2	10	0	20

A sample application is found in the description of the "Analog comparator (Page 163)" SF.

For further information on analog inputs, refer to the Constants and connectors - Co (Page 102) topic.









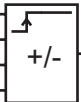
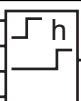

4.4 Special functions list - SF

When you create your circuit program in LOGO!, you find the special function blocks in the SF list.

You can invert the inputs of SFs individually, that is, the circuit program converts a logical "1" at the input into a logical "0"; a logical "0" it converts into a logical "1". See the programming example in topic "Circuit program input (Page 69)".

The table also specifies whether the relevant function can be set retentive (Rem). The following SFs are available:

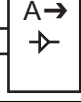
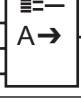
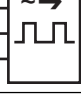
View in LOGO!	Name of the special function	Rem
Times		
	On-delay (Page 120)	REM
	Off-delay (Page 123)	REM
	On-/Off-delay (Page 124)	REM
	Retentive on-delay (Page 126)	REM
	Wiping relay (pulse output) (Page 127)	REM
	Edge triggered wiping relay (Page 128)	REM
	Asynchronous pulse generator (Page 130)	REM
	Random generator (Page 132)	
	Stairway lighting switch (Page 133)	REM
	Multiple function switch (Page 136)	REM

View in LOGO!	Name of the special function	Rem
No1  Q No2 No3 Par	Weekly timer (Page 138)	
No  Q	Yearly timer (Page 142)	
Counter		
R  Q Cnt Dir Par	Up/down counter (Page 147)	REM
R  Q En Ral Par	Hours counter (Page 150)	REM
Fre  Q Par	Threshold trigger (Page 154)	
Analog		
Ax  Q Par	Analog threshold trigger (Page 157)	
Ax  Q Par	Analog differential trigger (Page 160)	
Ax  Q Ay Par	Analog comparator (Page 163)	
En  Q Ax Par	Analog value monitoring (Page 167)	
Ax  AQ Par	Analog amplifier (Page 170)	
En  AQ S1 S2 Par	Analog multiplexer (Page 190)	
En  Q Ax Par	Pulse Width Modulator (PWM) (Page 201)	
En  AQ Par	Analog math (Page 204)	

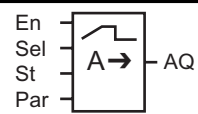
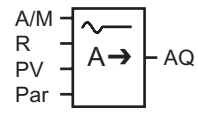
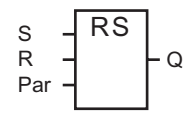
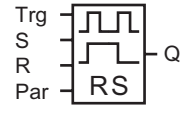
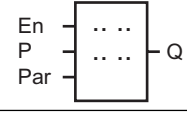
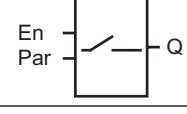
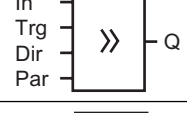
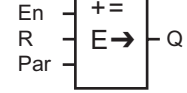
View in LOGO!	Name of the special function	Rem
	Analog ramp (Page 192)	
	PI controller (Page 196)	REM
Miscellaneous		
	Latching relay (Page 172)	REM
	Pulse relay (Page 173)	REM
	Message texts (Page 175)	
	Softkey (Page 186)	REM
	Shift register (Page 188)	REM
	Analog math error detection (Page 207)	

4.4.1 On-delay

Short description

The output is only set after a configurable on-delay time has expired.

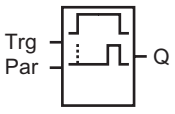
Symbol in LOGO!	Wiring	Description
	Input Trg	A signal at input Trg (Trigger) triggers the on-delay timer.
	Parameter	T represents the time after which the output is switched on (0 to 1 transition of the output signal). Retentivity: / = no retentivity R = the status is retentive.
	Output Q	Q is switched on when the set time T has expired, provided Trg is still set.

Parameter T

Note the defaults for parameter T in topic Time response (Page 113).

The time for parameter T can also be preset based on the actual value of another, already-configured function. You can use the actual values of the following functions:

- Analog comparator (Page 163) (actual value Ax - Ay)
- Analog threshold trigger (Page 157) (actual value Ax)
- Analog amplifier (Page 170) (actual value Ax)
- Analog multiplexer (Page 190) (actual value AQ)
- Analog ramp (Page 192) (actual value AQ)
- Analog math (Page 204) (actual value AQ)
- PI controller (Page 196) (actual value AQ)
- Up/down counter (Page 147) (actual value Cnt)

Select the required function by the block number. The timebase is adjustable. Please note the following listing:

Valid ranges of the timebase, if T = parameter

Timebase	max. value	min. resolution	Accuracy
s (seconds)	99:99	10 ms	+ 10 ms
m (minutes)	99:59	1s	+ 1 s
h (hours)	99:59	1 min	+ 1 min

The display in programming mode (example):

```

B12   +R
T =04:10h
```

Valid ranges of the timebase, if T = Actual value of an already-programmed function

Timebase	max. value	Meaning	Accuracy
ms	99990	Number of ms	+ 10 ms
s	5999	Number of s	+ 1 s
m	5999	Number of min	+ 1 min

The display in programming mode (example):

```

B12   +R
T →B006s
```

If the referenced block (B6, in the example) returns a value that lies out of the valid range, the value is rounded up or down to the next valid value.

Parameter preset = Actual value of an already-programmed function

How to include the actual value of an already-programmed function:

1. Press **▶** to move the cursor to the equal sign of parameter T.

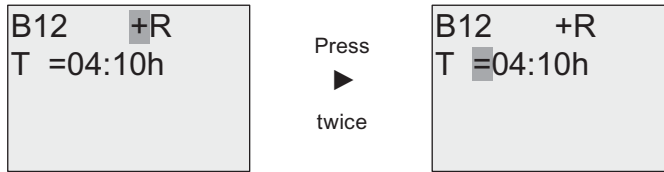

2. Press **▼** to change the equal sign into an arrow. If it exists, the last referenced block and its timebase is shown.

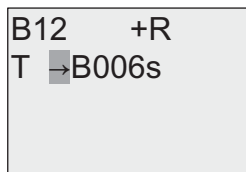

3. Press **▶** to move the cursor to the "B" of the shown block, and then press **▼** to select the required block number.
4. Press **▶** to move the cursor to the block's timebase and press **▼** to select the required timebase.

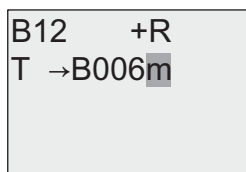

The view in parameter assignment mode (example):

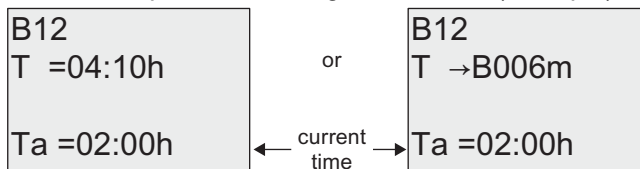

Timing diagram

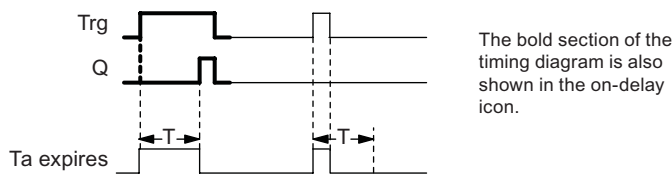

Functional description

The time T_a is triggered with a 0 to 1 transition at input Trg (T_a is the current LOGO! time).
 If the status of input Trg is 1 at least for the duration of the configured time T, the output is set to 1 on expiration of this time (the output follows the input with on-delay).
 The time is reset when the status at input Trg returns to 0 before the time T has expired.
 The output is reset to 0 when the signal at input Trg is 0.
 If retentivity is not set, output Q and the expired time are reset after a power failure.

4.4.2 Off-delay

Short description

When an on-delay is set, the output is reset when the configured time has expired.

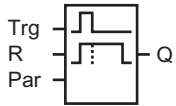
Symbol in LOGO!	Wiring	Description
	Input Trg	The off-delay timer starts with a negative edge (1 to 0 transition) at input Trg (Trigger)
	Input R	A signal at input R resets the on-delay time and the output.
	Parameter	The output switches off (transitions from 1 to 0) when the delay time T expires. Retentivity: / = No retentivity R = The status is retentive.
	Output Q	Q is set with a signal at input Trg. It holds this state until T has expired.

Parameter T

Note the parameter T defaults specified in topic Time response (Page 113).

The time for parameter T can be based on the actual value of another, already-configured function. You can use the actual value of the following functions:

- Analog comparator (Page 163) (actual value Ax - Ay)
- Analog threshold trigger (Page 157) (actual value Ax)
- Analog amplifier (Page 170) (actual value Ax)
- Analog multiplexer (Page 190) (actual value AQ)
- Analog ramp (Page 192) (actual value AQ)
- Analog math (Page 204) (actual value AQ)
- PI controller (Page 196) (actual value AQ)
- Up/down counter (Page 147) (actual value Cnt)

Select the required function by the block number. The timebase is configurable. For information on valid timebase ranges and parameter preset, refer to the On-delay (Page 120) topic.

Timing diagram

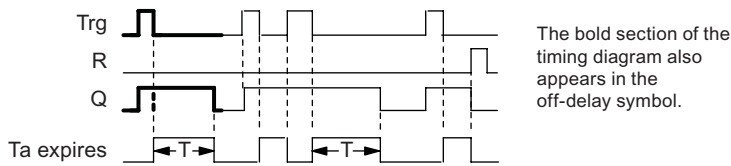

Functional description

Output Q is set to hi immediately when the input Trg changes to hi.

The actual time T_a in LOGO! is retrIGGERED at the 1 to 0 transition of Trg. The output remains set. Output Q is reset to 0 with off-delay when T_a reaches the value configured at T ($T_a=T$).

The time T_a is retrIGGERED with a one-shot at input Trg.

You can set input R (Reset) to reset the time T_a and the output before T_a has expired.

If retentivity is not set, output Q and the expired time are reset after a power failure.

4.4.3 On-/Off-delay

Short description

The on-/off-delay function sets the output after the set on-delay time has expired, and resets it upon expiration of the off-delay time.

Symbol in LOGO!	Wiring	Description
	Input Trg	A positive edge (0 to 1 transition) at input Trg (Trigger) triggers the on-delay time T_H . A negative edge (1 to 0 transition) at input Trg (Trigger) triggers the off-delay time T_L .
	Parameter	T_H is the time after which the output is set hi (output signal transition 0 to 1). T_L is the time after which the output is reset (output signal transition 1 to 0). Retentivity: / = No retentivity R = The status is retentive.
	Output Q	Q is set when the configured time T_H has expired and Trg is still set. It is reset on expiration of the time T_L , if the trigger Trg has not been set again.

Parameters T_H and T_L

Note the preset values for the parameters T_H and T_L in topic Time response (Page 113).

The on-delay and off-delay times for parameters T_H and T_L can be based on the actual value of another, already-configured function. You can use the actual values of the following functions:

- Analog comparator (Page 163) (actual value Ax - Ay)
- Analog threshold trigger (Page 157) (actual value Ax)
- Analog amplifier (Page 170) (actual value Ax)
- Analog multiplexer (Page 190) (actual value AQ)
- Analog ramp (Page 192) (actual value AQ)
- Analog math (Page 204) (actual value AQ)
- PI controller (Page 196) (actual value AQ)
- Up/down counter (Page 147) (actual value Cnt)

Select the required function by the block number. The timebase is configurable. For information on valid timebase ranges and parameter preset, refer to the On-delay (Page 120).

Timing diagram

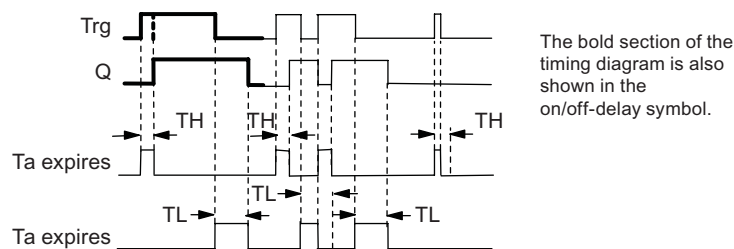

Functional description

The time T_H is triggered with a 0 to 1 transition at input Trg.

If the status at input Trg is 1 at least for the duration of the time T_H , the output is set to 1 on expiration of the time T_H (the output follows the input with on-delay).

The time is reset when the signal at input Trg is reset to 0 before the time T_H has expired.

A 1 to 0 transition at input Trg triggers the time T_L .

If the status at input Trg is 0 at least for the duration of the signal T_L , the output is set to 0 on expiration of the time T_L (the output follows the input with off-delay).

The time is reset when the signal at input Trg changes to 1 again before the time T_L has expired.

If retentivity is not set, output Q and the expired time are reset after a power failure.

4.4.4 Retentive on-delay

Short description

A one-shot at the input triggers a configurable on-delay time. The output is set when this time has expired.

Symbol in LOGO!	Wiring	Description
	Input Trg	A signal at input Trg (Trigger) triggers the on-delay timer.
	Input R	A signal at input R resets the on-delay time and the output.
	Parameter	T represents the on-delay time for the output (output status transition 0 to 1). Retentivity: / = no retentivity R = The status is retentive.
	Output Q	Q is set after the time T has expired.

Parameter T

Note the defaults specified in topic Time response (Page 113).

The time for parameter T can be provided by the actual value of another already-programmed function. You can use the actual values of the following functions:

- Analog comparator (Page 163) (actual value Ax – Ay)
- Analog threshold trigger (Page 157) (actual value Ax)
- Analog amplifier (Page 170) (actual value Ax)
- Analog multiplexer (Page 190) (actual value AQ)
- Analog ramp (Page 192) (actual value AQ)
- Analog math (Page 204) (actual value AQ)
- PI controller (Page 196) (actual value AQ)
- Up/down counter (Page 147) (actual value Cnt)

Select the required function by the block number. The timebase is configurable. For information on valid ranges and parameter defaults, refer to the On-delay (Page 120) topic.

Timing diagram

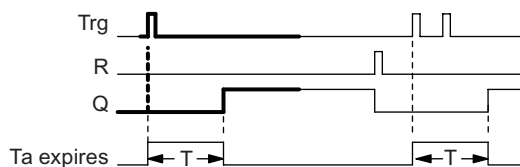

The bold section of the timing diagram is also shown in the symbol of the retentive on-delay.

Functional description

The 0 to 1 signal transition at input Trg triggers the current time T_a . Output Q is set when $T_a = T$. A further signal at input Trg does not influence the time T_a .

The output and the time T_a are reset with the next 1 signal at input R.

If retentivity is not set, output Q and the expired time are reset after a power failure.

4.4.5 Wiping relay (pulse output)

Short description

An input signal generates a signal with a configurable period at the output.

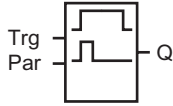
Symbol in LOGO!	Wiring	Description
	Input Trg	A signal at input Trg (Trigger) triggers the time for the wiping relay function.
	Parameter	The output is switched off after the time T has expired (output signal transition 1 to 0). Retentivity: / = No retentivity R = The status is retentive.
	Output Q	A signal at input Trg sets Q. If the input signal = 1, output Q remains set for the time T_a .

Parameter T

Note the information on parameter T in topic Time response (Page 113).

The time for parameter T can be provided by the actual value of another already-programmed function. You can use the actual values of the following functions:

- Analog comparator (Page 163) (actual value $A_x - A_y$)
- Analog threshold trigger (Page 157) (actual value A_x)
- Analog amplifier (Page 170) (actual value A_x)
- Analog multiplexer (Page 190) (actual value AQ)
- Analog ramp (Page 192) (actual value AQ)
- Analog math (Page 204) (actual value AQ)
- PI controller (Page 196) (actual value AQ)
- Up/down counter (Page 147) (actual value Cnt)

Select the required function by the block number. The timebase is configurable. For information on valid ranges and parameter defaults, refer to the On-delay (Page 120) topic.

Timing diagram

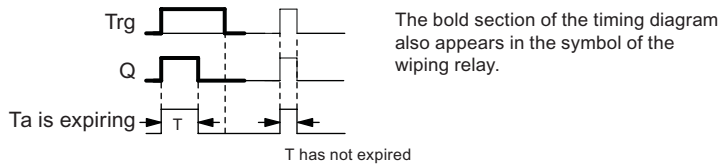

Functional description

A 0 to 1 transition at input Trg sets the output, and triggers a time T_a during which the output remains set.

Output Q is reset to lo (pulse output) when T_a reaches the value preset at T ($T_a = T$).

The output is immediately reset if there is a 1 to 0 transition at input Trg before the specified time has expired.

If retentivity is not set, output Q and the expired time are reset after a power failure.

4.4.6 Edge triggered wiping relay

Short description

An input pulse generates a preset number of output pulses with a defined pulse/pause ratio (retriggerable), after a configured delay time has expired.

Symbol in LOGO!	Wiring	Description
	Input Trg	A signal at input Trg (Trigger) triggers the times for the edge triggered wiping relay.
	Input R	A signal at input R resets the current time (T_a) and the output.
	Parameter	The interpulse width T_L and the pulse width T_H are configurable. N determines the number of pulse/pause cycles TL/TH: Range of values: 1...9 Retentivity: / = No retentivity R = The status is retentive.
	Output Q	Q is set after T_L has expired, and reset after T_H has expired.

Parameters TH and TL

Note the information on parameter T in topic Time response (Page 113).

The pulse width TH and the interpulse width TL can be provided by the actual value of another already-programmed function. You can use the actual values of the following functions:

- Analog comparator (Page 163) (actual value Ax – Ay)
- Analog threshold trigger (Page 157) (actual value Ax)
- Analog amplifier (Page 170) (actual value Ax)
- Analog multiplexer (Page 190) (actual value AQ)
- Analog ramp (Page 192) (actual value AQ)
- Analog math (Page 204) (actual value AQ)
- PI controller (Page 196) (actual value AQ)
- Up/down counter (Page 147) (actual value Cnt)

Select the required function by the block number. The timebase is configurable. For information on valid ranges and parameter defaults, refer to the On-delay (Page 120) topic.

Timing diagram A

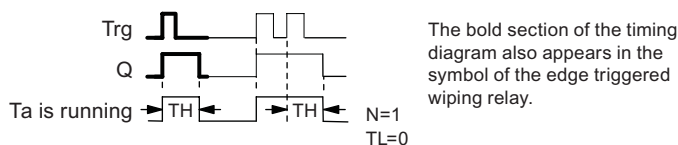

Timing diagram B

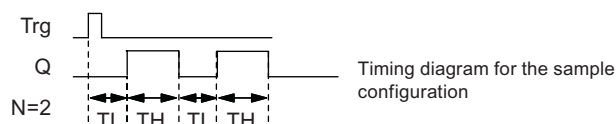

Functional description

A 0 to 1 transition at input Trg triggers the time T_L (Time Low). After the time T_L has expired, output Q is set for the duration of T_H (Time High).

If there is a further 0 to 1 transition (retriggering pulse) at input Trg before the preset time ($T_L + T_H$) has expired, T_a is reset and the pulse/pause cycle is restarted.

If retentivity is not set, output Q and the time are reset after a power failure.

Setting the Par parameter

View in programming mode (example):

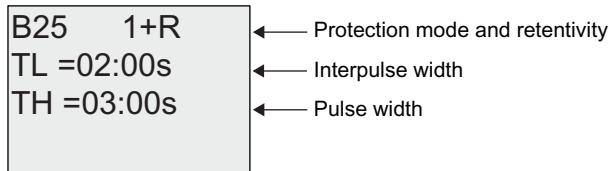

Press ►

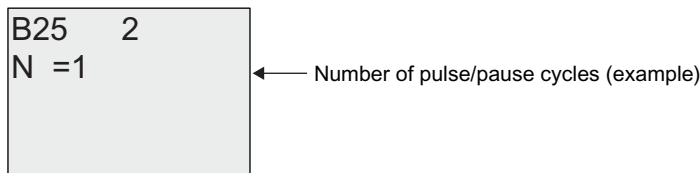

View in parameter assignment mode (example):

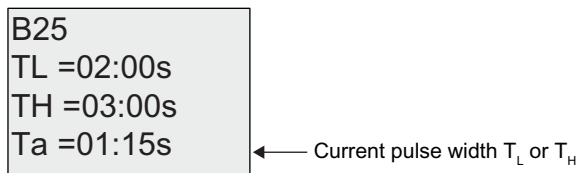

4.4.7 Asynchronous pulse generator

Short description

The output pulse shape can be modified by reconfiguring the pulse/pause ratio.

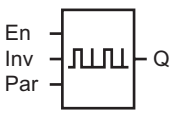
Symbol in LOGO!	Wiring	Description
	Input En	You can use input EN to set and reset the asynchronous pulse generator.
	Input INV	Input INV can be used to invert the output signal of the active asynchronous pulse generator.
	Parameter	You can configure the pulse width T_H and the interpulse width T_L . Retentivity: / = No retentivity R = The status is retentive.
	Output Q	Q is set and reset cyclically according to the pulse/pause ratio T_H and T_L .

Parameters TH and TL

Note the information on parameter T in topic Time response (Page 113)

The pulse width TH and the interpulse width TL can be provided by the actual value of another already-programmed function. You can use the actual values of the following functions:

- Analog comparator (Page 163) (actual value Ax – Ay)
- Analog threshold trigger (Page 157) (actual value Ax)
- Analog amplifier (Page 170) (actual value Ax)
- Analog multiplexer (Page 190) (actual value AQ)
- Analog ramp (Page 192) (actual value AQ)
- Analog math (Page 204) (actual value AQ)
- PI controller (Page 196) (actual value AQ)
- Up/down counter (Page 147) (actual value Cnt)

Select the required function by the block number. The timebase is configurable. For information on valid ranges and parameter defaults, refer to the On-delay (Page 120) topic.

Timing diagram

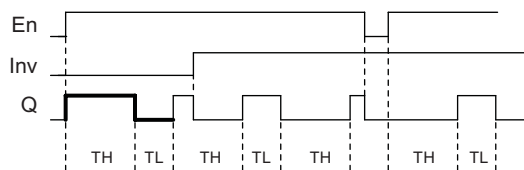

Functional description

You can configure the pulse/interpulse width at the TH (Time High) and TL (Time Low) parameters.

Input Inv can be used to invert the output signal, provided the block is enabled with a signal at input EN.

If retentivity is not set, output Q and the expired time are reset after a power failure.

4.4.8 Random generator

Short description

The output of the random generator is set or reset within a configured time.

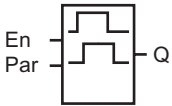
Symbol in LOGO!	Wiring	Description
	Input En	<p>A positive edge (0 to 1 transition) at input En (Enable) triggers the on-delay time of the random generator.</p> <p>A negative edge (1 to 0 transition) at input En (Enable) triggers the off-delay time of the random generator.</p>
	Parameter	<p>The on-delay is set at random to a value between 0 s and T_H.</p> <p>The off-delay is set at random to a value between 0 s and T_L.</p>
	Output Q	Output Q is set when the on-delay has expired and if En is still set. It is reset when the off-delay has expired, provided En was not set again meanwhile.

Parameter T_H and T_L

Note the defaults of the T_H and T_L parameters listed in topic Time response (Page 113).

The on-delay time T_H and the off-delay time T_L can be provided by the actual value of another already-programmed function. You can use the actual values of the following functions:

- Analog comparator (Page 163) (actual value $A_x - A_y$)
- Analog threshold trigger (Page 157) (actual value A_x)
- Analog amplifier (Page 170) (actual value A_x)
- Analog multiplexer (Page 190) (actual value A_Q)
- Analog ramp (Page 192) (actual value A_Q)
- Analog math (Page 204) (actual value A_Q)
- PI controller (Page 196) (actual value A_Q)
- Up/down counter (Page 147) (actual value Cnt)

Select the required function by the block number. The timebase is configurable. For information on valid ranges and parameter defaults, refer to the On-delay (Page 120) topic.

Timing diagram

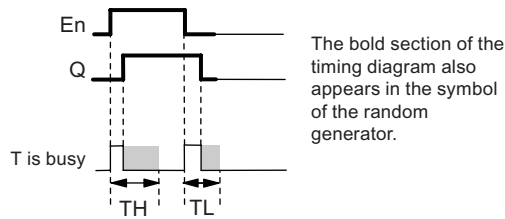

Functional description

The 0 to 1 transition at input En triggers a random on-delay time between 0 s and T_H . The output is set when the on-delay time has expired and if the signal at input En remains hi at least for the duration of this time.

The time is reset if input En is reset before the on-delay time has expired.

A 1 to 0 transition at input EN triggers a random off-delay time between 0 s and T_L .

The output is reset after the off-delay time has expired, provided input En remains lo at least for the duration of this time.

The time is reset if the signal at input En changes to 1 again before the off-delay time has expired.

The time expired is reset after a power failure.

4.4.9 Stairway lighting switch

Short description

An input edge triggers a configurable and retriggerable time. The output is reset after this time has expired. A warning signal can be output before this time has expired to warn of the impending shutdown.

Symbol in LOGO!	Wiring	Description
	Input Trg	A signal at input Trg (Trigger) triggers the off-delay time for the stairway lighting switch.
	Parameter	T represents the off-delay time of the output (output signal transition 1 to 0). T_I determines the triggering time for the pre-warning. T_{IL} determines the length of the pre-warning signal. Retentivity: / = No retentivity R = The status is retentive.
	Output Q	Q is reset after the time T has expired. A warning signal can be output before this time has expired.

Parameter T, T_I and T_{IL}

Note the defaults of the T parameters listed in topic Time response (Page 113).

The off-delay time T, the pre-warning time T_I and the pre-warning period T_{IL} can be provided by the actual value of another already-programmed function. You can use the actual values of the following functions:

- Analog comparator (Page 163) (actual value Ax – Ay)
- Analog threshold trigger (Page 157) (actual value Ax)
- Analog amplifier (Page 170) (actual value Ax)
- Analog multiplexer (Page 190) (actual value AQ)
- Analog ramp (Page 192) (actual value AQ)
- Analog math (Page 204) (actual value AQ)
- PI controller (Page 196) (actual value AQ)
- Up/down counter (Page 147) (actual value Cnt)

Select the required function by the block number. The timebase is configurable. For information on valid ranges and parameter defaults, refer to the On-delay (Page 120) topic.

Timing diagram

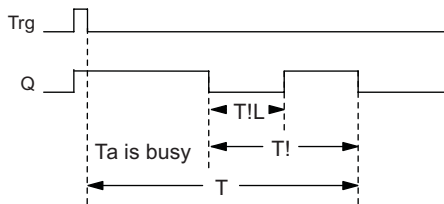

Functional description

A 0 to 1 signal transition at input Trg sets output Q. The next 1 to 0 transition at Trg retriggers the current time T_a, and output Q remains set.

Output Q is reset when T_a = T. You can output a warning signal before the off-delay time (T - T_I) has expired to reset Q for the time of the pre-warning period T_{IL}.

A further one-shot at input Trg during T_a retriggers the time T_a.

If retentivity is not set, output Q and the expired time are reset after a power failure.

Setting the Par parameter

Note the defaults specified in topic Time response (Page 113).

Note

All times must have the same timebase.

View in programming mode (example):

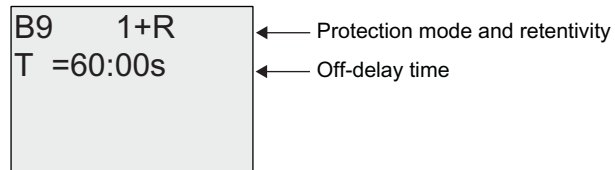

Press ►

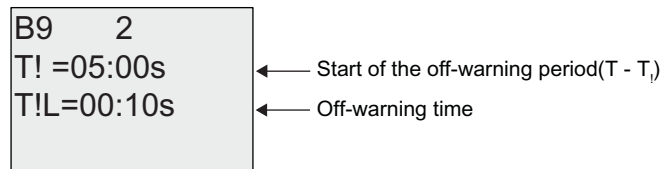

View in parameter assignment mode (example):

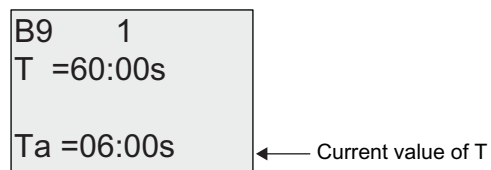

4.4.10 Multiple function switch

Short description

Switch with two different functions:

- Pulse switch with off-delay
- Switch (permanent lighting)

Symbol in LOGO!	Wiring	Description
	Input Trg	A signal at input Trg (Trigger) sets output Q (permanent light) or resets Q with an off-delay. When active, output Q can be reset with a signal at input Trg.
	Input R	A signal at input R resets the current time T_a and resets the output.
	Parameter	<p>T represents the off-delay time. The output is reset (1 to 0 transition) when time T expires.</p> <p>T_L represents the time during which the output must be set to enable the permanent light function.</p> <p>T_I represents the on-delay for the prewarning time.</p> <p>T_{IL} represents the length of the prewarning time period.</p> <p>Retentivity: / = No retentivity R = The status is retentive.</p>
	Output Q	A signal at Trg switches on output Q. Depending on the length of the input at Trg, the output is switched off again or switched on permanently, or it is reset with a further signal at Trg.

Parameters T, T_L , T_I and T_{IL}

Note the defaults of the T parameters listed in topic Time response (Page 113).

The off-delay time T, the permanent light time T_L , the on-delay prewarning time T_I and the prewarning time period T_{IL} can be provided by the actual value of another already-programmed function. You can use the actual values of the following functions:

- Analog comparator (Page 163) (actual value $A_x - A_y$)
- Analog threshold trigger (Page 157) (actual value A_x)
- Analog amplifier (Page 170) (actual value A_x)
- Analog multiplexer (Page 190) (actual value A_Q)
- Analog ramp (Page 192) (actual value A_Q)
- Analog math (Page 204) (actual value A_Q)
- PI controller (Page 196) (actual value A_Q)
- Up/down counter (Page 147) (actual value Cnt)

Select the required function by the block number. The timebase is configurable. For information on valid ranges and parameter defaults, refer to the On-delay (Page 120) topic.

Timing diagram

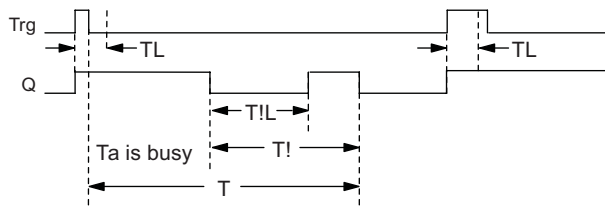

Functional description

A 0 to 1 transition at input Trg sets output Q.

If output Q = 0, and input Trg is set hi at least for the duration of T_L , the permanent lighting function is enabled and output Q is set accordingly.

The off-delay T is triggered when input Trg returns to 0 before T_L has expired.

Output Q is reset when $T_a = T$.

You can output an off-warning signal prior to the expiration of the off-delay time ($T - T!$) that resets Q for the duration of the prewarning time period $T_{!L}$. A subsequent signal at Trg always resets T and the output Q.

If retentivity is not set, output Q and the expired time are reset after a power failure.

Setting the Par parameter

Note the defaults specified in the topic "Time response (Page 113)".

Note

T , $T!$ and $T_{!L}$ must all have the same timebase.

View in programming mode (example):

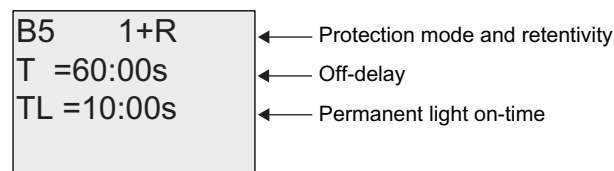

Press ►

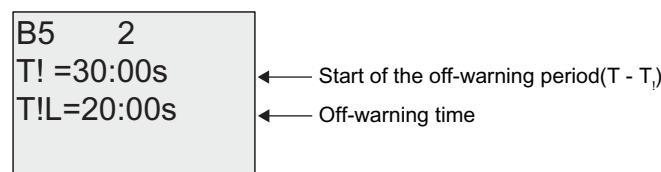

View in parameter assignment mode (example):

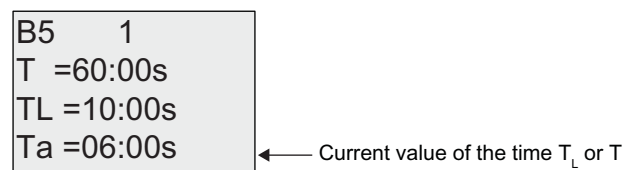

4.4.11 Weekly timer

Short description

The output is controlled by means of a configurable on/off date. The function supports any combination of weekdays. You select the active weekdays by hiding the inactive days.

Note

Because LOGO! 24/24o does not have a real-time clock, the weekly timer function is not available for this version.

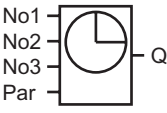
Symbol in LOGO!	Wiring	Description
	Cam parameters 1, 2, and 3	At the Cam parameters, you set the on- and off-times of the weekly timer for each Cam switch. Here you also configure the days and the time-of-day.
	Par	You specify whether the timer pulses on for one cycle when activated and then reset. The pulse setting applies to all three cams.
	Output Q	Q is set when the configured cam is actuated.

Timing diagram (three examples)

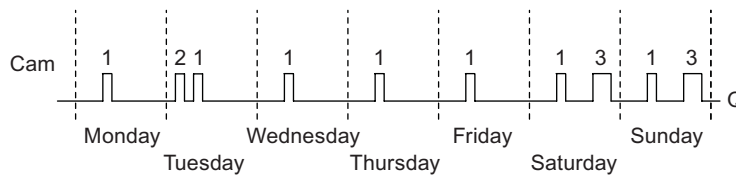

Cam 1:	Daily:	06:30 h to 8:00 h
Cam 2:	Tuesday:	03:10 h to 04:15 h
Cam 3:	Saturday and Sunday:	16:30 h to 23:10 h

Functional description

Each weekly timer has three cams you can use to configure a time hysteresis. You specify the on- and off-times at the Cam parameters. The weekly timer sets the output at a certain on-time, if this is not already set.

The weekly timer resets the output at a certain off-time if you configured an off-time, or at the end of the cycle if you specified a pulse output. You will cause a conflict if the on- and off-times you set for the weekly timer are identical, though set on different cams. In this case, cam3 takes priority over cam2, whereas cam2 takes priority over cam1.

The switching state of the weekly timer is determined by the status of all three cams.

Parameter assignment screen form

View of the parameter assignment screen form, for example for Cam1 and the Pulse setting:

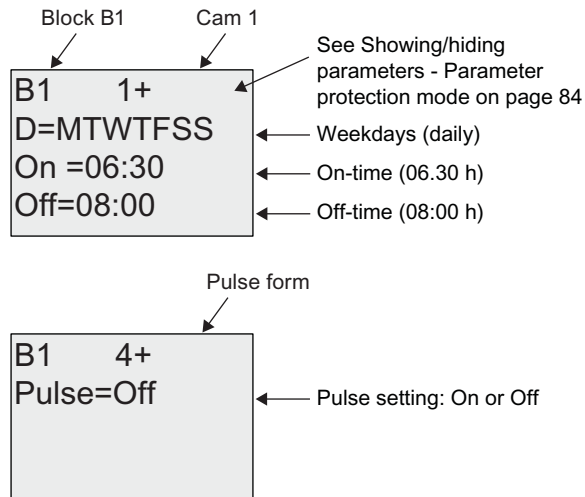

Days of the week

The prefix "D=" (Day) has the following meaning:

- M: Monday
- T: Tuesday
- W: Wednesday
- T: Thursday
- F: Friday
- S: Saturday
- S: Sunday

Uppercase letters indicate a specific day of the week. A "-" indicates no selection for the day of the week.

On-/Off-times

Any time between 00:00 h and 23:59 h is possible. You can also configure the on time to be a pulse signal. The timer block will be activated at the specified time for one cycle and then the output is reset.

--:- means: No on-/off-times set.

Setting the weekly timer

To set the on-/off-times:

1. Move the cursor to one of the Cam parameters of the timer (e.g. No1).
2. Press **OK**. LOGO! opens the Cam parameter assignment screen form. The cursor is positioned on the day of the week.
3. Press **▲** and **▼** to select one or several days of the week.
4. Press **▶** to move the cursor to the first position of the on-time.
5. Set the on-time.
Modify the value at the respective position, using the keys **▲** and **▼**. Move to the cursor to the various positions, using the keys **◀** and **▶**. At the first position, you can only select the value -:- -
(-:- - means: No on-/off-times set).
6. Press **▶** to move the cursor to the first position of the off-time.
7. Set the off-time (in same way as in step 5).
8. Confirm your entries with **OK**.

The cursor is now positioned on the No2 parameter (Cam2) and you can configure a further cam.

Note

For information on timer accuracy, refer to the technical data and to the topic "Time response (Page 113)".

Weekly timer: Example

The output of the weekly timer switch is to be set daily from 06:30 h to 08:00 h. The output should also be set every Tuesday from 03:10 h to 04:15 h, and on the weekends from 16:30 h to 23:10 h.

This requires three cams.

Here are the parameter assignment screen forms of the cams No 1, 2 and 3, based on the timing diagram shown earlier.

Cam1

Cam No1 must set the output of the weekly timer daily from 06:30 h to 08:00 h.

```
B1    1+
D=MTWTFSS
On =06:30
Off=08:00
```

Cam2

Cam No2 must set the output of the weekly timer every Tuesday from 03:10 h to 04:15 h.

```
B1    2
D=-T-----
On =03:10
Off=04:15
```

Cam3

Cam No3 must set the output of the weekly timer switch every Saturday and Sunday from 16:30 h to 23:10 h.

```
B1    3
D=-----SS
On =16:30
Off=23:10
```

Result

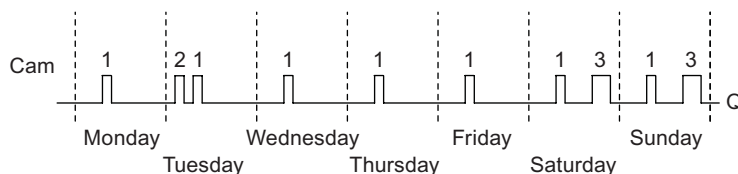

4.4.12 Yearly timer

Short description

The output is controlled by means of a configurable on/off date. You can configure the timer to activate on a yearly, monthly, or user-defined time basis. With any mode, you can also configure the timer to pulse the output during the defined time period. The time period is configurable within the date range of January 1, 2000 to December 31, 2099.

Note

Because LOGO! 24/24o does not have a real-time clock, the yearly timer is not available for this version.

Symbol in LOGO!	Wiring	Description
	Cam parameter	At the Cam parameter, you configure the timer mode, the on-/off-times for the timer, and whether the output is a pulse output.
	Output Q	Q is set when the configured cam is switched on.

Timing diagrams

Example 1: Yearly mode on, Monthly mode off, Pulse Off, On Time = 2000-06-01, Off Time = 2099-08-31: Every year on June 1 the timer output switches on and remains on until August 31.

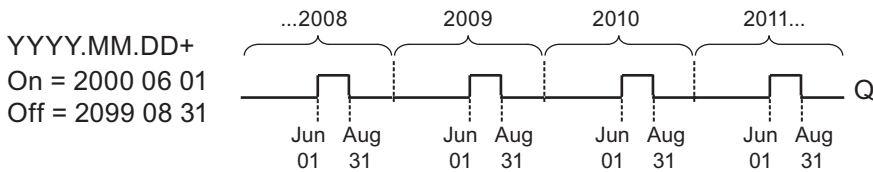

B6 1+
 Yearly = On
 Monthly = Off
 Pulse = Off

B6 2+
 ON :
 YYYY-MM-DD
 2000-06-01

B6 3+
 OFF :
 YYYY-MM-DD
 2099-08-31

Example 2: Yearly mode on, Monthly mode off, Pulse on, On Time = 2000-03-15, Off Time = 2099-**-**: Every year on March 15, the timer switches on for one cycle.

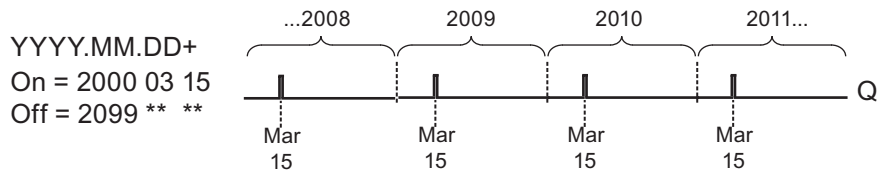

B6 1+
Yearly = On
Monthly = Off
Pulse = On

B6 2+
ON :
YYYY-MM-DD
2000-03-15

B6 3+
OFF :
YYYY-MM-DD
2099-**-**

Example 3: Yearly mode on, Monthly mode off, Pulse off, On Time = 2008-06-01, Off Time = 2010-08-31: On June 1 of 2008, 2009, and 2010 the timer output switches on and remains on until August 31.

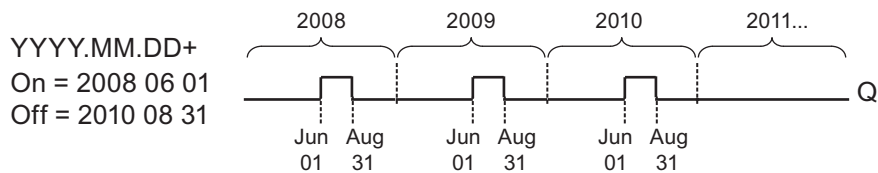

B6 1+
Yearly = On
Monthly = Off
Pulse = Off

B6 2+
ON :
YYYY-MM-DD
2008-06-01

B6 3+
OFF :
YYYY-MM-DD
2010-08-31

Example 4: Yearly mode on, Monthly mode off, Pulse on, On Time = 2008-03-15, Off Time = 2010-**-**: On March 15 of 2008, 2009, and 2010, the timer output switches on for one cycle.

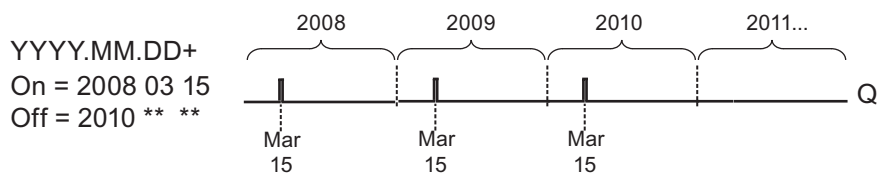

B6 1+
Yearly = On
Monthly = Off
Pulse = On

B6 2+
ON :
YYYY-MM-DD
2008-03-15

B6 3+
OFF :
YYYY-MM-DD
2010-**-**

Example 5: Yearly mode off, Monthly mode off, Pulse off, On Time = 2008-06-01, Off Time = 2008-08-31: On June 1, 2008 the timer output switches on and remains on until August 31, 2010.

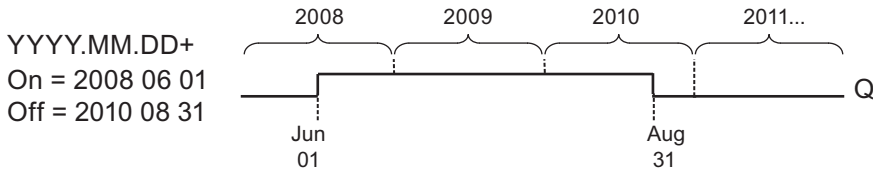

YYYY.MM.DD+
On = 2008 06 01
Off = 2010 08 31

B6 1+
Yearly = Off
Monthly = Off
Pulse = Off

B6 2+
ON :
YYYY-MM-DD
2008-06-01

B6 3+
OFF :
YYYY-MM-DD
2010-08-31

Example 6: Yearly mode off, Monthly mode off, Pulse selected, On Time = 2008-03-15, Off Time = ****_*_*_*_*: On March 15, 2008 the timer output switches on for one cycle. Because the timer does not have a monthly action or yearly action, the timer output pulses only one time at the specified On Time.

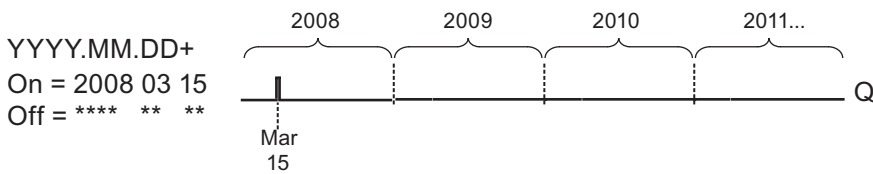

YYYY.MM.DD+
On = 2008 03 15
Off = **** *_*_*_*

B6 1+
Yearly = Off
Monthly = Off
Pulse = On

B6 2+
ON :
YYYY-MM-DD
2008-03-15

B6 3+
OFF :
YYYY-MM-DD
****_*_*_*_*

Example 7: Yearly mode on, Monthly mode off, Pulse off, On Time = 2008-12-15, Off Time = 2010-01-07: On December 15 of 2008 and 2009, the timer output switches on and remains on until January 7 of the following year. When the timer output turns off on January 7, 2010 it does NOT turn on again the following December 15.

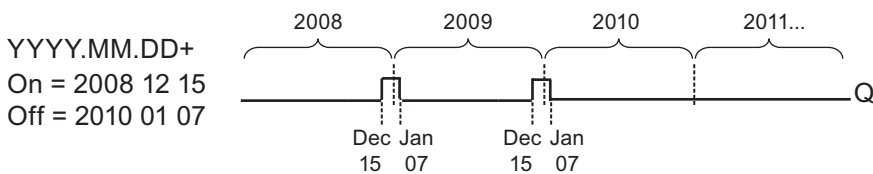

YYYY.MM.DD+
On = 2008 12 15
Off = 2010 01 07

B6 1+
Yearly = On
Monthly = Off
Pulse = Off

B6 2+
ON :
YYYY-MM-DD
2008-12-15

B6 3+
OFF :
YYYY-MM-DD
2010-01-07

Example 8: Yearly mode on, Monthly mode on, On Time = 2008-**-01, Off Time = 2010-**-05: Starting in 2008, on the first day of each month the timer output switches on and switches off on the fifth day of the month. The timer continues in this pattern through the last month of 2010.

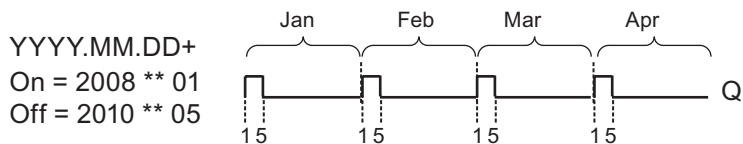

B6	1+
Yearly = On	
Monthly = On	
Pulse = Off	

B6	2+
ON :	
YYYY-MM-DD	
2008-**-01	

B6	3+
OFF :	
YYYY-MM-DD	
2010-**-05	

Functional description

The yearly timer sets and resets the output at specific on and off dates. Sets and resets are executed at 00:00. If your application requires a different time, use a weekly timer together with a yearly timer in your circuit program.

The on time specifies when the timer is activated. The off time specifies when the output is reset again. For the on and off times, note the order of the fields: The first field defines the year, the second the month and the third the day.

If you set the Monthly mode on, the timer output switches on each month at the specified day of the on time and remains on until the specified day of the off time. The on time specifies the initial year in which the timer is activated. The off time defines the last year in which the timer turns off. The maximum year is 2099.

If you set the Yearly mode on, the timer output switches on each year at the specified month and day of the on time and remains on until the specified month and day of the off time. The on time specifies the initial year in which the timer is activated. The off time defines the last year in which the timer turns off. The maximum year is 2099.

If you set Pulse output, the timer output switches on at the specified on time for one cycle and then the timer output is reset. You can choose to pulse a timer on a monthly or yearly basis, or just a single time.

If you set none of the Monthly, Yearly, or Pulse modes on, you can define a specific time period with the on time and off time. It can span any time period that you choose.

For a process action that is to be switched on and off at multiple but irregular times during the year, you can define multiple yearly timers with the outputs connected by an OR function block.

Backup of the real-time clock

The internal real-time clock of LOGO! is buffered against power failure. The buffering time is influenced by the ambient temperature, and is typically 80 hours at an ambient temperature of 25°C. If you are using the optional LOGO! Battery card, or combined LOGO! Memory/Battery card, LOGO! can retain the clock time for up to two years.

Sample configuration

The output of a LOGO! is to be set annually on March 1, reset on April 4, set again on July 7, and reset again on November 19. You need to configure two yearly timers with corresponding on-times. Then logically link the outputs by means of an OR block.

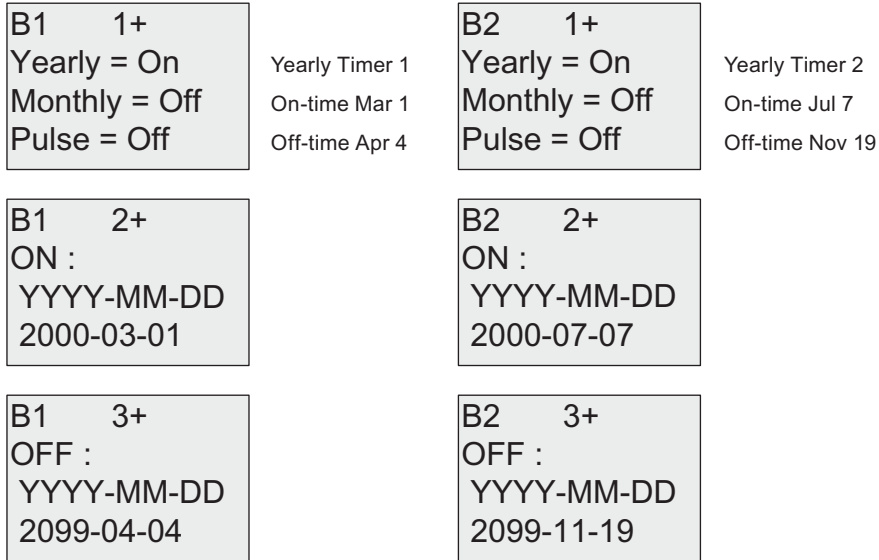

Result

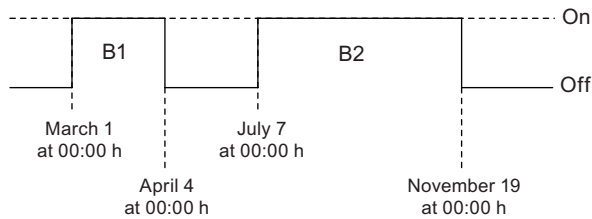

4.4.13 Up/down counter

Short description

An input pulse increments or decrements an internal value, depending on the parameter setting. The output is set or reset when a configured threshold is reached. The direction of count can be changed with a signal at input Dir.

Symbol in LOGO!	Wiring	Description
	Input R	A signal at input R resets the internal count value to zero.
	Input Cnt	The function counts the 0 to 1 transitions at input Cnt. 1 to 0 transitions are not counted. Use <ul style="list-style-type: none"> inputs I3, I4, I5, and I6 for fast counting (only LOGO! 12/24 RC/RCo and LOGO! 24/24o): max. 5 kHz. any other input or circuit component for counting low frequency signals (typ. 4 Hz).
	Input Dir	You set the direction of count at input Dir: Dir = 0: Up count Dir = 1: Down count
	Parameter	On: On threshold Range of values: 0...999999 Off: Off threshold Range of values: 0...999999 StartVal: Initial value from which to begin counting either down or up. Retentivity for internal counter value Cnt: / = No retentivity R = The status is retentive.
	Output Q	Q is set or reset, depending on the current value at Cnt and the set thresholds.

Parameters On and Off

The on threshold On and the off threshold Off can be provided by the actual value of another already-programmed function. You can use the actual values of the following functions:

- Analog comparator (Page 163) (actual value Ax – Ay)
- Analog threshold trigger (Page 157) (actual value Ax)
- Analog amplifier (Page 170) (actual value Ax)
- Analog multiplexer (Page 190) (actual value AQ)
- Analog ramp (Page 192) (actual value AQ)
- Analog math (Page 204) (actual value AQ)
- PI controller (Page 196) (actual value AQ)
- Up/down counter (actual value Cnt)

Select the required function by the block number.

Timing diagram

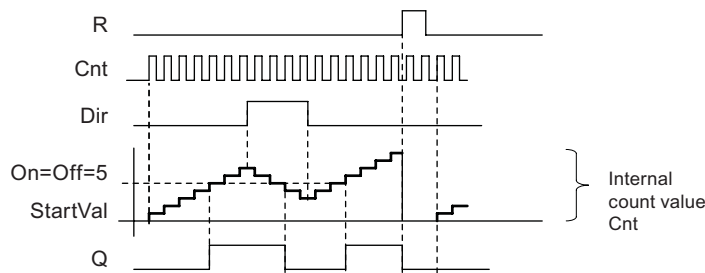

Functional description

The internal counter increments (Dir = 0) or decrements (Dir = 1) by one count with every positive edge at input Cnt.

You can use input R to reset the internal count value to the start value. As long as R = 1, the output is also 0 and the pulses at input Cnt are not counted.

If retentivity is not set, output Q and the expired time are reset after a power failure.

Q is set or reset depending on the current value at Cnt and the set thresholds. See the calculation rule below.

Calculation rule

- If the On threshold \geq Off threshold, then:
Q = 1, if Cnt \geq On
Q = 0, if Cnt < Off
- If the On threshold < Off threshold, then Q = 1, if On \leq Cnt \leq Off.

Note

The system scans the counter limit value cyclically.

Thus, if the pulse frequency at the fast digital inputs I3, I4, I5 or I6 is faster than the cycle time, the special function might not switch until after the specified limit value is exceeded.

Example: Up to 100 pulses per cycle can be counted; 900 pulses have been counted so far. On = 950; Off = 10000. The output is set in the next cycle, after the value has reached 1000. (The output would not be set at all if the value Off = 980).

View in programming mode (example):

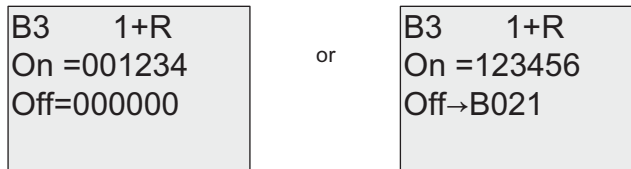

To set the start value, press ▲ or ▼ to access the following screen form:

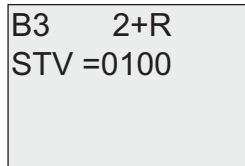

If the referenced block (B021, in the example) returns a value that lies out of the valid range, the value is rounded to the next valid value.

The view in parameter assignment mode (example):

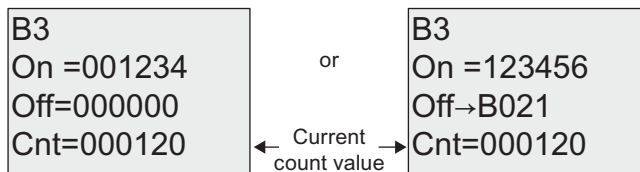

4.4.14 Hours counter

Short description

A configured time is triggered with a signal at the monitoring input. The output is set when this time has expired.

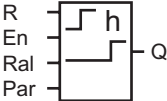
Symbol in LOGO!	Wiring	Description
	Input R	A positive edge (0 to 1 transition) at input R resets output Q and sets a configured value MI at the counter for the duration of the time-to-go (MN).
	Input En	En is the monitoring input. LOGO! scans the on-time of this input.
	Input Ral	A positive edge at input Ral (Reset all) resets the hours counter (OT) and the output, and sets the time-to-go value (MN) to the maintenance interval MI: <ul style="list-style-type: none"> • Output Q = 0 • Measured operating time OT = 0 • Time-to-go of the maintenance interval MN = MI.
	Parameter	MI: Maintenance interval to be preset in units of hours and minutes Range of values: 0000...9999 h, 0...59 m OT: The accumulated total operating time; you can specify an offset in hours and minutes Range of values: 00000...99999 h, 0...59 m Q → 0: <ul style="list-style-type: none"> • When "R" is selected: Q = 1, if MN = 0; Q = 0, if R = 1 or Ral = 1 • When "R+En" is selected: Q = 1, if MN = 0; Q = 0, if R = 1 or Ral = 1 or En = 0.
	Output Q	The output is set when the time-to-go MN = 0 (see timing diagram). The output is reset: <ul style="list-style-type: none"> • When "Q→0:R+En", if R = 1 or Ral = 1 or En = 0 • When "Q→:R", if R = 1 or Ral = 1.

MI = Configured time interval

MN = Time-to-go

OT = Total time expired since the last hi signal at input Ral

These values are always retentive!

Parameter MI

The maintenance interval MI can be provided by the actual value of another already-programmed function. You can use the actual values of the following functions:

- Analog comparator (Page 163) (actual value Ax – Ay)
- Analog threshold trigger (Page 157) (actual value Ax)
- Analog amplifier (Page 170) (actual value Ax)
- Analog multiplexer (Page 190) (actual value AQ)
- Analog ramp (Page 192) (actual value AQ)
- Analog math (Page 204) (actual value AQ)
- PI controller (Page 196) (actual value AQ)
- Up/down counter (Page 147) (actual value Cnt)

Select the required function by the block number.

Timing diagram

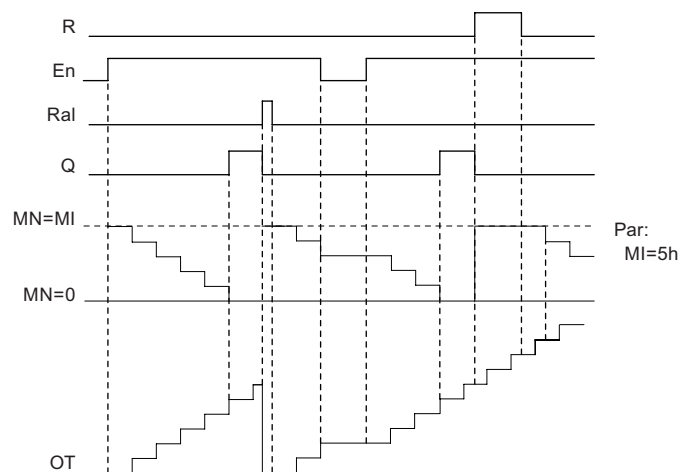

MI = Configured time interval
MN = Time-to-go
OT = Total time expired since the last hi signal at input Ral

Functional description

The hours counter monitors input En. When En = 1, LOGO! computes the time expired and the time-to-go MN. LOGO! shows these times in parameter assignment mode. Output Q is set when the time-to-go MN = 0.

A signal at reset input R resets output Q and sets the preset value of MI at the counter for the duration of MN. The hours counter OT is not affected.

With a signal at the reset input Ral, you reset output Q and set the preset value of MI at the counter for the duration of MN. The hours counter OT is reset to zero.

Depending on your configuration of parameter Q, the output is either reset with a signal at input R or Ral ("Q→0:R"), or when a reset signal is set hi, or the En signal is set lo ("Q→0:R+En").

Viewing the MI, MN and OT values

- LOGO! Basic with display unit: You can open the parameter assignment mode when the system is in RUN to view the actual values of MI, MN and OT.
- LOGO! Basic without display unit: In LOGO!Soft Comfort, you can use the Online Test to read these values. For further information, see chapter "LOGO! software (Page 233)".
- In LOGO!Soft Comfort you can get the hours counter via the "Tools -> Transfer: Hours counter" menu command.

Limit value of OT

The value of the operating hours in OT is retained when you reset the hours counter with a signal at input R. The hours counter OT will be reset to zero with a transition from 0 to 1 at Ral. The hours counter OT continues the count as long as En = 1, irrespective of the status at the reset input R. The counter limit of OT is 99999 h. The hours counter stops when it reaches this value.

In programming mode, you can set the initial value of OT. MN is calculated according to the following formula when reset input R is never enabled: $MN = MI - (OT \% MI)$. The % operator provides an integer division remainder.

Example:

$MI = 30h, OT = 100h$

$MN = 30 - (100 \% 30)$

$MN = 30 - 10$

$MN = 20h$

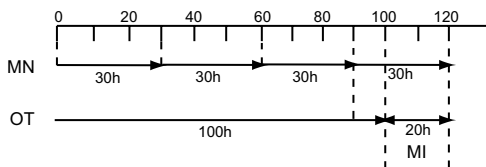

In runtime mode, the value OT can not be preset. If the value for MI is changed, there would be no calculation for the MN. MN would take on the value of MI.

Setting the Par parameter

View in programming mode:

```
B16  1+R
MI = 0100h
    00 m
```

```
B16  1+R
MI→ B001h
```

```
B16  2+R
OT =00030h
    00 m
```

```
B16  3+R
Q→0:R+En
```

MI is the configurable time interval. The permissible range of values is 0 to 9999 hours.

For information on how to assign the actual value of another already-programmed function to a parameter, see the On-delay (Page 120) topic.

View in parameter assignment mode:

```
B16  1
MI = 0100h
    00 m
```

← Time interval

```
B16  2
OT =00083h
    15 m
```

← Total operating hours

```
B16  3
MN = 0016h
    45 m
```

← Time-to-go

4.4.15 Threshold trigger

Short description

The output is set and reset with two configurable threshold triggers.

Symbol in LOGO!	Wiring	Description
	Input Fre	The function counts the 0 to 1 transitions at input Fre. 1 to 0 transitions are not counted. Use <ul style="list-style-type: none"> inputs I3, I4, I5, I6 for fast counting (only LOGO! 12/24 RC/RCo and LOGO! 24/24o): max. 5 kHz. any other input or circuit component for counting low frequency signals (typ. 4 Hz).
	Parameter	On: On threshold Range of values: 0000...9999 Off: Off threshold Range of values: 0000...9999 G_T: Time interval or gate time during which the input pulses are measured. Range of values: 00:05 s...99:99 s
	Output Q	Q is set and reset at the thresholds.

Parameter G_T

The gate time G_T can be provided by the actual value of another already-programmed function. You can use the actual values of the following functions:

- Analog comparator (Page 163) (actual value Ax – Ay)
- Analog threshold trigger (Page 157) (actual value Ax)
- Analog amplifier (Page 170) (actual value Ax)
- Analog multiplexer (Page 190) (actual value AQ)
- Analog ramp (Page 192) (actual value AQ)
- Analog math (Page 204) (actual value AQ)
- PI controller (Page 196) (actual value AQ)
- Up/down counter (Page 147) (actual value Cnt)

Select the required function by the block number.

Timing diagram

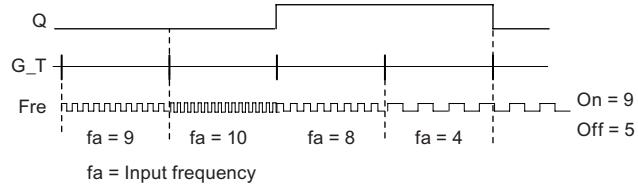

Functional description

The threshold trigger measures the signals at input Fre. The pulses are recorded across a configurable time G_T .

Output Q is set and reset in accordance with the set thresholds. See the calculation rule below.

Calculation rule

- If the On threshold \geq Off threshold, then:
Q = 1, if $f_a > \text{On}$
Q = 0, if $f_a \leq \text{Off}$.
- If the On threshold $<$ Off threshold, then Q = 1 if
 $\text{On} \leq f_a < \text{Off}$.

Setting the Par parameter

Note

The system scans the counter limit value once per interval G_T.

View in programming mode (example):

B15 1+ On =0009 Off=0005	← Parameter protection mode
	← On threshold
	← Off threshold

Press ►

B15 2 G_T=01:00s	← Time interval for pulses (example)
---------------------	--------------------------------------

Note

The "seconds" timebase is here set as permanent default.

When you preset a time G_T of 1 s, LOGO! returns the current frequency in parameter f_a in Hz.

View in parameter assignment mode (example):

B15 On =0009 Off=0005 fa =0010	← On threshold
	← Off threshold
	← Q = 1 (f _a > On)

Note

f_a always represents the total pulses measured per time unit G_T.

4.4.16 Analog threshold trigger

Short description

The output is set and reset at two configurable thresholds.

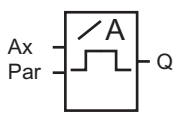
Symbol in LOGO!	Wiring	Description
	Input Ax	<p>You apply the analog signal to be analyzed at input Ax.</p> <p>Use the analog inputs AI1...AI8 (*), the analog flags AM1...AM6, the block number of a function with analog output, or the analog outputs AQ1 and AQ2.</p>
	Parameter	<p>A: Gain Range of values: ±10,00</p> <p>B: Zero offset Range of values: ±10,000</p> <p>On: On threshold Range of values: ±20,000</p> <p>Off: Off threshold Range of values: ±20,000</p> <p>p: Number of decimals Range of values: 0, 1, 2, 3</p>
	Output Q	Q is set or reset by the threshold triggers.
<p>* AI1...AI8: 0...10 V corresponds with 0...1000 (internal value).</p>		

Gain and offset parameters

Please note the information on gain and offset parameters in topic "Calculating the gain and offset of analog values (Page 115)".

Parameters On and Off

The On and Off parameters can be provided by the actual value of another already-programmed function. You can use the actual values of the following functions:

- Analog comparator (Page 163) (actual value Ax – Ay)
- Analog threshold trigger (actual value Ax)
- Analog amplifier (Page 170) (actual value Ax)
- Analog multiplexer (Page 190) (actual value AQ)
- Analog ramp (Page 192) (actual value AQ)
- Analog math (Page 204) (actual value AQ)
- PI controller (Page 196) (actual value AQ)
- Up/down counter (Page 147) (actual value Cnt)

Select the required function by the block number.

Parameter p (number of decimals)

Does not apply to the display of On, Off and Ax values in a message text.
Does not apply to the comparison of On and Off values! (The compare function ignores the decimal point.)

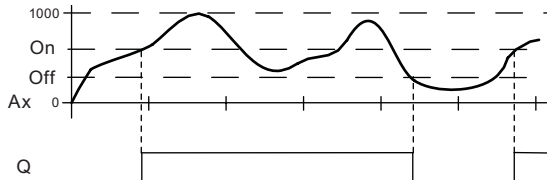
Timing diagram**Functional description**

The function fetches the analog signal at input Ax.

Ax is multiplied by the value of the A (gain) parameter, and the value at parameter B (offset) is added to product, i.e. $(Ax \cdot \text{gain}) + \text{offset} = \text{actual value of Ax}$.

Output Q is set or reset, depending on the set thresholds. See the calculation rule below.

Calculation rule

- If the On threshold \geq Off threshold, then:
Q = 1, if the actual value $Ax > \text{On}$
Q = 0, if the actual value $Ax \leq \text{Off}$.
- If the On threshold $<$ Off threshold, then Q = 1 if
 $\text{On} \leq \text{actual value } Ax < \text{Off}$.

Setting the Par parameter

The gain and offset parameters are used to adapt the sensors to the relevant application.

View in programming mode (example):

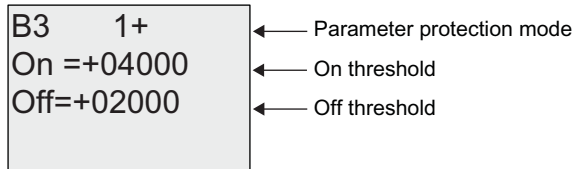

Press ►

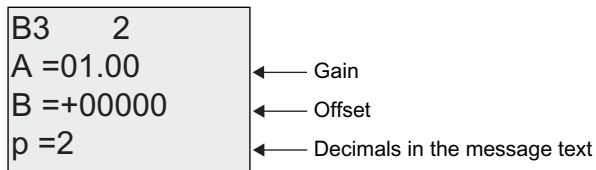

View in parameter assignment mode (example):

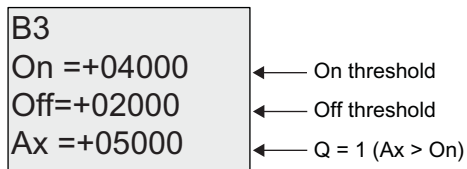

View in the message text (example):

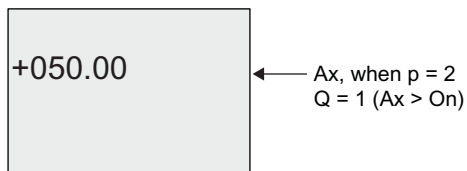

4.4.17 Analog differential trigger

Short description

The output is set and reset depending on a configurable threshold and a differential value.

Symbol in LOGO!	Wiring	Description
	Input Ax	<p>You apply the analog signal to be analyzed at input Ax.</p> <p>Use the analog inputs AI1...AI8 (*), the analog flags AM1...AM6, the block number of a function with analog output, or the analog outputs AQ1 and AQ2.</p>
	Parameter	<p>A: Gain Range of values: ±10.00</p> <p>B: Zero offset Range of values: ±10,000</p> <p>On: On/Off threshold Range of values: ±20,000</p> <p>Δ: Differential value for calculating the off parameter Range of values: ±20,000</p> <p>p: Number of decimals Range of values: 0, 1, 2, 3</p>
	Output Q	Q is set or reset, depending on the threshold and difference values.
<p>* AI1...AI8: 0...10 V corresponds with 0...1000 (internal value).</p>		

Gain and offset parameters

Please note the information on gain and offset parameters in topic "Calculating the gain and offset of analog values (Page 115)".

Parameter p (number of decimals)

Does not apply to the display of On, Off and Ax values in a message text.

Timing diagram A: Function with negative difference Δ

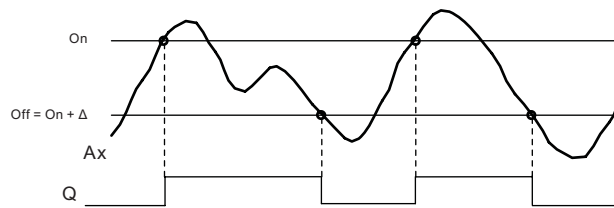

Timing diagram B: Function with positive difference Δ

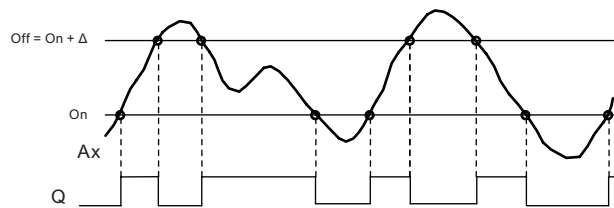

Functional description

The function fetches the analog signal at input Ax.

Ax is multiplied by the value of the A (gain) parameter, and the value at parameter B (offset) is added to product, i.e. $(Ax \cdot \text{gain}) + \text{offset} = \text{actual value of Ax}$.

Output Q is set or reset, depending on the set (On) threshold and difference value (Δ). The function automatically calculates the Off parameter: $\text{Off} = \text{On} + \Delta$, whereby Δ may be positive or negative. See the calculation rule below.

Calculation rule

- When you set a negative differential value Δ , the On threshold \geq Off threshold, and:
Q = 1, if the actual value $Ax > \text{On}$
Q = 0, if the actual value $Ax \leq \text{Off}$.
See the timing diagram A.
- When you set a positive differential value Δ , the On threshold $<$ the Off threshold, and Q = 1, if:
 $\text{On} \leq \text{actual value } Ax < \text{Off}$.
See the timing diagram B.

Setting the Par parameter

The gain and offset parameters are used to adapt the sensors to the relevant application.

View in programming mode (example):

B3 1+ On =+04000 Δ =-02000	← Parameter protection mode
	← On/off threshold
	← Differential value for the on/off threshold

Press ►

B3 2 A =01.00 B =+00000 p =2	← Gain
	← Offset
	← Decimals in the message text

View in parameter assignment mode (example):

B3 On =+04000 Δ =-02000 Ax =+05000	← On threshold
	← Differential value for the off threshold
	← $Q = 1 (A_x > On)$

Press ▼

B3 Off=+02000	← Off threshold
------------------	-----------------

4.4.18 Analog comparator

Short description

The output is set and reset depending on the difference $Ax - Ay$ and on two configurable thresholds.

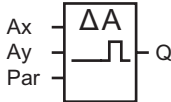
Symbol in LOGO!	Wiring	Description
	Inputs Ax and Ay	You apply the analog signals the difference of which you want to analyze at the inputs Ax and Ay. Use the analog inputs AI1...AI8 (*), the analog flags AM1...AM6, the block number of a function with analog output, or the analog outputs AQ1 and AQ2.
	Parameter	A: Gain Range of values: ± 10.00 B: Zero offset Range of values: $\pm 10,000$ On: On threshold Range of values: $\pm 20,000$ Off: Off threshold Range of values: $\pm 20,000$ p: Number of decimals Range of values: 0, 1, 2, 3
	Output Q	Q is set or reset, depending on the difference $Ax - Ay$ and the set thresholds..
* AI1...AI8: 0...10 V corresponds with 0...1000 (internal value).		

Gain and offset parameters

For more information on the gain and offset parameters, refer to topic "Calculating the gain and offset of analog values (Page 115)".

Parameters On and Off

The on threshold On and the off threshold Off can be provided by the actual value of another already-programmed function. You can use the actual values of the following functions:

- Analog comparator (actual value $Ax - Ay$)
- Analog threshold trigger (Page 157) (actual value Ax)
- Analog amplifier (Page 170) (actual value Ax)
- Analog multiplexer (Page 190) (actual value AQ)
- Analog ramp (Page 192) (actual value AQ)
- Analog math (Page 204) (actual value AQ)
- PI controller (Page 196) (actual value AQ)
- Up/down counter (Page 147) (actual value Cnt)

Select the required function by the block number.

Parameter p (number of decimals)

Does not apply to Ax, Ay, On, Off and Δ values displayed in a message text.
 Does not apply to the comparison of on and off values! (The compare function ignores the decimal point.)

Timing diagram

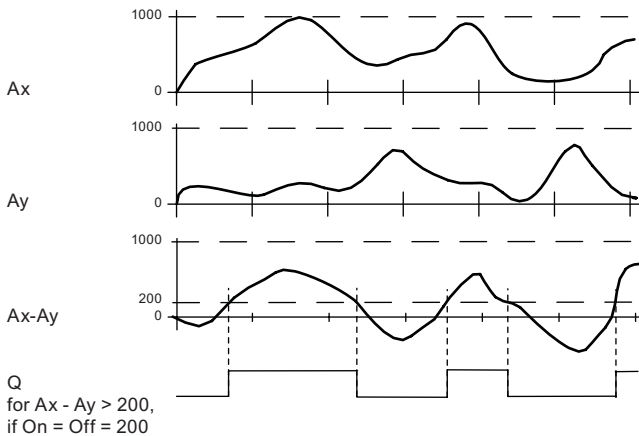

Functional description

The function fetches the analog values from the inputs Ax and Ay.

Ax and Ay are each multiplied by the value of the A (gain) parameter, and the value at parameter B (offset) is then added to the relevant product, i.e.

$$(Ax \cdot gain) + offset = \text{actual value Ax or}$$

$$(Ay \cdot gain) + offset = \text{actual value Ay.}$$

The function forms the difference ("Δ") between the actual values Ax - Ay.

Output Q is set or reset, depending on difference of the actual values Ax - Ay and the set thresholds. See the calculation rule below.

Calculation rule

- If the On threshold \geq Off threshold, then:
 Q = 1, if:
 $(\text{actual value Ax} - \text{actual value Ay}) > \text{On}$
 Q = 0, if:
 $(\text{actual value Ax} - \text{actual value Ay}) \leq \text{Off}.$
- If the On threshold $<$ Off threshold, then Q = 1, if:
 $\text{On} \leq (\text{actual value Ax} - \text{actual value Ay}) < \text{Off}.$

Setting the Par parameter

The gain and offset parameters are used to adapt the sensors to the relevant application.

View in programming mode:

B3 1+	← Parameter protection mode
On =+00000	← On threshold
Off=+00000	← Off threshold

Press ►

B3 2	
A =00.00	← Gain
B =+00000	← Offset
p =0	← Decimals in the message text

Example

In a heating control system, the supply T_v and return line temperatures T_r are to be compared, for example with a sensor at AI2.

A control signal is to be triggered (for example "heater On") when the difference between the supply and return line temperatures is greater than 15 °C. The control signal is reset when the difference is less than 5 °C.

The process variable of the temperature is to be shown in parameter assignment mode.

The thermocouples available have the following technical data: -30 to +70 °C, 0 to 10 VDC.

Application	Internal mapping
-30 to +70 °C = 0 to 10 V DC	0 to 1000
0 °C	300 → Offset = -30
Range of values: -30 to +70 °C = 100	1000 → Gain = 100/1000 = 0.1
On threshold = 15 °C	Threshold = 15
Off threshold = 5 °C	Threshold = 5
See also topic "Calculating the gain and offset of analog values (Page 115)".	

Configuration (example):

B3 1+	← Protection mode
On =+00015	← On threshold
Off=+00005	← Off threshold

Press ►

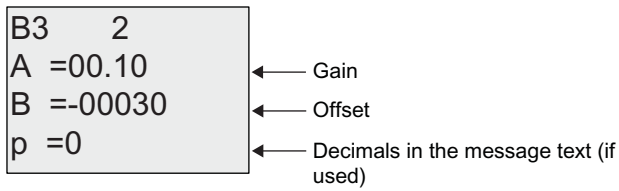

View in parameter assignment mode (example):

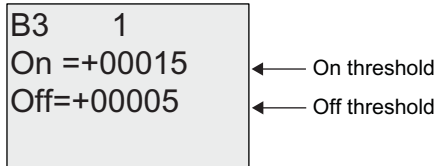

Press ▼

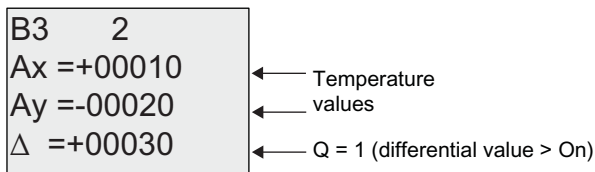

View in the message text (example):

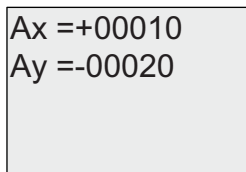

Reducing the input response of the analog comparator

You can selectively delay the output of an analog comparator by means of the "On-delay" and "Off-delay" special functions. With on-delay, output Q is only set if the pulse width of the triggering signal at input Trg (=analog comparator output) is longer than the on-delay time.

Using this method, you will obtain a virtual hysteresis and reduce the input response to short signals.

Function block diagram

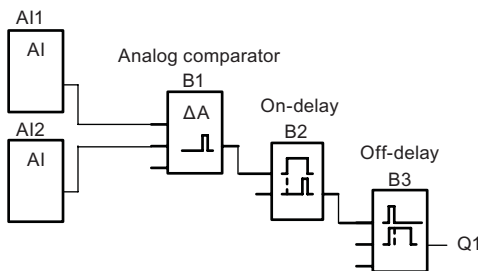

4.4.19 Analog watchdog

Short description

This special function saves the process variable of an analog input to memory, and sets the output when the output variable exceeds or drops below this stored value plus a configurable offset.

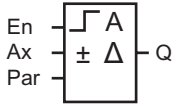
Symbol in LOGO!	Wiring	Description
	Input En	A positive edge (0 to 1 transition) at input En saves the analog value at input Ax ("Aen") to memory and starts monitoring of the analog range $Aen - \Delta_2$ to $Aen + \Delta_1$
	Input Ax	You apply the analog signal to be monitored at input Ax. Use the analog inputs AI1...AI8 (*), the analog flags AM1...AM6, the block number of a function with analog output, or the analog outputs AQ1 and AQ2.
	Parameter	A: Gain Range of values: ± 10.00 B: Zero offset Range of values: $\pm 10,000$ Δ_1 : Difference value above Aen: on/off threshold Range of values: 0-20,000 Δ_2 : Difference value below Aen: on/off threshold Range of values: 0-20,000 p: Number of decimals Range of values: 0, 1, 2, 3 Retentivity: / = No retentivity R = The status is retentive in memory
	Output Q	Q is set/reset, depending on the stored analog value and the offset.
* AI1...AI8: 0...10 V corresponds with 0...1000 (internal value).		

Gain and offset parameters

For more information on gain and offset parameters, refer to topic "Calculating the gain and offset of analog values (Page 115)".

Parameters Delta1 and Delta2

The Delta1 and Delta2 parameters can be provided by the actual value of another already-programmed function. You can use the actual value of the following functions:

- Analog comparator (Page 163) (actual value Ax – Ay)
- Analog threshold trigger (Page 157) (actual value Ax)
- Analog amplifier (Page 170) (actual value Ax)
- Analog multiplexer (Page 190) (actual value AQ)
- Analog ramp (Page 192) (actual value AQ)
- Analog math (Page 204) (actual value AQ)
- PI controller (Page 196) (actual value AQ)
- Up/down counter (Page 147) (actual value Cnt)

Select the required function by the block number.

Parameter p (number of decimals)

Applies only to the Aen, Ax, Δ₁ and Δ₂ values displayed in a message text.

Timing diagram

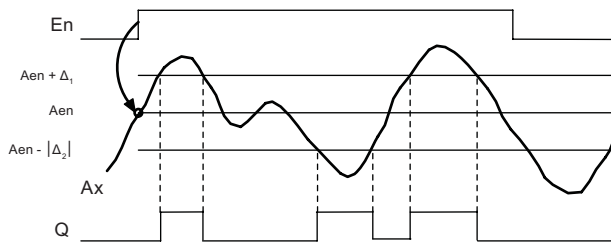

Functional description

A 0 to 1 transition at input En saves the value of the signal at the analog input Ax. This saved process variable is referred to as "Aen".

Both the analog actual values Ax and Aen are multiplied by the value at parameter A (gain), and parameter B (offset) is then added to the product:
 (Ax • gain) + offset = Actual value Aen, when input En changes from 0 to 1, or
 (Ax • gain) + offset = Actual value Ax.

Output Q is set when the signal at input En = 1 and if the actual value at input Ax is out of range of Aen - Δ₂ to Aen + Δ₁.

Output Q is reset, when the actual value at input Ax lies within the range of Aen - Δ₂ to Aen + Δ₁, or when the signal at input En changes to lo.

Setting the Par parameter

The gain and offset parameters are used to adapt the used sensors to the respective application.

View in programming mode:

B3	1+	← Parameter protection mode
$\Delta 1 = 00000$		← Differential value for the on/off threshold
$\Delta 2 = 00000$		

Press ►

B3	2	
A =00.00		← Gain
B =+00000		← Offset
p =0		← Decimals in the message text

View in parameter assignment mode (example):

B3		
$\Delta 1 = 00010$		
Aen=-00020		
Ax =+00005		← Q = 1 (Ax is out of the range of Aen - $\Delta 2$ to Aen + $\Delta 1$)

B3	
$\Delta 2 = 00010$	

4.4.20 Analog amplifier

Short description

This special function amplifies the value of an analog input and outputs the result at an analog output.

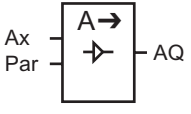
Symbol in LOGO!	Wiring	Description
	Input Ax	<p>You apply the analog signal to be amplified at input Ax.</p> <p>Use the analog inputs AI1...AI8 (*), the analog flags AM1...AM6, the block number of a function with analog output, or the analog outputs AQ1 and AQ2.</p>
	Parameter	<p>A: Gain Range of values: ±10.00</p> <p>B: Zero offset Range of values: ±10,000</p> <p>p: Number of decimals Range of values: 0, 1, 2, 3</p>
	Output AQ	<p>This special function has an analog output! This output can only be connected with the analog input of a function, an analog flag or an analog output connector (AQ1, AQ2).</p> <p>Range of values for AQ: -32767...+32767</p>
<p>* AI1...AI8: 0...10 V corresponds with 0...1000 (internal value).</p>		

Gain and offset parameters

Please note the information on gain and offset parameters in topic Calculating the gain and offset of analog values (Page 115).

Parameter p (number of decimals)

Applies only to the AQ value in a message text.

Functional description

The function fetches the analog signal of input Ax.

This value is multiplied by the value of the A (gain) parameter, and parameter B (offset) is then added to the product: $(Ax \cdot \text{gain}) + \text{offset} = \text{actual value Ax}$.

The actual value Ax is output at AQ.

Analog output

If you interconnect this special function with a real analog output, note that the analog output can only process values between 0 and 1000. To do this, you may need to connect an additional amplifier between the analog output of the special function and the real analog output. Using this amplifier, you standardize the output range of the special function to a value range of 0 to 1000.

Scaling an analog input value

You can influence the analog input value of a potentiometer by interconnecting an analog input with an analog amplifier and an analog flag.

- Scale the analog value at the analog amplifier for further use.
- Connect, for example, the time base for parameter T of a time function (e.g. On-/Off-delay (Page 124)) or the on and/or off limit specification of an up/down counter (Page 147) to the scaled analog value.

For more information with programming examples refer to the online help for LOGO!Soft Comfort.

Setting the Par parameter

The gain and offset parameters are used to adapt the sensors to the relevant application.

View in programming mode (example):

B3	+	
A	=02.50	← Gain
B	=-00300	← Offset
p	=0	← Decimals in the message text

View in parameter assignment mode (example):

B3
A =02.50
B =-00300
AQ =-00250

4.4.21 Latching relay

Short description

Input S sets output Q, input R resets output Q again.

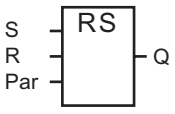
Symbol in LOGO!	Wiring	Description
	Input S	You set output Q with a signal at input S.
	Input R	You reset output Q with a signal at input R. If S and R = 1, the output is reset.
	Parameter	Retentivity: / = No retentivity R = The status is retentive.
	Output Q	Q is set with a signal at input S, and reset with a signal at input R.

Timing diagram

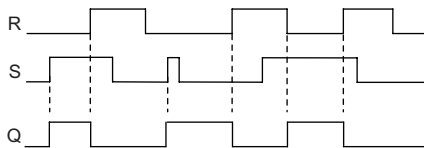

Switching response

A latching relay represents a simple binary element. The output value depends on the status at the inputs and on the previous output status. The following table shows the logic once again:

S _n	R _n	Q	Comment
0	0	x	The status is retentive
0	1	0	Reset
1	0	1	Set
1	1	0	Reset (takes priority over Set)

When retentivity is enabled, the current status of the output signal is retained after a power failure.

4.4.22 Pulse relay

Short description

A short pulse at the input sets and resets the output.

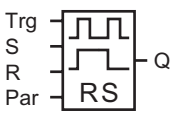
Symbol in LOGO!	Wiring	Description
	Input Trg	You set and reset output Q with a signal at input Trg (Trigger).
	Input S	You set output Q with a signal at input S.
	Input R	You reset output Q with a signal at input R.
	Parameter	Selection: RS (R input priority) or SR (S input priority) Retentivity: / = No retentivity R = The status is retentive.
	Output Q	Q is set with a signal at Trg, and reset with the next signal at Trg, if S and R = 0.

Timing diagram

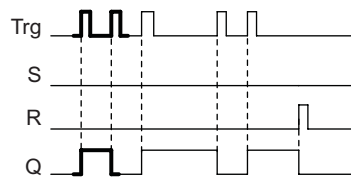

The bold printed section of the timing diagram is also shown in the symbol for the pulse relay.

Functional description

Output Q changes its status; that is, the output is set or reset with each 0 to 1 transition at input Trg and if the inputs S and R = 0.

The signal at input Trg does not influence the special function when S or R = 1.

You set the pulse relay with a signal at input S. The output is set hi.

You reset the pulse relay with a signal at input R. The output is set lo.

Status diagram

Par	Q _{n-1}	S	R	Trg	Q _n
*	0	0	0	0	0
*	0	0	0	0 ->1	1**
*	0	0	1	0	0
*	0	0	1	0 ->1	0
*	0	1	0	0	1
*	0	1	0	0 ->1	1
RS	0	1	1	0	0
RS	0	1	1	0 ->1	0
SR	0	1	1	0	1
SR	0	1	1	0 ->1	1
*	1	0	0	0	1
*	1	0	0	0 ->1	0**
*	1	0	1	0	0
*	1	0	1	0 ->1	0
*	1	1	0	0	1
*	1	1	0	0 ->1	1
RS	1	1	1	0	0
RS	1	1	1	0 ->1	0
SR	1	1	1	0	1
SR	1	1	1	0 ->1	1

*: RS or SR
 **: Triggering signal is effective, because S and R = 0.

Depending on your configuration, either input R takes priority over input S (input S is not effective when R = 1), or vice versa (input R is not effective when S = 1).

After a power failure, the pulse relay and output Q are reset if you have not enabled retentivity.

View in programming mode:

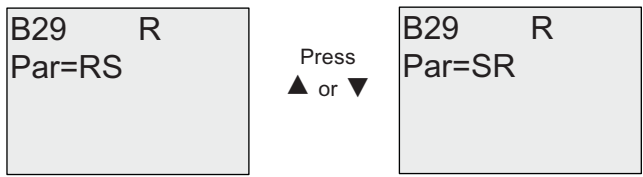

This special function is not available in parameter assignment mode.

Note

If Trg = 0 and Par = RS, the special function "Pulse relay" corresponds with the special function "Latching relay (Page 172)".

4.4.23 Message texts

Short description

With the message text function block, you can configure a message that includes text and other parameters for LOGO! to display in RUN mode.

You can configure simple message texts from the LOGO! Display. LOGO!Soft Comfort provides an extended set of features for message texts: bar graph representation of data, names for digital I/O states and more. Refer to the LOGO!Soft Comfort documentation for information on these features.

Global Message Text Settings

You configure global parameters that apply to all message texts from the Msg Config selections on the Programming menu:

- **Analog Time:** refresh rate in milliseconds that specifies how frequently analog inputs in message texts are updated
- **Tick time:** frequency at which message texts scroll on and off the display
There are two ways that a message text can tick on and off the screen: line by line, or character by character, which are described in more detail below. A line of a text message, or each character of a text message in turn will tick on and off the LOGO! Display based on the tick time. For a message that ticks line by line, the actual tick time is ten times the configured tick time. For messages that tick character by character, the actual tick time is the configured tick time.
- **CharSets:** The primary and secondary character sets from which you can configure message texts. CharSet1 and CharSet2 can be any of the supported character sets for LOGO!:

Character Set in LOGO!	Common Name	Supports Languages	Internet Reference
ISO8859-1	Latin-1	English, German, Italian, Spanish (partly), Dutch (partly)	http://en.wikipedia.org/wiki/ISO/IEC_8859-1
ISO8859-5	Cyrillic	Russian	http://en.wikipedia.org/wiki/ISO/IEC_8859-5
ISO8859-9	Latin-5	Turkish	http://en.wikipedia.org/wiki/ISO/IEC_8859-9
ISO8859-16	Latin-10	French	http://en.wikipedia.org/wiki/ISO/IEC_8859-16
GB-2312	Chinese	Chinese	http://en.wikipedia.org/wiki/GB2312
Shift-JIS	Japanese	Japanese	http://en.wikipedia.org/wiki/Shift-jis

- Current Character Set: which character set is selected for the display of message texts

Note

Message texts supported by LOGO! 0BA5 will display on the LOGO! TD only when the following conditions are met:

- CharSet1 is selected and set to ISO8859-1
 - Current Character Set "CurrCharSet" is set to CharSet1
-

Of the fifty possible message texts that you can configure, you can select any number of them to be from the first language and any number from the second language. For example, you could configure fifty message text function blocks that have a single message text for Character Set 1. Alternatively, you could configure twenty-five message text function blocks, each of which has two message texts: one for Character Set 1 and one for Character Set 2. Any combination is valid such that the total does not exceed fifty.

Within a single message text, the text must be from one character set. You can edit message texts in any of the supported character sets from LOGO!Soft Comfort. From the LOGO! Basic module, you can only edit text using characters from the ISO8859-1 character set.

The language and therefore character set of a message text is independent of the language setting for the LOGO! Display menus. They can be different.

Chinese Character Set

The LOGO! Basic module and LOGO! TD support the Chinese character set (GB-2312) for the People's Republic of China. The devices use Microsoft Windows encoding for this character set. The Windows encoding allows the devices to display the same characters as shown in the LOGO!Soft Comfort message text editor when you are using a Chinese emulator or a Chinese version of Microsoft Windows.

The Chinese character set requires a Chinese version of Windows or a Chinese emulator to properly display Chinese characters in the LOGO!Soft Comfort message text editor. You must start the Chinese emulator before you open the the message text function block in LOGO!Soft Comfort.

Programming Global Message Text Parameters

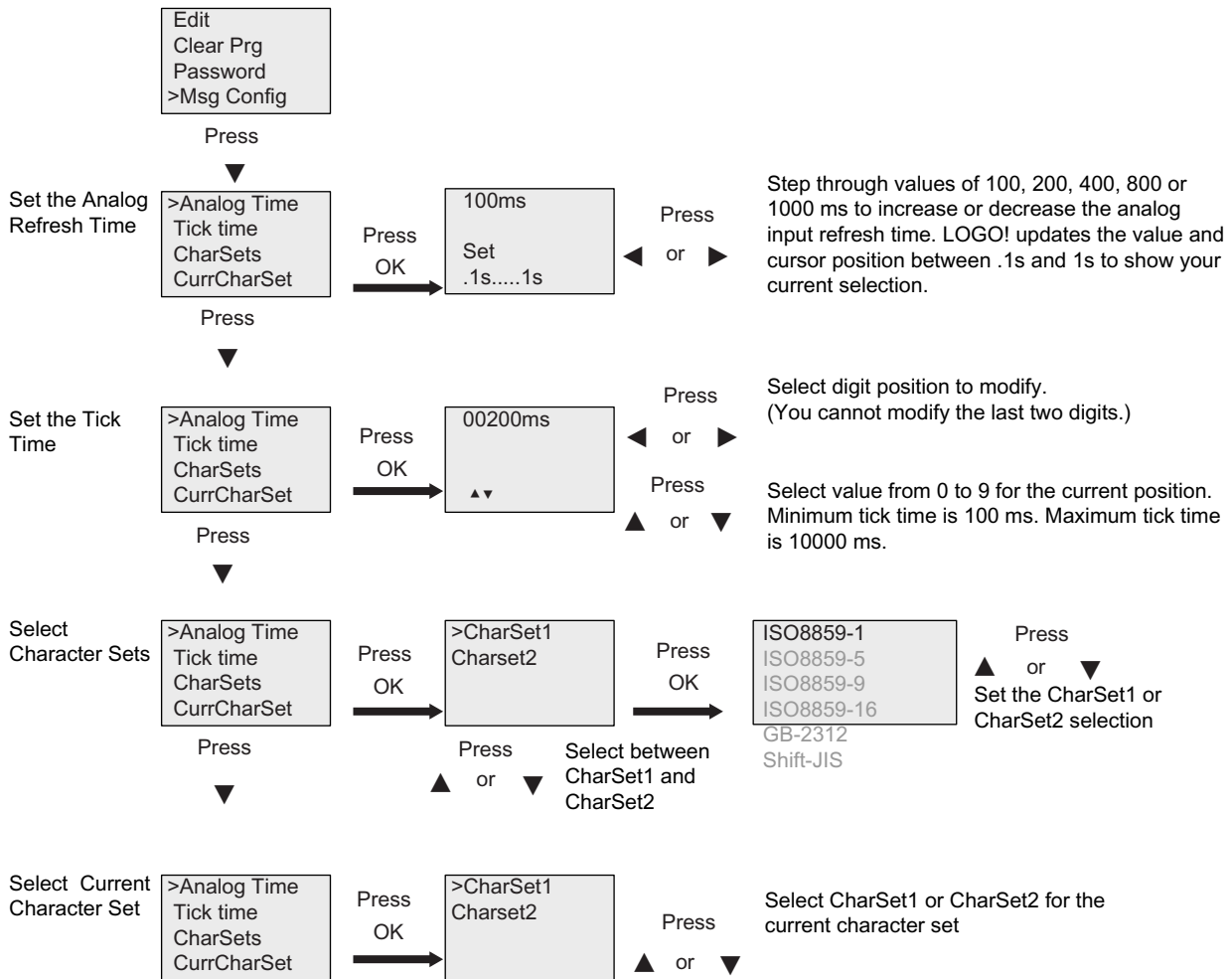

Message Text Function Block

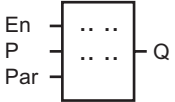
Symbol in LOGO!	Wiring	Description
	Input En	A 0 to 1 transition at input En (Enable) starts the output of the message text.
	Input P	P: Priority of the message text Range of values: 0...127 Message destination Message tick settings Ack: Acknowledgment of the message text
	Parameter	Text: Input of the message text Par: Parameter or actual value of another already-programmed function (see "Visible parameters or process variables") Time: Display of the continuously updated time-of-day Date: Display of the continuously updated date EnTime: Display of the time of the 0 to 1 transition of the signal at input En EnDate: Display of the date of the 0 to 1 transition of the signal at input En I/O status names: Display of a digital input or output status name, for example "On" or "Off" Analog Input: Display of an analog input value to be shown in message text and updated according to the analog time. Note: You can only edit the Text parameter of the message from the LOGO! Basic module. ISO8859-1 is the only available character set for editing text. You can edit all other parameters, and other languages for the Text parameter from LOGO!Soft Comfort. See the online help for configuration details.
	Output Q	Q remains set as long as the message text is set.

Restriction

A maximum of 50 message texts are available.

Functional description

When LOGO! is in RUN mode, LOGO! displays the message text that you have configured along with its parameter values upon a 0 to 1 transition of the signal at input En.

Based on your setting for the message destination, the message text displays on the LOGO! Display, the LOGO! TD, or both.

If you use flag M27 in your circuit program, then if M27=0 (low) then LOGO! displays the message text only if it is from the primary character set (Character Set 1). If M27=1 (high), then LOGO! displays the message text only if it is from the secondary character set (Character Set 2). (See the M27 flag description in topic Constants and connectors - Co (Page 102)).

If you have configured message ticking, the message will tick on and off the display according to your specifications, either a character at a time, or a line at a time.

If acknowledgment is disabled (Ack = Off), the message text is hidden when the status of the signal at input En changes from 1 to 0.

If acknowledgment is enabled (Ack = On) and the status of the signal at input En changes from 1 to 0, the message text is output until it is acknowledged with **OK**. When En = 1, you cannot acknowledge the message text.

When multiple message text functions are triggered with En=1, LOGO! displays the message text with the highest priority (0 = lowest, 127 = highest). This also means that LOGO! displays a newly activated message text only if its priority is higher than that of previously activated message texts.

After a message text is disabled or acknowledged, the function automatically shows the previously active message text that takes the highest priority.

You can press the ▲ and ▼ keys to step through multiple active message texts.

Example

This is how two message texts could be shown:

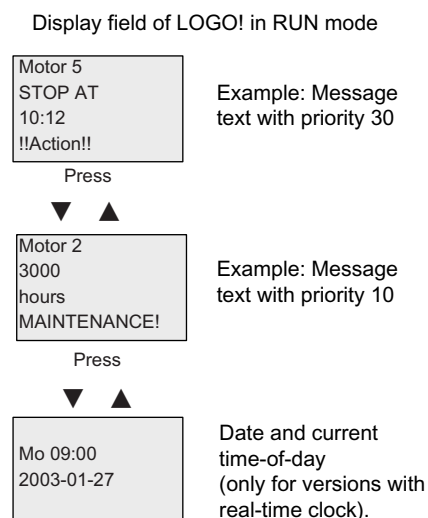

Message Ticking

You can configure message text lines to tick or not tick. Two types of message ticking exist:

- Character by character
- Line by line

Messages that tick character by character scroll off the characters of the message line one character at a time to the left with the additional characters scrolling in one at a time from the right. The time interval for the tick is specified by the TickTime message text setting.

Messages that tick line by line by line scroll one half of the message off the display to the left with the second half of the message scrolling in from the right. The time interval for the tick is ten times the TickTime parameter. The two halves of the message simply alternate on the LOGO! Display or LOGO! TD.

Example: Tick Message Character by Character

The following illustration shows a one-line, 24-character message text:

X1	X2	X3	X4	X5	X6	X7	X8	X9	X10	X11	X12	X13	X14	X15	X16	X17	X18	X19	X20	X21	X22	X23	X24

If you set this message to tick "character by character" with a tick interval of 0.1 seconds, then the initial appearance of this message line on the LOGO! Display or LOGO! TD is as shown in this illustration:



After 0.1 second, one character of the message line ticks. The message appears as follows on the LOGO! Display or LOGO! TD:

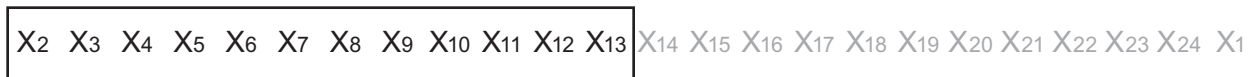

Example: Tick Message Line by Line

The following example uses the same message configuration as the previous example:

X1	X2	X3	X4	X5	X6	X7	X8	X9	X10	X11	X12	X13	X14	X15	X16	X17	X18	X19	X20	X21	X22	X23	X24

If you set this message to tick "line by line" with a tick interval of 0.1 seconds, then the initial appearance of this message on the LOGO! Display or LOGO! TD is the left half of the message as shown in this illustration:

X1 X2 X3 X4 X5 X6 X7 X8 X9 X10 X11 X12	X13 X14 X15 X16 X17 X18 X19 X20 X21 X22 X23 X24
--	---

After 1 second (10 x 0.1 second), the message ticks to show the right half of the message as shown in this illustration:

X13 X14 X15 X16 X17 X18 X19 X20 X21 X22 X23 X24	X1 X2 X3 X4 X5 X6 X7 X8 X9 X10 X11 X12
---	--

The screen display alternates between the two message halves every second.

You can configure each individual line of a message text to tick or not tick. The "character by character" or "line by line" setting applies to all lines that you configure to tick.

Input P configuration

From the input P, you configure the following characteristics of the message text:

- Priority
- Acknowledgement
- Message destination
- Tick type, and tick setting for each line

To configure the priority and the acknowledgment (programming mode):

1. Increase the priority to 1: Cursor on '0' + ▲
2. Change to 'Ack': Press ►
3. Enable 'Ack': Press ▲ or ▼

LOGO! shows:

To configure the message destination and tick type (programming mode):

1. From the Priority and Acknowledgement screen form, press ► to access the Message Destination screen form.

2. Press ► to position the cursor on the "BM" line.
3. Press ▲ or ▼ to toggle through the three choices for message destination: BM, TD, or BM & TD.
4. From the Message Destination screen form, press ► to access the Tick Type screen form.

5. If your message text has lines that tick, press ► to position the cursor on the "Ch by Ch" line and then press ▲ or ▼ to select either "Ch by Ch" or "Ln by Ln" for the TickType.

6. From the Tick Type screen, press ► to enable or disable ticking for each line of the message text. LOGO! displays the following screen form:

B33 4+/ 1 = No 2 = No

← Tick settings:
No: Line does not tick
Yes: Line does tick

7. Press ▲ or ▼ to choose between "No" and "Yes" to define whether line 1 ticks.
8. Press ► to move the cursor to the second line, and press ▲ or ▼ to choose between "No" and "Yes" for line 2. From the last line press ► to go to the screen form for lines 3 and 4. Configure line ticking for lines 3 and 4 in the same way as for lines 1 and 2.

B33 5+/ 3 = No 4 = No

← Tick settings:
No: Line does not tick
Yes: Line does tick

9. Press **OK** to confirm the complete message text configuration.

Visible parameters or process variables

The following parameters or process variables can be displayed in a message text, as either numerical values or bar-graph representations of values:

Special function	Parameter or process variable visible in a message text
Timers	
On-delay	T, T _a
Off-delay	T, T _a
On-/Off-delay	T _a , TH, TL
Retentive on-delay	T, T _a
Wiping relay (pulse output)	T, T _a
Edge triggered wiping relay	T _a , TH, TL
Asynchronous pulse generator	T _a , TH, TL
Random generator	T _H , TL
Stairway lighting switch	T _a , T, T!, T!L
Multiple function switch	T _a , T, TL, T!, T!L
Weekly timer	3*on/off/day
Yearly timer	On, Off
Counter	
Up/down counter	Cnt, On, Off
Hours counter	MI, Q, OT
Threshold trigger	f _a , On, Off, G_T

Special function	Parameter or process variable visible in a message text
Analog	
Analog threshold trigger	On, Off, A, B, Ax
Analog differential trigger	On, n, A, B, Ax, Off
Analog comparator	On, Off, A, B, Ax, Ay, nA
Analog value monitoring	n, A, B, Ax, Aen
Analog amplifier	A, B, Ax
Analog multiplexer	V1, V2, V3, V4, AQ
Analog ramp	L1, L2, MaxL, StSp, Rate, A, B, AQ
PI controller	SP, Mq, KC, TI, Min, Max, A, B, PV, AQ
Analog math	V1, V2, V3, V4, AQ
PWM (Pulse Width Modulator)	A, B, T, Ax amplified
Miscellaneous	
Latching relay	-
Pulse relay	-
Message texts	-
Softkey	On/Off
Shift register	-

For timers, a message text can also display the remaining time. "Remaining time" refers to how much time of the parameter setting remains.

Bar graphs can be either horizontal or vertical representations of the current or actual value scaled between the minimum and maximum value. For more information on configuring and displaying bar graphs in message texts, refer to the LOGO!Soft Comfort online help.

Editing message texts

Only simple message texts can be edited from the LOGO! Basic module. Text messages created in LOGO!Soft Comfort that make use of new features such as bar graphs, I/O status names, and others can not be edited from the LOGO! Basic module.

Also, you cannot edit message texts from the LOGO! Basic module that contain any of the following parameters:

- Par
- Time
- Date
- EnTime
- EnDate

You can only edit such message texts from LOGO!Soft Comfort.

Changing parameters in the active message text

When the message text is active, press **ESC** to select the editing mode.

Note

You must keep the **ESC** key pressed for at least one second.

Press ◀ and ▶ to select the relevant parameter. Press **OK** to change the parameter. Use the ▲ and ▼ keys to edit a parameter.

Confirm your changes with **OK**. You can now edit further parameters in the message text (if any exist). Press **ESC** to exit editing mode.

Key input simulation in the active message text

You can enable the four cursor keys C ▲, C ▼, C ◀ and C ▶ in an active message text by pressing **ESC** plus the relevant cursor key.

Setting the Par parameter

View in programming mode:

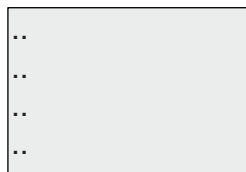

Parameter assignment
screen form for Par

Press ▶ to select a line for the message text.

Press ▲ and ▼ to select the letter to be displayed in the text. To move the cursor from one position to the other, press ◀ and ▶.

The list of available characters is the same as for the circuit program name. The character set is found in topic Circuit program input (Page 69). When you enter message text from the LOGO! Basic module, you can only enter characters from the ISO8859-1 character set. To enter text from another language, you must enter the text in LOGO!Soft Comfort.

Note that the number of characters per line of message text can be greater than the number of character positions on the LOGO! Display.

Press **OK** to confirm your changes, and press **ESC** to exit the editing mode.

4.4.24 Softkey

Short description

This special function has the effect of a mechanical pushbutton or switch.

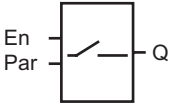
Symbol in LOGO!	Wiring	Description
	Input En	Output Q is set with a 0 to 1 transition of the signal at input En (Enable), and if 'Switch=On' was confirmed in parameter assignment mode.
	Parameter	Programming mode: Selecting the function for pushbutton action for the duration of one cycle, or for switching action. Start: On or off state, initialized at the first start of the program if retentivity is disabled. Retentivity: / = No retentivity R = The status is retentive. Parameter assignment mode (RUN mode): Switch: Switches the momentary pushbutton (switch) on or off.
	Output Q	Switches on if En=1 and Switch=On was confirmed with OK .

Factory setting

The default parameter setting is switching action.

Timing diagram

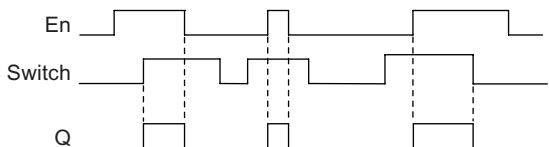

Functional description

In parameter assignment mode, the output is set with a signal at input En, if the 'Switch' parameter is set to 'On' and confirmed with **OK**. Whether the function was configured for pushbutton or switching action is of no concern here.

The output is reset to '0' in the following three cases:

- After a 1 to 0 transition at input En
- When the function was configured for momentary pushbutton action, and one cycle has expired since it was switched on
- When the position 'Off' was selected at the 'Switch' parameter and confirmed with **OK** in parameter assignment mode

If retentivity is not set, output Q is initialized after a power failure according to your configuration at the "Start" parameter.

Setting the Par parameter

View in programming mode (example):

1. Select the 'Softkey' function.
2. Select input En and confirm with **OK**. The cursor is now positioned below 'Par'.
3. Change to the input mode of 'Par': Confirm with **OK**

(the cursor is now positioned to 'On')

<p>B33 +/ <input checked="" type="checkbox"/> On= <input type="checkbox"/> <input type="checkbox"/> Start=On</p>	<p>← The status is not retentive</p> <p>← "Momentary pushbutton" function</p> <p>← Q is set in the first program cycle after program start</p>
---	--

To change 'Par' to 'Switch' action and the initialization status after the program start:

4. To select 'Momentary pushbutton' or 'Switch' action: Press **▲** or **▼**

<p>B33 +/ <input checked="" type="checkbox"/> On/Off Start=On</p>	<p>← The status is not retentive</p> <p>← "Switch"</p> <p>← Q is set in the first program cycle after program start</p>
--	---

5. To change to the start state: Press **◀** or **▶**
6. To change the start state: Press **▲** or **▼**

<p>B33 +/ On/Off Start=<input checked="" type="checkbox"/> Off</p>	<p>← The status is not retentive</p> <p>← "Switch"</p> <p>← Q is set in the init program cycle after program start</p>
---	--

7. Confirm your entries with **OK**

View in parameter assignment mode (example):

Here, you can set or reset the 'Switch' parameter (On/Off). When in RUN, LOGO! shows the following display:

<p>B33</p> <p>Switch=Off</p>	<p>The pushbutton/switch here is switched off</p>
-------------------------------------	---

Let us assume you want to set 'Switch' (On).

1. Change to the editing mode: Confirm with **OK** (the cursor is now positioned on 'Off')
2. To change from 'Off' to 'On': Press **▲** or **▼**
3. Confirm your entries with Press **OK**

<p>B33</p> <p>Switch=On</p>	<p>The pushbutton/switch here is switched on</p>
------------------------------------	--

4.4.25 Shift register

Short description

You can use the shift register function to read the value of an input and to shift its bits left or right. The output value corresponds with the configured shift register bit. The shifting direction can be changed at a special input.

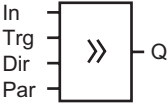
Symbol in LOGO!	Wiring	Description
	Input In	Input read at the start of the function.
	Input Trg	A positive edge (0 to 1 transition) at input Trg (Trigger) starts the special function. 1 to 0 transitions are irrelevant.
	Input Dir	The signal at input Dir determines the shifting direction for the shift register bits S1...S8: Dir = 0: Shift up (S1 >> S8) Dir = 1: Shift down (S8 >> S1)
	Parameter	Shift register bit that determines the value at output Q. Possible settings: S1 ... S8 Retentivity: / = No retentivity R = The status is retentive.
	Output Q	The output value corresponds with the configured shift register bit.

Functional description

The function reads the value at input In with a positive edge (0 to 1 transition) at input Trg (Trigger).

This value is applied to shift register bit S1 or S8, depending on the shifting direction:

- Shift up: The value at input In is set at S1; the previous value at S1 is shifted to S2; the previous value at S2 is shifted to S3 etc.
- Shift down: The value at input In is set at S8; the previous value at S8 is shifted to S7; the previous value at S7 is shifted to S6 etc.

Output Q returns the value of the configured shift register bit.

If retentivity is disabled, the shift function restarts at S1 or S8 after a power failure. When enabled, retentivity always applies to all shift register bits.

Note

The special function shift register can be used only once in the circuit program.

Timing diagram

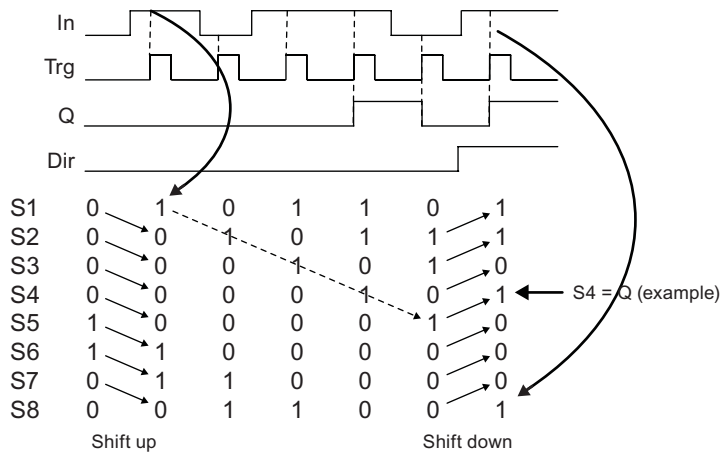

Setting the Par parameter

View in programming mode:

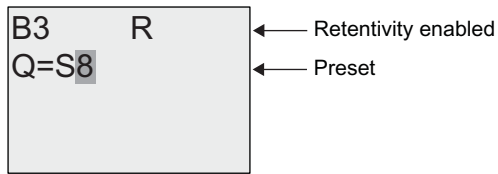

Press ▼

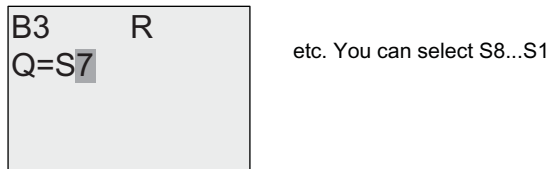

This special function is not available in parameter assignment mode.

4.4.26 Analog Multiplexer

Short description

This special function outputs one of four predefined analog values or 0 at the analog output.

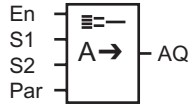
Symbol in LOGO!	Wiring	Description
	Input En	A change in status from 0 to 1 at input En (Enable) switches a parameterized analog value to the output AQ, depending on the value of S1 and S2.
	Inputs S1 and S2	S1 and S2 (selectors) for selecting the analog value to be issued. <ul style="list-style-type: none"> • S1 = 0 and S2 = 0: Value 1 is issued • S1 = 0 and S2 = 1: Value 2 is issued • S1 = 1 and S2 = 0: Value 3 is issued • S1 = 1 and S2 = 1: Value 4 is issued
	Parameter	V1...V4: Analog values that will be issued. Range of values: -32768...+32767 p: Number of decimals Range of values: 0, 1, 2, 3
	Output AQ	This special function has an analog output. This output can only be connected with the analog input of a function, an analog flag or an analog output connector (AQ1, AQ2). Range of values for AQ: -32768...+32767

Parameters V1...V4

The analog values for the parameters V1...V4 can be derived from another already-programmed function. You can use the actual values of the following functions:

- Analog comparator (Page 163) (actual value Ax – Ay)
- Analog threshold trigger (Page 157) (actual value Ax)
- Analog amplifier (Page 170) (actual value Ax)
- Analog multiplexer (actual value AQ)
- Analog ramp (Page 192) (actual value AQ)
- Analog math (Page 204) (actual value AQ)
- PI controller (Page 196) (actual value AQ)
- Up/down counter (Page 147) (actual value Cnt)

Select the required function by the block number. For information on parameter defaults, refer to the On-delay (Page 120) topic.

Parameter p (number of decimals)

Applies only to the values displayed in a message text.

Timing diagram

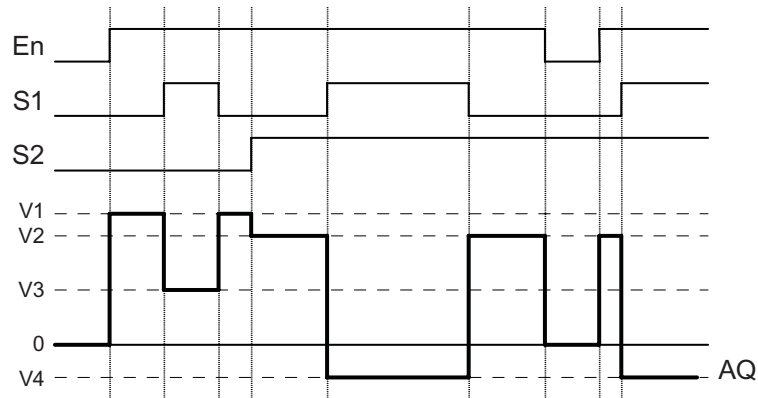

Functional description

If input En is set, then the function issues one of four possible analog values V1 to V4 at the output AQ, depending on the value of S1 and S2.

If the input En is not set, then the function issues the analog value 0 at output AQ.

Analog output

If you interconnect this special function with a real analog output, note that the analog output can only process values between 0 and 1000. To do this, you may need to connect an additional amplifier between the analog output of the special function and the real analog output. Using this amplifier, you standardize the output range of the special function to a value range of 0 to 1000.

Setting the Par parameter

View in programming mode (example):

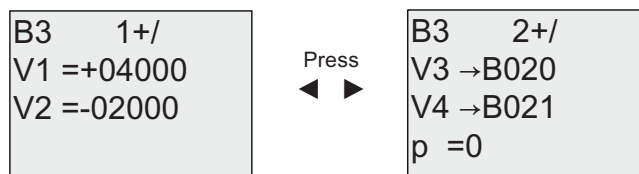

View in parameter assignment mode:

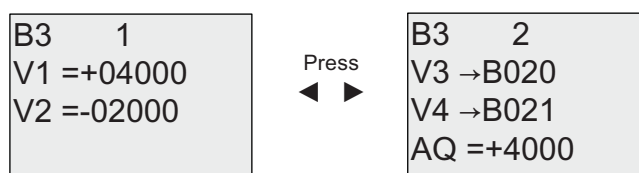

4.4.27 Analog Ramp

Short description

The Analog Ramp instruction allows the output to be changed from the current level to the selected level at a specified rate.

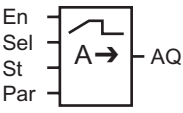
Symbol in LOGO!	Wiring	Description
	Input En	<p>A change in the status from 0 to 1 at input En (Enable) applies the start/stop level (Offset "B" + StSp) to the output for 100 ms and starts the ramp operation to the selected level.</p> <p>A change in the status from 1 to 0 immediately sets the current level to Offset "B", which makes output AQ equal to 0.</p>
	Input Sel	<p>Sel = 0: Level 1 is selected Sel = 1: Level 2 is selected</p> <p>A change in status of Sel causes the current level to start changing to the selected level at the specified rate.</p>
	Input St	<p>A change in the status from 0 to 1 at input St (Decelerated Stop) causes the current level to decrease at a constant rate until the start/stop level (Offset "B" + StSp) is reached. The start/stop level is maintained for 100ms and then the current level is set to Offset "B", which makes output AQ equal to 0.</p>
	Parameter	<p>Level 1 and Level 2: Levels to be reached Range of values for each level: -10,000 to +20,000</p> <p>MaxL: Maximum value that must not be exceeded under any circumstances. Range of values: -10,000 to +20,000</p> <p>StSp: Start/Stop offset: value that is added to Offset "B" to create the start/stop level. If the Start/Stop offset is 0, then the start/stop level is Offset "B". Range of values: 0 to +20,000</p> <p>Rate: Acceleration with which level 1, level 2 or Offset is reached. Steps/seconds are issued. Range of values: 1 to 10,000</p> <p>A: Gain Range of values: 0 to 10.00</p> <p>B: Offset Range of values: ±10,000</p> <p>p: Number of decimals Range of values: 0, 1, 2, 3</p>

Symbol in LOGO!	Wiring	Description
	Output AQ	<p>The output AQ is scaled using the formula: Range of values for AQ: 0 to +32767</p> <p>$(\text{Current Level} - \text{Offset "B"}) / \text{Gain "A"}$ Range of values: 0 to +32767</p> <p>Note: When AQ is displayed in parameter mode or message mode, it is displayed as an unscaled value (engineering units: current level).</p>

Parameters L1, L2

The analog values for the parameters L1 and L2 can be derived from another already-programmed function. You can use the actual values of the following functions:

- Analog comparator (Page 163) (actual value Ax – Ay)
- Analog threshold trigger (Page 157) (actual value Ax)
- Analog amplifier (Page 170) (actual value Ax)
- Analog multiplexer (Page 190) (actual value AQ)
- Analog ramp (actual value AQ)
- Analog math (Page 204) (actual value AQ)
- PI controller (Page 196) (actual value AQ)
- Up/down counter (Page 147) (actual value Cnt)

Select the required function by the block number. For information on parameter defaults, refer to the On-delay (Page 120) topic.

Parameter p (number of decimals)

Applies only to the AQ, L1, L2, MaxL, StSp and Rate values displayed in a message text.

Timing diagram for AQ

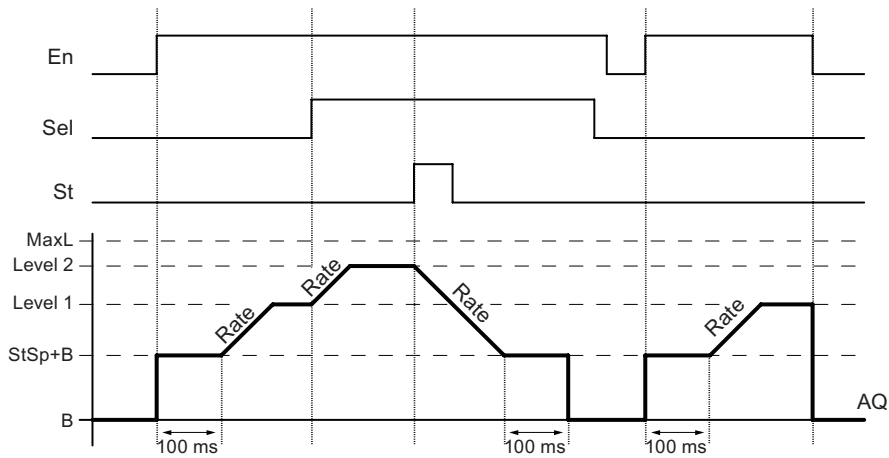

Functional description

If the input En is set, then the function sets the current level to StSp + Offset "B" for 100 ms. Then, depending on the connection of Sel, the function runs from the level StSp + Offset "B" to either level 1 or level 2 at the acceleration set in Rate.

If the input St is set, the function runs to a level of StSp + Offset "B" at the acceleration set in Rate. Then the function holds the level at StSp + Offset "B" for 100 ms. After 100 ms, the level is set to Offset "B". The scaled value (output AQ) is 0.

If the input St is set, the function can only be restarted after the inputs St and En have been reset.

If input Sel has been changed, depending on the connection of Sel, the function runs from the current target level to the new target level at the rate that is specified.

If the input En is reset, the function immediately sets the current level to Offset "B".

The current level is updated every 100 ms. Note the relationship between output AQ and the current level:

$$\text{Output AQ} = (\text{current level} - \text{Offset "B"}) / \text{Gain "A"}$$

Note

For further information on analog value processing, please refer to the online help for LOGO!Soft Comfort.

Setting the Par parameter

View in programming mode (example):

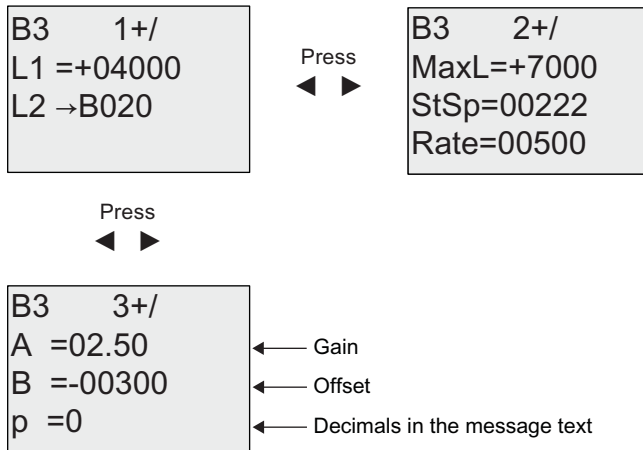

View in parameter assignment mode:

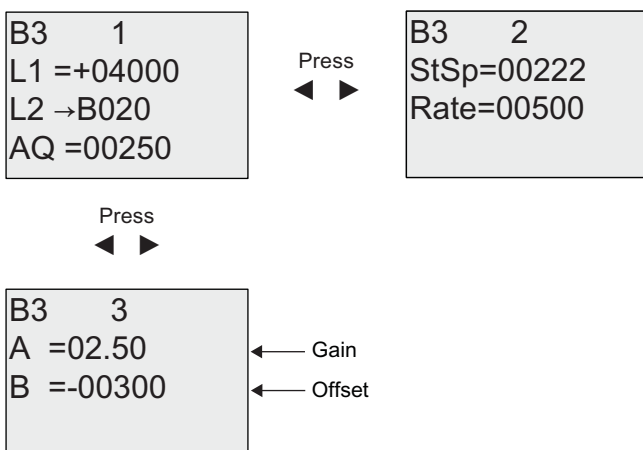

4.4.28 PI controller

Short description

Proportional-action and integral-action controllers. You can use both types of controller individually or combined.

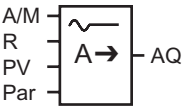
Symbol in LOGO!	Wiring	Description
	Input A/M	Set the mode of the controller: 1: automatic mode 0: manual mode
	Input R	Use the input R to reset the output AQ. As long as this input is set, the input A/M is disabled. Output AQ is set to 0.
	Input PV	Analog value: process variable, influences the output
	Parameter	SP: Set-value assignment Range of values: -10,000 to +20,000 KC: Gain Range of values: 00.00 to 99.99 TI: Integral time Range of values: 00:01 to 99:59 m Dir: Action direction of the controller Range of values: + or - Mq: Value from AQ with manual mode Range of values: 0 to 1000 Min: Minimum value for PV Range of values: -10,000 to +20,000 Max: Maximum value for PV Range of values: -10,000 to +20,000 A: Gain Range of values: ±10.00 B: Offset Range of values: ±10,000 p: Number of decimals Range of values: 0, 1, 2, 3
Output AQ	This special function has an analog output (= manipulated variable). This output can only be connected with the analog input of a function, an analog flag or an analog output connector (AQ1, AQ2). Range of values for AQ: 0...1000	

Parameters SP and Mq

The set-value SP and the value for Mq can be provided by another already-programmed function. You can use the actual values of the following functions:

- Analog comparator (Page 163) (actual value Ax – Ay)
- Analog threshold trigger (Page 157) (actual value Ax)
- Analog amplifier (Page 170) (actual value Ax)
- Analog multiplexer (Page 190) (actual value AQ)
- Analog ramp (Page 192) (actual value AQ)
- Analog math (Page 204) (actual value AQ)
- PI controller (actual value AQ)
- Up/down counter (Page 147) (actual value Cnt)

Select the required function by the block number. For information on parameter defaults, refer to the On-delay (Page 120) topic.

Parameters KC, TI

Please note:

- If parameter KC has value 0, the "P" function (proportional control) will not be executed.
- If parameter TI has value 99:59 m, the "I" function (integral-action control) will not be executed.

Parameter p (number of decimals)

Applies only to the PV, SP, Min and Max values displayed in a message text.

Timing diagram

The nature, manner and speed with which the AQ changes depend on the parameters KC and TI. Thus, the course of AQ in the diagram is merely an example. A control action is continuous; therefore the diagram portrays just an extract.

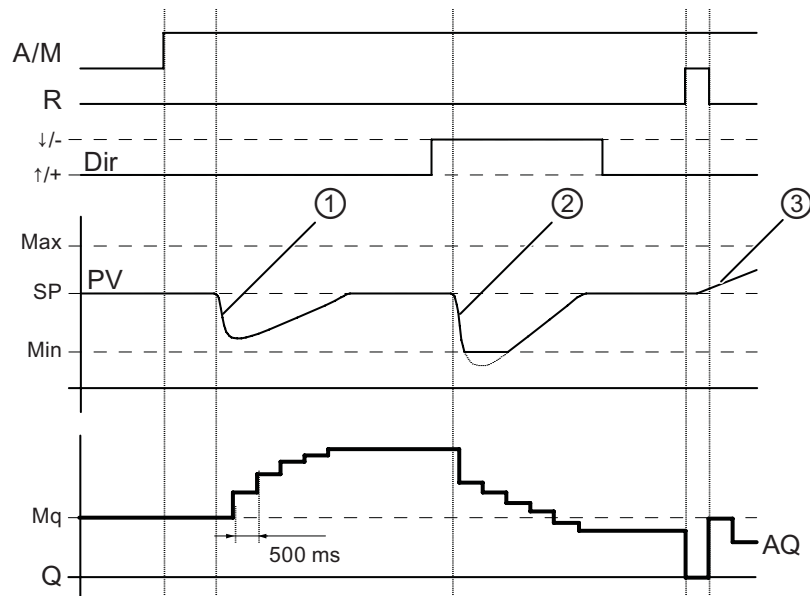

1. A disturbance causes the PV to drop, as Dir is positioned upwards, AQ increases until PV corresponds again to SP.
2. A disturbance causes the PV to drop, as Dir is positioned downwards, AQ decreases until PV corresponds again to SP.
It is not possible to change the direction (Dir) at runtime of the function. The change is shown here for illustrative purposes only.
3. As AQ is set to 0 by means of the input R, PV changes. This is based on the fact that PV increases, which on account of Dir = upwards causes AQ to drop.

Functional description

If the input A/M is set to 0, then the special function issues output AQ with the value that you set with parameter Mq.

If the input A/M is set to 1, then automatic mode commences. As an integral sum the value Mq is adopted, the controller function begins the calculations.

Note

For further information on the controller basics, please refer to the online help for LOGO!Soft Comfort.

The updated value PV is used to calculate in the formulas:

Updated value PV = (PV • gain) + offset

- If the updated value PV = SP, then the special function does not change the value of AQ.
- Dir = upwards (+) (timing diagram numbers 1. and 3.)
 - If the updated value PV > SP, then the special function reduces the value of AQ.
 - If the updated value PV < SP, then the special function increases the value of AQ.
- Dir = downwards (-) (timing diagram number 2.)
 - If the updated value PV > SP, then the special function increases the value of AQ.
 - If the updated value PV < SP, then the special function reduces the value of AQ.

With a disturbance, AQ continues to increase / decrease until the updated value PV again corresponds to SP. The speed with which AQ changes depends on the parameters KC and TI.

If the input PV exceeds the parameter Max, then the updated value PV is set to the value of Max. If the PV falls short of the parameter Min, then the updated value PV is set to the value of Min.

If the input R is set to 1, then the AQ output is reset. As long as R is set, the input A/M is disabled.

Sampling time

The sampling time is fixed at 500 ms.

Parameter sets

For more information and application examples with application-related parameter sets for KC, TI and Dir refer to the online help for LOGO!Soft Comfort.

Setting the Par parameter

View in programming mode (example):

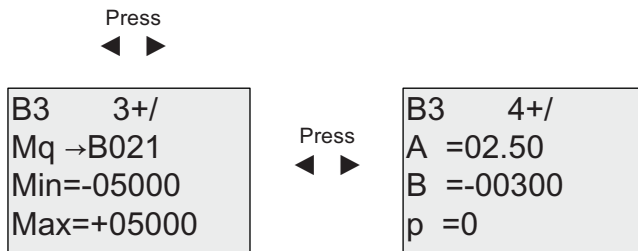

View in parameter assignment mode:

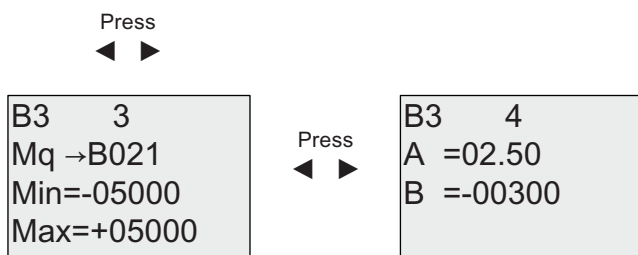

4.4.29 Pulse Width Modulator (PWM)

Short description

The Pulse Width Modulator (PWM) instruction modulates the analog input value Ax to a pulsed digital output signal. The pulse width is proportional to the analog value Ax.

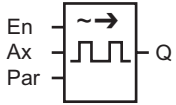
Symbol in LOGO!	Wiring	Description
	Input En	A positive edge (0 to 1 transition) at input En enables the PWM function block.
	Input Ax	Analog signal to be modulated to a pulsed digital output signal.
	Parameter	A: Gain Range of values: ± 10.00 B: Zero offset Range of values: $\pm 10,000$ T: Periodic time over which the digital output is modulated p: Number of decimals Range of values: 0, 1, 2, 3 Min: Range of values: $\pm 20,000$ Max: Range of values: $\pm 20,000$
	Output Q	Q is set or reset for the proportion of each time period according to the proportion of the standardized value Ax to the analog value range.

Parameter T

Note the defaults of the T parameters listed in topic Time response (Page 113).

The periodic time T can be provided by the actual value of another already-programmed function. You can use the actual value of the following functions:

- Analog comparator (Page 163) (actual value Ax – Ay)
- Analog threshold trigger (Page 157) (actual value Ax)
- Analog amplifier (Page 170) (actual value Ax)
- Analog multiplexer (Page 190) (actual value AQ)
- Analog ramp (Page 192) (actual value AQ)
- Analog math (Page 204) (actual value AQ)
- PI controller (Page 196) (actual value AQ)
- Up/down counter (Page 147) (actual value Cnt)

Select the required function by the block number. The timebase is configurable. For information on valid ranges and parameter defaults, refer to the On-delay (Page 120) topic.

Parameters p (number of decimals)

Parameter p applies only to the display of the Ax value in a message text

Functional description

The function reads the value of the signal at the analog input Ax. This value is multiplied by the value of parameter A (gain). Parameter B (offset) is added to the product, as follows:

$$(Ax \cdot \text{Gain}) + \text{Offset} = \text{Actual value Ax}$$

The function block calculates the proportion of the actual value Ax to the range. The block sets the digital output Q high for the same proportion of the T (periodic time) parameter, and sets Q low for the remainder of the time period.

Examples with Timing Diagrams

The following examples show how the PWM instruction modulates a digital output signal from the analog input value:

Example 1

Analog input value: 500 (range 0 ...1000)

Periodic time T: 4 seconds

The digital output of the PWM function is 2 seconds high, 2 seconds low, 2 seconds high, 2 seconds low and continues in that pattern as long as parameter "En" = high.

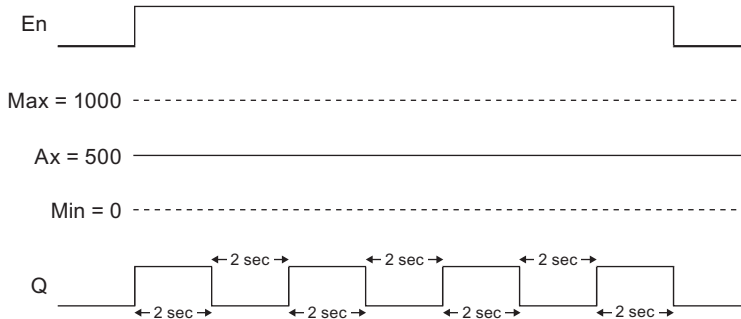

Example 2

Analog input value: 300 (range 0 ...1000)

Periodic time T: 10 seconds

The digital output of the PWM function is 3 seconds high, 7 seconds low, 3 seconds high, 7 seconds low and continues in that pattern as long as parameter "En" = high.

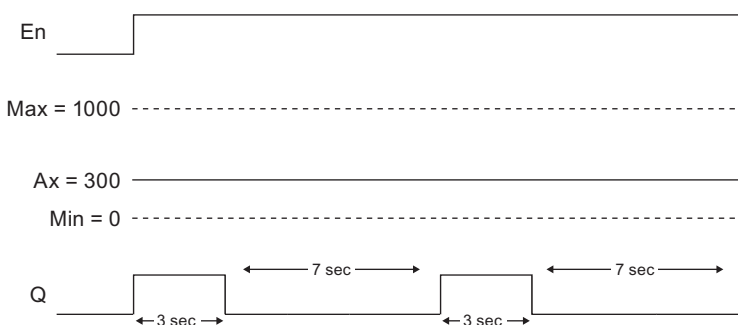

Calculation rule

$Q = 1$, for $(Ax - Min) / (Max - Min)$ of time period T, when $Min < Ax < Max$

$Q = 0$, for $PT - [(Ax - Min) / (Max - Min)]$ of periodic time T.

Note: Ax in this calculation refers to the actual value Ax as calculated using the Gain and Offset.

Setting the Par Parameter

The following illustration shows the view in programming mode that corresponds to the first example:

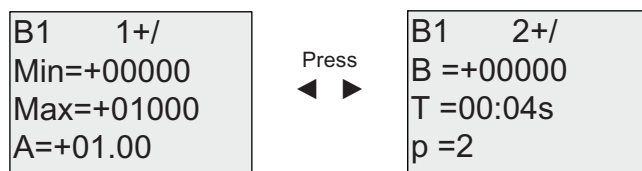

Use the ◀ and ▶ keys to navigate to the Min, Max, A, B, T and P parameters. For each digit of a value, use the ▲ and ▼ keys to scroll through value choices. Use the ▶ key to navigate to the second screen from the last line of the first screen, and the ◀ key to navigate from the top line of the second screen to the first screen. Use the OK key to accept changes.

View in parameter assignment mode:



4.4.30 Analog math

Short description

The analog math block calculates the value AQ of an equation formed from the user-defined operands and operators.

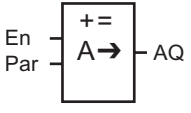
Symbol in LOGO!	Wiring	Description
	Input En	A change in the status from 0 to 1 at input En (Enable) enables the analog math function block.
	Parameter	<p>V1: First operand value V2: Second operand value V3: Third operand value V4: Fourth operand value</p> <p>Op1: First operator Op2: Second operator Op3: Third operator</p> <p>Pr1: Priority of first operation Pr2: Priority of second operation Pr3: Priority of third operation</p> <p>Qen→0: 0: Reset value of AQ to 0 when En=0 1: Retain last value of AQ when En=0 p: Number of decimals Range of values: 0, 1, 2, 3</p>
	Output AQ	The output AQ is the result of the equation formed from the operand values and operators. AQ will be set to 32767 if a divide by 0 or overflow occurs, and -32768 if a negative overflow (underflow) occurs.

Parameters V1...V4

The analog values for the parameters V1...V4 can be derived from another already-programmed function. You can use the actual values of the following functions:

- Analog comparator (Page 163) (actual value Ax – Ay)
- Analog threshold trigger (Page 157) (actual value Ax)
- Analog amplifier (Page 170) (actual value Ax)
- Analog multiplexer (Page 190) (actual value AQ)
- Analog ramp (Page 192) (actual value AQ)
- Analog math (actual value AQ)
- PI controller (Page 196) (actual value AQ)
- Up/down counter (Page 147) (actual value Cnt)

Select the required function by the block number. For information on parameter defaults, refer to the On-delay (Page 120) topic.

Note

If the analog value for parameter V1, V2, V3 or V4 is derived from another already-programmed function whose actual value exceeds the value range for V1 ... V4, LOGO! will display the limit value: -32768 if the value is less than the lower range or 32767 if the value is greater than the upper range).

Parameters p (number of decimals)

Parameter p applies only to the display of Value1, Value2, Value3, Value4 and AQ in a message text.

Functional Description

The analog math function combines the four operands and three operators to form an equation. The operator can be any one of the four standard operators: +, -, *, or /. For each operator, you must set a unique priority of High (H), Medium (M), or Low (L). The high operation will be performed first, followed by the medium operation, and then by the low operation. You must have exactly one operation of each priority. The operand values can reference another previously-defined function to provide the value. The analog math function rounds the result to the nearest integer value.

The number of operand values is fixed at four and the number of operators is fixed at 3. If you need to use fewer operands, use constructions such as + 0 or * 1 to fill the remaining parameters.

You can also configure the behavior of the function when the Enable parameter En=0. The function block can either retain its last value, or be set to 0. If the parameter Qen → 0 = 0, then the function sets AQ to 0 when En=0. If the parameter Qen → 0 = 1, then the function leaves AQ at its last value when En=0.

Possible errors: Zero division and overflow

If the analog math function block execution results in zero division or overflow, it sets internal bits that indicate the type of error that occurred. You can program an analog math error detection function block in your circuit program to detect these errors, and to control the program behavior as needed. You program one analog math error detection function block to reference one specific analog math function block.

Examples

The following tables show some simple example analog math block parameters, and the resulting equations and output values:

V1	Op1 (Pr1)	V2	Op2 (Pr2)	V3	Op3 (Pr3)	V4
12	+ (M)	6	/ (H)	3	- (L)	1

Equation: $(12 + (6 / 3)) - 1$

Result: 13

V1	Op1 (Pr1)	V2	Op2 (Pr2)	V3	Op3 (Pr3)	V4
2	+ (L)	3	* (M)	1	+ (H)	4

Equation: $2 + (3 * (1 + 4))$

Result: 17

V1	Op1 (Pr1)	V2	Op2 (Pr2)	V3	Op3 (Pr3)	V4
100	- (H)	25	/ (L)	2	+ (M)	1

Equation: $(100 - 25) / (2 + 1)$

Result: 25

Setting the Par parameter

The following illustration shows the view in programming mode that corresponds to the first example $(12 + (6 / 3)) - 1$:

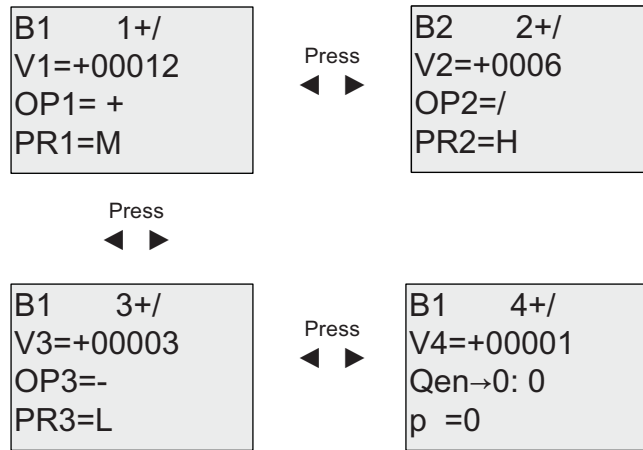

Use the ◀ and ▶ keys to navigate between the operand value, operator, and operation priority. To change a value, use the ▲ and ▼ keys to scroll through value choices for each value. Use the ◀ key to navigate from one screen to the previous screen when the cursor is on the V1..V4 line, and the ▶ key to navigate to the next screen from the PR1..PR3 line. Use the OK key to accept changes.

4.4.31 Analog math error detection

Short description

The analog math error detection block sets an output if an error has occurred in the referenced analog math function block (Page 204).

Symbol in LOGO!	Wiring	Description
	Input En	A change in the status from 0 to 1 at input En (Enable) enables the analog math error detection block.
	Input R	A signal at input R resets the output.
	Parameter	MathBN: block number of an analog math instruction Err: ZD: Divide by 0 error OF: Overflow error ZD/OF: (Divide by 0 error) OR (Overflow error) AutoRst: Reset the output before the next execution of the analog math error function block. Y = yes; N = no
	Output Q	Q is set high if the error to detect occurred in the last execution referenced analog math function block

Parameter MathBN

The value for the MathBN parameter references be the block number of an already-programmed analog math function block.

Functional description

The analog math error detection block sets the output when the referenced analog math function block has an error. You can program the function to set the output on a zero division error, an overflow error, or when either type of error occurs.

If AutoRst is set, the output is reset prior to the next execution of the function block. If AutoRst is not set, then whenever the output is set it remains set until the analog math error detection block is reset with the R parameter. This way, even if the error subsequently clears, the circuit program still has knowledge that an error did occur at some point.

In any scan cycle, if the referenced analog math function block executes before the analog math error detection function block, the error is detected in the same scan cycle. if the referenced analog math function block executes after the analog math error detection function block, the error is detected in the next scan cycle

Analog math error detection logic table

In the table below, Err represents the parameter of the analog math error detection instruction that selects which type of error to detect. ZD represents the zero division bit set by the analog math instruction at the end of its execution: 1 if the error occurred, 0 if not. OF represents the overflow bit set by the analog math instruction: 1 if the error occurred, 0 if not. The ZD/OF Err parameter represents the logical OR of the zero division bit and overflow bit of the referenced analog math instruction. Q represents the output of the analog math error detection function. An "x" indicates that the bit can be either 0 or 1 with no influence on the output.

Err	ZD	OF	Q
ZD	1	x	1
ZD	0	x	0
OF	x	1	1
OF	x	0	0
ZD/OF	1	0	1
ZD/OF	0	1	1
ZD/OF	1	1	1
ZD/OF	0	0	0

If the MathBN parameter is null, then the output Q is always 0.

Setting the Par parameter

The parameters MathBN, AutoRst, and Err can be set in programming mode or parameter assignment mode.

View in programming mode (example):

B3 +/ MathBN=B001 AutoRst=N Err=ZD/OF	← Block number of an already-programmed analog math instruction
	← Auto Reset (Y or N)
	← ZD, OF, or ZD/OF

Use the ◀ and ▶ keys to navigate between the MathBN, AutoRst, and Err parameters. To change a value, use the ▲ and ▼ keys to scroll through value choices for each value. Use the OK key to accept changes.

View in parameter assignment mode (example):

B3 MathBN=B001 AutoRst=N Err=ZD/OF	← Block number of an analog math instruction
	← Auto Reset (Y or N)
	← ZD, OF, or ZD/OF

Configuring LOGO!

Parameter assignment refers to the configuration of the block parameters. You can set delay times for time functions, the switching times of timers, counter threshold values, the monitoring interval of an hours counter, the on and off thresholds of the trigger, and more.

You can configure the parameters

- In programming mode
- In parameter assignment mode

In programming mode, the author of the circuit program also sets the parameters

Parameter assignment mode allows the editing of parameters without having to modify the circuit program. This feature is available so that you can edit parameters without having to change to programming mode. The advantage: The circuit program remains protected, but can be adapted by the user to meet specific requirements.

Note

In parameter assignment mode, LOGO! continues execution of the circuit program.

5.1 Selecting parameter assignment mode

Press ESC to change from RUN to parameter assignment mode:

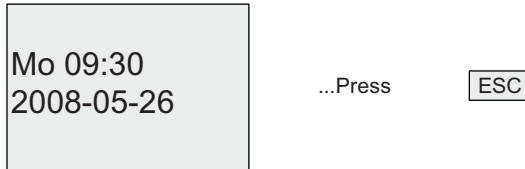

Note

The following applies to earlier device versions up to 0BA2: you open parameter assignment mode by pressing **ESC+OK**.

LOGO! changes to parameter assignment mode and opens the parameter assignment menu:

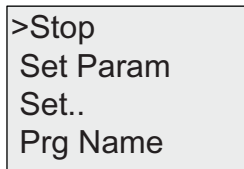

Description of the four menu items of the parameter assignment menu

- **Stop**

You select this command to stop your circuit program and thus change to the main menu of programming mode. To do so:

1. To move the '>' cursor to '**Stop**': Press ▲ or ▼
2. To confirm 'Stop': Press **OK**

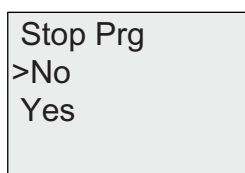

3. To move the '>' cursor to '**Yes**': Press ▲ or ▼
4. To confirm 'Yes': Press **OK**

LOGO! shows the main menu of the programming mode:

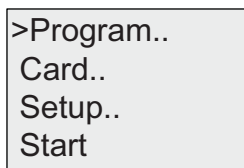

- **Set Param**

For information on the various parameters, refer to the topics "Parameters (Page 213)", "Selecting the parameters (Page 214)", and "Modifying parameters (Page 215)".

- **Set..**

For information on the various settings, refer to the topic "Setting the default values for LOGO! (Page 217)".

- **Prg Name**

This menu command only allows you to **read** the name of your circuit program. It is not possible to modify this name in parameter assignment mode (Page 73).

5.1.1 Parameters

Note

In the following discourse on parameters, we presume that the respective default parameter mode ("+") has been maintained. This is a prerequisite for viewing and editing parameters in the parameter assignment mode! See the "Parameter protection (Page 114)" topic and the "Synchronization (Page 96)" topic.

Parameters are, for example:

- The delay times of a timer relay.
- The switching times (cams) of a timer switch.
- Counter thresholds
- The monitoring time for hour counters
- The trigger thresholds.

Each one of the parameters is identified by its block number (Bx) and the shortname of the parameter. Examples:

- T: ...is a configurable time.
- MI: ...is a configurable time interval.

Note

LOGO!Soft Comfort also allows you to assign names to blocks (for more information, refer to the chapter entitled "LOGO! Software (Page 233)".

5.1.2 Selecting the parameters

To select a parameter:

1. On the parameter assignment menu, select 'Set Param': Press ▼ or ▲

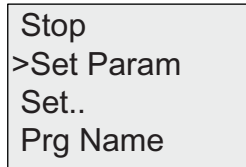

2. Confirm with **OK**.
LOGO! shows the first parameter. If no parameter can be set, you can press ESC to return to the parameter assignment menu.

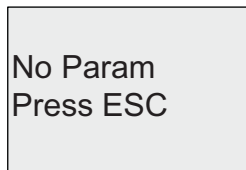
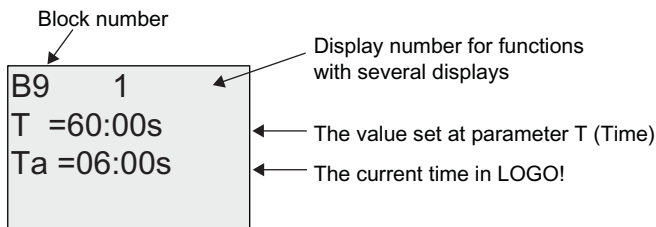

No parameters for editing:
Press ESC to return to the parameter assignment menu

3. Now, select the desired parameter: Press ▲ or ▼
4. Select the parameter you want to edit, and press **OK**.

5.1.3 Modifying parameters

You first select the parameter you want to edit (Page 214).

You change the value of the parameter in the same way as you did in programming mode:

1. Move the cursor to the point at which you want to make the change:
Press ◀ or ▶
2. To change this value: Press ▲ or ▼
3. To apply the value: **OK**

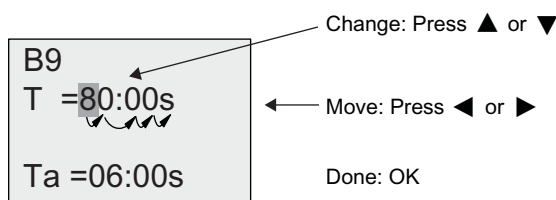

Note

When changing the time parameter when the system is in RUN, you can also change the timebase (s=seconds, m=minutes, h=hours). This does not apply if the time parameter represents the result of another function (for an example, see the "On-delay (Page 120)" topic). In this case you can neither change the value nor the timebase. The current time is reset to zero when you change the timebase.

Current value of a time T

View of a time T in parameter assignment mode:

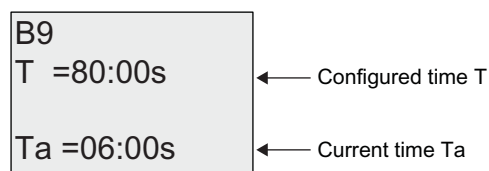

You can change the configured time T.

Current timer value

View of a timer cam in parameter assignment mode:

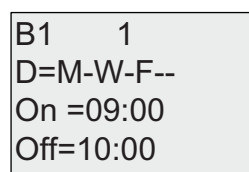

You can change the on/off times and the day.

Current value of a counter

View of a counter parameter in parameter assignment mode:

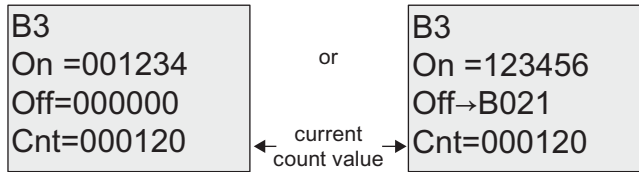

You can change the on/off threshold. This does not apply if the on or off threshold represents the result of another function (in the "Up/down counter (Page 147)" topic, this is B021).

Current value of an hour counter

View of an hour counter parameter in parameter assignment mode:

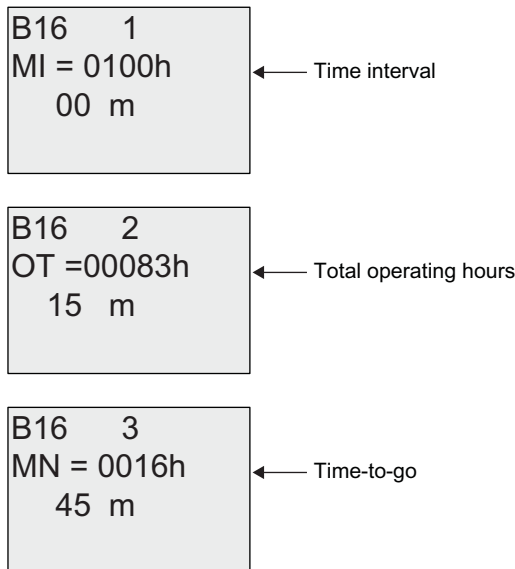

You can edit the configured time interval MI.

Current value of a threshold trigger

View of the parameter of a threshold trigger in parameter assignment mode:

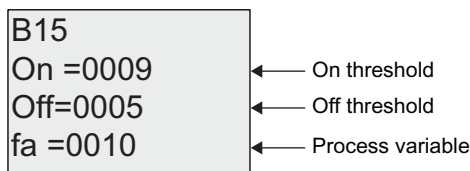

You can change the on/off threshold.

5.2 Setting the default values for LOGO!

You can set the following default values for a LOGO! Basic module:

Clock settings

You can set the default values for time-of-day and date (Page 218) , summertime/wintertime conversion (Page 92) and synchronization (Page 96):

- in parameter assignment mode by means of the set menu ("Clock" menu item)
- in programming mode by means of the setup menu ("Clock" menu item).

Contrast and backlight settings

You can set the default values for the display contrast and backlight (Page 219):

- in parameter assignment mode by means of the set menu ("LCD" menu item)
- in programming mode by means of the setup menu ("LCD" menu item).

Menu Language

You can set the language (Page 220) in which the LOGO! menus will be displayed:

- in parameter assignment mode by means of the set menu ("Menu Lang" menu item)
- in programming mode by means of the setup menu ("Menu Lang" menu item)

Number of Basic Module Analog Inputs

The LOGO! Basic Modules LOGO! 24/o, and LOGO! 12/24RC/o support four analog inputs. Formerly they supported two. You can choose whether to use two or four analog inputs (Page 221) on these modules:

- in parameter assignment mode by means of the set menu ("BM AI NUM" menu item)
- in programming mode by means of the setup menu ("BM AI NUM" menu item)

Start screen settings

You can select the default setting for the start screen (Page 222) that displays on LOGO! and the LOGO! TD when LOGO! transitions to RUN mode:

- in parameter assignment mode by means of the set menu ("StartScreen" menu item)

Message Text settings

You can select settings that apply to all message text function blocks (Page 175) from the Programming menu.

5.2.1 Setting the time of day and date (LOGO! ... C)

You can set the time of day and the date

- in parameter assignment mode by means of the set menu ("Clock" menu item)
- in programming mode by means of the setup menu ("Clock" menu item)

To set the TOD and the date in parameter assignment mode:

1. Select parameter assignment mode (Page 212).
2. On the parameter assignment menu, select '**Set..**': Press ▼ or ▲

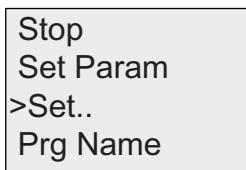

3. Confirm '**Set..**': Press **OK**
4. Move the '>' cursor to '**Clock**': Press ▲ or ▼
5. Confirm '**Clock**': Press **OK**
6. Move the '>' cursor to '**Set Clock**': Press ▲ or ▼
7. Apply '**Set Clock**': Press **OK**

Note

The 'Set Clock' command is only executed if your LOGO! is equipped with a real-time clock (LOGO!..C). You set the real-time clock of LOGO! by means of the 'Set Clock' command.

LOGO! shows the following display.

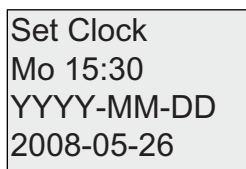

The cursor is positioned on the weekday.

8. Select the day of the week: Press ▲ or ▼
9. Move the cursor to the next position: Press ◀ or ▶
10. To change the value: Press ▲ or ▼
11. To set the correct TOD, repeat steps 9. and 10.
12. To set the correct date, repeat steps 9. and 10.
13. To confirm your entries: Press **OK**

To set the TOD and the date in programming mode:

If you want to set the TOD and the date in programming mode, select '**Setup**' in the main menu, then menus '**Clock**' and '**Set Clock**'. You can now set the weekday and the time as described earlier (as of step 8.).

5.2.2 Setting the display contrast and backlight choice

You can set the default value for the display contrast

- in parameter assignment mode by means of the set menu "LCD" menu item)
- in programming mode by means of the setup menu ("LCD" menu item).

To set the display contrast in parameter assignment mode:

1. Select parameter assignment mode (Page 212).
2. On the parameter assignment menu, select '**Set**': Press ▼ or ▲
3. Confirm 'Set..': Press **OK**
4. On the Set menu, select 'LCD': Press ▼ or ▲
5. Confirm 'LCD..': Press **OK**
6. By default, the cursor points to **Contrast**.
If not, move the '>' cursor to '**Contrast**': Press ▲ or ▼
7. Confirm 'Contrast': Press **OK**

LOGO! shows the following display:



8. To change the display contrast: Press ◀ or ▶
9. To confirm your entry: Press **OK**

To set the display contrast in programming mode:

If you want to set the display contrast in programming mode, select '**Setup**' in the main menu, then menu '**Contrast**'. You can now set the display contrast as described earlier (as of step 8.).

To set the backLight choice in parameter assignment mode:

1. Select parameter assignment mode.
2. On the parameter assignment menu, select '**Set**': Press ▼ or ▲
3. Confirm 'Set.': Press **OK**
4. On the Set menu, select 'LCD': Press ▼ or ▲
5. Confirm 'LCD.': Press **OK**
6. Move the '>' cursor to '**BackLight**': Press ▲ or ▼
7. Confirm '**BackLight**': Press **OK**
8. Move the '>' cursor to '**Default**' or '**AlwaysOn**': Press ▲ or ▼

The default is that the back light is not on. To set the back light to always be on, select the '**AlwaysOn**' choice.

To set the back light choice in programming mode:

If you want to set the backlight choice in programming mode, select '**Setup**' in the main menu, then menu 'LCD'. You can now set the back light choice as described earlier (as of step 6.).

Note: The backlight lifetime of the LOGO! TD is 20,000 hours.

5.2.3 Setting the menu language

The language of the LOGO! menus can be one of ten predefined languages:

CN (Chinese)	DE (German)	EN (English)	ES (Spanish)	FR (French)
IT (Italian)	NL (Dutch)	RU (Russian)	TR (Turkish)	JP (Japanese)

To set the menu language in parameter assignment mode:

1. Select parameter assignment mode (Page 212).
2. On the parameter assignment menu, select '**Set**': Press ▼ or ▲
3. Confirm 'Set.': Press **OK**
4. On the Set menu, select '**Menu Lang**': Press ▼ or ▲
5. Confirm 'Menu Lang': Press **OK**
6. Move the '>' cursor to the language of your choice: Press ▲ or ▼
7. Confirm language selection. Press **OK**

To set the menu language in programming mode:

If you want to set the menu language in programming mode, select '**Setup**' in the main menu, then menu '**Menu Lang**'. You can now set the menu language as described earlier (as of step 6.).

To reset LOGO! to its default language setting:

If you want to restore LOGO! to its default language setting (English), do the following:

1. Switch off LOGO! and then switch it on again.
2. When an hour glass icon displays, press ◀, ▶ and **OK** together until the English menu entries appear.

5.2.4 Setting the number of AIs in the Basic Module

LOGO! 12/24RC/RCo and LOGO! 24/24o support up to four onboard inputs that can be used as either digital or analog inputs (0 ...10V). Inputs I7 (AI1) and I8 (AI2) are available as analog inputs by default, whether you use them or not. Inputs I1 (AI3) and I2 (AI4) are optional analog inputs. LOGO! provides a menu where you can choose to use two analog inputs (the default, AI1 and AI2), or four. Regardless of the settings, inputs I1 and I2 can be used as digital inputs. To use them as analog inputs AI3 and AI4, you must set the 'BM AI NUM' to four. Note that the number of configured analog inputs on the LOGO! Basic Module affects the subsequent numbering of analog inputs on attached expansion modules (See the "Maximum setup (Page 26)" topic).

To set the number of AIs in parameter assignment mode:

1. Select parameter assignment mode (Page 212).
2. On the parameter assignment menu, select '**Set**': Press ▼ or ▲
3. Confirm 'Set.': Press **OK**
4. On the Set menu, select '**BM AI NUM**': Press ▼ or ▲
5. Confirm 'BM AI NUM': Press **OK**
6. Move to '2AI' or '4AI': Press ▲ or ▼
7. Confirm selection. Press **OK**

To set the number of AIs in programming mode:

If you want to set the number of AIs in programming mode, select '**Setup**' in the main menu, then menu '**BM AI NUM**'. You can now set the number of AIs as described earlier (as of step 6.).

Note

If you change the number of analog inputs, LOGO! restarts automatically.

5.2.5 Setting the start screen

You can select the default setting for the start screen that LOGO! and the LOGO! TD will display in RUN mode. You make this selection from the parameter assignment mode by means of the set menu ("StartScreen" menu item).

To select the start screen:

1. Select parameter assignment mode (Page 212).
2. On the parameter assignment menu, select '**Set..**': Press ▼ or ▲
3. Confirm '**Set..**': Press **OK**
4. Move to '**StartScreen**': Press ▲ or ▼

Confirm '**StartScreen**': Press **OK**LOGO! shows the following display:

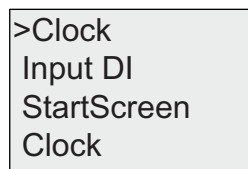

The current setting of the start screen is shown in the bottom row. The default setting is 'Clock'.

You can choose between the display of the current time-of-day and date, or the values of the digital inputs:

5. Select the desired default setting: Press ▲ or ▼
6. To confirm your entry: Press **OK**

LOGO! displays your selection.

Power the LOGO! Basic module off then on to make your changes take effect. When LOGO! is in RUN mode, both LOGO! and the LOGO! TD will display the start screen that you selected.

LOGO! memory and battery cards

LOGO! provides the following cards for program storage and real-time clock backup:

- LOGO! Memory Card
- LOGO! Battery Card
- LOGO! Memory/Battery Card

Each of the three cards is color-coded to make them easily distinguishable from one another. They also vary in size. The LOGO! Memory Card (purple) provides storage for the circuit program. The LOGO! Battery Card (green) provides battery backup of the real-time clock for up to two years. The LOGO! Memory/Battery card (brown) provides both circuit program storage and battery backup of the real-time clock.

WARNING

Risk of death, personal injury or property damage can occur if you use the battery card or combined memory/battery card in a hazardous location.

Use the battery card or combined memory/battery card only in non-hazardous locations.

The LOGO! 0BA6 Memory Card and the LOGO! 0BA6 Memory/Battery Card provide 32 Kbytes memory space: four times the memory space of the LOGO! 0BA5 Memory Card.

LOGO! allows you to store only one circuit program in its memory. If you want to modify the circuit program or create an additional one without deleting the first, you must archive it somewhere.

You can copy the LOGO! circuit program to a LOGO! Memory Card or LOGO! Memory/Battery card. You can then insert this card in another LOGO! in order to copy the circuit program. This enables you to manage your programs in the following ways:

- Archive circuit programs
- Reproduce circuit programs
- Send circuit programs by mail
- Write and test your circuit program at the office, and then transfer it to a LOGO! in the switching cabinet

LOGO! is supplied with a hood. The LOGO! Memory Card, LOGO! Battery Card and LOGO! Memory/Battery Card are supplied separately.

Note

You do **not** need a memory card or combined memory/battery card to backup the circuit program in your LOGO!

The LOGO! circuit program is automatically stored in nonvolatile memory when you exit the programming mode.

The memory card or combined memory/battery card can backup all data in the LOGO! circuit program memory. The order numbers are found in the Appendix section entitled "Order numbers (Page 277)".

Compatability (Old memory cards in newer LOGO! modules)

... to earlier versions (0BA4 and 0BA5 devices):

Data written to the memory card in an 0BA5 version can be read in all 0BA6 versions. 0BA4 memory cards cannot be read by 0BA6 versions.

... to earlier versions (0BA0 to 0BA3 devices):

A memory card that contains data written in earlier versions (0BA0...0BA3 devices) cannot be used in LOGO! devices of the 0BA4 and later generations. When the LOGO! system detects such an 'old' memory card, the message "Unknown Card / Press ESC" is output to the display.

Vice versa, an 0BA4 or later memory card cannot be used in LOGO! devices of the 0BA0...0BA3 family.

Compatibility (New memory, battery, or combined memory/battery cards in older LOGO! modules)

The LOGO! 0BA6 memory card can be used in 0BA4 or 0BA5 devices to store a circuit program but cannot be used in 0BA0..0BA3 devices.

A LOGO! 0BA6 Memory Card or LOGO! 0BA6 Memory/Battery Card that already has a LOGO! 0BA6 circuit program stored on it cannot be used in any device other than a LOGO! 0BA6 device.

A LOGO! 0BA6 Battery Card or LOGO! 0BA6 Memory/Battery Card can only be used in 0BA6 devices.

Upward compatibility of circuit programs

Circuit programs written for the previous versions 0BA0...0BA5 can be transferred to 0BA6 units from LOGO!Soft Comfort.

6.1 Security function (CopyProtect)

The security function provides copy protection for circuit programs on memory cards or combined memory/battery cards.

Unprotected memory cards

You can edit circuit programs without restrictions and exchange data between the memory card or combined memory/battery card and the device.

Protected memory cards

A circuit program is **protected** when it is transferred from a protected program memory card or combined memory/battery card to LOGO!.

To execute this circuit program in LOGO!, the protected card must remain inserted during RUN; that is, the circuit program stored on the card cannot be copied to other LOGO! devices.

Over and above that, a protected circuit program is write-protected.

A circuit program **with password** protection is no longer protected after the correct password has been entered; that is, you can then edit the program and remove the memory card or combined memory/battery card.

Note

When you create the circuit program for a memory card or combined memory/battery card, you need to assign a password (Page 74) to be able to edit it at a later time.

Correlation between the password and the protective function

Password	Protection	Editing	Copying	Deleting
-	-	Yes	Yes	Yes
Yes	-	Yes, with password	Yes	Yes, with password
-	Yes	No	No	Yes
Yes	Yes	Yes, with password	Yes, with password	Yes, with password

Assigning a security function

To assign a circuit program and copy protection function to the memory card or combined memory/battery card, open the programming mode and select "Card".

1. Switch LOGO! to programming mode (ESC / >Stop).
2. Select the '**Card**' command: Press ▲ or ▼
3. To apply 'Card': Press **OK**
4. Move the '>' cursor to '**CopyProtect**': Press ▲ or ▼
5. To apply 'CopyProtect': Press **OK**

LOGO! shows the following display:

```
>No
Yes
CopyProtect:
No
```

The current protection setting is shown in the bottom line. This function is disabled by default ("No": disabled).

Enabling the security function

To set the security function:

1. Move the '>' cursor to '**Yes**': Press ▲ or ▼
2. Confirm 'Yes': Press **OK**

LOGO! shows the following display:

```
>No
Yes
CopyProtect:
Yes
```

Note

This only generates a circuit program and copy protection for the memory card or combined memory/battery card; the circuit program itself must be copied (Page 229) separately from LOGO! to the memory card or combined memory/battery card. (This copy can be done at power-on.)

You can always change the "No" status (security function disabled) to "Yes" (security function enabled).

A status change from "Yes" (security function enabled) to "No" (security function disabled) is only possible if the memory card or combined memory/battery card does not contain a circuit program.

6.2 Inserting and removing memory and battery cards

When you remove a memory card or combined memory/battery card that contains a circuit program with copy protection attributes, note the following: The circuit program stored on the card can only be executed if the card remains inserted during system runtime.

After you have removed the memory card or combined memory/battery card, LOGO! outputs the message 'No Program'. A removal of the card during RUN will lead to impermissible operating states.

Always heed the following warning:

 WARNING
Do not touch the open slot of the memory card with your fingers or with a metallic or conductive object.
The memory card socket might be under voltage if the polarity is accidentally reversed at L1 and N.
The memory card, battery card or combined memory/battery card must only be removed by qualified personnel.

Removing the memory card, battery card or combined memory/battery card

To remove the memory card, carefully insert a screwdriver with a 3-mm blade into the groove on the upper end of the card, and lever the module partially out of the slot. You can now remove the memory card.

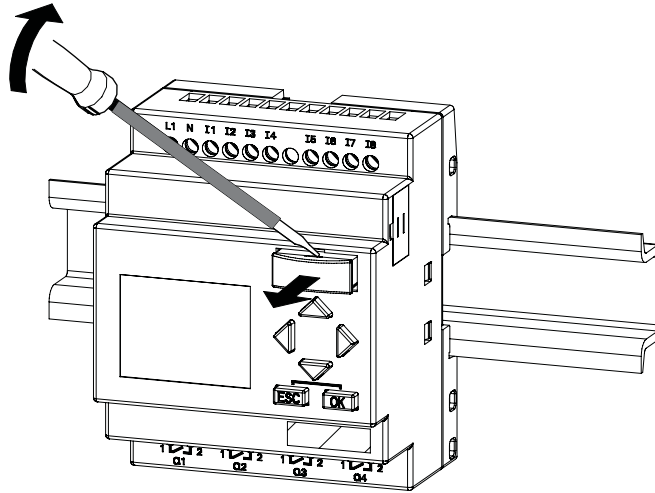

To remove a battery card, or combined memory/battery card, slide a screwdriver with a 3-mm blade into the slot on the upper surface of the card until it engages in the back, then with the screwdriver engaged, pull the card out with your hand.

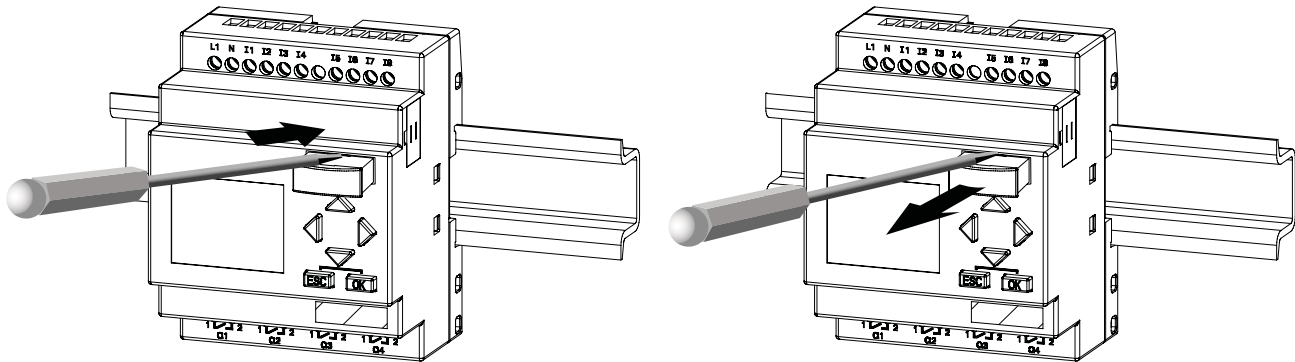

Inserting a memory card, battery card or combined memory/battery card

The entry of the memory card, battery card and the combined memory/battery card slot is chamfered on its bottom right. The edge of the cards is chamfered accordingly. This encoding prevents you from inserting cards the wrong way. Insert the memory card, battery card or combined memory/battery card into the slot and push it in until it engages.

6.3 Copying data from LOGO! to the memory card

To copy the circuit program to the memory card or combined memory/battery card:

1. Insert the memory card or combined memory/battery card into the slot.
2. Switch LOGO! to programming mode (ESC / >Stop).



3. The main menu opens. To select the 'Card' command: Press ▲ or ▼
4. Press OK. The transfer menu opens.

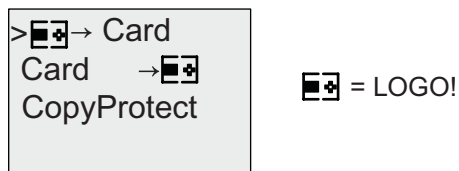

5. Move the '>' cursor to 'LOGO → Card' (if required): Press ▲ or ▼
6. Press OK.

LOGO! now copies the circuit program to the memory card or combined memory/battery card. (If the memorycard is from an incompatible 0BA0..0BA4 version, LOGO! displays this message: "Card unknown/ Press ESC".)

When LOGO! has finished copying, it automatically returns you to the main menu:

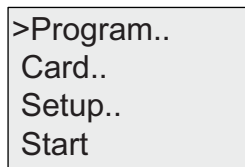

The circuit program backup is now stored on your memory card or combined memory/battery card and you can remove the card. **Do not forget** to replace the cap.

If power fails while LOGO! is copying the circuit program, repeat the process after Power On.

Note

The password of a protected circuit program in LOGO! also applies to the copied program version on your memory card or combined memory/battery card.

6.4 Copying data from the memory card to LOGO!

You can copy a circuit program from a compatible memory card or combined memory/battery card to LOGO! in one of two ways:

- Automatically during the startup of LOGO! (POWER ON)
- By means of the "Card" menu of LOGO!

Note

If the program on the module/card is protected with a password, the copied program in LOGO! is also protected with the same password.

Automatic copying during the startup of LOGO!

Proceed as follows:

1. Switch off the power supply to LOGO! (POWER OFF)
2. Remove the slot cover.
3. Insert the program module/card into the relevant slot.
4. Switch on the power supply to LOGO!

LOGO! copies the program from the program module/card to LOGO!. (If the memorycard is from an incompatible 0BA0..0BA3 version, LOGO! displays this message: "Unknown Card / Press ESC".)

When LOGO! has finished copying, it opens the main menu:

```
>Program..
Card..
Setup..
Start
```

Note

Before you switch LOGO! to RUN, you must ensure that the system you are controlling with LOGO! does not represent a source of hazard.

5. Move the '>' cursor to '**Start**': Press ▲ or ▼
6. Press **OK**.

Copying by means of the "Card" menu

For information on the replacement of a memory card or combined memory/battery card, also note the information in the topic "Inserting and removing memory and battery cards (Page 227)".

To copy a program from the memory card or combined memory/battery card to LOGO!:

1. Insert the memory card or combined memory/battery card
2. Switch LOGO! to programming mode (ESC / >Stop).

```
>Program..
  Card..
  Setup..
  Start
```

3. Move the '>' cursor to '**Card**': Press ▲ or ▼
4. Press **OK**. The transfer menu opens.
5. Move the '>' cursor to '**Card → LOGO**': Press ▲ or ▼

```
☒→ Card
>Card →☒
CopyProtect
```

☒ = LOGO!

6. Press **OK**.

LOGO! copies the circuit program from the memory card or combined memory/battery card to LOGO!. (If the memory card is from an incompatible 0BA0..0BA3 version, LOGO! displays this message: "Unknown Card / Press ESC".)

When LOGO! has finished copying, it automatically returns to the main menu.

LOGO! software

7.1 LOGO! software

LOGO!Soft Comfort is available as a programming package for the PC. This software provides many features, for example:

- A graphic interface for offline creation of your circuit program by means of Ladder Diagram (contact chart / circuit diagram) or Function Block Diagram (function chart)
- Simulation of your circuit program on the PC
- Generating and printing of an overview chart for the circuit program
- Saving a backup of the circuit program on the hard drive or other media
- Comparing circuit programs
- Easy configuration of blocks
- Transferring the circuit program in both directions:
 - from LOGO! to the PC
 - from the PC to LOGO!
- Reading the values of the hour counter
- Setting the time of day
- Summertime/wintertime conversion
- Online test: Display of status changes and process variables of LOGO! in RUN mode:
 - Status of a digital I/O, flags, shift register bits and cursor keys
 - The values of all analog I/Os and flags
 - The results of all blocks
 - The current values (including the times) of selected blocks
- Starting and stopping circuit program execution via the PC (RUN, STOP)

The LOGO! alternatives

As you can see, LOGO!Soft Comfort represents an alternative to conventional engineering methods, with several advantages:

- You can develop the circuit program on your PC.
- You simulate the circuit program on your computer and verify its functions before you actually implement it in your system.
- You can add comments to the circuit program and create hard copies.
- You can save a copy of your circuit program to the file system on your PC, to make it directly available for modifications.
- It takes only a few key actions to download the circuit program to LOGO!.

LOGO!SoftComfort

LOGO!Soft Comfort runs under Windows Vista®, Windows 98®, Windows NT 4.0®, Windows Me®, Windows 2000®, Windows XP®, Linux®, and Mac OS X®. LOGO!Soft Comfort is capable of client/server operation and offers you a high degree of freedom and comfort for creating your circuit program.

LOGO!Soft Comfort V6.1

This is the current version of LOGO!Soft Comfort. You will find all the functions and the functionality of the devices described in this manual in the Version 6.1.

Upgrading previous LOGO!Soft Comfort versions

You can use the Upgrade to LOGO!Soft Comfort V6.1 software to upgrade LOGO!Soft Comfort V1.0, V2.0, V3.0, V4.0 or V5.0 to V6.1.

Order numbers are found in the Appendix topic "Order numbers".

Note

If a full version is not installed, you can carry out an upgrade as follows:

- Install the new software from the CD.
 - When the system prompts you for the previous version, place the old LOGO!Soft Comfort CD in the CD drive.
 - Point your browser to the "...\Tools\Application" directory on the CD.
-

Updates and info

You can download demo versions of the software free of charge from the Internet address specified in the preface.

For detailed information on updates, upgrades and the LOGO!Soft Comfort Update Center, refer to the LOGO!Soft Comfort online help.

7.2 Connecting LOGO! to a PC

Connecting the PC cable

To connect LOGO! to a PC, you need the LOGO! PC cable. See the Appendix "Order numbers (Page 277)".

Turn the power off to the LOGO! Basic module. Remove the cap, memory card, or combined memory/battery card from your LOGO! and connect the cable to this socket. Connect the other end of the cable to the serial port of your PC.

Connecting the USB PC cable

You can also connect LOGO! to the PC with the LOGO! USB PC cable. For the cable's order number, refer to the Appendix "Order numbers (Page 277)".

Remove the cap or memory card, battery card, or combined memory/battery card from your LOGO! and connect the cable to this socket. Connect the other end of the cable to a USB port of your PC.

Switching LOGO! to PC ↔ LOGO! mode

Switch the LOGO! with/without display to STOP from your PC (refer to the LOGO!Soft Comfort online help), or select the ESC / >Stop command on a device with display and confirm the entry with 'Yes'.

When LOGO! is in STOP and online with the PC, the following PC commands are accepted:

- Switch LOGO! to RUN
- Read/write the circuit program
- Read/write the summertime/wintertime

When you start the upload/download in STOP, the following display appears automatically:

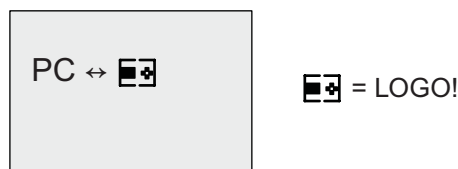

Note

You can switch earlier versions up to 0BA3 with/without display to PC ↔ LOGO mode as follows:

1. Switch off the power supply to LOGO!.
2. Remove the cover or the memory, battery, or combined memory/battery card and connect the cable to this socket.
3. Switch on power.

LOGO! switches automatically to PC ↔ LOGO mode.

The PC can now access LOGO! For information on this function, refer to the LOGO!Soft Comfort Online Help.

For more information on LOGO! versions without display, refer to the Appendix topic "LOGO! without display (Page 269)".

Closing the PC ↔ LOGO! mode

When the data transfer is completed, the connection to the PC is shut down automatically.

Note

If the circuit program created with LOGO!Soft Comfort is password protected, both the circuit program and the password are downloaded to LOGO!. The password prompt is enabled at the end of the data transfer.

The upload of a password protected program created in LOGO! is only possible after the correct password is entered in LOGO!Soft Comfort.

Applications

Note

LOGO! sample applications are available to all our customers free of charge on the Siemens LOGO! website (<http://www.siemens.com/logo>) (go to Products & Solutions → Applications → Application Examples).

The examples provided are not guaranteed to be error-free; they serve as general information about the fields of application for LOGO!, and may be different from user-specific solutions. Siemens reserves the right to make changes.

The user operates the system at his own responsibility. For safety concerns, refer to the relevant national standards and system-related installation regulations.

On the Internet you can find the following sample applications, tips for further applications, and more:

- Irrigation system for greenhouse plants
- Conveyor control system
- Bending machine control system
- Shop window lighting
- Bell system (e.g., in a school)
- Parking lot surveillance
- Outdoor lighting
- Shutter control system
- Domestic outdoor and indoor lighting system
- Control system of a cream stirrer
- Sports hall lighting
- Constant load on 3 consumers
- Sequential control system for cable-welding machines for large cross-sections
- Step switch (e.g., for fans)
- Sequential control for boilers
- Control system for several pump sets with centralized operator control
- Cutting device (e.g., for detonating fuses)
- Monitoring periods of utilization, for example of a solar energy system
- Intelligent foot switches, for example, for speed preselection)
- Elevating platform controls
- Impregnation of textiles, heating and conveyor belt controls
- Silo-filling system
- Fill station with message text on the LOGO! TD that displays the sum of counted objects

On the Web you can also find descriptions and the corresponding circuit diagrams of the applications. You can read these *.pdf files with the Adobe Acrobat Reader. If you have installed LOGO!Soft Comfort on your computer, you can simply click the disk icon to download the relevant circuit programs, which you can then adapt to suit your application and download to LOGO! directly via the PC cable.

Benefits of LOGO!

LOGO! is a particularly useful feature:

- For replacing auxiliary switchgear with the integrated LOGO! functions
- For saving wiring and installation work - because LOGO! keeps the wiring "in its head."
- For reducing space requirements for components in the control cabinet/distribution box. A smaller control cabinet/distribution box may provide sufficient space.
- For adding or changing functions, without having to install additional switchgear or change the wiring.
- For offering your customers new, additional functions for domestic and commercial housing installations. Examples:
 - Domestic security systems: LOGO! switches on a lamp at regular intervals or opens and closes the shutters while you are on holiday.
 - Central heating: LOGO! runs the circulation pump only when water or heating is actually required.
 - Refrigerating systems: LOGO! can defrost refrigerating systems at regular intervals to save energy costs.
 - You can illuminate aquaria and terraria on a time-dependent basis.

Last but not least, you can:

- Use commonly available switches and pushbuttons, which makes it easy to install a domestic system.
- Connect LOGO! directly to your domestic installation; the integrated power supply makes it possible.

Do you want more Info?

For more information about LOGO!, see our web page. The current URL is in the Preface (Page 3).

Do you have any suggestions?

There are definitely many more useful applications for LOGO!. If you know of one, why not write to us? We will collect all the suggestions made and distribute as many of them as we can. No matter whether your LOGO! circuit is particularly complex or simple, simply write to us. We shall be delighted to receive all your suggestions.

Write to:

Siemens AG
A&D AS FA PS4
PO box 48 48
D-90327 Nuremberg

Technical data

A.1 General technical data

Criterion	Tested in accordance with	Values
LOGO! Basic Dimensions (WxHxD) Weight Installation		72 x 90 x 55 mm Approx. 190 g on a 35 mm profile rail 4 module widths or wall mounting
LOGO! expansion modules DM8..., AM... Dimensions (WxHxD) Weight Installation		36 x 90 x 53 mm Approx. 90 g on a 35 mm profile rail 2 module widths or wall mounting
LOGO! TD (Text Display)		128.2 x 86 x 38.7 mm Approx. 220g Bracket mounting
LOGO! expansion modules DM16... Dimensions (WxHxD) Weight Installation		72 x 90 x 53 mm Approx. 190 g on a 35 mm profile rail 4 module widths or wall mounting
Climatic conditions		
Ambient temperature Horizontal installation Vertical installation	Low temperature to IEC 60068-2-1 High temperature to IEC 60068-2-2	0 ... 55 °C 0 ... 55 °C
Storage/shipping		- 40 °C... +70 °C
Relative humidity	IEC 60068-2-30	From 10 to 95 % no condensation
Air pressure		795 ... 1080 hPa
Pollutants	IEC 60068-2-42 IEC 60068-2-43	SO ₂ 10 cm ³ /m ³ , 10 days H ₂ S 1 cm ³ /m ³ , 10 days
Ambient mechanical conditions		
Degree of protection		IP 20 for LOGO! Basic module front panel IP 65 for LOGO! TD front panel
Vibrations:	IEC 60068-2-6	5 ... 8.4 Hz (constant amplitude 3.5 mm) 8.4 ... 150 Hz (constant acceleration 1 g)
Shock	IEC 60068-2-27	18 shocks (half-sine wave 15g/11 ms)
Free fall (packaged)	IEC 60068-2-32	0.3 m

A.1 General technical data

Criterion	Tested in accordance with	Values
Electromagnetic compatibility (EMC)		
Noise emission	EN 55011/A EN 55022/B EN 50081-1 (domestic area)	Limit class B group 1
Electrostatic discharge	IEC 61000-4-2 Severity 3	8 kV air discharge 6 kV contact discharge
Electromagnetic fields	IEC 61000-4-3	Field strength 1 V/m and 10 V/m
HF currents on cables and cable shielding	IEC 61000-4-6	10 V
Burst pulses	IEC 61000-4-4Severity 3	2 kV (supply and signal lines)
High-energy surge pulse (applies only to LOGO! 230 ...)	IEC 61000-4-5Severity 3	1 kV (power lines) symmetrical 2 kV (power lines) asymmetrical
Safety to IEC		
Clearance and creepage distance rating	IEC 60664, IEC 61131-2, EN 50178 cULus to UL 508, CSA C22.2 No. 142 With LOGO! 230 R/RC, also IEC60730-1	Fulfilled
Insulation strength	IEC 61131-2	Fulfilled
Cycle time		
Cycle time per function		< 0.1 ms
Startup		
Startup time at power-up		typ. 9 s

A.2 Technical data: LOGO! 230...

	LOGO! 230 RC LOGO! 230 RCo
Power supply	
Input voltage	115...240 V AC/DC
Permissible range	85 ... 265 V AC 100 ... 253 V DC
Permissible mains frequency	47 ... 63 Hz
Power consumption <ul style="list-style-type: none"> • 115 V AC • 240 V AC • 115 V DC • 240 V DC 	<ul style="list-style-type: none"> • 15 ... 40 mA • 15 ... 25 mA • 10 ... 25 mA • 6 ... 15 mA
Voltage failure buffering <ul style="list-style-type: none"> • 115 V AC/DC • 240 V AC/DC 	<ul style="list-style-type: none"> • typ. 10 ms • typ. 20 ms
Power loss at <ul style="list-style-type: none"> • 115 V AC • 240 V AC • 115 V DC • 240 V DC 	<ul style="list-style-type: none"> • 1.7 ... 4.6 W • 3.6 ... 6.0 W • 1.1... 2.9 W • 1.4 ... 3.6 W
Backup of the real-time clock at 25 °C	typ. 80 hours without battery card typ. 2 years with battery card
Accuracy of the real-time clock	typ. ± 2 s / day
Digital inputs	
Number	8
Electrical isolation	No
Number of high speed inputs	0
Input frequency <ul style="list-style-type: none"> • Normal input • High speed input 	<ul style="list-style-type: none"> • max. 4 Hz • --
Input voltage L1 <ul style="list-style-type: none"> • Signal 0 • Signal 1 • Signal 0 • Signal 1 	<ul style="list-style-type: none"> • < 40 V AC • > 79 V AC • < 30 V DC • > 79 V DC
Input current at <ul style="list-style-type: none"> • Signal 0 • Signal 1 • Signal 0 • Signal 1 	<ul style="list-style-type: none"> • < 0.03 mA AC • > 0.08 mA AC • < 0.03 mA DC • > 0.12 mA DC

	LOGO! 230 RC LOGO! 230 RC _o
Delay time at 0 to 1: <ul style="list-style-type: none"> • 120V AC • 240 V AC • 120 V DC • 240V DC 	<ul style="list-style-type: none"> • typ. 50 ms • typ. 30 ms • typ. 25 ms • typ. 15 ms
Delay time at 1 to 0: <ul style="list-style-type: none"> • 120V AC • 240 V AC • 120 V DC • 240V DC 	<ul style="list-style-type: none"> • typ. 65 ms • typ. 105 ms • typ. 95 ms • typ. 125 ms
Line length (unshielded)	100 m
Digital outputs	
Number	4
Output type	Relay outputs
Electrical isolation	Yes
In groups of	1
Control of a digital input	Yes
Continuous current I _{th}	max. 10 A per relay
Surge current Incandescent lamp load (25000 switching cycles) at <ul style="list-style-type: none"> • 230/240 V AC • 115/120 V AC 	max. 30 A <ul style="list-style-type: none"> • 1000 W • 500 W
Fluorescent tubes with ballast (25000 switching cycles)	10 x 58 W (at 230/240 V AC)
Fluorescent tubes, conventionally compensated (25000 switching cycles)	1 x 58 W (at 230/240 V AC)
Fluorescent tubes, uncompensated (25000 switching cycles)	10 x 58 W (at 230/240 V AC)
Short circuit-proof cos 1	Power protection B16, 600A
Short circuit-proof cos 0.5 to 0.7	Power protection B16, 900A
Derating	none; across the entire temperature range
Parallel output circuits for power increase	Not permitted
Protection of output relay (if desired)	max. 16 A, characteristic B16
Switching rate	
Mechanical	10 Hz
Ohmic load/lamp load	2 Hz
Inductive load	0.5 Hz

Notice: For fluorescent lamps with capacitors, the technical data of fluorescent lamp ballasts must also be considered. If the maximum allowed surge current is exceeded, fluorescent lamps must be switched with appropriate contactor relays.

The data was determined with the following devices:
 Siemens fluorescent tubes 58W VVG 5LZ 583 3-1 uncompensated.
 Siemens fluorescent tubes 58W VVG 5LZ 583 3-1 parallel compensated with 7µF.
 Siemens fluorescent tubes 58W VVG 5LZ 501 1-1N with ballast.

A.3 Technical data: LOGO! DM8 230R and LOGO! DM16 230R

	LOGO! DM8 230R	LOGO! DM16 230R
Power supply		
Input voltage	115...240 V AC/DC	115 ... 240 V AC/DC
Permissible range	85 ... 265 V AC 100 ... 253 V DC	85 ... 265 V AC 100 ... 253 V DC
Permissible mains frequency	47 ... 63 Hz	
Power consumption		
<ul style="list-style-type: none"> • 115 V AC • 240 V AC • 115 V DC • 240 V DC 	<ul style="list-style-type: none"> • 10 ... 30 mA • 10 ... 20 mA • 5 ... 15 mA • 5 ... 10 mA 	<ul style="list-style-type: none"> • 10 ... 60 mA • 10 ... 40 mA • 5 ... 25 mA • 5 ... 20 mA
Voltage failure buffering		
<ul style="list-style-type: none"> • 115 V AC/DC • 240 V AC/DC 	<ul style="list-style-type: none"> • typ. 10 ms • typ. 20 ms 	<ul style="list-style-type: none"> • typ. 10 ms • typ. 20 ms
Power loss at		
<ul style="list-style-type: none"> • 115 V AC • 240 V AC • 115 V DC • 240 V DC 	<ul style="list-style-type: none"> • 1.1 ... 3.5 W • 2.4 ... 4.8 W • 0.5 ... 1.8 W • 1.2 ... 2.4 W 	<ul style="list-style-type: none"> • 1.1 ... 4.5 W • 2.4 ... 5.5 W • 0.6 ... 2.9 W • 1.2 ... 4.8 W
Digital inputs		
Number	4	8
Electrical isolation	No	No
Number of high speed inputs	0	0
Input frequency		
<ul style="list-style-type: none"> • Normal input • High speed input 	<ul style="list-style-type: none"> • max. 4 Hz • -- 	<ul style="list-style-type: none"> • max. 4 Hz • --
Input voltage L1		
<ul style="list-style-type: none"> • Signal 0 • Signal 1 • Signal 0 • Signal 1 	<ul style="list-style-type: none"> • < 40 V AC • > 79 V AC • < 30 V DC • > 79 V DC 	<ul style="list-style-type: none"> • < 40 V AC • > 79 V AC • < 30 V DC • > 79 V DC
Input current at		
<ul style="list-style-type: none"> • Signal 0 • Signal 1 • Signal 0 • Signal 1 	<ul style="list-style-type: none"> • < 0.03 mA AC • > 0.08 mA AC • < 0.03 mA DC • > 0.12 mA DC 	<ul style="list-style-type: none"> • < 0.05 mA AC • > 0.08 mA AC • < 0.05 mA DC • > 0.12 mA DC
Delay time at 0 to 1:		
<ul style="list-style-type: none"> • 120V AC • 240 V AC • 120 V DC • 240V DC 	<ul style="list-style-type: none"> • typ. 50 ms • typ. 30 ms • typ. 25 ms • typ. 15 ms 	<ul style="list-style-type: none"> • typ. 50 ms • typ. 30 ms • typ. 25 ms • typ. 15 ms
Delay time at 1 to 0:		
<ul style="list-style-type: none"> • 120V AC • 240 V AC • 120 V DC • 240V DC 	<ul style="list-style-type: none"> • typ. 65 ms • typ. 105 ms • typ. 95 ms • typ. 125 ms 	<ul style="list-style-type: none"> • typ. 65 ms • typ. 105 ms • typ. 95 ms • typ. 125 ms

	LOGO! DM8 230R	LOGO! DM16 230R
Line length (unshielded)	100 m	100 m
Digital outputs		
Number	4	8
Output type	Relay outputs	Relay outputs
Electrical isolation	Yes	Yes
In groups of	1	1
Control of a digital input	Yes	Yes
Continuous current I _{th}	max. 5 A per relay	max. 5 A per relay
Surge current	max. 30 A	max. 30 A
Incandescent lamp load (25000 switching cycles) at: 230/240 V AC 115/120 V AC	1000 W 500 W	1000 W 500 W
Fluorescent tubes with ballast (25000 switching cycles)	10 x 58 W (at 230/240 V AC)	10 x 58 W (at 230/240 V AC)
Fluorescent tubes, conventionally compensated (25000 switching cycles)	1 x 58 W (at 230/240 V AC)	1 x 58 W (at 230/240 V AC)
Fluorescent tubes, uncompensated (25000 switching cycles)	10 x 58 W (at 230/240 V AC)	10 x 58 W (at 230/240 V AC)
Short circuit-proof cos 1	Power protection B16, 600A	Power protection B16, 600A
Short circuit-proof cos 0.5 to 0.7	Power protection B16, 900A	Power protection B16, 900A
Derating	none; across the entire temperature range	none; across the entire temperature range
Parallel output circuits for power increase	Not permitted	Not permitted
Protection of output relay (if desired)	max. 16 A, characteristic B16	max. 16 A, characteristic B16
Switching rate		
Mechanical	10 Hz	10 Hz
Ohmic load/lamp load	2 Hz	2 Hz
Inductive load	0.5 Hz	0.5 Hz

Notice: For fluorescent lamps with capacitors, the technical data of fluorescent lamp ballasts must also be considered. If the maximum allowed surge current is exceeded, fluorescent lamps must be switched with appropriate contactor relays.

The data was determined with the following devices:

Siemens fluorescent tubes 58W VVG 5LZ 583 3-1 uncompensated.

Siemens fluorescent tubes 58W VVG 5LZ 583 3-1 parallel compensated with 7µF.

Siemens fluorescent tubes 58W VVG 5LZ 501 1-1N with ballast.

A.4 Technical data: LOGO! 24...

	LOGO! 24 LOGO! 24o
Power supply	
Input voltage	24 V DC
Permissible range	20.4 ... 28.8 V DC
Reverse polarity protection	Yes
Permissible mains frequency	- -
Power consumption from 24 V DC	40 ... 75 mA 0.3 A per output
Voltage failure buffering	
Power loss at 24 V	1.0 ... 1.8 W
Backup of the real-time clock at 25 °C	no clock available
Accuracy of the real-time clock	no clock available
Digital inputs	
Number	8
Electrical isolation	No
Number of high speed inputs	4 (I3, I4, I5, I6)
Input frequency	<ul style="list-style-type: none"> • Normal input • High speed input
Input voltage	L+
Signal 0	< 5 V DC
Signal 1	> 12 V DC
Input current at	
Signal 0	< 0.85 mA (I3...I6) < 0.05 mA (I1, I2, I7, I8)
Signal 1	> 2 mA (I3... I6) > 0.15 mA (I1, I2, I7, I8)
Delay time at	
0 to 1	typ. 1.5 ms <1.0 ms (I3 ... I6)
1 to 0	typ. 1.5 ms <1.0 ms (I3 ... I6)
Line length (unshielded)	100 m
Analog inputs	
Number	4 (I1=AI3, I2=AI4, I7=AI1, I8=AI2)
Range	0 ... 10 V DC input impedance 72 kΩ
Cycle time for analog value generation	300 ms
max. input voltage	28.8 V
Line length (shielded and twisted)	10 m
Error limit	± 1.5% at FS
Digital outputs	
Number	4

	LOGO! 24 LOGO! 24o
Output type	Transistor, current-sourcing ¹⁾
Electrical isolation	No
In groups of	--
Control of a digital input	Yes
Output voltage	± Supply voltage
Output current	max. 0.3 A
Short circuit-proof and overload-proof	Yes
Short circuit current limitation	Approx. 1 A
Derating	none; across the entire temperature range
Short circuit-proof cos 1	--
Short circuit-proof cos 0.5 to 0.7	--
Parallel output circuit for power increase	Not permitted
Protection of output relay (if desired)	--
Switching rate ²⁾	
Mechanical	--
Electrical	10 Hz
Ohmic load/lamp load	10 Hz
Inductive load	0.5 Hz

1) When LOGO! 24, LOGO! 24o, LOGO! DM8 24 or LOGO! DM16 24 are switched on, signal 1 is sent to the digital outputs for about 50 microseconds. Take this into account, especially when using devices that react to short pulses.

2) The maximum switching rate is only dependent on the switching program's cycle time.

A.5 Technical data: LOGO! DM8 24 and LOGO! DM16 24

	LOGO! DM8 24	LOGO! DM16 24
Power supply		
Input voltage	24 V DC	24 V DC
Permissible range	20.4 ... 28.8 V DC	20.4 ... 28.8 V DC
Reverse polarity protection	Yes	Yes
Permissible mains frequency	--	--
Power consumption from 24 V DC	30 ... 45 mA 0.3 A per output	30 ... 45 mA 0.3 A per output
Power loss at 24 V	0.8 ... 1.1 W	0.8 ... 1.7 W
Backup of the real-time clock at 25 °C	no clock available	no clock available
Accuracy of the real-time clock	no clock available	no clock available
Digital inputs		
Number	4	8
Electrical isolation	No	No
Number of high speed inputs	0	0
Input frequency		
• Normal input	• max. 4 Hz	• max. 4 Hz
• High speed input	• --	• --
Input voltage	L+	L+
• Signal 0	• < 5 V DC	• < 5 V DC
• Signal 1	• > 12 V DC	• > 12 V DC
Input current at		
• Signal 0	• < 0.85 mA	• < 0.85 mA
• Signal 1	• > 2 mA	• > 2 mA
Delay time at		
• 0 to 1	• typ. 1.5 ms	• typ. 1.5 ms
• 1 to 0	• typ. 1.5 ms	• typ. 1.5 ms
Line length (unshielded)	100 m	100 m
Digital outputs		
Number	4	8
Output type	Transistor, current-sourcing ¹⁾	Transistor, current-sourcing ⁽¹⁾
Electrical isolation	No	No
In groups of	--	--
Control of a digital input	Yes	Yes
Output voltage	± Supply voltage	± Supply voltage
Output current	max. 0.3 A	max. 0.3 A
Short circuit-proof and overload-proof	Yes	Yes
Short circuit current limitation	Approx. 1 A	Approx. 1 A

	LOGO! DM8 24	LOGO! DM16 24
Derating	none; across the entire temperature range	none; across the entire temperature range
Short circuit-proof cos 1	--	--
Short circuit-proof cos 0.5 to 0.7	--	--
Parallel output circuit for power increase	Not permitted	Not permitted
Protection of output relay (if desired)	--	--
Switching rate		
Mechanical	--	--
Electrical	10 Hz	10 Hz
Ohmic load/lamp load	10 Hz	10 Hz
Inductive load	0.5 Hz	0.5 Hz

- 1) When LOGO! 24, LOGO! 24o, LOGO! DM8 24 or LOGO! DM16 24 are switched on, signal 1 is sent to the digital outputs for about 50 microseconds. Take this into account, especially when using devices that react to short pulses.

A.6 Technical data: LOGO! 24RC...

	LOGO! 24RC LOGO! 24RCo	
Power supply		
Input voltage	24 V AC/DC	
Permissible range	20.4 ... 26.4 V AC 20.4 ... 28.8 V DC	
Reverse polarity protection	--	
Permissible mains frequency	47 ... 63 Hz	
Power consumption	<ul style="list-style-type: none"> • 24 V AC • 24 V DC 	<ul style="list-style-type: none"> • 45 ... 130 mA • 40 ... 100 mA
Voltage failure buffering	typ. 5 ms	
Power loss	<ul style="list-style-type: none"> • 24 V AC • 24 V DC 	<ul style="list-style-type: none"> • 1.1... 3.1 W • 1.0 ... 2.4 W
Backup of the real-time clock at 25 °C	typ. 80 hours without battery card typ. 2 years with battery card	
Accuracy of the real-time clock	typ. ± 2 s / day	
Digital inputs		
Number	8, optional P action or N action	
Electrical isolation	No	
Number of high speed inputs	0	
Input frequency	<ul style="list-style-type: none"> • Normal input • High speed input 	<ul style="list-style-type: none"> • max. 4 Hz • --
Input voltage	L	<ul style="list-style-type: none"> • < 5 V AC/DC • > 12 V AC/DC
Input current at	<ul style="list-style-type: none"> • Signal 0 • Signal 1 	<ul style="list-style-type: none"> • < 1.0 mA • > 2.5 mA
Delay time at	<ul style="list-style-type: none"> • 0 to 1 • 1 to 0 	<ul style="list-style-type: none"> • typ. 1.5 ms • typ. 15 ms
Line length (unshielded)	100 m	
Analog inputs		
Number	--	
Range	--	
max. Input voltage	--	
Digital outputs		
Number	4	

	LOGO! 24RC LOGO! 24RCo
Output type	Relay outputs
Electrical isolation	Yes
In groups of	1
Control of a digital input	Yes
Continuous current I_{th}	max. 10 A per relay
Surge current	max. 30 A
Incandescent lamp load (25000 switching cycles) at	1000 W
Fluorescent tubes with ballast (25000 switching cycles)	10 x 58 W
Fluorescent tubes, conventionally compensated (25000 switching cycles)	1 x 58 W
Fluorescent tubes, uncompensated (25000 switching cycles)	10 x 58 W
Derating	none; across the entire temperature range
Short circuit-proof cos 1	Power protection B16, 600A
Short circuit-proof cos 0.5 to 0.7	Power protection B16, 900A
Parallel output circuits for power increase	Not permitted
Protection of output relay (if desired)	max. 16 A, characteristic B16
Switching rate	
Mechanical	10 Hz
Ohmic load/lamp load	2 Hz
Inductive load	0.5 Hz

Notice: For fluorescent lamps with capacitors, the technical data of fluorescent lamp ballasts must also be considered. If the maximum allowed surge current is exceeded, fluorescent lamps must be switched with appropriate contactor relays.

The data was determined with the following devices:

Siemens fluorescent tubes 58W VVG 5LZ 583 3-1 uncompensated.

Siemens fluorescent tubes 58W VVG 5LZ 583 3-1 parallel compensated with 7µF.

Siemens fluorescent tubes 58W VVG 5LZ 501 1-1N with ballast.

A.7 Technical data: LOGO! DM8 24R and LOGO! DM16 24R

	LOGO! DM8 24 R	LOGO! DM16 24R
Power supply		
Input voltage	24 V AC/DC	24 V DC
Permissible range	20.4 ... 26.4 V AC 20.4 ... 28.8 V DC	20.4 ... 28.8 V DC
Reverse polarity protection	--	--
Permissible mains frequency	47 ... 63 Hz	
Power consumption	<ul style="list-style-type: none"> • 24 V AC • 24 V DC 	<ul style="list-style-type: none"> • 30 ... 90 mA
Voltage failure buffering	typ. 5 ms	typ. 5 ms
Power loss	<ul style="list-style-type: none"> • 24 V AC • 24 V DC 	<ul style="list-style-type: none"> • 0.7 ... 2.5 W
Digital inputs		
Number	4, optional P action or N action	8
Electrical isolation	No	No
Number of high speed inputs	0	0
Input frequency	<ul style="list-style-type: none"> • Normal input • High speed input 	<ul style="list-style-type: none"> • max. 4 Hz • --
Input voltage	L	<ul style="list-style-type: none"> • < 5 V DC • > 12 V DC
Input current at	<ul style="list-style-type: none"> • Signal 0 • Signal 1 	<ul style="list-style-type: none"> • < 1.0 mA • > 2.0 mA
Delay time at	<ul style="list-style-type: none"> • 0 to 1 • 1 to 0 	<ul style="list-style-type: none"> • typ. 1.5 ms • typ. 1.5 ms
Line length (unshielded)	100 m	100 m
Digital outputs		
Number	4	8
Output type	Relay outputs	Relay outputs
Electrical isolation	Yes	Yes
In groups of	1	1
Control of a digital input	Yes	Yes
Continuous current I_{th}	max. 5 A per relay	max. 5 A per relay
Surge current	max. 30 A	max. 30 A
Incandescent lamp load (25000 switching cycles) at	1000 W	1000 W

Technical data

A.7 Technical data: LOGO! DM8 24R and LOGO! DM16 24R

	LOGO! DM8 24 R	LOGO! DM16 24R
Fluorescent tubes with ballast (25000 switching cycles)	10 x 58 W	10 x 58 W
Fluorescent tubes, conventionally compensated (25000 switching cycles)	1 x 58 W	1 x 58 W
Fluorescent tubes, uncompensated (25000 switching cycles)	10 x 58 W	10 x 58 W
Derating	none; across the entire temperature range	none; across the entire temperature range
Short circuit-proof cos 1	Power protection B16, 600A	Power protection B16, 600A
Short circuit-proof cos 0.5 to 0.7	Power protection B16, 900A	Power protection B16, 900A
Parallel output circuits for power increase	Not permitted	Not permitted
Protection of output relay (if desired)	max. 16 A, characteristic B16	max. 16 A, characteristic B16
Switching rate		
Mechanical	10 Hz	10 Hz
Ohmic load/lamp load	2 Hz	2 Hz
Inductive load	0.5 Hz	0.5 Hz

Notice: For fluorescent lamps with capacitors, the technical data of fluorescent lamp ballasts must also be considered. If the maximum allowed surge current is exceeded, fluorescent lamps must be switched with appropriate contactor relays.

The data was determined with the following devices:

Siemens fluorescent tubes 58W VVG 5LZ 583 3-1 uncompensated.

Siemens fluorescent tubes 58W VVG 5LZ 583 3-1 parallel compensated with 7µF.

Siemens fluorescent tubes 58W VVG 5LZ 501 1-1N with ballast.

A.8 Technical data: LOGO! 12/24... LOGO! DM8 12/24R

	LOGO! 12/24RC LOGO! 12/24RCo	LOGO! DM8 12/24R
Power supply		
Input voltage	12/24 V DC	12/24 V DC
Permissible range	10.8 ... 28.8 V DC	10.8 ... 28.8 V DC
Reverse polarity protection	Yes	Yes
Power consumption		
<ul style="list-style-type: none"> • 12 V DC • 24 V DC 	<ul style="list-style-type: none"> • 60 ... 175 mA • 40 ... 100mA 	<ul style="list-style-type: none"> • 30 ... 140 mA • 20 ... 75 mA
Voltage failure buffering		
<ul style="list-style-type: none"> • 12 V DC • 24 V DC 	<ul style="list-style-type: none"> • typ. 2 ms • typ. 5 ms 	<ul style="list-style-type: none"> • typ. 2 ms • typ. 5 ms
Power loss		
<ul style="list-style-type: none"> • 12 V DC • 24 V DC 	<ul style="list-style-type: none"> • 0.7 ... 2.1 W • 1.0 ... 2.4 W 	<ul style="list-style-type: none"> • 0.3 ... 1.7 W • 0.4 ... 1.8 W
Backup of the real-time clock at 25 °C	typ. 80 hours without battery card typ. 2 years with battery card	--
Accuracy of the real-time clock	typ. ± 2 s / day	--
Electrical isolation	No	No
Digital inputs		
Number	8	4
Electrical isolation	No	No
Number of high speed inputs	4 (I3, I4, I5, I6)	0
Input frequency		
<ul style="list-style-type: none"> • Normal input • High speed input 	<ul style="list-style-type: none"> • Max. 4 Hz • Max. 5 kHz 	<ul style="list-style-type: none"> • max. 4 Hz • --
Input voltage L+		
<ul style="list-style-type: none"> • Signal 0 • Signal 1 	<ul style="list-style-type: none"> • < 5 V DC • > 8.5 V DC 	<ul style="list-style-type: none"> • < 5 V DC • > 8.5 V DC
Input current at		
<ul style="list-style-type: none"> • Signal 0 • Signal 1 	<ul style="list-style-type: none"> < 0.85 mA (I3...I6) < 0.05 mA (I1, I2, I7, I8) > 1.5 mA (I3... I6) > 0.1 mA (I1, I2, I7, I8) 	<ul style="list-style-type: none"> < 0.85 mA > 1.5 mA
Delay time at		
<ul style="list-style-type: none"> • 0 to 1 • 1 to 0 	<ul style="list-style-type: none"> typ. 1.5 ms <1.0 ms (I3 ... I6) typ. 1.5 ms <1.0 ms (I3 ... I6) 	<ul style="list-style-type: none"> typ. 1.5 ms typ. 1.5 ms
Line length (unshielded)	100 m	100 m
Analog inputs		
Number	4 (I1=AI3, I2=AI4, I7=AI1, I8=AI2)	--

	LOGO! 12/24RC LOGO! 12/24RCo	LOGO! DM8 12/24R
Range	0 ... 10 V DC input impedance 72 kΩ	--
Cycle time for analog value generation	300 ms	--
max. Input voltage	28.8 V DC	--
Line length (shielded and twisted)	10 m	--
Error limit	± 1.5 % at FS	--
Digital outputs		
Number	4	4
Output type	Relay outputs	Relay outputs
Electrical isolation	Yes	Yes
In groups of	1	1
Control of a digital input	Yes	Yes
Continuous current I _{th} (per terminal)	max. 10 A per relay	max. 5 A per relay
Surge current	max. 30 A	max. 30 A
Incandescent lamp load (25000 switching cycles) at	1000 W	1000 W
Fluorescent tubes with ballast (25000 switching cycles)	10 x 58 W	10 x 58 W
Fluorescent tubes, conventionally compensated (25000 switching cycles)	1 x 58 W	1 x 58 W
Fluorescent tubes, uncompensated (25000 switching cycles)	10 x 58 W	10 x 58 W
Derating	none; across the entire temperature range	none; across the entire temperature range
Short circuit-proof cos 1	Power protection B16, 600A	Power protection B16, 600A
Short circuit-proof cos 0.5 to 0.7	Power protection B16, 900A	Power protection B16, 900A
Parallel output circuits for power increase	Not permitted	Not permitted
Protection of output relay (if desired)	max. 16 A, characteristic B16	max. 16 A, characteristic B16
Switching rate		
Mechanical	10 Hz	10 Hz
Ohmic load/lamp load	2 Hz	2 Hz
Inductive load	0.5 Hz	0.5 Hz

Notice: For fluorescent lamps with capacitors, the technical data of fluorescent lamp ballasts must also be considered. If the maximum allowed surge current is exceeded, fluorescent lamps must be switched with appropriate contactor relays.

The data was determined with the following devices:

Siemens fluorescent tubes 58W VVG 5LZ 583 3-1 uncompensated.

Siemens fluorescent tubes 58W VVG 5LZ 583 3-1 parallel compensated with 7µF.

Siemens fluorescent tubes 58W VVG 5LZ 501 1-1N with ballast.

A.9 Switching capacity/service life of the relay outputs

Switching capacity and service life of the contacts with ohmic loading (heating):

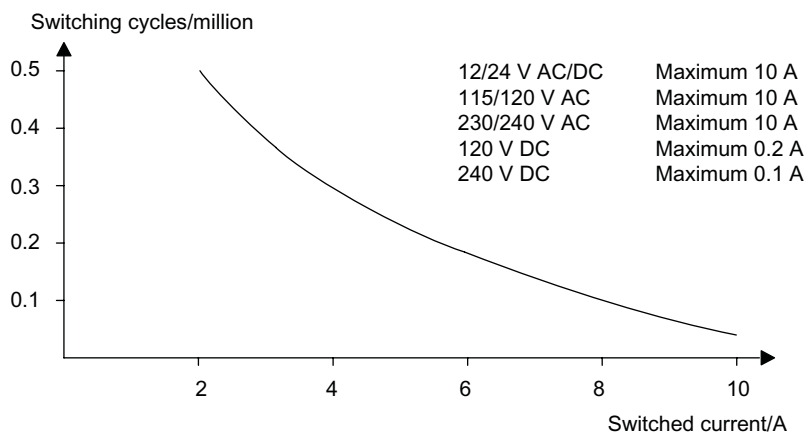

Switching capacity and service life of the contacts with high inductive load to IEC 947-5-1 DC 13/AC 15 (contactors, solenoid coils, motors):

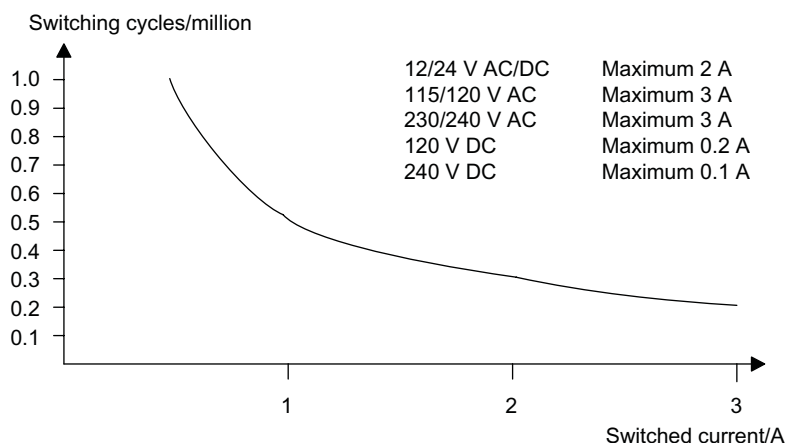

A.10 Technical data: LOGO! AM 2

LOGO! AM 2	
Power supply	
Input voltage	12/24 V DC
Permissible range	10.8 ... 28.8 V DC
Power consumption	25 ... 50 mA
Voltage failure buffering	typ. 5 ms
Power loss at	
<ul style="list-style-type: none"> • 12 V • 24 V 	<ul style="list-style-type: none"> • 0.3 ... 0.6 W • 0.6 ... 1.2 W
Electrical isolation	No
Reverse polarity protection	Yes
Ground terminal	for connecting ground and shielding of the analog measuring line
Analog inputs	
Number	2
Type	Unipolar
Input range	0 ... 10 V DC (input impedance 76 kΩ) or 0 ... 20 mA (input impedance <250 Ω)
Resolution	10 bit, normalized to 0 ... 1000
Cycle time for analog value generation	50 ms
Electrical isolation	No
Line length (shielded and twisted)	10 m
Encoder supply voltage	none
Error limit	± 1.5 %
Interference frequency suppression	55 Hz

A.11 Technical data: LOGO! AM 2 PT100

LOGO! AM 2 PT100	
Power supply	
Input voltage	12/24 V DC
Permissible range	10.8 ... 28.8 V DC
Power consumption	25 ... 50 mA
Voltage failure buffering	typ. 5 ms
Power loss at <ul style="list-style-type: none"> • 12 V • 24 V 	<ul style="list-style-type: none"> • 0.3 ... 0.6 W • 0.6 ... 1.2 W
Electrical isolation	No
Reverse polarity protection	Yes
Ground terminal	for connecting ground and shielding of the measuring line
Sensor inputs	
Number	2
Type	RTD Pt100
Connection of sensors <ul style="list-style-type: none"> • 2-wire technique • 3-wire technique 	<ul style="list-style-type: none"> • Yes • Yes
Measurement range	-50 °C... +200 °C -58 °F ... +392 °F
Settings for the measurement display on the basic module: <ul style="list-style-type: none"> • 1 °C steps • 0.25 °C steps (rounded to one decimal) • 1 °F steps • 0.25 °F steps (rounded to one decimal) 	<ul style="list-style-type: none"> • Offset: -50, Gain: 0.25 • Offset: -500, Gain: 2.50 • Offset: -58, Gain: 0.45 • Offset: -580, Gain: 4.50
Curve linearization	No
Measuring current I _c	1.1 mA
Measurement rate	depends on the installation typical: 50 ms
Resolution	0.25 °C
Error limits <ul style="list-style-type: none"> • 0 °C ... +200 °C • -50 °C ... +200 °C 	of the final measured value: <ul style="list-style-type: none"> • ±1.0 % • ± 1.5 %
Electrical isolation	No
Cable length (shielded)	10 m
Interference frequency suppression	55 Hz

A.12 Technical data: LOGO! AM 2 AQ (6ED1055 - 1MM00 - 0BA0)

LOGO! AM 2 AQ	
Power supply	
Input voltage	24 V DC
Permissible range	20.4 ... 28.8 V DC
Power consumption	25 ...50 mA
Voltage failure buffering	typ. 5 ms
Power loss at 24 V	0.6 ... 1.2 W
Electrical isolation	No
Reverse polarity protection	Yes
Ground terminal	for connecting ground and shielding of the analog output line.
Analog outputs	
Number	2
Voltage range	0 ... 10 V DC
Voltage load	≥5 kΩ
Resolution	10 bit, normalized to 0 ... 1000
Cycle time for analog output	depending on installation (50 ms)
Electrical isolation	No
Line length (shielded and twisted)	10 m
Error limit	± 2.5 % FS
Short circuit protection	Yes (affect neighboring voltage output)
Overload protection	Yes (affect neighboring voltage output)

A.13 Technical data: LOGO! AM 2 AQ (6ED1055 - 1MM00 - 0BA1)

LOGO! AM 2 AQ	
Power supply	
Input voltage	24 V DC
Permissible range	20.4 ... 28.8 V DC
Power consumption	35 ...90 mA
Voltage failure buffering	typ. 5 ms
Power loss at 24 V	0.9 ... 2.2 W
Electrical isolation	No
Reverse polarity protection	Yes
Ground terminal	for connecting ground and shielding of the analog output line.
Analog outputs	
Number	2
Voltage range	0 ... 10 V DC
Voltage load	≥5 kΩ
Current output	0/4...20mA
Current load	≤250 Ω
Resolution	10 bit, normalized to 0 ... 1000
Cycle time for analog output	depending on installation (50 ms)
Electrical isolation	No
Line length (shielded and twisted)	10 m
Error limit	Voltage output: ± 2.5 % FS Voltage output: ± 3 % FS
Short circuit protection	Voltage output: Yes (affect neighboring voltage output)
Overload protection	Voltage output: Yes (affect neighboring voltage output)

A.14 Technical data: CM EIB/KNX

CM EIB/KNX	
Mechanical data	
Dimensions (WxHxD)	36 x 90 x 55 mm
Weight	Approx. 107 g
Installation	on a 35 mm profile rail 2 module widths or wall mounting, must be mounted as the last module on the right of LOGO!
Power supply	
Input voltage	24 V AC/DC
Permissible range	-15% ... +10% AC -15% ... +20% DC
Power consumption from power supply	max. 25 mA
Power consumption via bus	5 mA
EIB data transmission rate	9600 baud
Connections	
Digital inputs (I)	virtual max. 16
Digital outputs (Q)	virtual max. 12
Analog inputs (AI)	virtual max. 8
Analog outputs (AQ)	virtual max. 2
Group addresses	max. 56
Associations	max. 56
Climatic conditions	
Climatic withstand capability	EN 50090-2-2
Ambient operating conditions	0 ... 55 °C natural convection
Storage and transport temperature	- 40 °C ... +70 °C
Relative humidity	95 % at +25 °C (not condensing)
Electrical safety	
Degree of protection	IP 20 (in accordance with EN 60529)
Interference suppression	EN 55011 (limit class B)
Certification	IEC 60730-1 IEC 61131-2
Overvoltage protection	Slow-blowing fuse 80 mA (recommended)
Electromagnetic compatibility (EMC)	
EMC requirements	Complies with EN 61000-6-1 and EN 61000-6-2
Approval	
	KNX/EIB certified UL 508 FM
CE mark	
	In accordance with the EMC guideline (residential and functional buildings), low voltage guideline

A.15 Technical data: CM AS Interface

CM AS Interface	
Mechanical data	
Dimensions (WxHxD)	36 x 90 x 58 mm
Weight	Approx. 90 g
Installation	on a 35 mm profile rail 2 module widths or wall mounting, must be mounted as the last module on the right of LOGO!
Power supply	
Input voltage	30 V DC
Permissible range	19.2 ... 28.8 V DC
Reverse polarity protection	Yes
Total current drain	I_{tot} max. 70 mA
Connections	
Digital inputs (I)	the next four inputs after the physical inputs of LOGO! ($I_n \dots I_{n+3}$)
Digital outputs (Q)	the next four outputs after the physical outputs of LOGO! ($Q_n \dots Q_{n+3}$)
I/O configuration (hex)	7
ID code (hex)	F
ID1 code (hex)	F (default, variable from 0 ... F)
ID2 code (hex)	F
Bus connection	AS interface in accordance with specification
Analog inputs (AI)	none
Analog outputs (AQ)	none
Climatic conditions	
Ambient operating conditions	0 °C ... +55 °C
Storage temperature	- 40 °C ... +70 °C
Electrical safety	
Electrical data	to AS interface specification
Degree of protection	IP 20
Interference suppression	Limit class A
Approval	
	IEC 61131-2 EN 50178 cULus to UL 508 CSA C22.2 No. 142

A.16 Technical data: LOGO!Power 12 V

LOGO! Power 12 V is a primary-switched power supply unit for LOGO! devices. Two current ranges are available.

	LOGO! Power 12 V / 1.9 A	LOGO! Power 12 V / 4.5 A
Input data		
Input voltage	100 ... 240 V AC	
Permissible range	85 ... 264 V AC	
Permissible mains frequency	47 ... 63 Hz	
Voltage failure buffering	> 40 ms (at 187 V AC)	
Input current	0.53 ... 0.3 A	1.13 ... 0.61 A
Make current (25°C)	≤15 A	≤ 30 A
Device protection	Internal	
Recommended circuit breaker (IEC 898) in mains line	≥ 16 A characteristic B ≥ 10 A characteristic C	
Output data		
Output voltage	12 V DC	
Overall tolerance	±3 %	
Adjustment range	10.5 ... 16.1 V DC	
Residual ripple	< 200/300 mV _{pp}	
Output current	1.9 A	4.5 A
Overcurrent limiting	typ. 2.5 A	typ. 5.9 A
Efficiency	typ. 80 %	typ. 85 %
Parallel circuit for power increase	Yes	
Electromagnetic compatibility		
Interference suppression	EN 50081-1, Class B to EN 55022	
Interference immunity	EN 61000-6-2, EN 61000-4-2/-3/-4/-5/-6/-11	
Safety		
Electrical isolation, primary/secondary	Yes, SELV (to EN 60950 and EN 50178)	
Safety class	II	
Degree of protection	IP 20 (to EN 60529)	
CE marking	Yes	
UL/cUL certification	Yes; UL 508 / UL 60950	
FM approval	Yes; Class I, Div. 2, T4	
GL approval	Yes	
General details		
Ambient temperature range	-20 ... +55°C, natural convection	
Storage and shipping temperature	-40 ... +70°C	
Connections at input	One terminal (1 x 2.5 mm ² or 2 x 1.5 mm ²) per L1 and N	
Connections at output	Two terminals (1x.2.5 mm ² or 2 x 1.5 mm ²) per + and -	
Installation	On 35 mm DIN rail, snap-on	
Dimensions in mm (WxHxD)	54 x 80 x 55	72 x 90 x 55
Approx. weight	0.2 kg	0.3 kg

A.17 Technical data: LOGO!Power 24 V

LOGO! Power 24 V is a primary-switched power supply module for LOGO! devices. Two current ranges are available.

	LOGO! Power 24 V / 1.3 A	LOGO! Power 24 V / 2.5 A
Input data		
Input voltage	100 ... 240 V AC	
Permissible range	85 ... 264 V AC	
Permissible mains frequency	47 ... 63 Hz	
Voltage failure buffering	40 ms (at 187 V AC)	
Input current	0.70 ... 0.35 A	1.22 ... 0.66 A
Inrush current (25°C)	< 15 A	< 30 A
Device protection	Internal	
Recommended circuit breaker (IEC 898) in mains line	≥ 16 A characteristic B ≥ 10 A characteristic C	
Output data		
Output voltage	24 V DC	
Overall tolerance	± 3 %	
Adjustment range	22.2 ... 26.4 V DC	
Residual ripple	< 200/300 mV _{pp}	
Output current	1.3 A	2.5 A
Overcurrent limiting	typ. 2.0 A	typ. 3.4 A
Efficiency	> 82 %	> 87 %
Parallel circuit for power increase	Yes	
Electromagnetic compatibility		
Interference suppression	EN 50081-1, Class B to EN 55022	
Interference immunity	EN 61000-6-2, EN 61000-4-2/-3/-4/-5/-6/-11	
Safety		
Electrical isolation, primary/secondary	Yes, SELV (to EN 60950 and EN 50178)	
Safety class	II	
Degree of protection	IP 20 (to EN 60529)	
CE marking	Yes	
UL/cUL certification	Yes; UL 508 / UL 60950	
FM approval	Yes; Class I, Div. 2, T4	
GL approval	Yes	
General details		
Ambient temperature range	-20 ... +55 °C, natural convection	
Storage and shipping temperature	-40 ... +70 °C	
Connections at input	One terminal (1 x. 2.5 mm ² or 2 x 1.5 mm ²) per L1 and N	
Connections at output	Two terminals (1x.2.5 mm ² or 2 x 1.5 mm ²) per + and -	
Installation	On 35 mm DIN rail, snap-on	
Dimensions in mm (WxHxD)	54 x 80 x 55	72 x 90 x 55
Approx. weight	0.2 kg	0.3 kg

A.18 Technical data: LOGO! Contact 24/230

LOGO! Contact 24 and LOGO! Contact 230 are switching modules for direct switching of ohmic loads up to 20 Amps and motors up to 4 kW (without noise emission, hum-free).

	LOGO! Contact 24	LOGO! Contact 230
Operating voltage	24 V DC	230 V AC; 50/60 Hz
Switching capacity		
Utilization category AC-1: Switching of ohmic loads at 55°C Operating current at 400 V Output with three-phase loads at 400 V	20 A 13 kW	
Utilization category AC-2, AC-3: Motor with slip ring induction/cage armature Operating current at 400 V Output with three-phase loads at 400 V	8.4 A 4 kW	
Short-circuit protection: Assignment type 1 Assignment type 2	25 A 10 A	
Connecting leads	Fine-wire with wire end ferrules Solid wire 2 x (0.75 to 2.5) mm ² 2 x (1 to 2.5) mm ² 1 x 4 mm ²	
Dimensions (WxHxD)	36 x 72 x 55	
Ambient temperature	-25 ... +55 °C	
Storage temperature	-50 ... +80 °C	

A.19 Technical data: LOGO! TD (Text Display)

LOGO! TD	
Mechanical data	
Dimensions (WxHxD)	128.2 x 86 x 38.7 mm
Weight	Approx. 220 g
Installation	Bracket mounting
Keyboard	Membrane keypad with 10 keys
Display	FSTN-Graphic Display with 128 x 64 (columns x rows), LED backlight
Power supply	
Input voltage	24 V AC/DC 12 V DC
Permissible range	20.4 ... 26.4 V AC 10.2 ... 28.8 V DC
Permissible mains frequency	47 ... 63 Hz
Power consumption	<ul style="list-style-type: none"> • 12 V DC • 24 V DC • 24 V AC
	<ul style="list-style-type: none"> • typ. 65 mA • typ. 40 mA • typ. 90 mA
Data transmission rate	19,200 baud
LCD Display and Backlight	
Backlight lifetime ¹⁾	20,000 hours
Display lifetime ²⁾	50,000 hours
Mounting hole dimensions	
Width x Height	(119.5+0.5mm) x (78.5+0.5mm)

¹⁾ Backlight lifetime is defined as: The final brightness is 50% of the original brightness.

²⁾ Display lifetime is calculated under ordinary operating and storage conditions: room temperature (20 ±8° C), normal humidity below 65% relative humidity, and not in exposure to direct sunlight.

A.20 Technical data: Battery information for LOGO! cards

Battery information for LOGO! Battery cards	
Manufacturer	Panasonic
Type	BR1220/1VCE
Voltage	3V
Capacity	35mAh
Mechanical data	
Dimensions	12.5mm x 1.6mm
Weight	0.9g

Determining the cycle time

The program cycle is the complete execution of the circuit program, that is, primarily the reading in of the inputs, the processing of the circuit program and the subsequent reading out of the outputs. The cycle time is the time required to execute a circuit program once in full.

The time required for a program cycle can be determined using a short test program. This test program is created in LOGO! and returns a value during its execution in parameter assignment mode from which the current cycle time is derived.

Test program

1. Create the test program by linking an output to a threshold trigger and connecting the trigger input with an inverted flag.

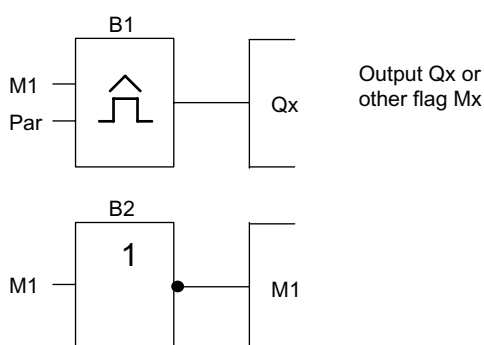

2. Configure the threshold trigger as shown below. A pulse is generated in each program cycle due to the inverted flag. The trigger interval is set to 2 seconds.

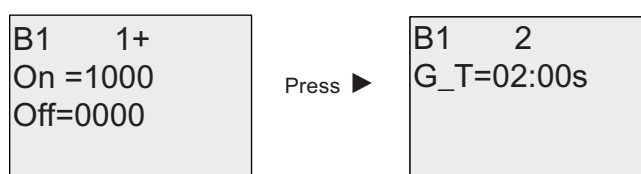

3. Now start the circuit program and switch LOGO! to parameter assignment mode. In this mode, view the trigger parameters.

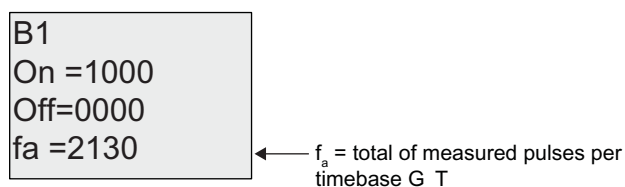

4. The reciprocal value of f_a is equivalent to the LOGO! execution time of the current circuit program in its memory.

$$1/f_a = \text{cycle time in s}$$

Explanation

The inverted flag block changes its output signal at each program execution. Thus, one logic level (high or low) width is exactly equivalent to the length of one cycle. Hence, a period lasts 2 cycles.

The threshold trigger indicates the ratio of periods per 2 seconds, which results in the ratio of cycles per second.

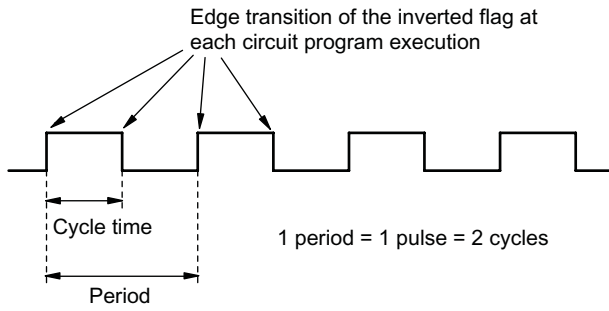

LOGO! without display

Because some specific applications do not require operator control and monitoring units such as buttons or a display, we provide the LOGO! 12/24RCo, LOGO! 24o, LOGO! 24RCo and LOGO! 230RCo versions without display.

View of a LOGO! 230RCo, for example:

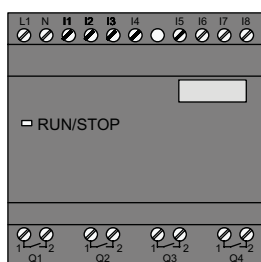

Less is definitely more!

The versions without display offer you the following benefits:

- Even more cost-effective without the operating element
- Requires less switch cabinet space than conventional hardware
- Substantial benefits with regard to flexibility and prime costs compared to stand-alone electronic switchgear
- Of advantage even for applications in which merely two or three conventional switching devices can be replaced
- Very easy to use
- Access protected
- Compatible to LOGO! versions with display
- Offers the option to read data by means of LOGO!Soft Comfort

Creating a circuit program without operator panel

There are two ways to create a circuit program for a LOGO! without display:

- You create the circuit program with LOGO!Soft Comfort on your PC and then download it to LOGO!.
- You download the circuit program from a LOGO! memory card or combined memory/battery card (Page 223) to your LOGO! without display.

Operating characteristics

LOGO! is ready for operation when power is switched on. Switching off a LOGO! without display is equivalent to disconnecting the power supply, e.g. as if you were removing the plug.

The circuit program of LOGO!...o versions cannot be started or stopped by means of buttons. This is why the LOGO!...o versions have other startup characteristics:

Startup characteristics

If there is no circuit program in LOGO! or on the inserted memory card or combined memory/battery card, LOGO! remains in STOP.

If there is a valid circuit program in LOGO! memory, the LOGO! automatically switches from STOP to RUN when power is switched on.

The circuit program on an inserted memory card or combined memory/battery card is automatically copied to LOGO!, immediately after power is switched on. The existing circuit program in LOGO! memory is overwritten. The system automatically changes from STOP to RUN.

Provided the PC cable is connected to LOGO! (Page 235), you can download the circuit program to LOGO! and start it by means of LOGO!Soft Comfort PC software.

Operating status indication

Operating states, e.g. Power On, RUN and STOP are indicated by an LED on the front hood.

- Red LED: Power On/STOP
- Green LED: Power On/RUN

The red LED is lit after Power On and in all LOGO! states other than RUN. The green LED is lit when LOGO! is in RUN mode.

Reading current data

LOGO!Soft Comfort provides an online test for reading the current data of all functions while the system is in RUN.

If your LOGO! without display holds a protected memory card or combined memory/battery card, you cannot read the current data unless you enter the correct password (Page 225) for the circuit program. The circuit program is otherwise deleted from LOGO! memory when you remove the memory card or combined memory/battery card to connect the PC cable.

Deleting the circuit program

Use LOGO!Soft Comfort to delete the circuit program and password if a password exists.

LOGO! menu structure

D.1 LOGO! Basic Module

Menu overview

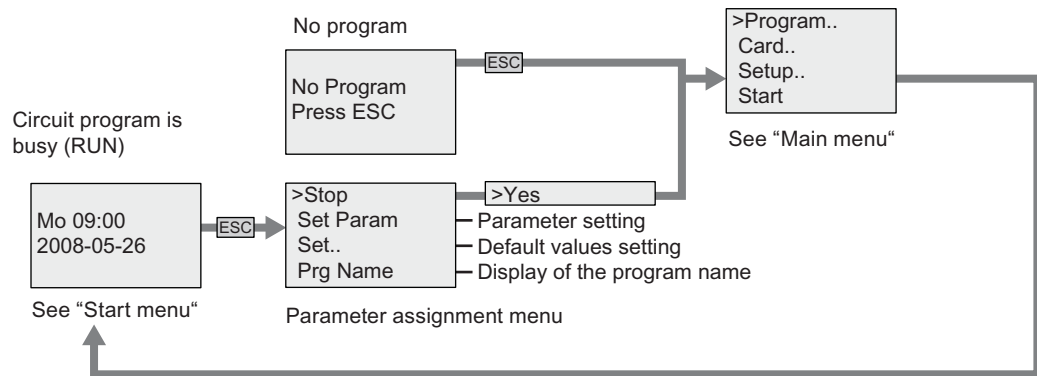

Main menu (ESC / > Stop)

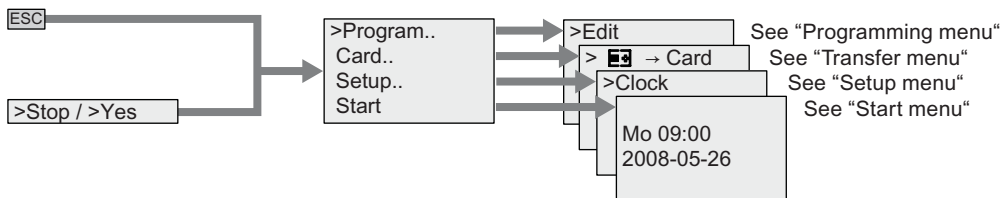

Programming menu (ESC / > Stop → > Program)

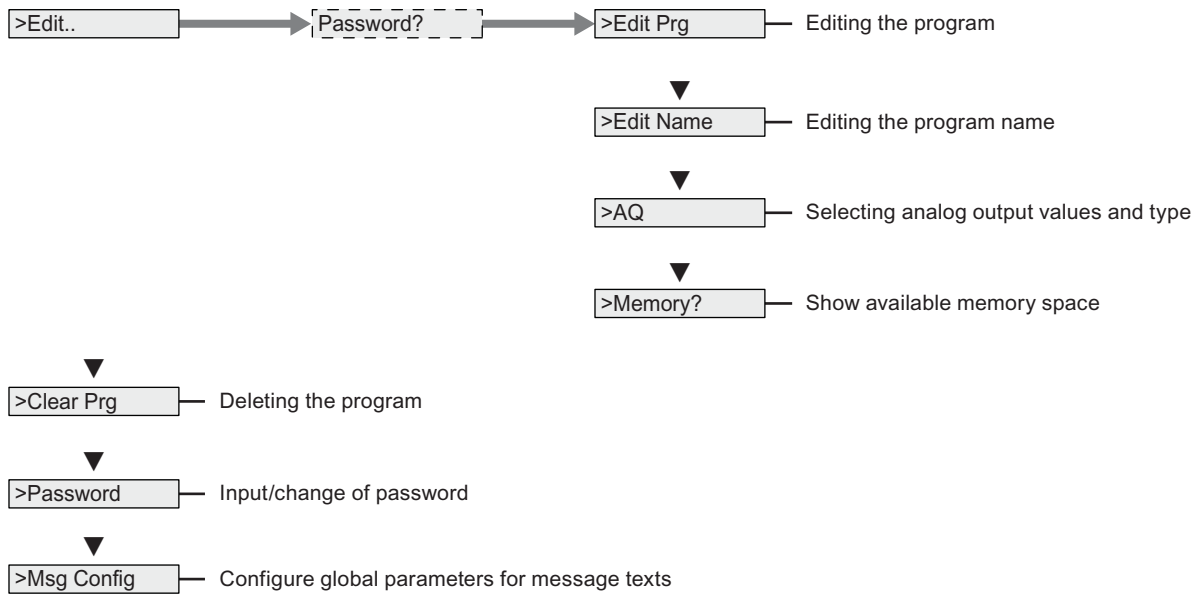

Transfer menu (ESC / > Stop → > Card)

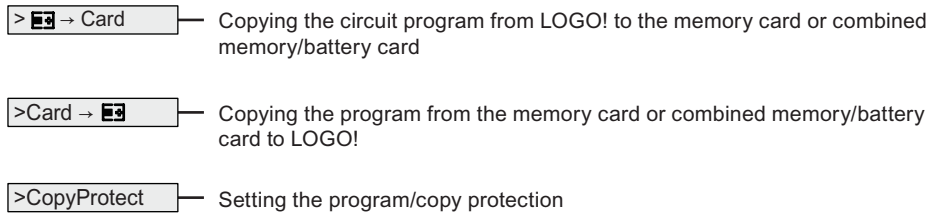

Setup menu (ESC / > Stop → > Setup)

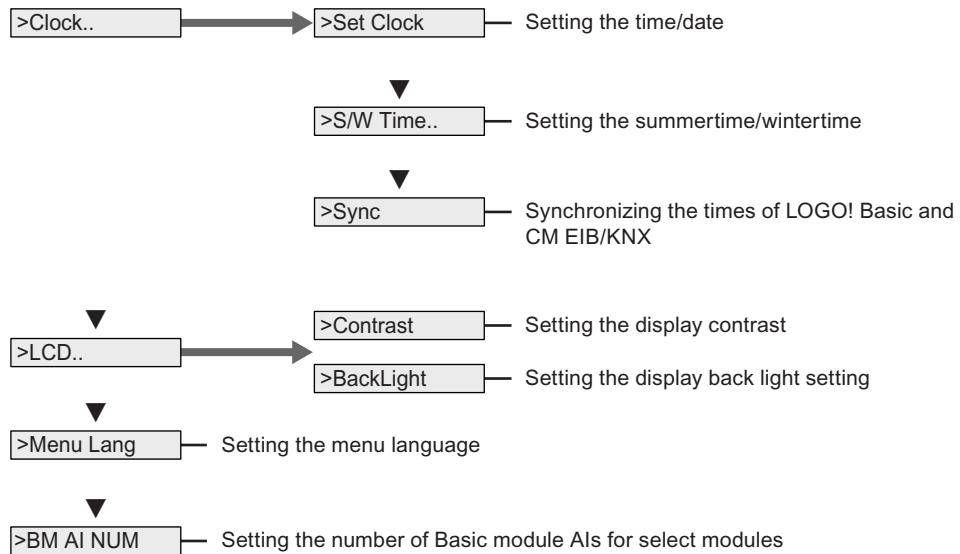

Start Menu (RUN)

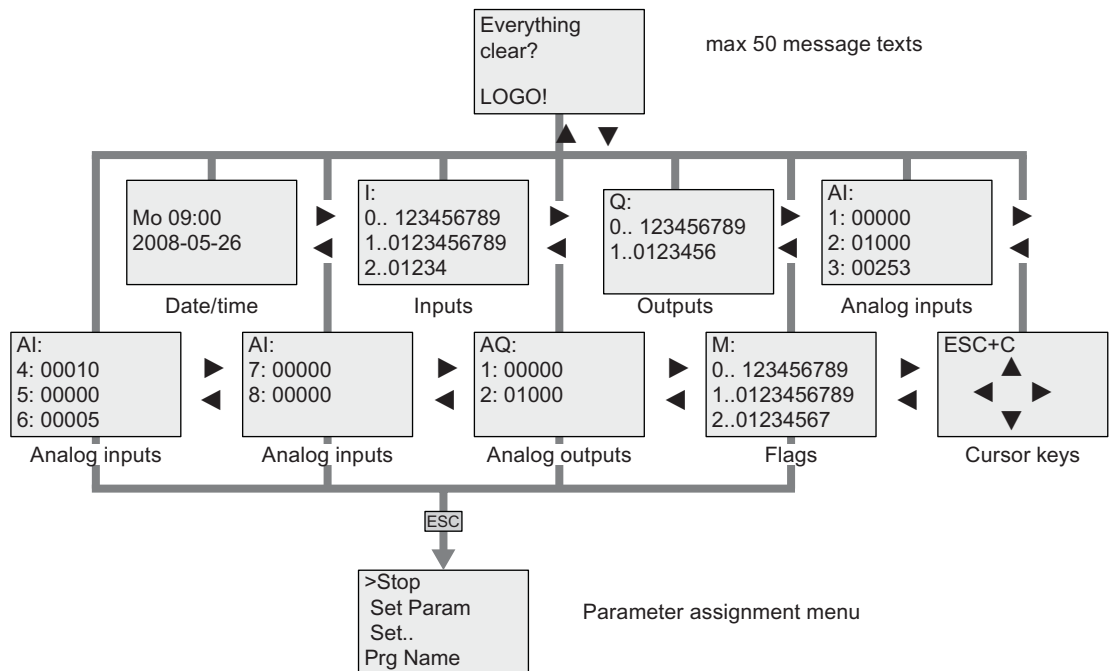

See also

Parameters (Page 213)
Assigning a circuit program name (Page 73)
Selecting analog output values for RUN/STOP transition (Page 89)
Defining the type of analog outputs (Page 90)
Memory space and circuit program size (Page 97)
Deleting the circuit program and password (Page 91)
Password (Page 74)
Message texts (Page 175)
Setting the default values for LOGO! (Page 217)
Writing and starting the circuit program (Page 66)
Copying data from LOGO! to the memory card (Page 229)
Copying data from the memory card to LOGO! (Page 230)
Security function (CopyProtect) (Page 225)
Summertime/wintertime conversion (Page 92)
Synchronization (Page 96)
Setting the time of day and date (LOGO! ... C) (Page 218)
Setting the display contrast and backlight choice (Page 219)
Setting the number of AIs in the Basic Module (Page 221)
Setting the menu language (Page 220)

D.2 LOGO! TD

Menu overview

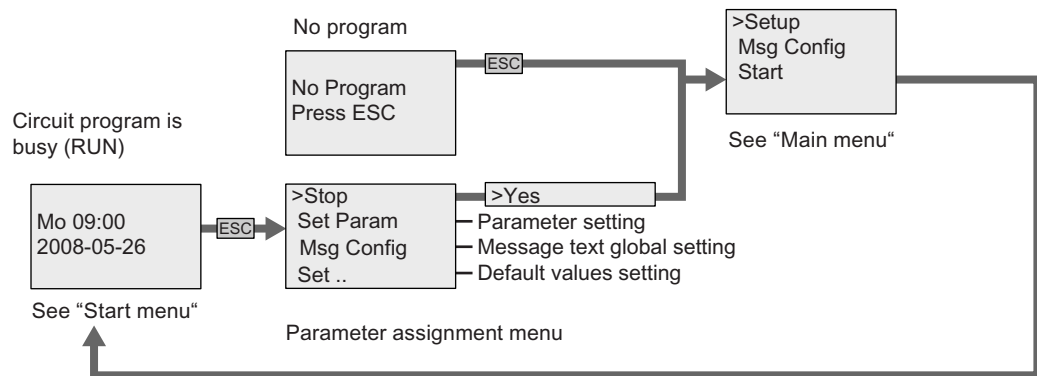

Main menu (ESC / > Stop)

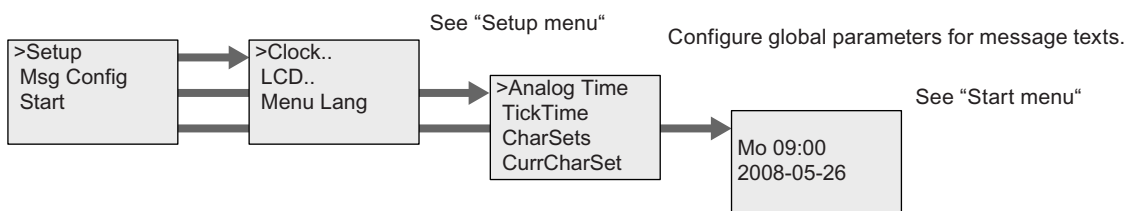

Setup menu (ESC / > Stop → >Setup)

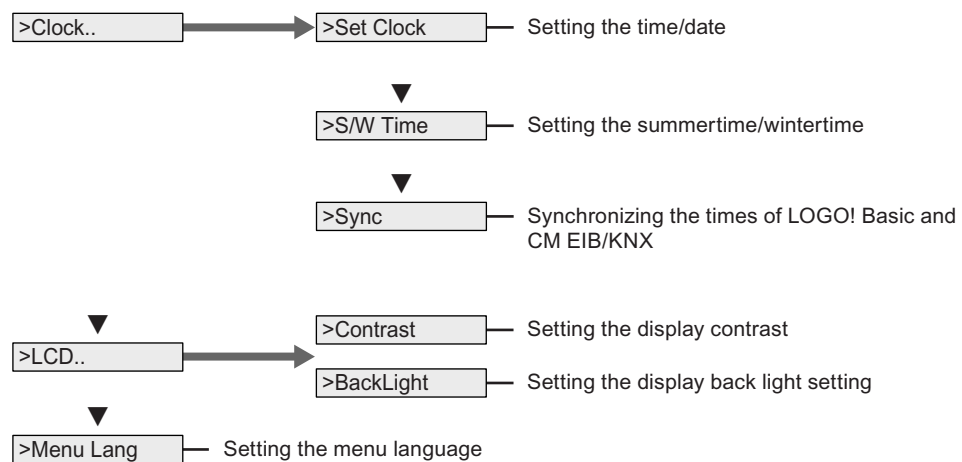

Start menu (Basic module in RUN)

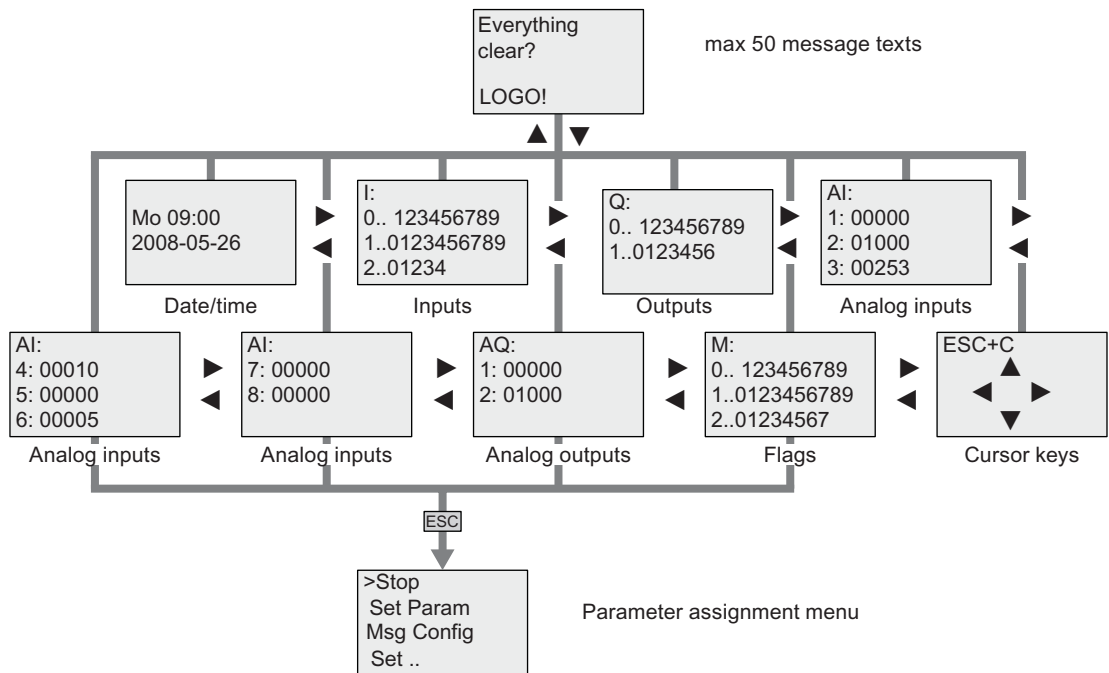

See also

- Parameters (Page 213)
- Setting the default values for LOGO! (Page 217)
- Message texts (Page 175)
- Setting the time of day and date (LOGO! ... C) (Page 218)
- Summertime/wintertime conversion (Page 92)
- Synchronization (Page 96)
- Setting the display contrast and backlight choice (Page 219)
- Setting the menu language (Page 220)

Order numbers

Modules

Variant	Designation	Order number
Basic	LOGO! 12/24 RC *	6ED1052-1MD00-0BA6
	LOGO! 24 *	6ED1052-1CC00-0BA6
	LOGO! 24 RC (AC/DC)	6ED1052-1HB00-0BA6
	LOGO! 230 RC (AC/DC)	6ED1052-1FB00-0BA6
Basic without display (pure)	LOGO! 12/24 RCo *	6ED1052-2MD00-0BA6
	LOGO! 24o *	6ED1052-2CC00-0BA6
	LOGO! 24 RCo (AC/DC)	6ED1052-2HB00-0BA6
	LOGO! 230 RCo (AC/DC)	6ED1052-2FB00-0BA6
Digital modules	LOGO! DM 8 12/24R	6ED1055-1MB00-0BA1
	LOGO! DM 8 24	6ED1055-1CB00-0BA0
	LOGO! DM 8 24R	6ED1055-1HB00-0BA0
	LOGO! DM 8 230R	6ED1055-1FB00-0BA1
	LOGO! DM 16 24	6ED1055-1CB10-0BA0
	LOGO! DM 16 24R	6ED1055-1NB10-0BA0
	LOGO! DM 16 230R	6ED1055-1FB10-0BA0
Analog modules	LOGO! AM 2	6ED1055-1MA00-0BA0
	LOGO! AM 2 PT100	6ED1055-1MD00-0BA0
	LOGO! AM 2 AQ (0...10V)	6ED1055-1MM00-0BA0
	LOGO! AM 2 AQ (0...10V, 0/4...20mA)	6ED1055-1MM00-0BA1
Communication modules	CM EIB/KNX	6BK1700-0BA00-0AA1
	CM AS Interface	3RK1400-0CE10-0AA2
Text Display module	LOGO! TD	6ED1055-4MH00-0BA0

*: Also with analog inputs

Accessories

Accessories	Designation	Order number
Software	LOGO!Soft Comfort V6.1	6ED1058-0BA02-0YA0
	Upgrade to LOGO!Soft Comfort V6.1	6ED1058-0CA02-0YE0
Memory card	LOGO! Memory Card	6ED1056-1DA00-0BA0
Battery card	LOGO! Battery card	6ED1 056-6XA00-0BA0
Combined memory/battery card	LOGO! Combined Memory/Battery Card	6ED1 056-7DA00-0BA0
Switching modules	LOGO!Contact 24 V	6ED1057-4CA00-0AA0
	LOGO!Contact 230 V	6ED1057-4EA00-0AA0
Power modules	LOGO!Power 12V/1.9A	6EP1321-1SH02
	LOGO!Power 12V/4.5A	6EP1322-1SH02
	LOGO!Power 24V/1.3A	6EP1331-1SH02
	LOGO!Power 24V/2.5A	6EP1332-1SH42
	LOGO!Power 24V/4A	6EP1332-1SH51
	LOGO!Power 5V/3A	6EP1311-1SH02
	LOGO!Power 5V/6.3A	6EP1311-1SH12
	LOGO!Power 15V/1.9A	6EP1351-1SH02
	LOGO!Power 15V/4A	6EP1352-1SH02
Others	PC cable	6ED1057-1AA00-0BA0
	USB PC cable	6ED1057-1AA01-0BA0
	Modem cable	6ED1057-1CA00-0BA0
	Manual	6ED1050-1AA00-0BE7

Abbreviations

AM	Analog module
B1	Block number B1
BN	Block Number
C	LOGO! Device designation: integrated clock
CM	Communication Module
Cnt	Count = Counter input
Co	Connector
Dir	Direction (of count, for example)
DM	Digital Module
EIB	European Installation Bus
EIS	EIB Interoperability Standard
En	Enable = switching on (e.g., clock generators)
ETS	EIB Tool Software
Fre	Input for frequency signals to be analyzed
GF	Basic Functions
Inv	Input for inverting the output signal
KNX	Konnex Association Standard for home and building electronic systems
No	Cam (parameter of the timer)
o	In LOGO! designations: without display
Par	Parameter
R	Reset input
R	In LOGO! designations: Relay outputs
Ral	Reset all = Input for resetting all internal values
S	Set (latching relay, for example)
SF	Special functions
SU	Subunit
T	Time = parameter
TD	Text Display
Trg	Trigger (parameter)
0BA6 device	The latest LOGO! Basic version, described in this manual

Index

A

- AM See Analog module, 10
- Amplifier
 - analog, 170
- Analog
 - comparator, 163
 - values, 115
- Analog amplifier, 170
- Analog differential trigger, 160
- Analog math, 204
- Analog math error detection, 207
- Analog module, 10
- Analog multiplexer, 190
- Analog ramp, 192
- Analog threshold trigger, 157
- Analog value monitoring, 167
- Analog watchdog, 167
- AND, 106
- AS interface, 10
- AS interface bus
 - communication failure, 52
 - communication states, 52
- Asynchronous pulse generator, 130

B

- Backlight flags, 103
- Backlight lifetime
 - LOGO! TD, 265
- Basic functions, 101, 105
 - AND, 106
 - AND, with edge, 107
 - NAND, 108
 - NAND, with edge, 108
 - NOT, 111
 - OR, 109
 - XOR, 111
- Basics on special functions, 112
- blank outputs, 102
- BN, 101

C

- Cap, 30
- Card See Program module (card), 223
- CE label, 20
- Ch by Ch ticking, 180
- Character set flag, 103
- Character sets, 175
- Chinese character set, 176
- circuit program, 97
- Circuit programs
 - archiving, 223
 - reproduce, 223
 - send by mail, 223
- CM See Communications module, 10
- Co, 101, 102
- Combined memory/battery card, 223
- Communication module
 - AS interface, 10
 - EIB/KNX, 10
- Communication modules, 10
- Compatibility
 - Expansion modules, 29
- Connector, 30
- Connectors, 101, 102
 - hi, 55
 - inputs, 55
 - lo, 55
 - open, 104
 - outputs, 55
 - unused, 55, 61
 - x, 55, 61, 112
- Constants, 102
- Conversion
 - Summertime and wintertime, 92
- Counters
 - Operating hours, 150
 - Threshold trigger, 154
 - Up/down, 147
- cULus, 20
- Cursor keys, 104, 185

D

- Days of the week, 139
- Demo versions, 234
- Detection of math error
 - Analog amplifier, 207
- Digital module, 10
- DIN rail, 29
- Display lifetime
 - LOGO! TD, 265
- Display modules, 10
- Divide by 0 error, 207
- DM8... See Digital module, 10

E

- Edge evaluation, 107, 108
- EIB bus
 - communication failure, 52
 - communication states, 52
- EIB/KNX, 10
- Errors, analog math, 207
- exclusive OR, 111
- Expansion modules, 10, 54
 - Analog, 10
 - digital, 10
 - operating state, 51

F

- Flag blocks, 103
- FM, 20
- Frequency trigger, 154
- Function keys, 10

G

- Gain, 115
- GB-2312, 175
- GF, 101, 105

H

- high-speed counting, 39
- Hours counter, 150
 - Reading the MN and OT values, 152
- Hysteresis, 166

I

- inputs
 - High-speed inputs, 39
- Inputs, 102
 - Analog inputs, 39, 102
 - Cursor keys, 104
 - Digital Inputs, 102
 - inverting, 105, 117
- Instructions
 - Basic functions (GF), 101
 - Co, 102
 - Connectors (Co), 101
 - GF, 105
 - SF, 117
 - Special Functions (SF), 101
- Interlock, 31
- Internet address, 4
- Inverter, 111
- ISO8859-1, 175
- ISO8859-16, 175
- ISO8859-5, 175
- ISO8859-9, 175

L

- Latching relay, 172
- LCD lifetime
 - LOGO! TD, 265
- LED, 270
- Levels, 104
- Ln by Ln ticking, 181
- Logical inputs, 112
- LOGO! TD, 10
 - function keys, 10
 - power-up screen, 10
- LOGO! TD
 - Backlight lifetime, 265
- LOGO! TD
 - Display lifetime, 265

M

Math error
 analog, 207
 Memory
 limitation, 97
 Memory card, 223
 Card → LOGO, 231
 CopyProtect, 226
 LOGO → Card, 229
 Memory/battery card, 223
 Message text charset flag, 103
 Message texts, 175
 character set, 175
 Message ticking, 180
 Mode
 PC-LOGO, 235
 Modems, 4
 Multiple function switch, 136

N

NAND, 108
 Negation, 111
 of an input, 105
 of an SF input, 117
 NOT, 111

O

Offset, 115
 Off-time, 139
 On-/Off- delay, 124
 On-delay, 120
 On-delay, retentive, 126
 On-time, 139
 Open connectors, 104
 OR, 109
 Outputs, 102
 Analog outputs, 102
 blank, 102
 Digital outputs, 102
 Overflow error, 207

P

Parameter
 Inputs, 113
 Set Param, 212
 setting, 211
 T, 113
 Parameter assignment menu, 212
 Parameter assignment screen form, 139, 179
 Parameter protection, 114
 PC-LOGO, 235
 PI controller, 196
 Program cycle, 267
 Program memory, 97
 Program name
 change, 73
 character set, 73
 read, 213
 Programming menu
 AQ in Stop, 89
 AQ type, 90
 Clear Prg, 91
 Edit Name, 73
 Edit Prg, 66
 Password, 75
 Pulse
 Pause, 129
 width, 129
 Pulse generator
 Asynchronous, 130
 Pulse output, 127
 Pulse relay, 173
 Pulse Width Modulator (PWM), 201
 PWM, 201

R

Random generator, 132
 Relay outputs, 255
 service life, 255
 switching capacity, 255
 Removal, 31
 Retentive memory, 97
 Retentive on-delay, 126
 Retentivity, 114

S

- Sensor connections, 40
- Set clock, 218
- Setting the date, 217
- Settings, 213
- Setup
 - with different voltage classes, 27
- SF, 101, 112, 117
- Shift register, 188
- Shift register bits, 104
- Shift-JIS, 175
- Signal status transitions, 38
- Simulation, 233
- Softkey, 186
- Software, 233
- Special functions, 101, 117
 - Analog amplifier, 170
 - Analog comparator, 163
 - Analog differential trigger, 160
 - Analog math, 204
 - Analog math error detection, 207
 - Analog multiplexer, 190
 - Analog ramp, 192
 - Analog threshold trigger, 157
 - Analog value monitoring, 167
 - Analog watchdog, 167
 - Asynchronous pulse generator, 130
 - Basics, 112
 - Edge-triggered wiping relay, 128
 - Hours counter, 150
 - Latching relay, 172
 - Message texts, 175
 - Multiple function switch, 136
 - Off-delay, 123
 - On-/Off- delay, 124
 - On-delay, 120
 - PI controller, 196
 - Pulse output, 127
 - Pulse relay, 173
 - Pulse Width Modulator (PWM), 201
 - Random generator, 132
 - Relays, 127, 128, 172, 173
 - Retentive on-delay, 126
 - Shift register, 188
 - Softkey, 186
 - Stairway lighting switch, 133
 - Threshold trigger, 154
 - Triggers, 157, 160
 - Up-down counter, 147
 - Weekly timer, 138
 - Wiping relay, 127
 - Yearly timer, 142

- Stairway lighting switch, 133
- Start, 79
- Startup flag, 103
- Stop, 212
- Subunits, 29
- Summertime, 92
- Summertime/wintertime conversion, 217
 - Clock, 92
 - S/W Time, 92
- Switch
 - Multiple function, 136
 - Stairway lighting, 133
- Switched current
 - maximum, 43
- Synchronization, 217
 - Clock, 96
 - Sync, 96

T

- Text Display (TD), 10
- Threshold trigger, 154
- Ticker, 180
- Time response, 113
- Timebase, 113, 120
- Timer
 - accuracy, 113
- Timers
 - Asynchronous pulse generator, 130
 - Edge-triggered wiping relay, 128
 - Multiple function switch, 136
 - Off-delay, 123
 - On-/Off- delay, 124
 - On-delay, 120
 - Random generator, 132
 - Retentive on-delay, 126
 - Stairway lighting switch, 133
 - Weekly, 138
 - Wiping relay (pulse output), 127
 - Yearly, 142
- Timing inaccuracy, 113
- Trigger
 - Analog differential, 160
 - Analog threshold, 157

U

- Underflow error, 207
- Unused connectors, 55, 61
- Up/down counter, 147
- URL, 4

V

- Voltage levels, 104
- Voltage supply
 - Circuit protection, 35

W

- Weekly timer, 16, 138, 140
 - Examples, 141
 - setting, 140
- Wintertime, 92
- Wiping relay
 - edge triggered, 128
- Wire ferrules, 34
- without display
 - PC-LOGO mode, 235

X

- XOR, 111

Y

- Yearly timer, 142

Z

- Zero division error, 207
- Zero offset, 115

