

THE COMPLETE ROOF SYSTEM SELECTOR



ROOF / BRICK / PAVER / FACADE / BLOCK

INTRODUCTION

Founded in 19th Century Vienna, Wienerberger is a leading provider of wall, roof and landscaping innovations. Today, we have 217 production sites in 27 countries. In the UK, Wienerberger has three showrooms, thirteen production sites and eight distribution depots, with our head office in Cheadle, Cheshire.

With in excess of 1000 products across wall, roof and landscaping categories, we offer building solutions across the whole envelope. From the latest in construction innovation to traditional handmade and heritage techniques, we're able to provide our customers with a whole suite of added value systems and services.

As a company, we believe that everything we do should make a lasting contribution towards creating a better quality of life.

In the UK, we offer one of the broadest product portfolios in the construction business, including clay facing bricks (stock and wire-cut), specialist engineering bricks, the Porotherm clay block system, façade solutions including SVK fibre cement panels, the Corium cladding system and a wide range of brick slips. We also offer a full range of Sandtoft and Koramic clay and concrete roofing products, Keymer handmade roof tiles, bespoke heritage products and a range of domestic and commercial pavers.

CONTENTS

Roof Tile Selector	4	Concrete & Clay Ridge	88-89
Colour Range	6-11	Concrete Ridge	90-91
Concrete	7	Concrete Decorative Ridge	92-93
Clay	8-9	Clay Ridge	94-95
Keymer	10-11	Duracoat® Ridge	96-97
Concrete Tiles	12-33	Clay / Duracoat® Decorative Ridge	98-99
Plain Tile	14-15	Roofing Systems	100-137
Lindum	16-17	Underlays	102
Standard Pattern	18-19	TLE / Medium Format Dry Verge	103
Shire Pantile	20-21	Multiverge	104
Calderdale Edge	22-23	Roll Ridge	105
Dual Calderdale Edge	24-25	Roll Hip	106
TLE	26-27	Multiversal Ridge and Hip	107
Dual TLE	28-29	Profile Ridge	108
Double Roman	30-31	Profile Mono Ridge	109
Double Pantile	32-33	In-Line Tile Ventilators	110
Clay Tiles	34-79	Cowl Ventilators	111
Humber Plain Tile	36-37	Plain Tile InvisiVent	112
Humber Plain Tile Sanded	38-39	Eaves Ventilation System	113
Village Plain Tile	40-41	Top Abutment Ventilator	114
Alban Plain Tile	42-43	Lead Replacement	115
Barrow Plain Tile	44-45	Mortarless Bonding Gutter	116
301 Plain Tile	46-47	Universal Dry Valley	117
303 Plain Tile	48-49	Accessories	118-123
20/20	50-51	In-roof Solar	124-133
Vauban	52-53		
Cassius	54-55		
Rivius	56-57		
Actua	58-59		
Neo Plus	60-61		
New County Pantile	62-63		
Old English Pantile	64-65		
Arcadia Pantile	66-67		
451 Old Hollow Pantile	68-69		
Olympus Double Pantile	70-71		
Modula	72-73		
Bridgwater	74-75		
Gaelic Single Roman	76-77		
Tempest 44 Single Roman	78-79		
Keymer	80-81		
Goxhill Plain Tile	82-83		
Shire Plain Tile	84		
Traditional Plain Tile	85		
Peg Tile	86		
Fittings	87		

Need to download our tiles as BIM objects?
Simply click the BIM object button
on the corresponding tile page.

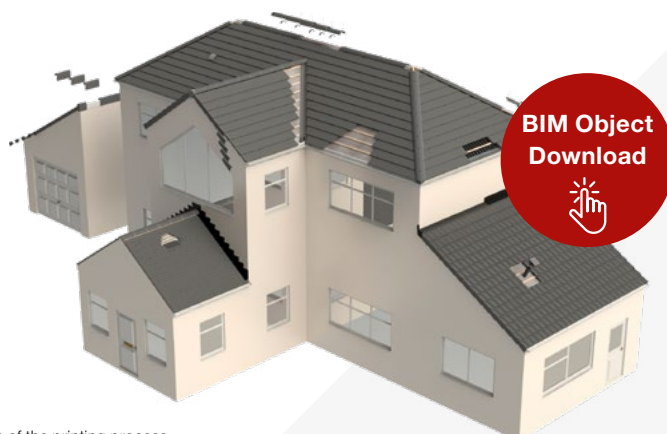

© Wienerberger Ltd 07/23. All rights reserved. N.B. Due to the limitations of the printing process and screen calibration settings when viewing the online version, you are advised to obtain product samples prior to purchase. All information contained in this book is believed to be correct at the time of going to press. Wienerberger reserve the right to add, delete or alter products without notice and recommend you contact us to obtain the latest information.

ROOF TILE SELECTOR



Plain Tile

Plain Tile



Material Concrete
Minimum roof pitch 35°
Size of tile (mm) 265 x 165
Quantity per pallet 768
Covering capacity (per m²) * 60.0 tiles
Full product details on page 14-15

Goxhill Plain Tile



Material Clay
Minimum roof pitch 35°
Size of tile (mm) 265 x 165
Quantity per pallet 540
Covering capacity (per m²) * 60.0 tiles
Full product details on page 82-83

Large Format Flat Tile

Calderdale Edge



Material Concrete
Minimum roof pitch ² 16.5° - 22.5°[†]
Size of tile (mm) 420 x 334
Quantity per pallet 192
Covering capacity (per m²) 10.2 - 9.5 tiles
Full product details on page 22-23

Humber Plain Tile (also available in Sanded) ²



Material Clay
Minimum roof pitch 35°
Size of tile (mm) 265 x 165
Quantity per pallet 540
Covering capacity (per m²) * 60.0 tiles
Full product details on page 36-39

Shire Plain Tile



Material Clay
Minimum roof pitch 40°
Size of tile (mm) 265 x 165
Quantity per pallet 550
Covering capacity (per m²) * 60.0 tiles
Full product details on page 84

Dual Calderdale Edge



Material Concrete
Minimum roof pitch ² 16.5° - 22.5°[†]
Size of tile (mm) 420 x 334
Quantity per pallet 192
Covering capacity (per m²) 10.2-9.5 tiles
Full product details on page 24-25

Village Plain Tile



Material Clay
Minimum roof pitch 35°
Size of tile (mm) 265 x 165
Quantity per pallet 540
Covering capacity (per m²) * 60.0 tiles
Full product details on page 40-41

Traditional Plain Tile



Material Clay
Minimum roof pitch 40°
Size of tile (mm) 265 x 165
Quantity per pallet 760
Covering capacity (per m²) * 60.0 tiles
Full product details on page 85

TLE



Material Concrete
Minimum roof pitch ² 17.5° - 22.5°[†]
Size of tile (mm) 420 x 334
Quantity per pallet 240
Covering capacity (per m²) 10.3 - 9.6 tiles
Full product details on page 26-27

Alban Plain Tile



Material Clay
Minimum roof pitch 35°
Size of tile (mm) 265 x 165
Quantity per pallet 530
Covering capacity (per m²) * 60.0 tiles
Full product details on page 42-43

Peg Tile



Material Clay
Minimum roof pitch 40°
Size of tile (mm) 250 x 150
Quantity per pallet 800
Covering capacity (per m²) * 70.0 tiles
Full product details on page 86

Dual TLE



Material Concrete
Minimum roof pitch ² 17.5° - 22.5°[†]
Size of tile (mm) 420 x 334
Quantity per pallet 240
Covering capacity (per m²) 10.3 - 9.6 tiles
Full product details on page 28-29

Barrow Plain Tile



Material Clay
Minimum roof pitch 35°
Size of tile (mm) 265 x 165
Quantity per pallet 530
Covering capacity (per m²) * 60.0 tiles
Full product details on page 44-45

Medium Format Plain Tile

20/20



Material Clay
Minimum roof pitch 15° - 22.5°[†]
Size of tile (mm) 330 x 226
Quantity per pallet 480
Covering capacity (per m²) 22.7 - 20.5 tiles
Full product details on page 50-51

Cassius



Material Clay
Minimum roof pitch 22.5°
Size of slate (mm) 418 x 335
Quantity per pallet 240
Covering capacity (per m²) * 9.5 tiles
Full product details on page 54-55

301 Plain Tile



Material Clay
Minimum roof pitch 35°
Size of tile (mm) 270 x 170
Quantity per pallet 1152
Covering capacity (per m²) * 57.4 tiles
Full product details on page 46-47

Rivius



Material Clay
Minimum roof pitch 22.5°
Size of slate (mm) 418 x 335
Quantity per pallet 240
Covering capacity (per m²) * 9.5 tiles
Full product details on page 56-57

303 Plain Tile



Material Clay
Minimum roof pitch 35°
Size of tile (mm) 270 x 170
Quantity per pallet 1152
Covering capacity (per m²) * 57.4 tiles
Full product details on page 48-49

Vauban



Material Clay
Minimum roof pitch 22.5°
Size of tile (mm) 366 x 202
Quantity per pallet 350
Covering capacity (per m²) * 21.8 tiles
Full product details on page 52-53

Actua



Material Clay
Minimum roof pitch 22.5°
Size of tile (mm) 472 x 303
Quantity per pallet 240
Covering capacity (per m²) * 10.4 tiles
Full product details on page 58-59

Key

- Concrete tile. * Covering capacity at maximum gauge (per m²).
- Clay tile. † Refer to the Low Pitch Installation Guide, available on our website.
- Keymer tile. ¹ Minimum pitches for concrete tiles are for Smooth colours only - for Sanded colours minimum pitch is 30°.
- ✦ Handmade tile. ² For Calderdale Edge, Dual Calderdale Edge, TLE, Dual TLE, Double Pantile, Double Roman, 20/20, Neo Plus and Modula minimum pitch is subject to headlap.

This data is correct at the time of going to press and may be subject to change.

Pantiles

Shire Pantile (also available in Sanded)²



Material	Concrete
Minimum roof pitch ¹	17.5°
Size of tile (mm)	380 x 230
Quantity per pallet	360
Covering capacity (per m ²) * 16.4 tiles	
Full product details on page 20-21	

Double Pantile (also available in Sanded)²



Material	Concrete
Minimum roof pitch ^{1,2}	15° - 22.5° [†]
Size of tile (mm)	420 x 334
Quantity per pallet	210
Covering capacity (per m ²) 10.5 - 9.7 tiles	
Full product details on page 32-33	

Neo Plus



Material	Clay
Minimum roof pitch ²	20° [†]
Size of tile (mm)	384 x 250
Quantity per pallet	432
Covering capacity (per m ²) * 14.9 tiles	
Full product details on page 60-61	

New County Pantile



Material	Clay
Minimum roof pitch	22.5°
Size of tile (mm)	382 x 256
Quantity per pallet	378
Covering capacity (per m ²) * 15.5 tiles	
Full product details on page 62-63	

Old English Pantile



Material	Clay
Minimum roof pitch	30°
Size of tile (mm)	342 x 252
Quantity per pallet	288
Covering capacity (per m ²) * 17.3 tiles	
Full product details on page 64-65	

Arcadia Pantile



Material	Clay
Minimum roof pitch	30°
Size of tile (mm)	342 x 252
Quantity per pallet	288
Covering capacity (per m ²) * 17.3 tiles	
Full product details on page 66-67	

451 Old Hollow Pantile



Material	Clay
Minimum roof pitch	25°
Size of tile (mm)	355 x 246
Quantity per pallet	432
Covering capacity (per m ²) * 18.9 tiles	
Full product details on page 68-69	

Olympus Double Pantile



Material	Clay
Minimum roof pitch	22.5°
Size of tile (mm)	408 x 327
Quantity per pallet	210
Covering capacity (per m ²) * 10.2 tiles	
Full product details on page 70-71	

Roman Tiles

Double Roman



Material	Clay
Minimum roof pitch ²	17.5° - 22.5° [†]
Size of tile (mm)	445 x 330
Quantity per pallet	240
Covering capacity (per m ²) 10.4 - 9.7 tiles	
Full product details on page 30-31	

Modula



Material	Clay
Minimum roof pitch ²	17.5° - 22.5° [†]
Size of tile (mm)	342 x 255
Quantity per pallet	260
Covering capacity (per m ²) 9.7 - 9.1 tiles	
Full product details on page 72-73	

Bridgwater



Material	Clay
Minimum roof pitch	30°
Size of tile (mm)	420 x 340
Quantity per pallet	186
Covering capacity (per m ²) * 9.6 tiles	
Full product details on page 74-75	

Gaelic Single Roman



Material	Clay
Minimum roof pitch	30°
Size of tile (mm)	342 x 255
Quantity per pallet	260
Covering capacity (per m ²) * 17.0 tiles	
Full product details on page 76-77	

Tempest 44 Single Roman



Material	Clay
Minimum roof pitch	22° [†]
Size of tile (mm)	302 x 221
Quantity per pallet	660
Covering capacity (per m ²) * 20.7 tiles	
Full product details on page 78-79	

Profile Tiles

Lindum (also available in Sanded)²



Material	Concrete
Minimum roof pitch ¹	22.5°
Size of tile (mm)	420 x 334
Quantity per pallet	216
Covering capacity (per m ²) * 9.7 tiles	
Full product details on page 16-17	

Standard Pattern (also available in Sanded)²



Material	Concrete
Minimum roof pitch ¹	17.5° - 22.5° [†]
Size of tile (mm)	380 x 230
Quantity per pallet	360
Covering capacity (per m ²) 17.9 - 16.4 tiles	
Full product details on page 18-19	

COLOUR RANGE

Contents

Concrete	7
Clay	8-9
Keymer	10

Concrete Colours - Sanded

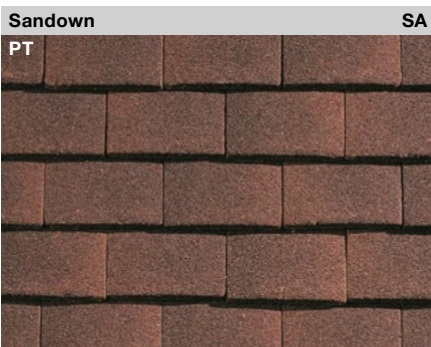
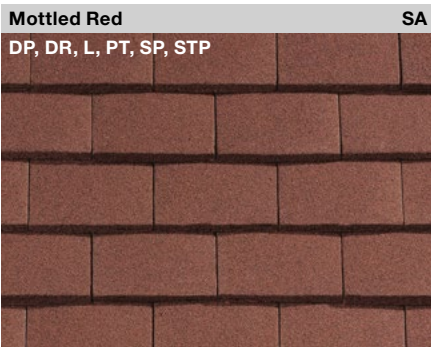
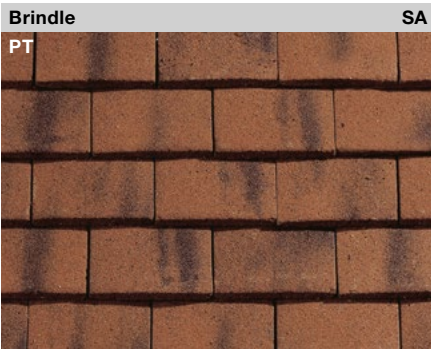

Concrete Colours - Smooth

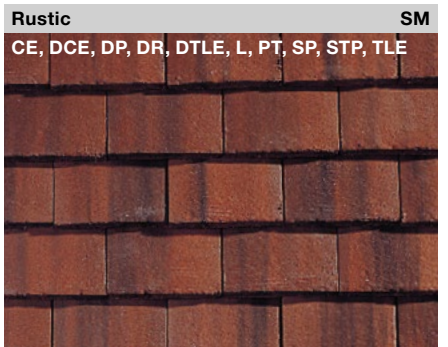
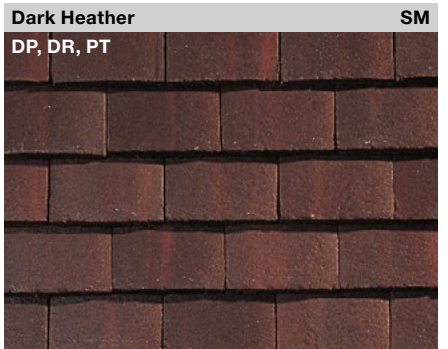
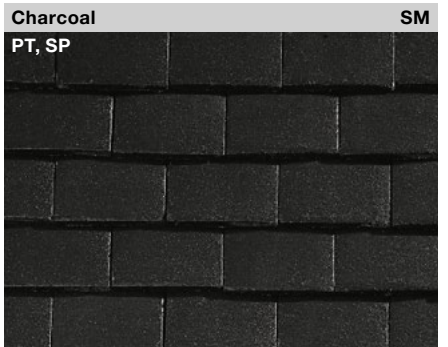
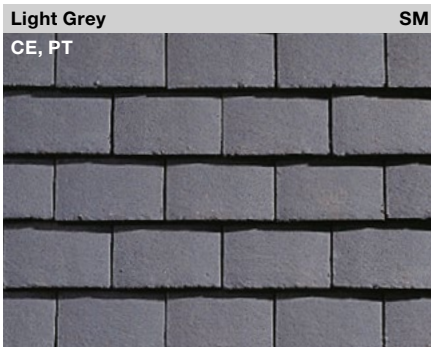

Key	
CE	Calderdale Edge
DCE	Dual Calderdale Edge
DP	Double Pantile
DR	Double Roman
DTLE	Dual TLE
L	Lindum
PT	Plain Tile
SP	Shire Pantile
STP	Standard Pattern
TLE	TLE

SA Sanded SM Smooth

Please note that some colours may not be available from stock and lead times could apply, please call customer support for more information.

COLOUR RANGE

Natural Clay

Clay Colours - Sanded

Bay Brown SA



Buckingham SA



Burnt Oak SA



Dark Rusper SA

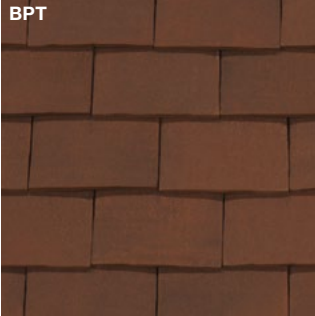

Kensington SA

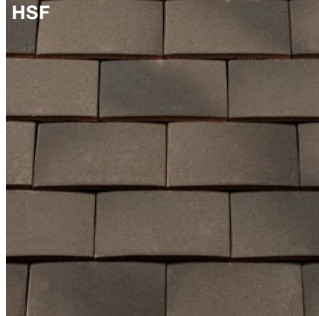

Light Rusper SA



Key

301	301 Plain Tile
303	303 Plain Tile
451	451 Old Hollow Pantile
ACT	Actua
AP	Arcadia Pantile
APT	Alban Plain Tile
BPT	Barrow Plain Tile
BRI	Bridgwater
CAS	Cassius
GSR	Gaelic Single Roman
HPT	Humber Plain Tile
HSF	Humber Sandfaced
MOD	Modula
NCP	New County Pantile
NP	Neo Plus
ODP	Olympus Double Pantile
OEP	Old English Pantile
RIV	Rivius
T44	Tempest 44 Single Roman
TT	20/20
VAU	Vauban
VPT	Village Plain Tile

Old Heather SA

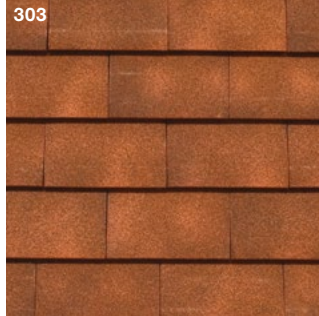

Old Rustic SA

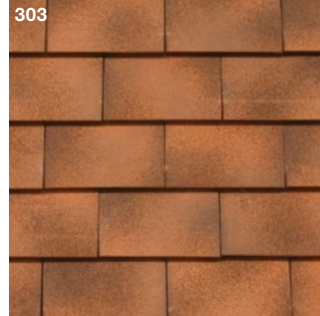

Old Weathered SA

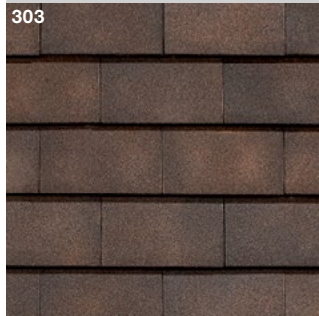

Sussex Blend SA



Clay Colours - Smooth

Natural Red SM



Flanders SM

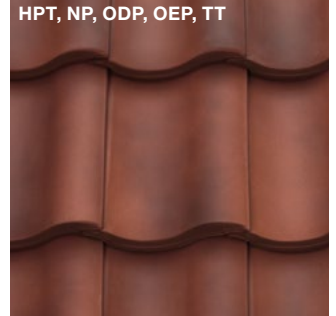

Antique Slate SM

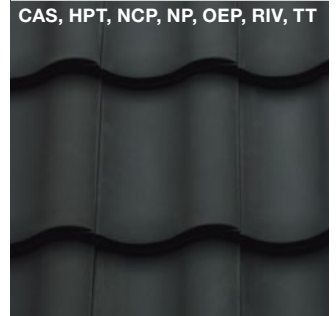

Tuscan SM

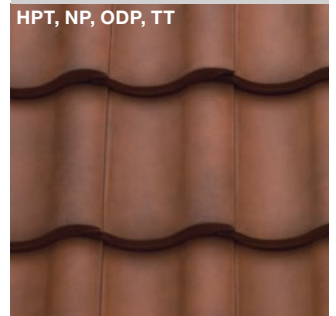

Clay Smooth

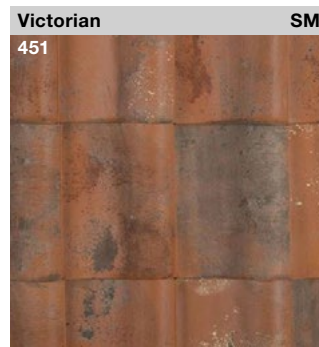
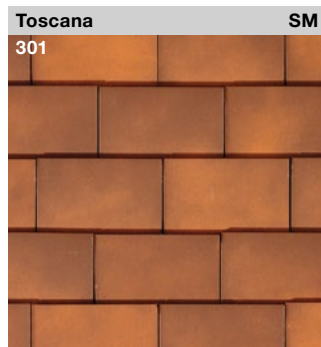
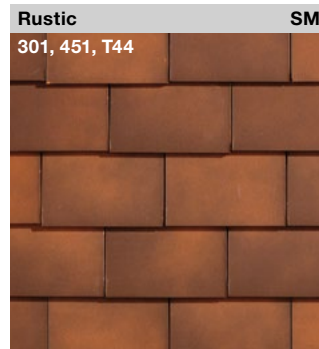
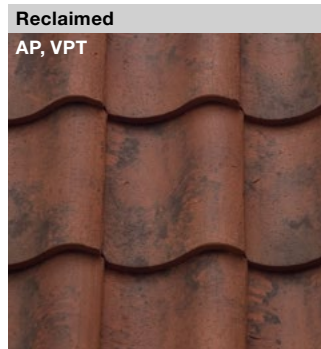
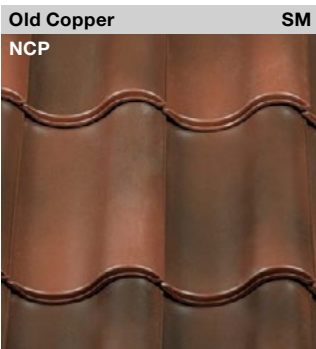
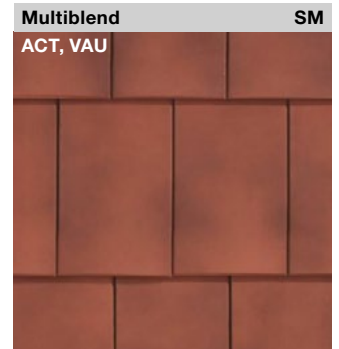
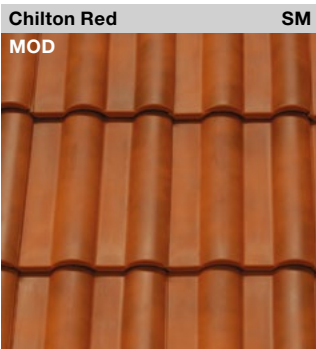
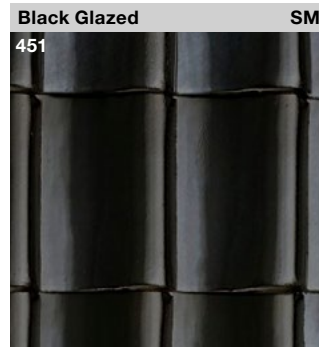
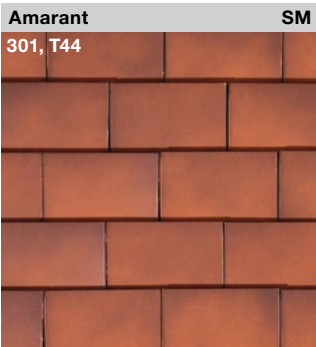

COLOUR RANGE

Keymer

Keymer Colours

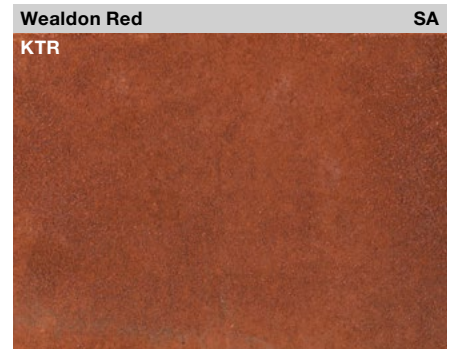
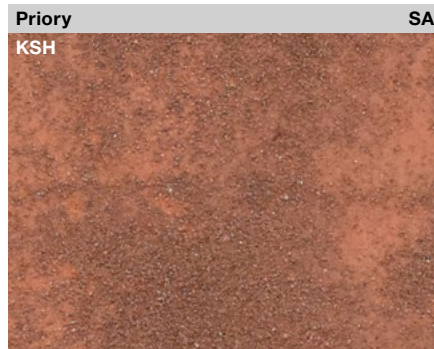
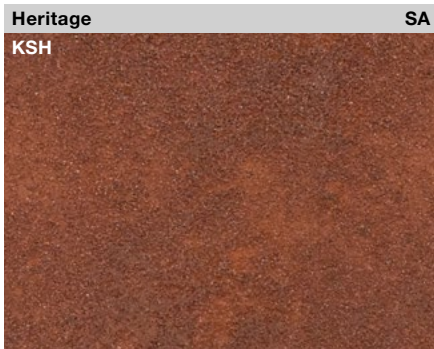
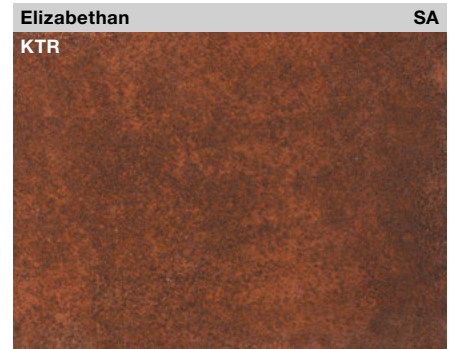
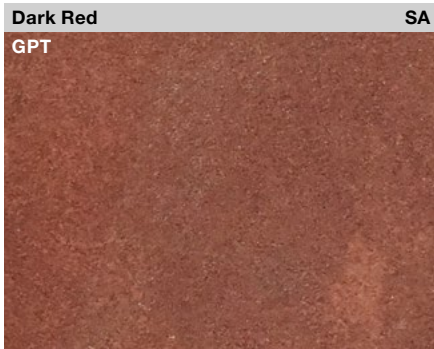
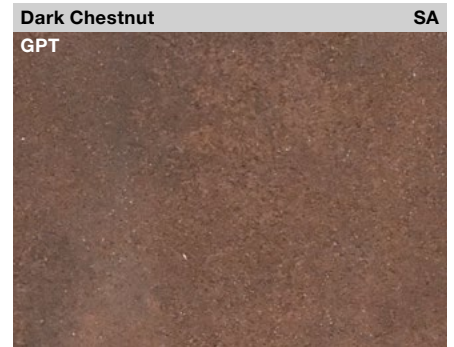
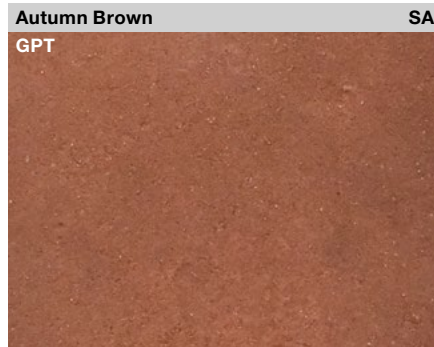
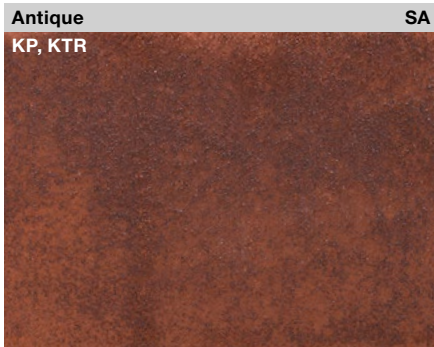

Clay is a natural and sustainable roofing material which is inherently strong and provides richness in colour which will not fade. The rich colouring of natural clay provides roofs with great beauty and character which becomes more attractive with age.

Clay tiles are manufactured to give a harmonious appearance to the finished roof. However, slight colour variations may occur as a consequence of the production process. It is therefore advisable not to mix tiles from different batches or of different colours on the roof. To achieve the best effect, tiles should be taken from several pallets and mixed at random on the roof.

Clay tiles are subject to small variations in size because of drying and firing shrinkage in the manufacturing process. Therefore, before deciding on the batten gauge and cover width, the roof tiler should inspect each batch of tiles to ensure that the correct minimum headlap and sidelap are achieved.

Key	
GPT	Goxhill Plain Tile
KP	Peg Tile
KSH	Shire Plain Tile
KTR	Traditional Plain Tile

SA Sanded SM Smooth



CONCRETE

Contents

Plain Tile	14-15
Lindum	16-17
Standard Pattern	18-19
Shire Pantile	20-21
Calderdale Edge	22-23
Dual Calderdale Edge	24-25
TLE	26-27
Dual TLE	28-29
Double Roman	30-31
Double Pantile	32-33



PLAIN TILE

Concrete



This versatile cross-cambered concrete tile is perfect for complex detailing and curved roof applications.

Product Technical Information Sheet

Roof Tiling

Minimum roof pitch	35°
Headlap (minimum)	65 mm
Batten spacing at maximum gauge	100 mm
Size of tile	265 x 165 mm
Covering capacity	60 tiles per m ²
Cover width	165 mm
Profile depth	13 mm
Hanging length	245 mm
Weight as laid	78.0 kg per m ²
Weight per 1000 (including pallet and packaging)	1.322 tonnes
Weight per tile	1.3 kg
Weight per pallet (including pallet and packaging)	1.015 tonnes
Bond	Cross / Broken
Quantity per pallet	768
Battens per m ²	10 m
Batten size - up to 600mm rafter centres	38 x 25 mm
Nail size/type for tiles	38 x 3.35 mm aluminium ring shank clout head

Vertical Tiling

Minimum roof pitch	75°
Headlap (minimum)	38 mm
Batten spacing at maximum gauge	114 mm
Size of tile	265 x 165 mm
Covering capacity	53 tiles per m ²
Cover width	165 mm
Profile depth	13 mm
Hanging length	245 mm
Weight as laid	68.9 kg per m ²
Weight per 1000 (including pallet and packaging)	1.322 tonnes
Weight per tile	1.3 kg
Weight per pallet (including pallet and packaging)	1.015 tonnes
Bond	Cross / Broken
Quantity per pallet	768
Battens per m ²	8.8 m
Batten size - up to 600mm rafter centres	38 x 25 mm
Nail size/type for tiles	38 x 3.35 mm aluminium ring shank clout head

Unless otherwise stated, data is based on the tiles laid at minimum headlap. Before deciding on the batten gauge and linear coverage, the roof tiler should inspect each batch of tiles to ensure that the correct minimum headlap and sidelap are achieved.

Product specification is subject to change and will be updated accordingly.

Note: Lead times may apply. Colour availability may vary.

Smooth

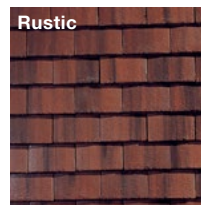
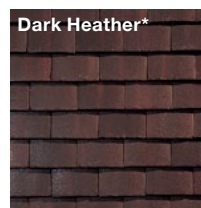
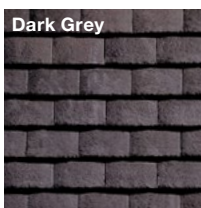
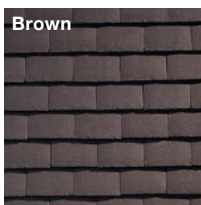

Sanded

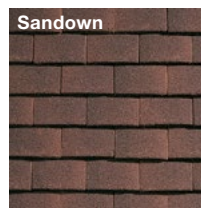
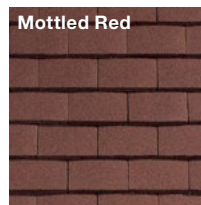
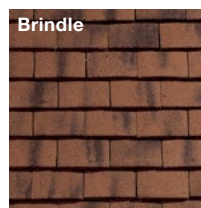

Tile Fixing

Sandtoft roof tiles must be laid and fixed to comply with BS 5534: the British Standard Code of practice for slating and tiling, and BS 8000: Part 6: the British Standard Code of practice for workmanship on building sites. To ensure compliance with these Standards we strongly recommend that a calculated fixing specification be obtained from Sandtoft Technical Support or using Sandtoft's online tool at www.all4roof.co.uk



* Lead times may apply. ** For use as fitting only.

Due to the limitations of the printing process and screen calibration settings images shown may not be an accurate representation of the final product colour. Please obtain a sample if unsure.

Fittings

Eaves/Tops Tile

200 x 165 x 13mm



Tile and a Half

265 x 247 x 13mm



Bonnet Hip

225 x 230mm



Valley Tile

270 x 310mm



External Angle

265 x 165 x 80mm



Feature Tile (Club)

265 x 165mm



LH and RH available in both 90° and 135°
(LH 90° shown)

Additional Fittings

Arris Hip (35° & 40°)

Internal Angle 90° (LH & RH)

Cloaked Verge (LH & RH)

Accessories

InvisiVent¹

490 x 310mm



Associated Ridge / Hip

Half Round Ridge 457mm



Segmental Ridge 457mm



Tile Dimensions

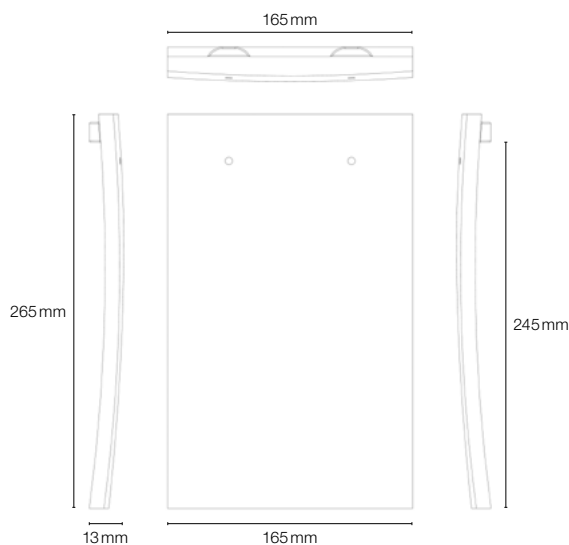

Associated Systems

Dry Ridge/Hip Systems

HR Roll Ridge Pack 6m CON

HR Profile Ridge Pack 6m CON

Seg Roll Hip Pack 6m CON

HR Profile MonoRidge Pack 6m CON

Additional Systems

10mm Eaves Ventilation Pack

25mm Eaves Ventilation Pack

Top Abutment Ventilator Kit

BIM Object
Download



¹ Requires Pipe Adaptor & Flexi Pipe for connection to soil or mechanical extraction.

All dimensions are nominal and taken from the drawing.

Actual product dimensions may vary slightly from those referenced above.



An interlocking concrete tile which provides a classic low profile roof.

Product Technical Information Sheet

Roof Tiling	
Minimum roof pitch	22.5° smooth at 100mm headlap 30° sanded at 75mm headlap
Headlap (minimum)	75mm
Headlap (maximum)	120mm
Batten spacing at maximum gauge	345mm
Batten spacing at minimum gauge	300mm
Size of tile	420 x 334mm
Covering capacity	9.7 tiles per m ²
Cover width	300mm
Profile depth	42mm
Hanging length	401mm
Weight as laid	45.2 kg per m ²
Weight per 1000 (including pallet and packaging)	4.71 tonnes
Weight per tile	4.65 kg
Weight per pallet (including pallet and packaging)	1.017 tonnes
Bond	Straight
Quantity per pallet	216
Battens per m ²	2.9m at 75mm headlap
Batten size - up to 450mm rafter centres	38 x 25mm
Batten size - up to 600mm rafter centres	50 x 25mm
Nail size/type for tiles	50 x 3.35mm aluminium ring shank clout head
Nail size/type for tile clips	50 x 3.35mm aluminium ring shank clout head

Unless otherwise stated, data is based on the tiles laid at minimum headlap. Before deciding on the batten gauge and linear coverage, the roof tiler should inspect each batch of tiles to ensure that the correct minimum headlap and sidelap are achieved.

Product specification is subject to change and will be updated accordingly.

Note: Lead times may apply. Colour availability may vary.

Smooth

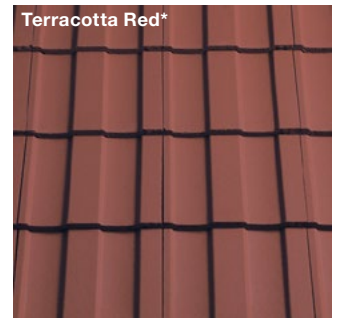
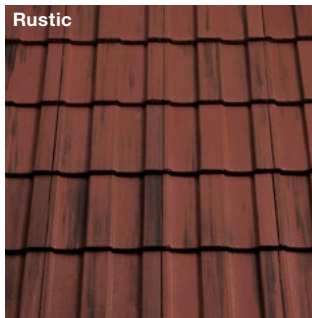
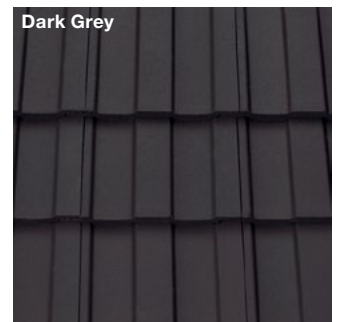
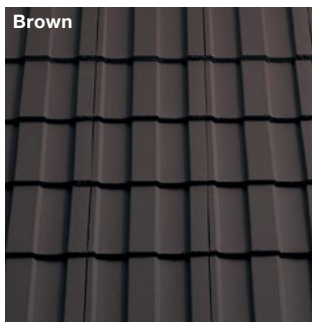

Sanded

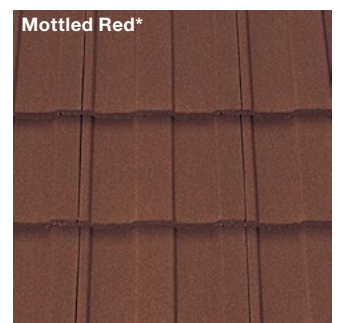
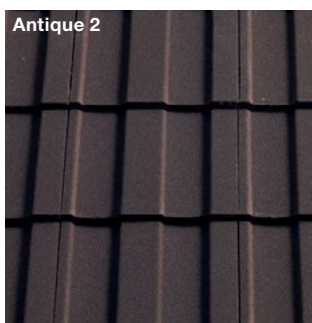

Tile Fixing

Sandtoft roof tiles must be laid and fixed to comply with BS 5534: the British Standard Code of practice for slating and tiling, and BS 8000: Part 6: the British Standard Code of practice for workmanship on building sites. To ensure compliance with these Standards we strongly recommend that a calculated fixing specification be obtained from Sandtoft Technical Support or using Sandtoft's online tool at www.all4roof.co.uk

* Lead times may apply.

Due to the limitations of the printing process and screen calibration settings images shown may not be an accurate representation of the final product colour. Please obtain a sample if unsure.

Accessories

Tile Clip

Nail size 50 x 3.35 mm



Eaves Clip¹

Nail size 20 x 3.35 mm



Verge Clip

Nail size 20 x 3.35 mm



Additional Accessories

Cowl Vent^{2,3}

Associated Ridge / Hip

Half Round Ridge 457 mm



Segmental Ridge 457 mm



Tile Dimensions

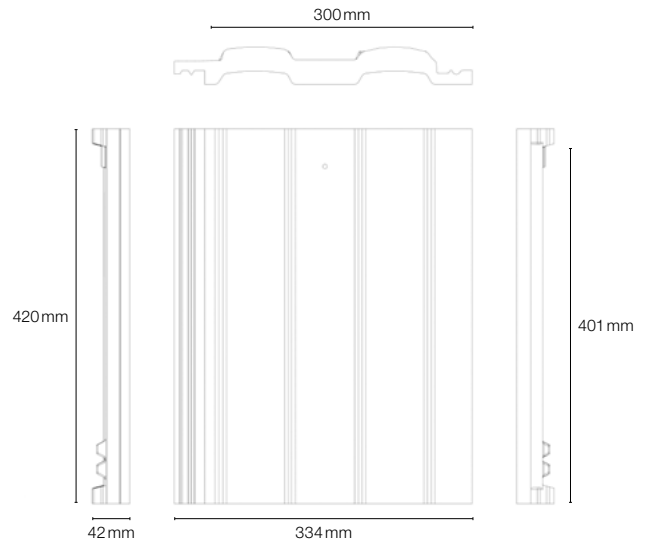

Associated Systems

Dry Ridge/Hip Systems

HR Roll Ridge Pack 6m CON
HR Profile Ridge Pack 6m CON⁴
Seg Roll Hip Pack 6m CON
HR Profile MonoRidge Pack 6m CON⁴
Mortarless Hip/Valley Tile Top Clip
Mortarless Hip/Valley Tail Clip STD
Profile Dry Ridge Fillers

Dry Verge Systems

LH Multiverge Unit
RH Multiverge Unit
LH Multiverge Eaves Unit
RH Multiverge Eaves Unit
Ridge Closure Comb
Ridge End Cap

Additional Systems

10 mm Eaves Ventilation Pack
25 mm Eaves Ventilation Pack
Top Abutment Ventilator Kit⁴

BIM Object
Download



¹ When used in conjunction with Over Fascia Ventilator Strip, nail length should be increased to 40mm for 10mm Over Fascia Ventilator Strip, or 50mm for 25mm Over Fascia Ventilator Strip.

² Requires Flexi Pipe for connection to soil or mechanical extraction.

³ Not suitable for roof pitches below 22.5°.

⁴ Profile Dry Ridge Fillers sold separately in box quantities sufficient for 6m of Ridge/12m of MonoRidge.

All dimensions are nominal and taken from the drawing.
Actual product dimensions may vary slightly from those referenced above.

STANDARD PATTERN

Concrete



Easy to install and highly durable, this tile is ideal for re-roofing and comes in convenient banded packs of eight.

Product Technical Information Sheet

Roof Tiling	
Minimum roof pitch*	17.5° smooth at 100mm headlap 22.5° smooth at 75mm headlap 30° sanded at 75mm headlap
Headlap (minimum)	75mm
Headlap (maximum)	120mm
Batten spacing at maximum gauge	305mm
Batten spacing at minimum gauge	260mm
Size of tile	380 x 230mm
Covering capacity	17.9 tiles per m ² at 100mm headlap
	16.4 tiles per m ² at 75mm headlap
Cover width	200mm
Profile depth	40mm
Hanging length	355mm
Weight as laid	52.9kg per m ² at 100mm headlap
	48.4kg per m ² at 75mm headlap
Weight per 1000 (including pallet and packaging)	3.0 tonnes
Weight per tile	2.95kg
Weight per pallet (including pallet and packaging)	1.078 tonnes
Bond	Straight
Quantity per pallet	360
Battens per m ²	3.6m at 100mm headlap
	3.3m at 75mm headlap
Batten size - up to 450mm rafter centres	38 x 25mm
Batten size - up to 600mm rafter centres	50 x 25mm
Nail size/type for tiles	50 x 3.35mm aluminium ring shank clout head
Nail size/type for tile clips	55 x 3.35mm aluminium ring shank clout head

Unless otherwise stated, data is based on the tiles laid at minimum headlap. Before deciding on the batten gauge and linear coverage, the roof tiler should inspect each batch of tiles to ensure that the correct minimum headlap and sidelap are achieved.

*For projects where the rafters are below 22.5 degrees the roof substructure must be installed in accordance with the Sandtoft low pitch installation guide. Rafter length restrictions apply at minimum roof pitch.

Product specification is subject to change and will be updated accordingly.

Note: Lead times may apply. Colour availability may vary.

Smooth

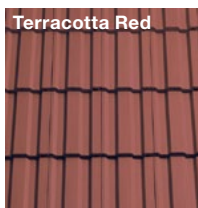
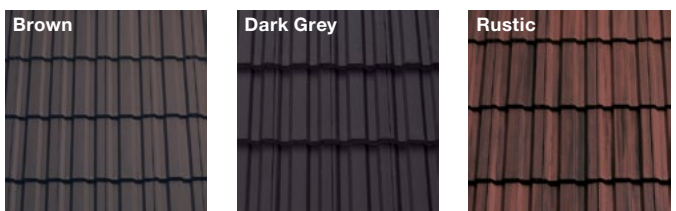

Sanded



Tile Fixing

Sandtoft roof tiles must be laid and fixed to comply with BS 5534: the British Standard Code of practice for slating and tiling, and BS 8000: Part 6: the British Standard Code of practice for workmanship on building sites. To ensure compliance with these Standards we strongly recommend that a calculated fixing specification be obtained from Sandtoft Technical Support or using Sandtoft's online tool at www.all4roof.co.uk

All4Roof

** Lead times may apply.

Due to the limitations of the printing process and screen calibration settings images shown may not be an accurate representation of the final product colour. Please obtain a sample if unsure.

Accessories

Tile Clip

Nail size 55 x 3.35 mm



Eaves Clip¹

Nail size 20 x 3.35 mm



Verge Clip

Nail size 20 x 3.35 mm



Associated Ridge / Hip

Half Round Ridge 457 mm



Segmental Ridge 457 mm



Tile Dimensions

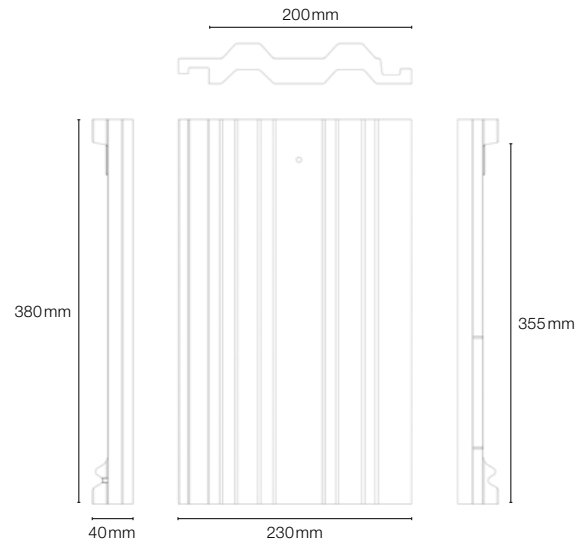

Associated Systems

Dry Ridge/Hip Systems

- HR Roll Ridge Pack 6m CON
- HR Profile Ridge Pack 6m CON²
- Seg Roll Hip Pack 6m CON
- HR Profile MonoRidge Pack 6m CON²
- Mortarless Hip/Valley Tile Top Clip
- Mortarless Hip/Valley Tail Clip STD
- Profile Dry Ridge Fillers

Dry Verge Systems

- LH Multiverge Unit
- RH Multiverge Unit
- LH Multiverge Eaves Unit
- RH Multiverge Eaves Unit
- Ridge Closure Comb
- Ridge End Cap

Additional Systems

- 10 mm Eaves Ventilation Pack
- 25 mm Eaves Ventilation Pack
- Top Abutment Ventilator Kit²

BIM Object
Download



¹ When used in conjunction with Over Fascia Ventilator Strip, nail length should be increased to 40 mm for 10 mm Over Fascia Ventilator Strip, or 50 mm for 25 mm Over Fascia Ventilator Strip.

² Profile Dry Ridge Fillers sold separately in box quantities sufficient for 6 m of Ridge/12 m of MonoRidge.

All dimensions are nominal and taken from the drawing.
Actual product dimensions may vary slightly from those referenced above.

SHIRE PANTILE

Concrete



This classic pantile is now re-engineered for easier installation and improved performance.

Product Technical Information Sheet

Roof Tiling	
Minimum roof pitch	17.5° smooth 30° sanded
Headlap (minimum)	75 mm
Headlap (maximum)	120 mm
Batten spacing at maximum gauge	305 mm
Batten spacing at minimum gauge	260 mm
Size of tile	380 x 230 mm
Covering capacity	16.4 tiles per m ² at 75 mm headlap
Cover width	200 mm
Profile depth	70 mm
Hanging length	360 mm
Weight as laid	46.5 kg per m ² at 75 mm headlap
Weight per 1000 (including pallet and packaging)	2.88 tonnes
Weight per tile	2.83 kg
Weight per pallet (including pallet and packaging)	1.036 tonnes
Bond	Straight
Quantity per pallet	360
Battens per m ²	3.3 m at 75 mm headlap
Batten size - up to 450mm rafter centres	38 x 25 mm
Batten size - up to 600mm rafter centres	50 x 25 mm
Nail size/type for tiles	38 x 3.35 mm aluminium ring shank clout head
Nail size/type for metal tile clips	50 x 3.35 mm aluminium ring shank clout head

Unless otherwise stated, data is based on the tiles laid at minimum headlap. Before deciding on the batten gauge and linear coverage, the roof tiler should inspect each batch of tiles to ensure that the correct minimum headlap and sidelap are achieved.

Product specification is subject to change and will be updated accordingly.

Note: Lead times may apply. Colour availability may vary.

Smooth

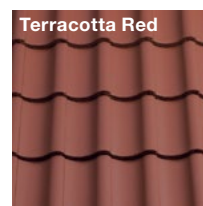
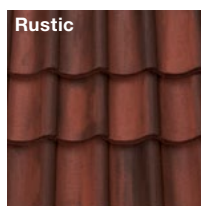
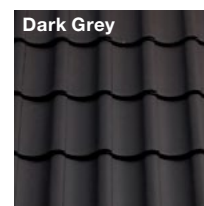
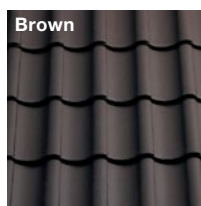

Sanded

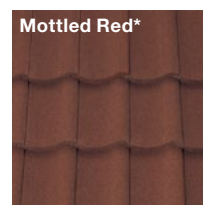
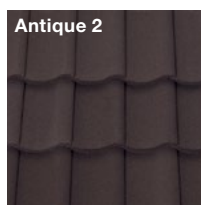

Tile Fixing

Sandtoft roof tiles must be laid and fixed to comply with BS 5534: the British Standard Code of practice for slating and tiling, and BS 8000: Part 6: the British Standard Code of practice for workmanship on building sites. To ensure compliance with these Standards we strongly recommend that a calculated fixing specification be obtained from Sandtoft Technical Support or using Sandtoft's online tool at www.all4roof.co.uk

All4Roof

* Lead times may apply.

Due to the limitations of the printing process and screen calibration settings images shown may not be an accurate representation of the final product colour. Please obtain a sample if unsure.

Accessories

Tile Clip

Nail size 50 x 3.35 mm



Eaves Clip¹

Nail size 20 x 3.35 mm



Verge Clip

Nail size 20 x 3.35 mm



In-Line Vent^{2,4}

430 x 385 x 125 mm



Smoothfaced colours only

Additional Accessories

Cowl Vent^{3,4}

Associated Ridge / Hip

Half Round Ridge 457 mm



Segmental Ridge 457 mm



Tile Dimensions

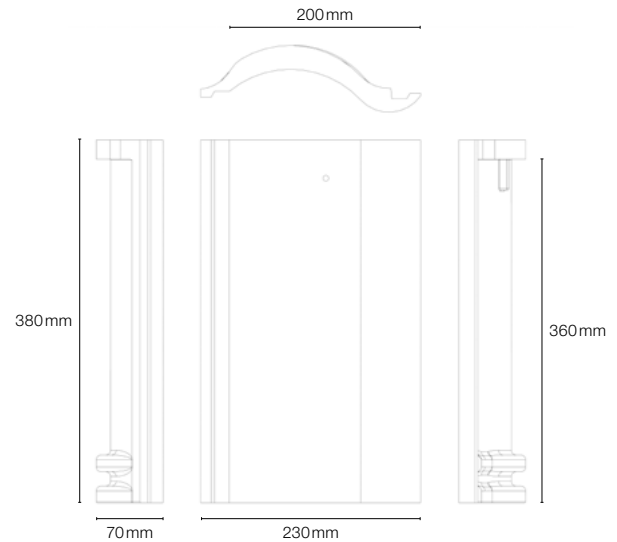

Associated Systems

Dry Ridge/Hip Systems

HR Roll Ridge Pack 6m CON
HR Profile Ridge Pack 6m CON⁵
Seg Roll Hip Pack 6m CON
HR Profile MonoRidge Pack 6m CON⁵
Mortarless Hip/Valley Tile Top Clip
Mortarless Hip/Valley Tail Clip STD
Profile Dry Ridge Fillers
Dentil Slip

Dry Verge Systems

LH Multiverge Unit
RH Multiverge Unit
LH Multiverge Eaves Unit
RH Multiverge Eaves Unit
Ridge Closure Comb
Ridge End Cap

Additional Systems

10mm Eaves Ventilation Pack
25mm Eaves Ventilation Pack
Top Abutment Ventilator Kit⁵
Bird Comb Filler

BIM Object
Download



¹ When used in conjunction with Over Fascia Ventilator Strip, nail length should be increased to 40mm for 10mm Over Fascia Ventilator Strip, or 50mm for 25mm Over Fascia Ventilator Strip.
² Requires Pipe Adaptor & Flexi Pipe for connection to soil or mechanical extraction.
³ Requires Flexi Pipe for connection to soil or mechanical extraction.
⁴ Not suitable for roof pitches below 22.5°.
⁵ Profile Dry Ridge Fillers sold separately in box quantities sufficient for 6m of Ridge/12m of Monoridge.

All dimensions are nominal and taken from the drawing.
Actual product dimensions may vary slightly from those referenced above.

CALDERDALE EDGE Concrete



Calderdale Edge...sometimes it's taking a product you know, and re-engineering it to be quicker, stronger and better value.

Product Technical Information Sheet

Roof Tiling

Minimum roof pitch*	16.5° at 100mm headlap 22.5° at 75mm headlap
Headlap (minimum)	75mm
Headlap (maximum)	120mm
Batten spacing at maximum gauge	345mm
Batten spacing at minimum gauge	300mm
Size of tile	420 x 334mm
Covering capacity	10.2 tiles per m ² at 100mm headlap
	9.5 tiles per m ² at 75mm headlap
Cover width	307mm
Profile depth	28mm
Hanging length	405mm
Weight as laid	50.5 kg per m ² at 100mm headlap
	47.1 kg per m ² at 75mm headlap
Weight per 1000 (including pallet and packaging)	5.104 tonnes
Weight per tile	4.95 kg
Weight per pallet (including pallet and packaging)	0.980 tonnes
Bond	Cross / Broken
Quantity per pallet	192
Battens per m ²	3.2m at 100mm headlap
	2.9m at 75mm headlap
Batten size - up to 450mm rafter centres	38 x 25mm
Batten size - up to 600mm rafter centres	50 x 25mm
Nail size/type for tiles	50 x 3.35mm aluminium ring shank clout head
Nail size/type for tile clips	Nail included within the clip

Unless otherwise stated, data is based on the tiles laid at minimum headlap. Before deciding on the batten gauge and linear coverage, the roof tiler should inspect each batch of tiles to ensure that the correct minimum headlap and sidelap are achieved.

*For projects where the rafters are below 22.5 degrees the roof substructure must be installed in accordance with the Sandtoft low pitch installation guide. Rafter length restrictions apply at minimum roof pitch.

Product specification is subject to change and will be updated accordingly.

Note: Lead times may apply. Colour availability may vary.

Smooth

Brown

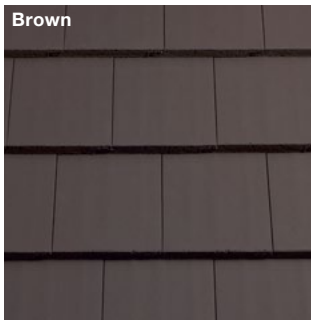

Dark Grey

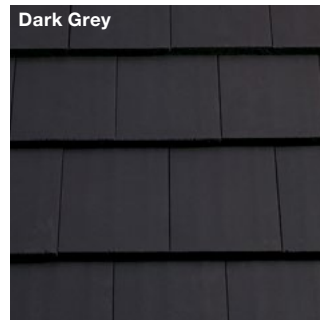

Light Grey

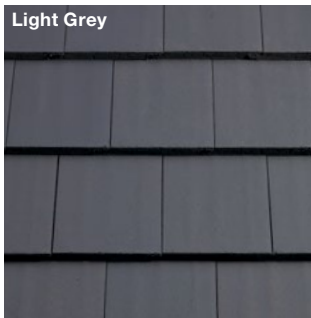

Rustic

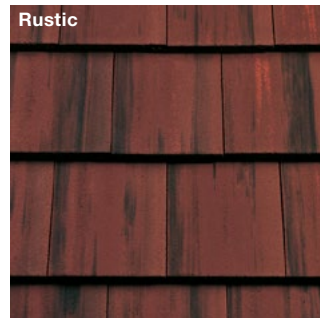

Terracotta Red

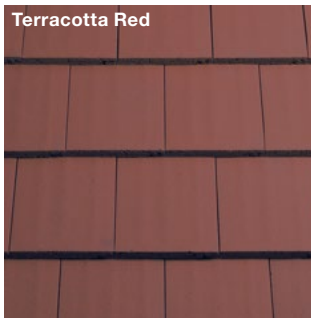

Tile Fixing

Sandtoft roof tiles must be laid and fixed to comply with BS 5534: the British Standard Code of practice for slating and tiling, and BS 8000: Part 6: the British Standard Code of practice for workmanship on building sites. To ensure compliance with these Standards we strongly recommend that a calculated fixing specification be obtained from Sandtoft Technical Support or using Sandtoft's online tool at www.all4roof.co.uk

All4Roof

Fittings

Left Hand Verge

420 x 307 x 28mm



Made to order

Half Tile Pair

420 x 334 x 28mm



Made to order

Accessories

Monkey Grip Tile Clip

Nail integrated with clip



Monkey Grip Eaves Clip¹

Nail size 20 x 3.35mm



Verge Clip

Nail size 20 x 3.35mm



In-Line Vent^{2,4}

421 x 335 x 85mm



Cowl Vent^{3,4}

420 x 334 x 13mm



Associated Ridge / Hip

Multi Angle Ridge 457 mm



Tile Dimensions

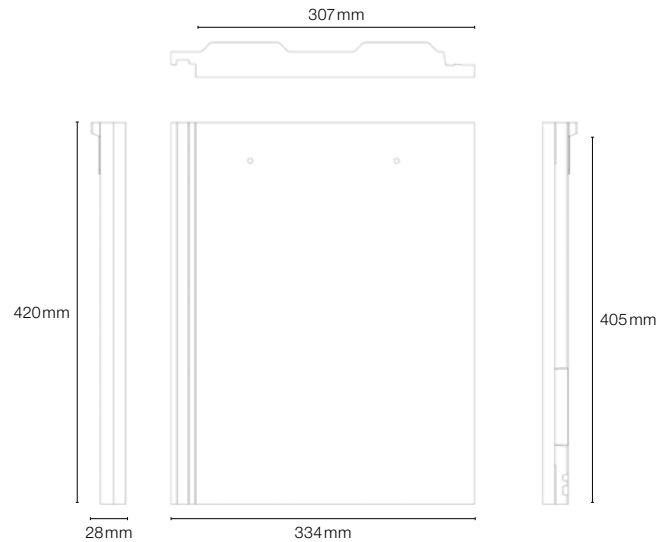

Associated Systems

Dry Ridge/Hip Systems

MA Profile Ridge Pack 6m
MA Roll Ridge & Hip Pack 6m
MA Profile MonoRidge Pack 6m
Mortarless Hip/Valley Tile Top Clip
Mortarless Hip/Valley Tail Clip STD

Additional Systems

10mm Eaves Ventilation Pack
25mm Eaves Ventilation Pack
Top Abutment Ventilator Kit

Dry Verge Systems

LH Multiverge Unit
RH Multiverge Unit
LH Multiverge Eaves Unit
RH Multiverge Eaves Unit
Ridge Closure Comb
Ridge End Cap

BIM Object
Download



¹ When used in conjunction with Over Fascia Ventilator Strip, nail length should be increased to 40mm for 10mm Over Fascia Ventilator Strip, or 50mm for 25mm Over Fascia Ventilator Strip.

² Requires Pipe Adaptor & Flexi Pipe for connection to soil or mechanical extraction.

³ Requires Flexi Pipe for connection to soil or mechanical extraction.

⁴ Not suitable for roof pitches below 22.5°.

All dimensions are nominal and taken from the drawing.
Actual product dimensions may vary slightly from those referenced above.

DUAL CALDERDALE EDGE Concrete



Dual Calderdale Edge gives a slate-like appearance and offers all the benefits of modern interlocking design.

Product Technical Information Sheet

Roof Tiling

Minimum roof pitch*	16.5° at 100mm headlap 22.5° at 75mm headlap
Headlap (minimum)	75mm
Headlap (maximum)	120mm
Batten spacing at maximum gauge	345mm
Batten spacing at minimum gauge	300mm
Size of tile	420 x 334mm
Covering capacity	10.52 tiles per m ² at 100mm headlap
	9.5 tiles per m ² at 75mm headlap
Cover width	307mm
Profile depth	28mm
Hanging length	405mm
Weight as laid	50.5 kg per m ² at 100mm headlap
	47.1 kg per m ² at 75mm headlap
Weight per 1000 (including pallet and packaging)	5.104 tonnes
Weight per tile	4.95 kg
Weight per pallet (including pallet and packaging)	980 kg
Bond	Quarter bond
Quantity per pallet	192
Battens per m ²	3.1 m at 100mm headlap
	2.9m at 75mm headlap
Batten size - up to 450mm rafter centres	38 x 25mm
Batten size - up to 600mm rafter centres	50 x 25mm
Nail size/type for tiles	50 x 3.35mm aluminium ring shank clout head
Nail size/type for tile clips	Nail included within the clip

Unless otherwise stated, data is based on the tiles laid at minimum headlap. Before deciding on the batten gauge and linear coverage, the roof tiler should inspect each batch of tiles to ensure that the correct minimum headlap and sidelap are achieved.

*For projects where the rafters are below 22.5 degrees the roof substructure must be installed in accordance with the Sandtoft low pitch installation guide. Rafter length restrictions apply at minimum roof pitch.

Product specification is subject to change and will be updated accordingly.

Note: Lead times may apply. Colour availability may vary.

Smooth

Dark Grey

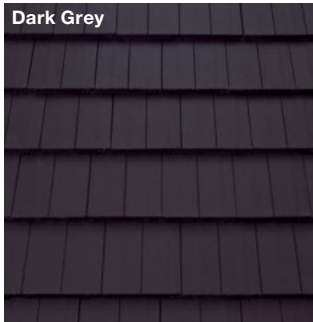

Rustic

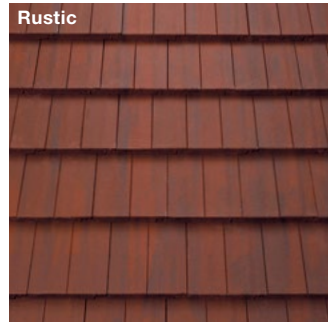

Tile Fixing

Sandtoft roof tiles must be laid and fixed to comply with BS 5534: the British Standard Code of practice for slating and tiling, and BS 8000: Part 6: the British Standard Code of practice for workmanship on building sites. To ensure compliance with these Standards we strongly recommend that a calculated fixing specification be obtained from Sandtoft Technical Support or using Sandtoft's online tool at www.all4roof.co.uk

All4Roof

Accessories

Monkey Grip Tile Clip

Nail integrated with clip



Eaves Clip¹

Nail size 20 x 3.35 mm



Verge Clip

Nail size 20 x 3.35 mm



In-Line Vent^{2,4}

421 x 335 x 85 mm



Cowl Vent^{3,4}

420 x 334 mm

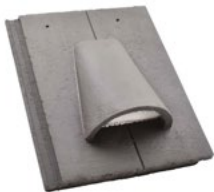

Associated Ridge / Hip

Multi Angle Ridge 457 mm



Tile Dimensions

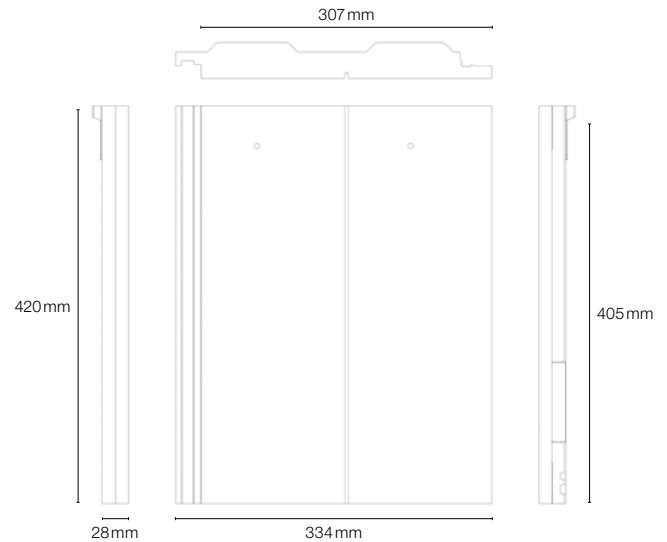

Associated Systems

Dry Ridge/Hip Systems

MA Profile Ridge Pack 6m
MA Roll Ridge & Hip Pack 6m
MA Profile MonoRidge Pack 6m
Mortarless Hip/Valley Tile Top Clip
Mortarless Hip/Valley Tail Clip STD

Additional Systems

10 mm Eaves Ventilation Pack
25 mm Eaves Ventilation Pack
Top Abutment Ventilator Kit

Dry Verge Systems

LH Multiverge Unit
RH Multiverge Unit
LH Multiverge Eaves Unit
RH Multiverge Eaves Unit
Ridge Closure Comb
Ridge End Cap

BIM Object
Download



¹ When used in conjunction with Over Fascia Ventilator Strip, nail length should be increased to 40mm for 10mm Over Fascia Ventilator Strip, or 50mm for 25mm Over Fascia Ventilator Strip.

² Requires Pipe Adaptor & Flexi Pipe for connection to soil or mechanical extraction.

³ Requires Flexi Pipe for connection to soil or mechanical extraction.

⁴ Not suitable for roof pitches below 22.5°.

All dimensions are nominal and taken from the drawing.
Actual product dimensions may vary slightly from those referenced above.

TLE Concrete



TLE is one of the thinnest leading edges on the market. It gives a slate-like appearance and offers all the benefits of a modern interlocking design.

Product Technical Information Sheet

Roof Tiling	
Minimum roof pitch	17.5° at 100mm headlap 22.5° at 75mm headlap
Headlap (minimum)	75mm
Headlap (maximum)	120mm
Batten spacing at maximum gauge	345mm
Batten spacing at minimum gauge	300mm
Size of tile	420 x 334mm
Covering capacity	10.3 tiles per m ² at 100mm headlap
	9.6 tiles per m ² at 75mm headlap
Cover width	305mm
Profile depth	21mm
Hanging length	400mm
Weight as laid	49.5 kg per m ² at 100mm headlap
	46.1 kg per m ² at 75mm headlap
Weight per 1000 (including pallet and packaging)	4.9 tonnes
Weight per tile	4.8kg
Weight per pallet (including pallet and packaging)	1.176 tonnes
Bond	Cross / Broken
Quantity per pallet	240
Battens per m ²	3.2m at 100mm headlap
	2.9m at 75mm headlap
Batten size - up to 450mm rafter centres	38 x 25mm
Batten size - up to 600mm rafter centres	50 x 25mm
Nail size/type for tiles	45 x 3.35mm aluminium ring shank clout head
Nail size/type for tile clips	Nail included within the clip

Unless otherwise stated, data is based on the tiles laid at minimum headlap. Before deciding on the batten gauge and linear coverage, the roof tiler should inspect each batch of tiles to ensure that the correct minimum headlap and sidelap are achieved.

*For projects where the rafters are below 22.5 degrees the roof substructure must be installed in accordance with the Sandtoft low pitch installation guide. Rafter length restrictions apply at minimum roof pitch.

Product specification is subject to change and will be updated accordingly.

Note: Lead times may apply. Colour availability may vary.

Smooth

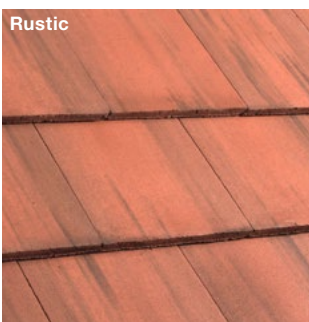
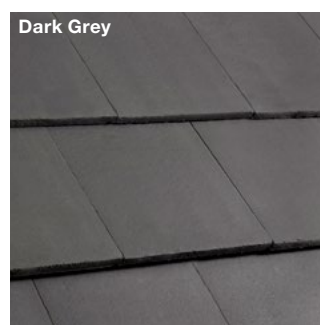

Tile Fixing

Sandtoft roof tiles must be laid and fixed to comply with BS 5534: the British Standard Code of practice for slating and tiling, and BS 8000: Part 6: the British Standard Code of practice for workmanship on building sites. To ensure compliance with these Standards we strongly recommend that a calculated fixing specification be obtained from Sandtoft Technical Support or using Sandtoft's online tool at www.all4roof.co.uk



** Made to order.

Due to the limitations of the printing process and screen calibration settings images shown may not be an accurate representation of the final product colour. Please obtain a sample if unsure.

Fittings

Left Hand Verge

420 x 305 x 19mm



Made to order

Half Tile Set

420 x 334 x 19mm



Made to order

Accessories

Monkey Grip Tile Clip

Nail integrated with clip



Monkey Grip Eaves Clip¹

Nail size 20 x 3.35mm



Verge Clip

Nail size 20 x 3.35mm



In-Line Vent^{2,4}

435 x 337 x 85mm



Cowl Vent^{3,4}

420 x 334mm



Associated Ridge / Hip

Multi Angle Ridge 457 mm



Tile Dimensions

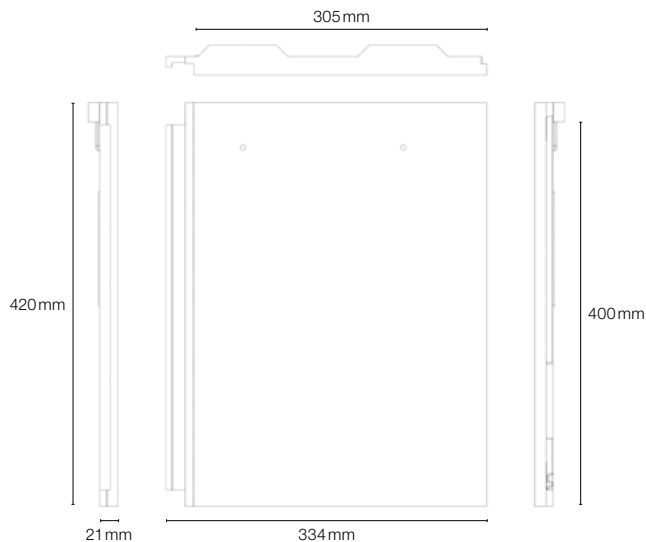

Associated Systems

Dry Ridge/Hip Systems

MA Profile Ridge Pack 6m
MA Roll Ridge & Hip Pack 6m
MA Profile MonoRidge Pack 6m
Mortarless Hip/Valley Tile Top Clip
Mortarless Hip/Valley Tail Clip TLE

Additional Systems

10mm Eaves Ventilation Pack
25mm Eaves Ventilation Pack
Top Abutment Ventilator Kit

Dry Verge Systems

LH Multiverge Unit
RH Multiverge Unit
LH Multiverge Eaves Unit
RH Multiverge Eaves Unit
Ridge Closure Comb
Ridge End Cap

BIM Object
Download



¹ When used in conjunction with Over Fascia Ventilator Strip, nail length should be increased to 40mm for 10mm Over Fascia Ventilator Strip, or 50mm for 25mm Over Fascia Ventilator Strip.

² Requires Pipe Adaptor & Flexi Pipe for connection to soil or mechanical extraction.

³ Requires Flexi Pipe for connection to soil or mechanical extraction.

⁴ Not suitable for roof pitches below 22.5°.

All dimensions are nominal and taken from the drawing.
Actual product dimensions may vary slightly from those referenced above.

DUAL TLE Concrete



Dual TLE is one of the thinnest leading edges on the market. It gives a slate-like appearance and offers all the benefits of a modern interlocking design.

Product Technical Information Sheet

Roof Tiling	
Minimum roof pitch*	17.5° at 100mm headlap 22.5° at 75mm headlap
Headlap (minimum)	75mm
Headlap (maximum)	120mm
Batten spacing at maximum gauge	345mm
Batten spacing at minimum gauge	300mm
Size of tile	420 x 334mm
Covering capacity	10.3 tiles per m ² at 100mm headlap
	9.6 tiles per m ² at 75mm headlap
Cover width	305mm
Profile depth	21mm
Hanging length	400mm
Weight as laid	49.5 kg per m ² at 100mm headlap
	46.1 kg per m ² at 75mm headlap
Weight per 1000 (including pallet and packaging)	4.9 tonnes
Weight per tile	4.8kg
Weight per pallet (including pallet and packaging)	1.176 tonnes
Bond	Quarter bond
Quantity per pallet	240
Battens per m ²	3.2m at 100mm headlap
	2.9m at 75mm headlap
Batten size - up to 450mm rafter centres	38 x 25mm
Batten size - up to 600mm rafter centres	50 x 25mm
Nail size/type for tiles	45 x 3.35mm aluminium ring shank clout head
Nail size/type for tile clips	Nail included within the clip

Unless otherwise stated, data is based on the tiles laid at minimum headlap. Before deciding on the batten gauge and linear coverage, the roof tiler should inspect each batch of tiles to ensure that the correct minimum headlap and sidelap are achieved.

*For projects where the rafters are below 22.5 degrees the roof substructure must be installed in accordance with the Sandtoft low pitch installation guide. Rafter length restrictions apply at minimum roof pitch.

Product specification is subject to change and will be updated accordingly.

Note: Lead times may apply. Colour availability may vary.

Smooth

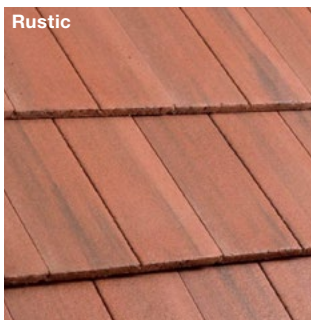
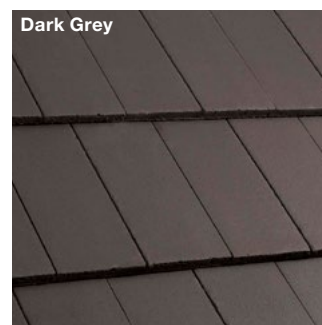
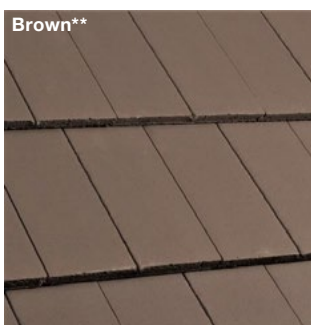

Tile Fixing

Sandtoft roof tiles must be laid and fixed to comply with BS 5534: the British Standard Code of practice for slating and tiling, and BS 8000: Part 6: the British Standard Code of practice for workmanship on building sites. To ensure compliance with these Standards we strongly recommend that a calculated fixing specification be obtained from Sandtoft Technical Support or using Sandtoft's online tool at www.all4roof.co.uk

All4Roof

** Made to order.

Due to the limitations of the printing process and screen calibration settings images shown may not be an accurate representation of the final product colour. Please obtain a sample if unsure.

Accessories

Monkey Grip Tile Clip

Nail integrated with clip



Eaves Clip¹

Nail size 20 x 3.35 mm



Verge Clip

Nail size 20 x 3.35 mm



In-Line Vent^{2,4}

435 x 337 x 85 mm



Cowl Vent^{3,4}

420 x 334 mm



Associated Ridge / Hip

Multi Angle Ridge 457 mm



Tile Dimensions

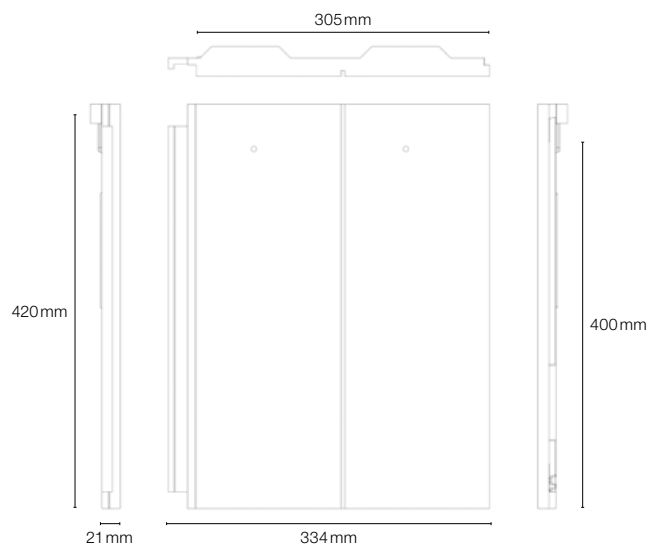

Associated Systems

Dry Ridge/Hip Systems

- MA Profile Ridge Pack 6m
- MA Roll Ridge & Hip Pack 6m
- MA Profile MonoRidge Pack 6m
- Mortarless Hip/Valley Tile Top Clip
- Mortarless Hip/Valley Tail Clip TLE

Dry Verge Systems

- LH Multiverge Unit
- RH Multiverge Unit
- LH Multiverge Eaves Unit
- RH Multiverge Eaves Unit
- Ridge Closure Comb
- Ridge End Cap

Additional Systems

- 10 mm Eaves Ventilation Pack
- 25 mm Eaves Ventilation Pack
- Top Abutment Ventilator Kit

BIM Object
Download



¹ When used in conjunction with Over Fascia Ventilator Strip, nail length should be increased to 40mm for 10mm Over Fascia Ventilator Strip, or 50mm for 25mm Over Fascia Ventilator Strip.

² Requires Pipe Adaptor & Flexi Pipe for connection to soil or mechanical extraction.

³ Requires Flexi Pipe for connection to soil or mechanical extraction.

⁴ Not suitable for roof pitches below 22.5°.

All dimensions are nominal and taken from the drawing.
Actual product dimensions may vary slightly from those referenced above.

DOUBLE ROMAN

Concrete



A long established Roman design popular in most regions, ideal for both new build and refurbishment.

Product Technical Information Sheet

Roof Tiling	
	17.5° smooth at 100mm headlap
Minimum roof pitch*	22.5° smooth at 75mm headlap 30° sanded at 75mm headlap
Headlap (minimum)	75mm
Headlap (maximum)	120mm
Batten spacing at maximum gauge	345mm
Batten spacing at minimum gauge	300mm
Size of tile	420 x 334mm
Covering capacity	10.5 tiles per m ² at 100mm headlap
	9.7 tiles per m ² at 75mm headlap
Cover width	300mm
Profile depth	50mm
Hanging length	398mm
Weight as laid	44.0 kg per m ² at 100mm headlap
	40.7 kg per m ² at 75mm headlap
Weight per 1000 (including pallet and packaging)	4.3 tonnes
Weight per tile	4.19kg
Weight per pallet (including pallet and packaging)	0.929 tonnes
Bond	Straight
Quantity per pallet	216
Battens per m ²	3.2m at 100mm headlap
	2.9m at 75mm headlap
Batten size - up to 450mm rafter centres	38 x 25mm
Batten size - up to 600mm rafter centres	50 x 25mm
Nail size/type for tiles	65 x 3.75mm aluminium ring shank clout head
Nail size/type for metal tile clips	50 x 3.35mm aluminium ring shank clout head

Unless otherwise stated, data is based on the tiles laid at minimum headlap. Before deciding on the batten gauge and linear coverage, the roof tiler should inspect each batch of tiles to ensure that the correct minimum headlap and sidelap are achieved.

*For projects where the rafters are below 22.5 degrees the roof substructure must be installed in accordance with the Sandtoft low pitch installation guide. Rafter length restrictions apply at minimum roof pitch.

Product specification is subject to change and will be updated accordingly.

Note: Lead times may apply. Colour availability may vary.

** Lead times may apply.

Due to the limitations of the printing process and screen calibration settings images shown may not be an accurate representation of the final product colour. Please obtain a sample if unsure.

Smooth

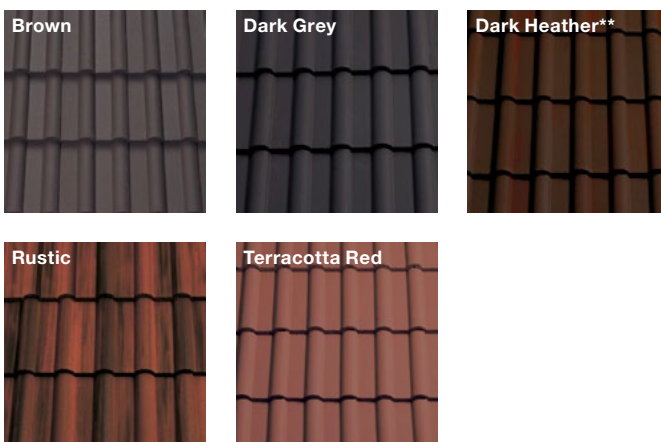

Sanded

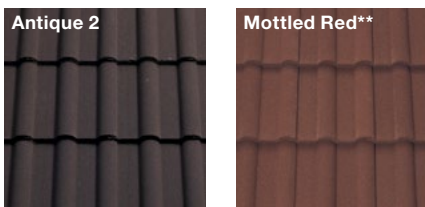

Tile Fixing

Sandtoft roof tiles must be laid and fixed to comply with BS 5534: the British Standard Code of practice for slating and tiling, and BS 8000: Part 6: the British Standard Code of practice for workmanship on building sites. To ensure compliance with these Standards we strongly recommend that a calculated fixing specification be obtained from Sandtoft Technical Support or using Sandtoft's online tool at www.all4roof.co.uk

All4Roof

Fittings

Half Tile

420 x 185 mm



Cloaked Verge

420 x 358 mm



LH and RH available (LH shown)

Accessories

Tile Clip

Nail size 55 x 3.35 mm



Eaves Clip¹

Nail size 20 x 3.35 mm



Verge Clip

Nail size 20 x 3.35 mm



In-Line Vent^{2,4}

420 x 334 x 108 mm



Smoothfaced only

Cowl Vent^{3,4}

420 x 334 mm



Associated Ridge / Hip

Half Round Ridge 457 mm



Segmental Ridge 457 mm



Tile Dimensions

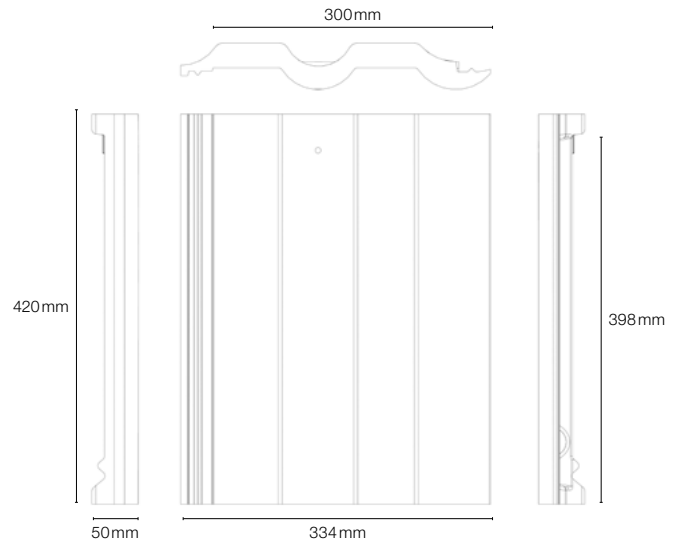

Associated Systems

Dry Ridge/Hip Systems

- HR Roll Ridge Pack 6m CON
- HR Profile Ridge Pack 6m CON⁵
- Seg Roll Hip Pack 6m CON
- HR Profile MonoRidge Pack 6m CON⁵
- Mortarless Hip/Valley Tile Top Clip
- Mortarless Hip/Valley Tail Clip STD
- Profile Dry Ridge Fillers

Dry Verge Systems

- LH Multiverge Unit
- RH Multiverge Unit
- LH Multiverge Eaves Unit
- RH Multiverge Eaves Unit
- Ridge Closure Comb
- Ridge End Cap

Additional Systems

- 10mm Eaves Ventilation Pack
- 25mm Eaves Ventilation Pack
- Top Abutment Ventilator Kit⁵

BIM Object
Download



¹ When used in conjunction with Over Fascia Ventilator Strip, nail length should be increased to 40mm for 10mm Over Fascia Ventilator Strip, or 50mm for 25mm Over Fascia Ventilator Strip.
² Requires Pipe Adaptor & Flexi Pipe for connection to soil or mechanical extraction.
³ Requires Flexi Pipe for connection to soil or mechanical extraction.
⁴ Not suitable for roof pitches below 22.5°.
⁵ Profile Dry Ridge Fillers sold separately in box quantities sufficient for 6m of Ridge/12m of Monoridge.

All dimensions are nominal and taken from the drawing.
 Actual product dimensions may vary slightly from those referenced above.

DOUBLE PANTILE

Concrete



A high quality concrete tile that recreates the flowing lines of a traditional pantile with an inherent strength in its curved design.

Product Technical Information Sheet

Roof Tiling	
Minimum roof pitch*	15° smooth at 100mm headlap 22.5° smooth at 75mm headlap 30° Sanded at 75mm headlap
Headlap (minimum)	75mm
Headlap (maximum)	120mm
Batten spacing at maximum gauge	345mm
Batten spacing at minimum gauge	300mm
Size of tile	420 x 334mm
Covering capacity	10.5 tiles per m ² at 100mm headlap 9.7 tiles per m ² at 75mm headlap
Cover width	300mm
Profile depth	55mm
Hanging length	402mm
Weight as laid	49.6 kg per m ² at 100mm headlap 45.8 kg per m ² at 75mm headlap
Weight per 1000 (including pallet and packaging)	4.87 tonnes
Weight per tile	4.72 kg
Weight per pallet (including pallet and packaging)	1.021 tonnes
Bond	Straight
Quantity per pallet	210
Battens per m ²	3.2m at 100mm headlap 2.9m at 75mm headlap
Batten size - up to 450mm rafter centres	38 x 25mm
Batten size - up to 600mm rafter centres	50 x 25mm
Nail size/type for tiles	65 x 3.75mm aluminium ring shank clout head
Nail size/type for metal tile clips	50 x 3.35mm aluminium ring shank clout head

Unless otherwise stated, data is based on the tiles laid at minimum headlap. Before deciding on the batten gauge and linear coverage, the roof tiler should inspect each batch of tiles to ensure that the correct minimum headlap and sidelap are achieved.

*For projects where the rafters are below 22.5 degrees the roof substructure must be installed in accordance with the Sandtoft low pitch installation guide. Rafter length restrictions apply at minimum roof pitch.

Product specification is subject to change and will be updated accordingly.

Note: Lead times may apply. Colour availability may vary.

Smooth

Brown

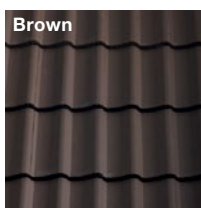

Dark Grey

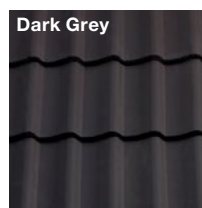

Dark Heather**

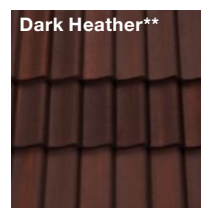

Rustic

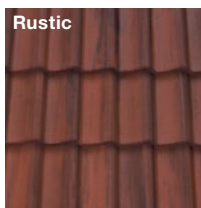

Terracotta Red

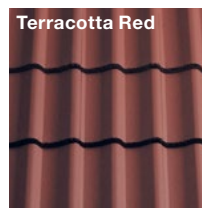

Sanded

Antique 2

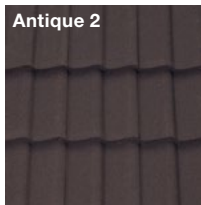

Mottled Red**

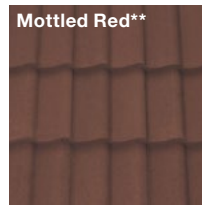

Tile Fixing

Sandtoft roof tiles must be laid and fixed to comply with BS 5534: the British Standard Code of practice for slating and tiling, and BS 8000: Part 6: the British Standard Code of practice for workmanship on building sites. To ensure compliance with these Standards we strongly recommend that a calculated fixing specification be obtained from Sandtoft Technical Support or using Sandtoft's online tool at www.all4roof.co.uk

All4Roof

** Lead times may apply.

Due to the limitations of the printing process and screen calibration settings images shown may not be an accurate representation of the final product colour. Please obtain a sample if unsure.

Fittings

Half Tile

420 x 185 mm



Cloaked Verge

420 x 358 mm



LH and RH available (LH shown)

Accessories

Tile Clip

Nail size 50 x 3.35 mm



Eaves Clip¹

Nail size 20 x 3.35 mm



Verge Clip

Nail size 20 x 3.35 mm



In-Line Vent^{2,4}

420 x 334 x 112 mm



Smoothfaced only

Cowl Vent^{3,4}

420 x 334 mm



Associated Ridge / Hip

Half Round Ridge 457 mm



Segmental Ridge 457 mm



Tile Dimensions

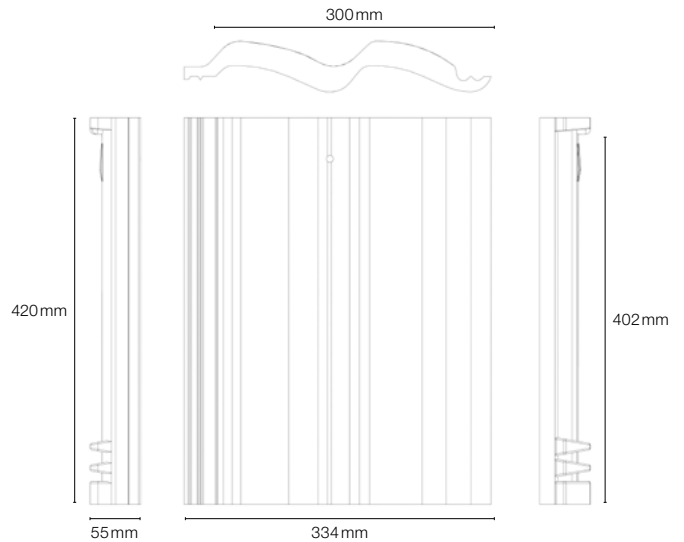

Associated Systems

Dry Ridge/Hip Systems

- HR Roll Ridge Pack 6m CON
- HR Profile Ridge Pack 6m CON⁵
- Seg Roll Hip Pack 6m CON
- HR Profile MonoRidge Pack 6m CON⁵
- Mortarless Hip/Valley Tile Top Clip
- Mortarless Hip/Valley Tail Clip STD
- Profile Dry Ridge Fillers
- Dentil Slip

Dry Verge Systems

- LH Multiverge Unit
- RH Multiverge Unit
- LH Multiverge Eaves Unit
- RH Multiverge Eaves Unit
- Ridge Closure Comb
- Ridge End Cap

Additional Systems

- 10mm Eaves Ventilation Pack
- 25mm Eaves Ventilation Pack
- Top Abutment Ventilator Kit⁵
- Bird Comb Filler

BIM Object
Download



¹ When used in conjunction with Over Fascia Ventilator Strip, nail length should be increased to 40mm for 10mm Over Fascia Ventilator Strip, or 50mm for 25mm Over Fascia Ventilator Strip.

² Requires Pipe Adaptor & Flexi Pipe for connection to soil or mechanical extraction.

³ Requires Flexi Pipe for connection to soil or mechanical extraction.

⁴ Not suitable for roof pitches below 22.5°.

⁵ Profile Dry Ridge Fillers sold separately in box quantities sufficient for 6m of Ridge/12m of Monoridge.

All dimensions are nominal and taken from the drawing. Actual product dimensions may vary slightly from those referenced above.

CLAY

Contents

Humber Plain Tile	36-37
Humber Plain Tile Sandfaced	38-39
Village Plain Tile	40-41
Alban Plain Tile	42-43
Barrow Plain Tile	44-45
301 Plain Tile	46-47
303 Plain Tile	48-49
20/20	50-51
Vauban	52-53
Cassius	54-55
Rivius	56-57
Actua	58-59
Neo Plus	60-61
New County Pantile	62-63
Old English Pantile	64-65
Arcadia Pantile	66-67
451 Old Hollow Pantile	68-69
Olympus Double Pantile	70-71
Modula	72-73
Bridgwater	74-75
Gaelic Single Roman	76-77
Tempest 44 Single Roman	78-79



Kinnedarr Main Farm, Fife
NEO PLUS - NATURAL RED (p60-61)

HUMBER

Plain Tile

Clay



A traditional, cross-cambered, machine made clay plain tile that gives complete design flexibility and is perfect for complex roofs or vertical cladding.

Product Technical Information Sheet

Roof Tiling

Minimum roof pitch	35°
Headlap	65 mm
Batten spacing (fixed gauge) [†]	100 mm
Size of tile [†]	265 x 165 mm
Covering capacity	60 tiles per m ²
Cover width	165 mm
Profile depth	13 mm
Hanging length	245 mm
Weight as laid	63.0 kg per m ²
Weight per 1000 (including pallet and packaging)	1.123 tonnes
Weight per tile	1.05 kg
Weight per pallet (including pallet and packaging)	0.606 tonnes
Bond	Cross / Broken
Quantity per pallet	540
Battens per m ²	10 m
Batten size - up to 600mm rafter centres	38 x 25 mm
Nail size/type for tiles	38 x 3.35 mm aluminium ring shank clout head

Vertical Tiling

Minimum roof pitch	75°
Headlap	38 mm
Batten spacing at (fixed gauge) [†]	114 mm
Size of tile [†]	265 x 165 mm
Covering capacity at max. gauge	53 tiles per m ²
Cover width	165 mm
Profile depth	13 mm
Hanging length	245 mm
Weight as laid	55.7 kg per m ²
Weight per 1000 (including pallet and packaging)	1.123 tonnes
Weight per tile	1.05 kg
Weight per pallet (including pallet and packaging)	0.606 tonnes
Bond	Cross / Broken
Quantity per pallet	540
Battens per m ²	8.8 m
Batten size - up to 600mm rafter centres	38 x 25 mm
Nail size/type for tiles	38 x 3.35 mm aluminium ring shank clout head

[†]Clay tiles are subject to small variations in size because of drying and firing shrinkage in the manufacturing process. Before deciding on the batten gauge and linear coverage, the roof tiler should inspect each batch of tiles to ensure that the correct minimum headlap and sidelap are achieved. Unless otherwise stated, data is based on the tiles laid at minimum headlap.

Product specification is subject to change and will be updated accordingly.

Note: Lead times may apply. Colour availability may vary.

* For use as fitting only.

Due to the limitations of the printing process and screen calibration settings images shown may not be an accurate representation of the final product colour. Please obtain a sample if unsure.

Smooth

Antique Slate*



Flanders

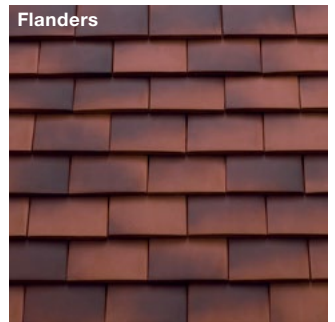

Natural Red

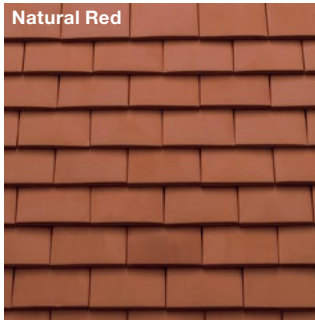

Tuscan

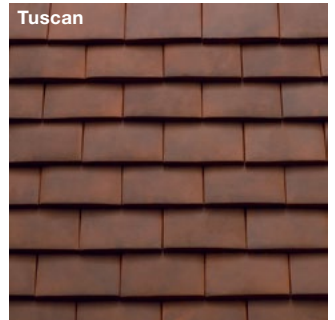

Tile Fixing

Sandtoft roof tiles must be laid and fixed to comply with BS 5534: the British Standard Code of practice for slating and tiling, and BS 8000: Part 6: the British Standard Code of practice for workmanship on building sites. To ensure compliance with these standards we strongly recommend that a calculated fixing specification be obtained from Sandtoft Technical Support or using Sandtoft's online All4Roof tool: www.all4roof.co.uk

All4Roof

Fittings

Eaves/Tops Tile

210 x 165 x 13mm



Tile and a Half

265 x 247 x 13mm



Bonnet Hip

270 x 330 x 13mm



Valley Tile

280 x 350 x 13mm



External Angle°

265 x 160 x 80mm



Feature Tile (Club)

265 x 165 x 13mm



LH and RH available in both 90° and 135°
(LH 90° shown)

Additional Fittings

Arris Hip (35°, 40°, 45°, 50°)

Internal Angle 90° & 135° (LH & RH)

Accessories

InvisiVent¹

490 x 310mm



Associated Ridge / Hip

Half Round Ridge 305mm



Third Round Ridge 305mm

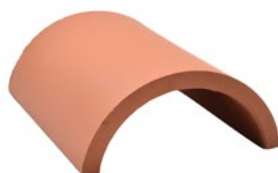

Tile Dimensions

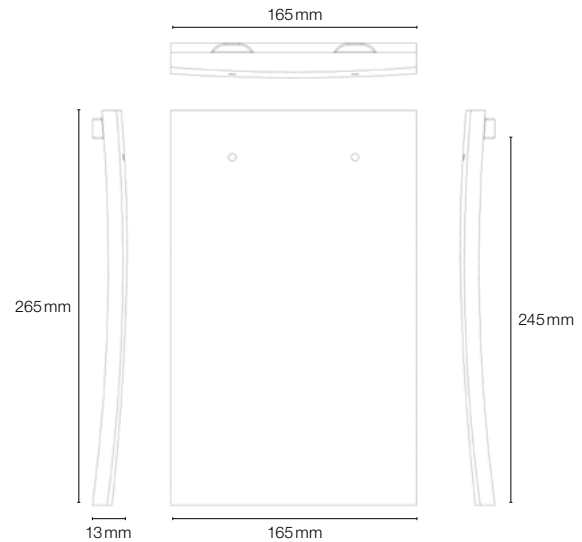

Associated Systems

Ridge/Hip Systems

HR Roll Ridge Pack 6m CLY

HR Profile Ridge Pack 6m CLY

TR Roll Hip Pack 6m CLY

HR Profile MonoRidge Pack 6m CLY

Additional Systems

10mm Eaves Ventilation Pack

25mm Eaves Ventilation Pack

Top Abutment Ventilator Kit

BIM Object
Download



¹ Requires Pipe Adaptor & Flexi Pipe for connection to soil or mechanical extraction.

All dimensions are nominal and taken from the drawing.
Actual product dimensions may vary slightly from those referenced above.

HUMBER SANDFACED

Plain Tile
Clay



Perfectly engineered and designed, the Humber sandfaced clay plain tile is a versatile, flexible option that combines the natural colourfast quality of clay with modern fixture and fitting technology.

Product Technical Information Sheet

Roof Tiling

Minimum roof pitch	35°
Headlap	65 mm
Batten spacing (fixed gauge) [†]	100 mm
Size of tile [†]	265 x 165 mm
Covering capacity	60 tiles per m ²
Cover width	165 mm
Profile depth	13 mm
Hanging length	245 mm
Weight as laid	63.6 kg per m ²
Weight per 1000 (including pallet and packaging)	1.14 tonnes
Weight per tile	1.06 kg
Weight per pallet (including pallet and packaging)	0.602 tonnes
Bond	Cross / Broken
Quantity per pallet	530
Battens per m ²	10 m
Batten size - up to 600mm rafter centres	38 x 25 mm
Nail size/type for tiles	38 x 3.35 mm aluminium ring shank clout head

Vertical Tiling

Minimum roof pitch	75°
Headlap	38 mm
Batten spacing at (fixed gauge) [†]	114 mm
Size of tile [†]	265 x 165 mm
Covering capacity at max. gauge	53 tiles per m ²
Cover width	165 mm
Profile depth	13 mm
Hanging length	245 mm
Weight as laid	56.2 kg per m ²
Weight per 1000 (including pallet and packaging)	1.14 tonnes
Weight per tile	1.06 kg
Weight per pallet (including pallet and packaging)	0.602 tonnes
Bond	Cross / Broken
Quantity per pallet	530
Battens per m ²	8.8 m
Batten size - up to 600mm rafter centres	38 x 25 mm
Nail size/type for tiles	38 x 3.35 mm aluminium ring shank clout head

[†]Clay tiles are subject to small variations in size because of drying and firing shrinkage in the manufacturing process. Before deciding on the batten gauge and linear coverage, the roof tiler should inspect each batch of tiles to ensure that the correct minimum headlap and sidelap are achieved. Unless otherwise stated, data is based on the tiles laid at minimum headlap.

Product specification is subject to change and will be updated accordingly.

Note: Lead times may apply. Colour availability may vary.

Sanded

Buckingham

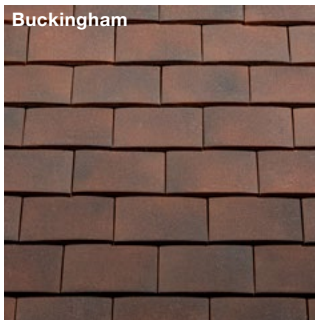

Kensington

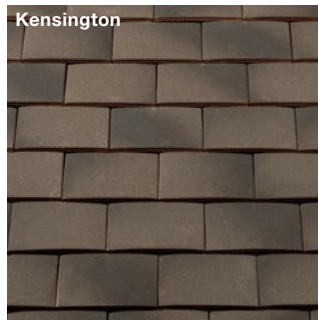

Tile Fixing

Sandtoft roof tiles must be laid and fixed to comply with BS 5534: the British Standard Code of practice for slating and tiling, and BS 8000: Part 6: the British Standard Code of practice for workmanship on building sites. To ensure compliance with these standards we strongly recommend that a calculated fixing specification be obtained from Sandtoft Technical Support or using Sandtoft's online All4Roof tool: www.all4roof.co.uk

All4Roof

HUMBER SANDFACED

Plain Tile
Clay

Fittings

Eaves/Tops Tile

210 x 165 x 13mm



Tile and a Half

265 x 247 x 13mm



Bonnet Hip

270 x 330 x 13mm



Valley Tile

280 x 350 x 13mm



External Angle

265 x 160 x 80mm



Feature Tile (Club)

265 x 165 x 13mm



LH and RH available in both 90° and 135°
(LH 90° shown)

Additional Fittings

Arris Hip (35°, 40°, 45°, 50°)

Internal Angle 90° & 135° (LH & RH)

Accessories

InvisiVent¹

490 x 310mm



Associated Ridge / Hip

Half Round Ridge 305mm



Third Round Ridge 305mm



Tile Dimensions

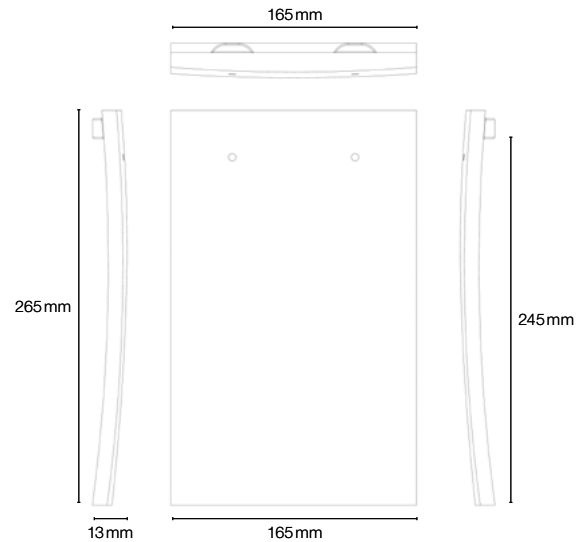

Associated Systems

Ridge/Hip Systems

HR Profile Ridge Pack 6m CLY

HR Profile MonoRidge Pack 6m CLY

Additional Systems

10mm Eaves Ventilation Pack

25mm Eaves Ventilation Pack

Top Abutment Ventilator Kit

BIM Object
Download



¹ Requires Pipe Adaptor & Flexi Pipe for connection to soil or mechanical extraction.

All dimensions are nominal and taken from the drawing.
Actual product dimensions may vary slightly from those referenced above.

VILLAGE

Plain Tile

Clay



The Village plain tile is perfect for use on porches and dormers as an accompaniment to our Arcadia Pantile.

Product Technical Information Sheet

Roof Tiling

Minimum roof pitch	35°
Headlap	65 mm
Batten spacing (fixed gauge) [†]	100 mm
Size of tile [†]	265 x 165 mm
Covering capacity	60 tiles per m ²
Cover width	165 mm
Profile depth	13 mm
Hanging length	245 mm
Weight as laid	63.0 kg per m ²
Weight per 1000 (including pallet and packaging)	1.123 tonnes
Weight per tile	1.05 kg
Weight per pallet (including pallet and packaging)	0.606 tonnes
Bond	Cross / Broken
Quantity per pallet	540
Battens per m ²	10 m
Batten size - up to 600mm rafter centres	38 x 25 mm
Nail size/type for tiles	38 x 3.35 mm aluminium ring shank clout head

Vertical Tiling

Minimum roof pitch	75°
Headlap	38 mm
Batten spacing at (fixed gauge) [†]	114 mm
Size of tile [†]	265 x 165 mm
Covering capacity at max. gauge	53 tiles per m ²
Cover width	165 mm
Profile depth	13 mm
Hanging length	245 mm
Weight as laid	55.7 kg per m ²
Weight per 1000 (including pallet and packaging)	1.123 tonnes
Weight per tile	1.05 kg
Weight per pallet (including pallet and packaging)	0.606 tonnes
Bond	Cross / Broken
Quantity per pallet	540
Battens per m ²	8.8 m
Batten size - up to 600mm rafter centres	38 x 25 mm
Nail size/type for tiles	38 x 3.35 mm aluminium ring shank clout head

[†]Clay tiles are subject to small variations in size because of drying and firing shrinkage in the manufacturing process. Before deciding on the batten gauge and linear coverage, the roof tiler should inspect each batch of tiles to ensure that the correct minimum headlap and sidelap are achieved. Unless otherwise stated, data is based on the tiles laid at minimum headlap.

Product specification is subject to change and will be updated accordingly.

Note: Lead times may apply. Colour availability may vary.

* For use as fitting only.

Due to the limitations of the printing process and screen calibration settings images shown may not be an accurate representation of the final product colour. Please obtain a sample if unsure.

Weathered

Reclaimed*



Tile Fixing

Sandtoft roof tiles must be laid and fixed to comply with BS 5534: the British Standard Code of practice for slating and tiling, and BS 8000: Part 6: the British Standard Code of practice for workmanship on building sites. To ensure compliance with these standards we strongly recommend that a calculated fixing specification be obtained from Sandtoft Technical Support or using Sandtoft's online All4Roof tool: www.all4roof.co.uk

All4Roof

Fittings

Eaves/Tops Tile

210 x 165 x 13mm



Tile and a Half

265 x 247 x 13mm



Bonnet Hip

270 x 330 x 13mm



Valley Tile

280 x 350 x 13mm



External Angle

265 x 160 x 80mm



Feature Tile (Club)

265 x 165 x 13mm



LH and RH available in both 90° and 135° (LH 90° shown)

Additional Fittings

Arris Hip (35°, 40°, 45°, 50°)

Internal Angle 90° & 135° (LH & RH)

Accessories

InvisiVent¹

490 x 310mm



Associated Ridge / Hip

Half Round Ridge 305mm



Third Round Ridge 305mm



Tile Dimensions

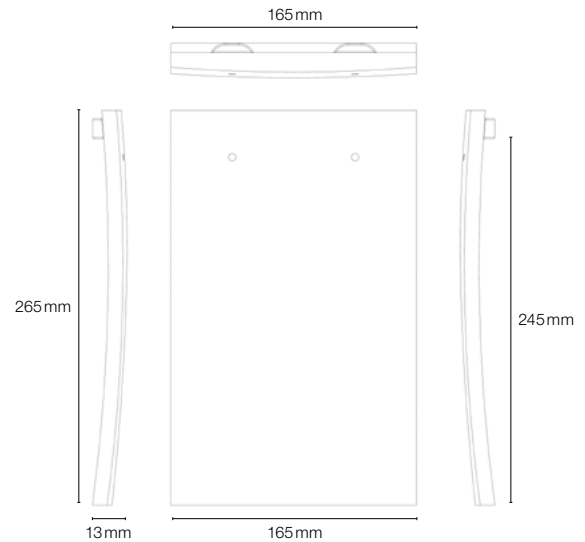

Associated Systems

Ridge/Hip Systems

HR Roll Ridge Pack 6m CLY

HR Profile Ridge Pack 6m CLY

TR Roll Hip Pack 6m CLY

HR Profile MonoRidge Pack 6m CLY

Additional Systems

10mm Eaves Ventilation Pack

25mm Eaves Ventilation Pack

Top Abutment Ventilator Kit

BIM Object
Download



¹ Requires Pipe Adaptor & Flexi Pipe for connection to soil or mechanical extraction.

All dimensions are nominal and taken from the drawing. Actual product dimensions may vary slightly from those referenced above.

ALBAN

Plain Tile

Clay



With its sanded texture, irregular form and rustic tones, the Alban plain tile adds charm and character to any roof.

Product Technical Information Sheet

Roof Tiling

Minimum roof pitch	35°
Headlap	65 mm
Batten spacing (fixed gauge) [†]	100 mm
Size of tile [†]	265 x 165 mm
Covering capacity	60 tiles per m ²
Cover width	165 mm
Profile depth	13 mm
Hanging length	245 mm
Weight as laid	60.6 kg per m ²
Weight per 1000 (including pallet and packaging)	1.1 tonnes
Weight per tile	1.01 kg
Weight per pallet (including pallet and packaging)	0.583 tonnes
Bond	Cross / Broken
Quantity per pallet	530
Battens per m ²	10 m
Batten size - up to 600mm rafter centres	38 x 25 mm
Nail size/type for tiles	38 x 3.35 mm aluminium ring shank clout head

Vertical Tiling

Minimum roof pitch	75°
Headlap	38 mm
Batten spacing (fixed gauge) [†]	114 mm
Size of tile [†]	265 x 165 mm
Covering capacity	53 tiles per m ²
Cover width	165 mm
Profile depth	13 mm
Hanging length	245 mm
Weight as laid	53.6 kg per m ²
Weight per 1000 (including pallet and packaging)	1.1 tonnes
Weight per tile	1.01 kg
Weight per pallet (including pallet and packaging)	0.583 tonnes
Bond	Cross / Broken
Quantity per pallet	530
Battens per m ²	8.8 m
Batten size - up to 600mm rafter centres	38 x 25 mm
Nail size/type for tiles	38 x 3.35 mm aluminium ring shank clout head

[†]Clay tiles are subject to small variations in size because of drying and firing shrinkage in the manufacturing process. Before deciding on the batten gauge and linear coverage, the roof tiler should inspect each batch of tiles to ensure that the correct minimum headlap and sidelap are achieved. Unless otherwise stated, data is based on the tiles laid at minimum headlap.

Product specification is subject to change and will be updated accordingly.

Note: Lead times may apply. Colour availability may vary.

Sanded

Sussex Blend



Tile Fixing

Sandtoft roof tiles must be laid and fixed to comply with BS 5534: the British Standard Code of practice for slating and tiling, and BS 8000: Part 6: the British Standard Code of practice for workmanship on building sites. To ensure compliance with these Standards we strongly recommend that a calculated fixing specification be obtained from Sandtoft Technical Support or using Sandtoft's online tool at www.all4roof.co.uk

All4Roof

Fittings

Eaves Tile

210 x 165 x 13mm



Tile and a Half

265 x 247 x 13mm



Bonnet Hip

270 x 330 x 13mm



Valley Tile

280 x 350 x 13mm



External Angle

265 x 160 x 80mm



Feature Tile (Club)

265 x 165 x 13mm



LH and RH available in both 90° and 135°
(LH 90° shown)

Additional Fittings

Arris Hip (35°, 40°, 45°, 50°)

Internal Angle 90° & 135° (LH & RH)

Accessories

InvisiVent¹

490 x 310mm



Associated Ridge / Hip

Half Round Ridge 305mm



Third Round Ridge 305mm



¹ Requires Pipe Adaptor & Flexi Pipe for connection to soil or mechanical extraction.
All dimensions are nominal and taken from the drawing.
Actual product dimensions may vary slightly from those referenced above.

Tile Dimensions

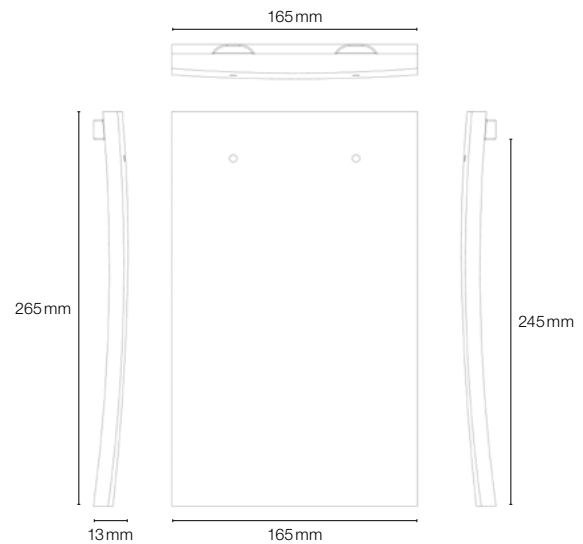

Associated Systems

Ridge/Hip Systems

HR Profile Ridge Pack 6m CLY

HR Profile MonoRidge Pack 6m CLY

Additional Systems

10mm Eaves Ventilation Pack

25mm Eaves Ventilation Pack

Top Abutment Ventilator Kit

BIM Object
Download



BARROW

Plain Tile

Clay



A handcrafted clay plain tile with a sanded finish. Each tile has a subtle irregular form which creates the appearance of a traditional, aged roof with character.

Product Technical Information Sheet

Roof Tiling

Minimum roof pitch	35°
Headlap	65 mm
Batten spacing (fixed gauge) [†]	100 mm
Size of tile [†]	265 x 165 mm
Covering capacity at max. gauge	60 tiles per m ²
Cover width	165 mm
Profile depth	13 mm
Hanging length	245 mm
Weight as laid	61.8 kg per m ²
Weight per 1000 (including pallet and packaging)	1.1 tonnes
Weight per tile	1.03 kg
Weight per pallet (including pallet and packaging)	0.583 tonnes
Bond	Cross / Broken
Quantity per pallet	530
Battens per m ²	10 m
Batten size - up to 600mm rafter centres	38 x 25 mm
Nail size/type for tiles	38 x 3.35 mm aluminium ring shank clout head

Vertical Tiling

Minimum roof pitch	75°
Headlap (minimum)	38 mm
Batten spacing at max. gauge [†]	114 mm
Size of tile [†]	265 x 165 mm
Covering capacity at max. gauge	53 tiles per m ²
Cover width	165 mm
Profile depth	13 mm
Hanging length	245 mm
Weight as laid	54.6 kg per m ²
Weight per 1000 (including pallet and packaging)	1.1 tonnes
Weight per tile	1.03 kg
Weight per pallet (including pallet and packaging)	0.583 tonnes
Bond	Cross / Broken
Quantity per pallet	530
Battens per m ²	8.8 m
Batten size - up to 600mm rafter centres	38 x 25 mm
Nail size/type for tiles	38 x 3.35 mm aluminium ring shank clout head

[†]Clay tiles are subject to small variations in size because of drying and firing shrinkage in the manufacturing process. Before deciding on the batten gauge and linear coverage, the roof tiler should inspect each batch of tiles to ensure that the correct minimum headlap and sidelap are achieved. Unless otherwise stated, data is based on the tiles laid at minimum headlap.

Product specification is subject to change and will be updated accordingly.

Note: Lead times may apply. Colour availability may vary.

Sanded

Bay Brown

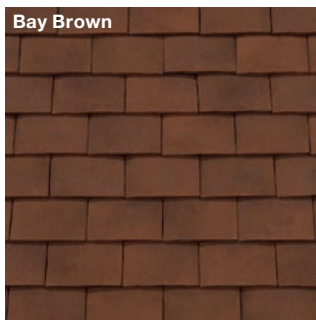

Burnt Oak

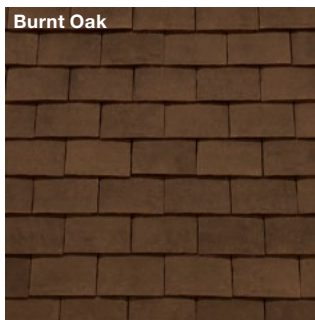

Dark Rusper

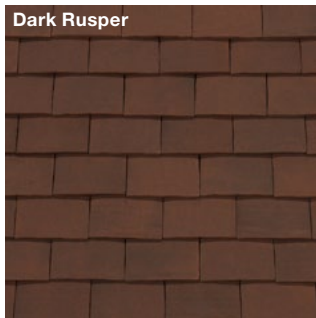

Light Rusper



Tile Fixing

Sandtoft roof tiles must be laid and fixed to comply with BS 5534: the British Standard Code of practice for slating and tiling, and BS 8000: Part 6: the British Standard Code of practice for workmanship on building sites. To ensure compliance with these standards we strongly recommend that a calculated fixing specification be obtained from Sandtoft Technical Support or using Sandtoft's online All4Roof tool: www.all4roof.co.uk

All4Roof

Fittings

Eaves/Tops Tile

210 x 165 x 13mm



Tile and a Half

265 x 247 x 13mm



Bonnet Hip

270 x 330 x 13mm



Valley Tile

280 x 350 x 13mm



External Angle

265 x 160 x 80mm



Feature Tile (Club)

265 x 165 x 13mm



LH and RH available in both 90° and 135°
(LH 90° shown)

Additional Fittings

Arris Hip (35°, 40°, 45°, 50°)

Internal Angle 90° & 135° (LH & RH)

Accessories

InvisiVent¹

490 x 310mm



Associated Ridge / Hip

Half Round Ridge 305mm



Third Round Ridge 305mm



¹ Requires Pipe Adaptor & Flexi Pipe for connection to soil or mechanical extraction.

All dimensions are nominal and taken from the drawing.
Actual product dimensions may vary slightly from those referenced above.

Tile Dimensions

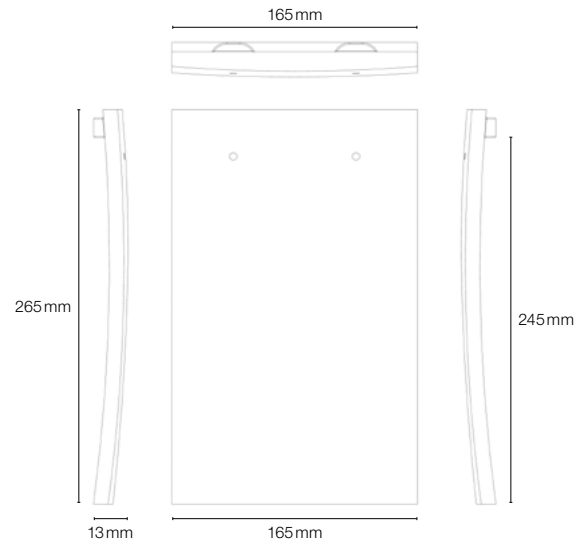

Associated Systems

Additional Systems

10mm Eaves Ventilation Pack

25mm Eaves Ventilation Pack

Top Abutment Ventilator Kit

BIM Object
Download



301

Plain Tile

Clay



A traditional clay plain tile that gives complete design flexibility, perfect for adding character to any roof and wall.

Product Technical Information Sheet

Roof Tiling

Minimum roof pitch	35°
Headlap	65 mm
Batten spacing (fixed gauge) [†]	102.5 mm
Size of tile [†]	270 x 170 mm
Covering capacity	57.4 tiles per m ²
Cover width	170 mm
Profile depth	12 mm
Hanging length	254 mm
Weight as laid	58.6 kg per m ²
Weight per 1000 (including pallet and packaging)	1.06 tonnes
Weight per tile	1.02 kg
Weight per pallet (including pallet and packaging)	1.221 tonnes
Bond	Cross / Broken
Quantity per pallet	1152
Battens per m ²	9.8 m
Batten size - up to 600mm rafter centres	38 x 25 mm
Nail size/type for tiles	38 x 3.35 mm aluminium ring shank clout head

Vertical Tiling

Minimum roof pitch	75°
Headlap	38 mm
Batten spacing (fixed gauge) [†]	116 mm
Size of tile [†]	270 x 170 mm
Covering capacity	50.8 tiles per m ²
Cover width	170 mm
Profile depth	12 mm
Hanging length	254 mm
Weight as laid	51.9 kg per m ²
Weight per 1000 (including pallet and packaging)	1.06 tonnes
Weight per tile	1.02 kg
Weight per pallet (including pallet and packaging)	1.221 tonnes
Bond	Cross / Broken
Quantity per pallet	1152
Battens per m ²	8.7 m
Batten size - up to 600mm rafter centres	38 x 25 mm
Nail size/type for tiles	38 x 3.35 mm aluminium ring shank clout head

[†]Clay tiles are subject to small variations in size because of drying and firing shrinkage in the manufacturing process. Before deciding on the batten gauge and linear coverage, the roof tiler should inspect each batch of tiles to ensure that the correct minimum headlap and sidelap are achieved. Unless otherwise stated, data is based on the tiles laid at minimum headlap.

Product specification is subject to change and will be updated accordingly.

Note: Lead times may apply. Colour availability may vary.

Smooth

Amarant

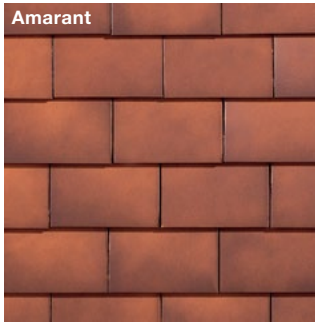

Natural Red



Rustic

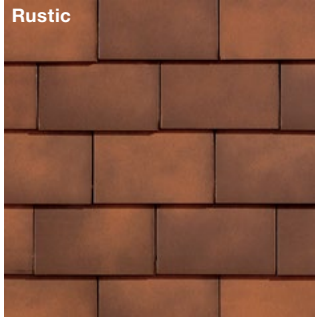

Toscana



Tile Fixing

Sandtoft roof tiles must be laid and fixed to comply with BS 5534: the British Standard Code of practice for slating and tiling, and BS 8000: Part 6: the British Standard Code of practice for workmanship on building sites. To ensure compliance with these Standards we strongly recommend that a calculated fixing specification be obtained from Sandtoft Technical Support or using Sandtoft's online tool at www.all4roof.co.uk

All4Roof

Fittings

Eaves / Tops Tile

185 x 170 x 12 mm



Tile and a Half

270 x 255 x 12 mm



Bonnet Hip

300 x 335 x 12 mm



Valley Tile

290 x 325 x 12 mm



External Angle 90°

270 x 180 x 55 mm



Feature Tile (Club)

270 x 170 x 12 mm



LH and RH available (LH shown)

Lead times may apply

Accessories

InvisiVent^{1 2}

490 x 310 mm

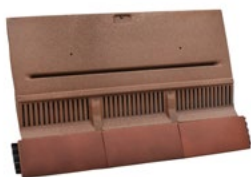

Associated Ridge / Hip

Koramic 325mm Ridge



Tile Dimensions

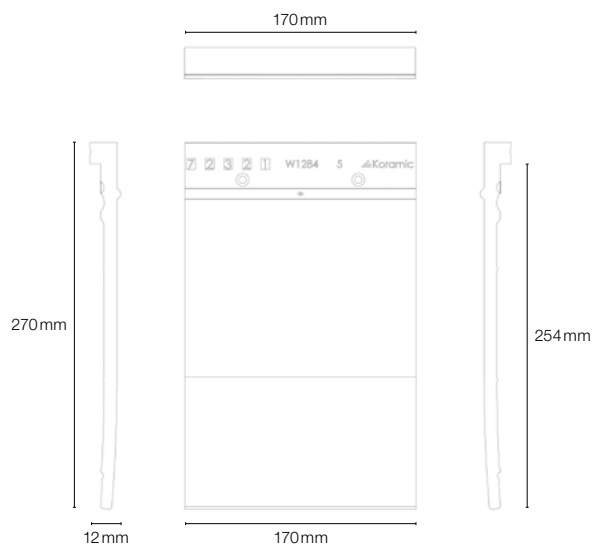

Associated Systems

Additional Systems

- 10mm Eaves Ventilation Pack
- 25mm Eaves Ventilation Pack
- Top Abutment Ventilator Kit

BIM Object
Download



¹ Requires Pipe Adaptor & Flexi Pipe for connection to soil or mechanical extraction.

² Not suitable for roof pitches below 22.5°.

All dimensions are nominal and taken from the drawing.
Actual product dimensions may vary slightly from those referenced above.

303

Plain Tile

Clay



A traditional clay plain tile with a sanded finish, available in a choice of three colours.

Product Technical Information Sheet

Roof Tiling

Minimum roof pitch	35°
Headlap	65 mm
Batten spacing (fixed gauge) [†]	102.5 mm
Size of tile [†]	270 x 170 mm
Covering capacity	57.4 tiles per m ²
Cover width	170 mm
Profile depth	12 mm
Hanging length	254 mm
Weight as laid	60.9 kg per m ²
Weight per 1000 (including pallet and packaging)	1.07 tonnes
Weight per tile	1.06 kg
Weight per pallet (including pallet and packaging)	1.233 tonnes
Bond	Cross / Broken
Quantity per pallet	1152
Battens per m ²	9.8 m
Batten size - up to 600mm rafter centres	38 x 25 mm
Nail size/type for tiles	38 x 3.35 mm aluminium ring shank clout head

Vertical Tiling

Minimum roof pitch	75°
Headlap	38 mm
Batten spacing (fixed gauge) [†]	116 mm
Size of tile [†]	270 x 170 mm
Covering capacity	50.8 tiles per m ²
Cover width	170 mm
Profile depth	12 mm
Hanging length	254 mm
Weight as laid	53.9 kg per m ²
Weight per 1000 (including pallet and packaging)	1.07 tonnes
Weight per tile	1.06 kg
Weight per pallet (including pallet and packaging)	1.233 tonnes
Bond	Cross / Broken
Quantity per pallet	1152
Battens per m ²	8.7 m
Batten size - up to 600mm rafter centres	38 x 25 mm
Nail size/type for tiles	38 x 3.35 mm aluminium ring shank clout head

[†]Clay tiles are subject to small variations in size because of drying and firing shrinkage in the manufacturing process. Before deciding on the batten gauge and linear coverage, the roof tiler should inspect each batch of tiles to ensure that the correct minimum headlap and sidelap are achieved. Unless otherwise stated, data is based on the tiles laid at minimum headlap.

Product specification is subject to change and will be updated accordingly.

Note: Lead times may apply. Colour availability may vary.

Sanded

Old Heather

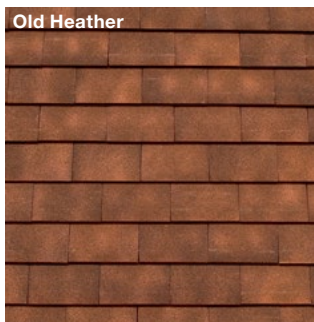

Old Rustic

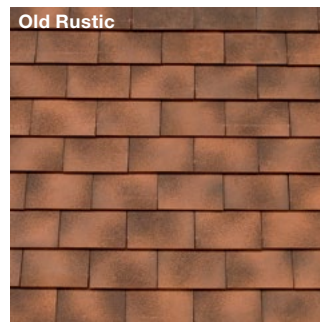

Old Weathered



Tile Fixing

Sandtoft roof tiles must be laid and fixed to comply with BS 5534: the British Standard Code of practice for slating and tiling, and BS 8000: Part 6: the British Standard Code of practice for workmanship on building sites. To ensure compliance with these Standards we strongly recommend that a calculated fixing specification be obtained from Sandtoft Technical Support or using Sandtoft's online tool at www.all4roof.co.uk

All4Roof

Fittings

Eaves / Tops Tile

185 x 170 x 12 mm



Tile and a Half

270 x 255 x 12 mm



Bonnet Hip

300 x 335 x 12 mm



Valley Tile

290 x 325 x 12 mm



External Angle 90

270 x 180 x 55 mm



Feature Tile Club

270 x 170 x 12 mm



LH and RH available (LH shown)

Lead times may apply

Accessories

InvisiVent^{1 2}

490 x 310 mm



Associated Ridge / Hip

Koramic 325mm Ridge



Tile Dimensions

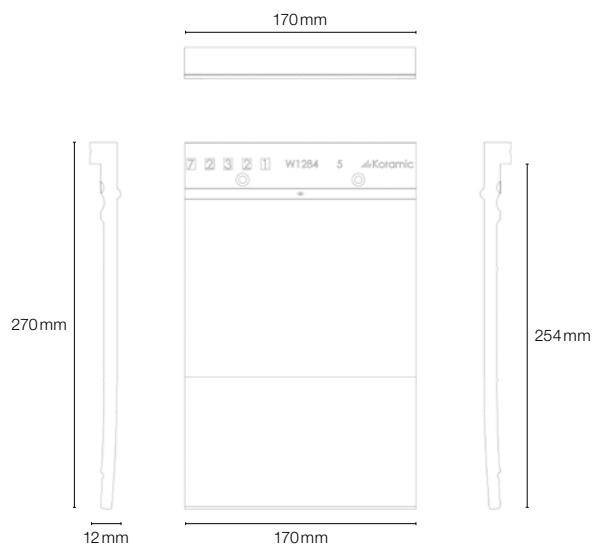

Associated Systems

Additional Systems

- 10mm Eaves Ventilation Pack
- 25mm Eaves Ventilation Pack
- Top Abutment Ventilator Kit

BIM Object
Download



¹ Requires Pipe Adaptor & Flexi Pipe for connection to soil or mechanical extraction.

² Not suitable for roof pitches below 22.5°.

All dimensions are nominal and taken from the drawing.
Actual product dimensions may vary slightly from those referenced above.

20/20

Clay



A new generation interlocking clay plain tile. The 20/20 makes a plain tile roof more affordable through an innovative design that reduces labour and material costs, and cuts completion times.

Product Technical Information Sheet

Roof Tiling	
Minimum roof pitch*	15° at 100mm headlap 22.5° at 75mm headlap
Headlap (minimum)	75 mm
Headlap (maximum)	120 mm
Batten spacing at maximum gauge†	225 mm
Batten spacing at minimum gauge†	210 mm
Size of tile†	330 x 226 mm
Covering capacity	23.2 tiles per m ² at 100mm headlap
	20.9 tiles per m ² at 75 mm headlap
Cover width	188 mm
Profile depth	16 mm
Hanging length	300 mm
Weight as laid	43.9 kg per m ² at 100mm headlap
	49.6 kg per m ² at 75 mm headlap
Weight per 1000 (including pallet and packaging)	1.992 tonnes
Weight per tile	1.89 kg
Weight per pallet (including pallet and packaging)	956 kg
Bond	Cross / Broken
Quantity per pallet	480
Quantity per row/band	40
Quantity per mini pack	10
Quantity per layer	120
Mini packs per row	4
Battens per m ²	4.4 m at 100 mm headlap
	4.0 m at 75 mm headlap
Batten size - up to 450 mm rafter centres	38 x 25 mm
Batten size - up to 600 mm rafter centres	50 x 25 mm
Nail size/type for tiles	45 x 3.35 mm aluminium ring shank clout head
Nail size/type for metal tile clips	55 x 3.35 mm aluminium ring shank clout head

*For projects where the rafters are below 22.5 degrees the roof substructure must be installed in accordance with the Sandtoft low pitch installation guide. Rafter length restrictions apply at minimum roof pitch.

†Clay tiles are subject to small variations in size because of drying and firing shrinkage in the manufacturing process. Before deciding on the batten gauge and linear coverage, the roof tiler should inspect each batch of tiles to ensure that the correct minimum headlap and sidelap are achieved. Unless otherwise stated, data is based on the tiles laid at minimum headlap.

Product specification is subject to change and will be updated accordingly.

Note: Lead times may apply. Colour availability may vary.

Smooth

Antique Slate

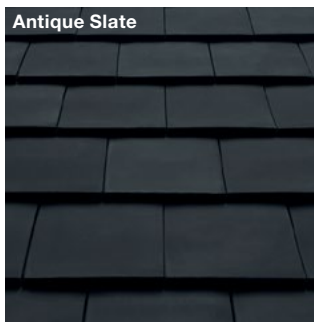

Flanders

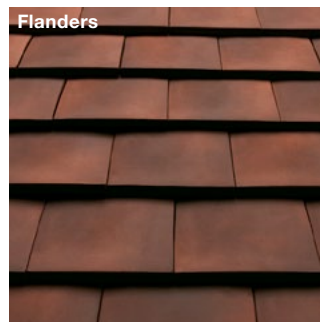

Natural Red



Tuscan

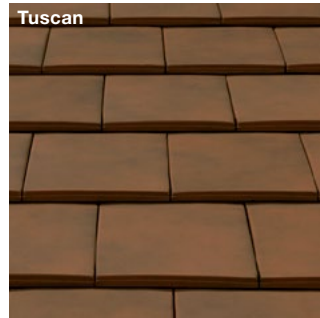

Tile Fixing

Sandtoft roof tiles must be laid and fixed to comply with BS 5534: the British Standard Code of practice for slating and tiling, and BS 8000: Part 6: the British Standard Code of practice for workmanship on building sites. To ensure compliance with these Standards we strongly recommend that a calculated fixing specification be obtained from Sandtoft Technical Support or using Sandtoft's online tool at www.all4roof.co.uk

All4Roof

Fittings

Left Hand Verge

330 x 191 x 16mm



Tile and a Half Left Hand

330 x 286 x 16mm



Tile and a Half Right Hand

330 x 321 x 16mm



Accessories

Tile Clip

Nail size 55 x 3.35mm



Eaves Clip¹

Nail size 20 x 3.35mm



Verge Clip

Nail size 20 x 3.35mm



In-Line Vent^{2,3}

470 x 401 x 140mm



Associated Ridge / Hip

Half Round Duracoat® Ridge 457mm



Segmental Duracoat® Ridge 457mm



Tile Dimensions

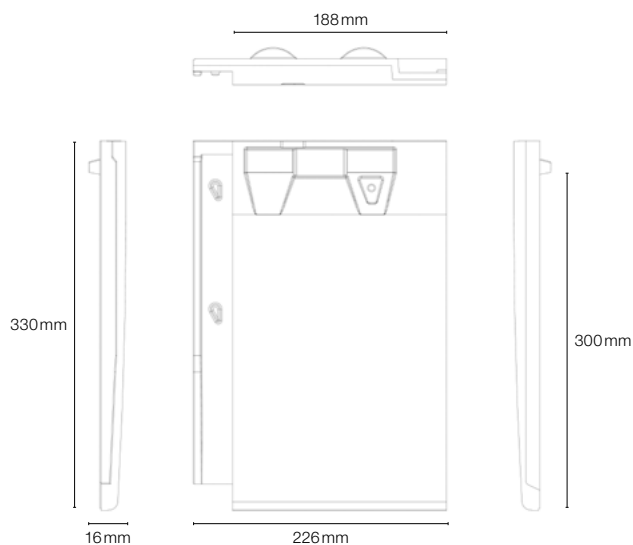

Associated Systems

Ridge/Hip Systems

HR Roll Ridge Pack 6m CON
 HR Profile Ridge Pack 6m CON
 Seg Roll Hip Pack 6m CON
 HR Profile MonoRidge Pack 6m CON
 Mortarless Hip/Valley Tile Top Clip
 Mortarless Hip/Valley Tail Clip TLE

Dry Verge Systems

LH TLE/MF Dry Verge Unit
 RH TLE/MF Dry Verge Unit
 LH TLE/MF Dry Verge Eaves Unit
 RH TLE/MF Dry Verge Eaves Unit
 Ridge Closure Comb
 Ridge End Cap

Additional Systems

10mm Eaves Ventilation Pack
 25mm Eaves Ventilation Pack
 Top Abutment Ventilator Kit

BIM Object
Download



¹ When used in conjunction with Over Fascia Ventilator Strip, nail length should be increased to 40mm for 10mm Over Fascia Ventilator Strip, or 50mm for 25mm Over Fascia Ventilator Strip.

² Requires Flexi Pipe for connection to soil or mechanical extraction.

³ Not suitable for roof pitches below 22.5°. Low pitch In-Line Vent w/Pipe Adaptor also available for pitches below 22.5°

All dimensions are nominal and taken from the drawing.

Actual product dimensions may vary slightly from those referenced above.

VAUBAN

Clay



The Vauban is a medium format interlocking clay tile that gives a clean contemporary look, and can perform down to pitches as low as 22.5°.

Product Technical Information Sheet

Roof Tiling	
Minimum roof pitch	22.5°
Headlap (minimum)	93 mm
Headlap (maximum)	108 mm
Batten spacing at maximum gauge†	273 mm
Batten spacing at minimum gauge†	258 mm
Size of tile†	366 x 202 mm
Covering capacity	21.9 tiles per m ² at 75 mm headlap
Cover width	168 mm
Profile depth	20 mm
Hanging length	326 mm
Weight as laid	51.5 kg per m ² at 75 mm headlap
Weight per 1000 (including pallet and packaging)	2.26 tonnes
Weight per tile	2.35 kg
Weight per pallet (including pallet and packaging)	0.826 tonnes
Bond	Cross / Broken
Quantity per pallet	350
Battens per m ²	3.7 m
Batten size - up to 450 mm rafter centres	38 x 25 mm
Batten size - up to 600 mm rafter centres	50 x 25 mm
Nail size/type for tiles	50 x 3.35 mm aluminium ring shank clout head
Nail size/type for metal tile clips	55 x 3.35 mm aluminium ring shank clout head

†Clay tiles are subject to small variations in size because of drying and firing shrinkage in the manufacturing process. Before deciding on the batten gauge and linear coverage, the roof tiler should inspect each batch of tiles to ensure that the correct minimum headlap and sidelap are achieved. Unless otherwise stated, data is based on the tiles laid at minimum headlap.

Product specification is subject to change and will be updated accordingly.

Note: Lead times may apply. Colour availability may vary.

Smooth

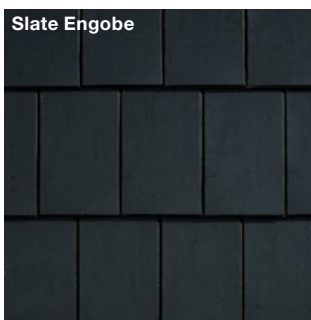
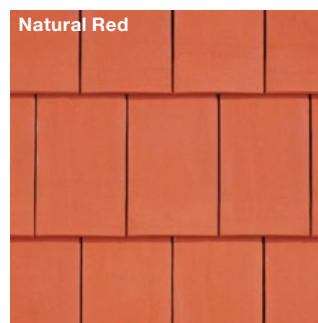
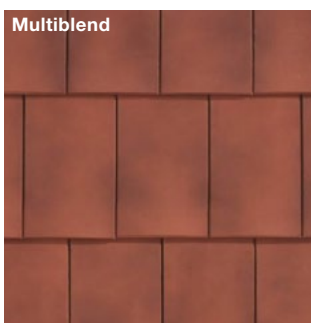

Tile Fixing

Sandtoft roof tiles must be laid and fixed to comply with BS 5534: the British Standard Code of practice for slating and tiling, and BS 8000: Part 6: the British Standard Code of practice for workmanship on building sites. To ensure compliance with these standards we strongly recommend that a calculated fixing specification be obtained from Sandtoft Technical Support or using Sandtoft's online All4Roof tool: www.all4roof.co.uk



Fittings

Eaves Tile

366 x 202 x 30mm



Left Hand Vergé

366 x 168 x 30mm



Tile and a Half Left Hand

366 x 252 x 30mm



Tile and a Half Right Hand

366 x 295 x 30mm



Accessories

Tile Clip

Nail size 50 x 3.35mm



Eaves Clip¹

Nail size 20 x 3.35mm



Vergé Clip

Nail size 20 x 3.35mm



In-Line Vent^{2,3}

457 x 370 x 131mm



Associated Ridge / Hip

Half Round Duracoat® Ridge 457mm



Segmental Duracoat® Ridge 457mm



Tile Dimensions

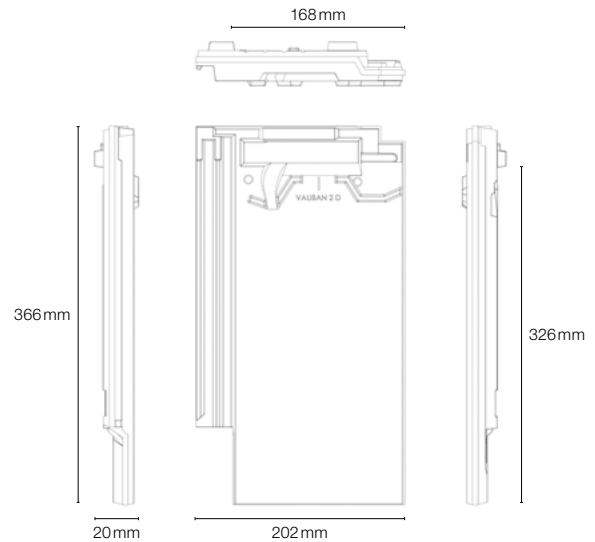

Associated Systems

Ridge/Hip Systems

HR Roll Ridge Pack 6m CON
HR Profile Ridge Pack 6m CON
Seg Roll Hip Pack 6m CON
HR Profile MonoRidge Pack 6m CON
Mortarless Hip/Valley Tile Top Clip
Mortarless Hip/Valley Tail Clip STD

Dry Vergé Systems

Continuous Dry Vergé
Vergé Connector
Eaves Stop End

Additional Systems

10mm Eaves Ventilation Pack
25mm Eaves Ventilation Pack
Top Abutment Ventilator Kit

BIM Object
Download



¹ When used in conjunction with Over Fascia Ventilator Strip, nail length should be increased to 40mm for 10mm

Over Fascia Ventilator Strip, or 50mm for 25mm Over Fascia Ventilator Strip.

² Requires Flexi Pipe for connection to soil or mechanical extraction.

³ Not suitable for roof pitches below 22.5°.

All dimensions are nominal and taken from the drawing.

Actual product dimensions may vary slightly from those referenced above.

CASSIUS

Clay



Cassius is a thin leading edge large format tile that creates an attractive natural clay roof, while the large format size and interlocking design reduce material and installation costs.

Product Technical Information Sheet

Roof Tiling

Minimum roof pitch	22.5°
Headlap (minimum)	75 mm
Headlap (maximum)	120 mm
Batten spacing at maximum gauge †	343 mm
Batten spacing at minimum gauge †	298 mm
Size of tile*	418 x 335 mm
Covering capacity	9.5 tiles per m ² at 75 mm headlap
Cover width	307 mm
Profile depth	16 mm
Hanging length	390 mm
Weight as laid	38.5 kg per m ²
Weight per 1000 (including pallet and packaging)	4.19 tonnes
Weight per tile	4.05 kg
Weight per pallet (including pallet and packaging)	1.004 tonnes
Bond	Cross / Broken
Quantity per pallet	240
Quantity per row/band	40
Quantity per mini pack	5
Quantity per layer	120
Mini packs per row	8
Battens per m ²	3.0m at 75 mm headlap
Batten size - up to 450 mm rafter centres	38 x 25 mm
Batten size - up to 600 mm rafter centres	50 x 25 mm
Nail size/type for tiles	45 x 3.35 mm aluminium ring shank clout head
Nail size/type for metal tile clips	55 x 3.35 mm aluminium ring shank clout head

† Clay tiles are subject to small variations in size because of drying and firing shrinkage in the manufacturing process. Before deciding on the batten gauge and linear coverage, the roof tiler should inspect each batch of tiles to ensure that the correct minimum headlap and sidelap are achieved. Unless otherwise stated, data is based on the tiles laid at minimum headlap.

Product specification is subject to change and will be updated accordingly.

Note: Lead times may apply. Colour availability may vary.

Smooth

Antique Slate



Tile Fixing

Sandtoft roof tiles must be laid and fixed to comply with BS 5534: the British Standard Code of practice for slating and tiling, and BS 8000: Part 6: the British Standard Code of practice for workmanship on building sites. To ensure compliance with these standards we strongly recommend that a calculated fixing specification be obtained from Sandtoft Technical Support or using Sandtoft's online All4Roof tool: www.all4roof.co.uk



Fittings

Left Hand Verge

418 x 289 x 16mm



Left Hand Half Tile

418 x 145 x 16mm



Right Hand Half Tile

418 x 186 x 16mm



Cloaked Verge

430 x 125 x 30mm



LH & RH available (RH shown)

Accessories

Tile Clip

Nail size 55 x 3.35mm



Eaves Clip¹

Nail size 20 x 3.35mm



Verge Clip

Nail size 20 x 3.35mm



In-Line Vent^{2,4}

453 x 335 x 85mm



Additional Fittings

Cowl Vent^{3,4}

Associated Ridge / Hip

Multi Angle Duracoat® Ridge 457mm



Tile Dimensions

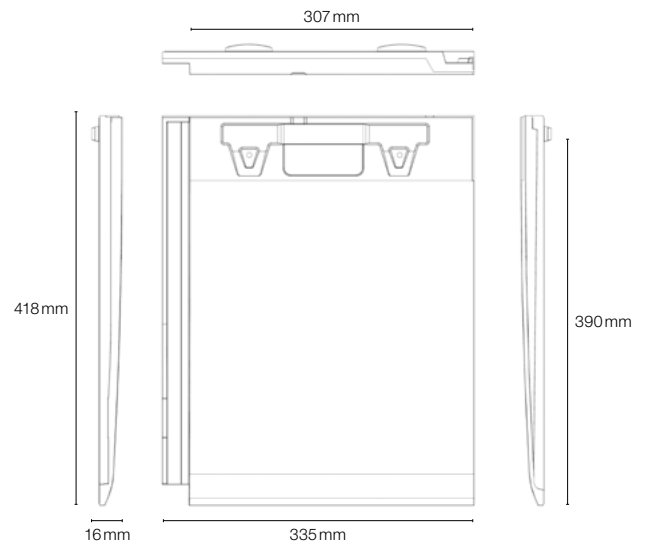

Associated Systems

Ridge/Hip Systems

- MA Profile Ridge Pack 6m
- MA Roll Ridge & Hip Pack 6m
- MA Profile MonoRidge Pack 6m
- Mortarless Hip/Valley Tile Top Clip
- Mortarless Hip/Valley Tail Clip TLE

Dry Verge Systems

- LH Dry Verge Unit
- RH Dry Verge Unit
- LH Dry Verge Eaves Unit
- RH Dry Verge Eaves Unit
- Ridge Closure Comb
- Ridge End Cap

Additional Systems

- 10mm Eaves Ventilation Pack
- 25mm Eaves Ventilation Pack
- Top Abutment Ventilator Kit

BIM Object
Download



¹ When used in conjunction with Over Fascia Ventilator Strip, nail length should be increased to 40mm for 10mm Over Fascia Ventilator Strip, or 50mm for 25mm Over Fascia Ventilator Strip.

² Requires Pipe Adaptor & Flexi Pipe for connection to soil or mechanical extraction.

³ Requires Flexi Pipe for connection to soil or mechanical extraction.

⁴ Not suitable for roof pitches below 22.5°.

All dimensions are nominal and taken from the drawing. Actual product dimensions may vary slightly from those referenced above.

RIVIUS

Clay



Featuring a riven surface and dressed edges with a colour permanent ceramic finish, this large format interlocking slate offers significant cost savings over double lap slate products.

Product Technical Information Sheet

Roof Tiling	
Minimum roof pitch	22.5°
Headlap (minimum)	75 mm
Headlap (maximum)	120 mm
Batten spacing at maximum gauge [†]	343 mm
Batten spacing at minimum gauge [†]	298 mm
Size of tile ¹	418 x 335 mm
Covering capacity	9.5 tiles per m ² at 75 mm headlap
Cover width	307 mm
Profile depth	16 mm
Hanging length	390 mm
Weight as laid	39.9 kg per m ² at 75 mm headlap
Weight per 1000 (including pallet and packaging)	4.4 tonnes
Weight per tile	4.2 kg
Weight per pallet (including pallet and packaging)	1.056 tonnes
Bond	Cross / Broken
Quantity per pallet	240
Quantity per row/band	40
Quantity per mini pack	5
Quantity per layer	120
Mini packs per row	8
Battens per m ²	3.0m at 75 mm headlap
Batten size - up to 450 mm rafter centres	38 x 25 mm
Batten size - up to 600 mm rafter centres	50 x 25 mm
Nail size/type for tiles	45 x 3.35 mm aluminium ring shank clout head
Nail size/type for metal tile clips	55 x 3.35 mm aluminium ring shank clout head

[†]Clay tiles are subject to small variations in size because of drying and firing shrinkage in the manufacturing process. Before deciding on the batten gauge and linear coverage, the roof tiler should inspect each batch of tiles to ensure that the correct minimum headlap and sidelap are achieved. Unless otherwise stated, data is based on the tiles laid at minimum headlap.

Product specification is subject to change and will be updated accordingly.

Note: Lead times may apply. Colour availability may vary.

Sanded

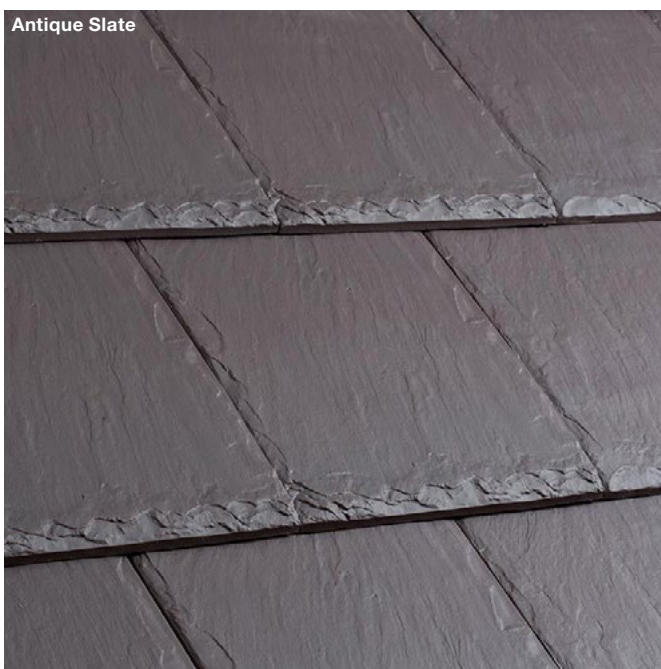

Tile Fixing

Sandtoft roof tiles must be laid and fixed to comply with BS 5534: the British Standard Code of practice for slating and tiling, and BS 8000: Part 6: the British Standard Code of practice for workmanship on building sites. To ensure compliance with these standards we strongly recommend that a calculated fixing specification be obtained from Sandtoft Technical Support or using Sandtoft's online All4Roof tool: www.all4roof.co.uk

All4Roof

Fittings

Left Hand Verge

418 x 289 x 16mm



Left Hand Half Tile

418 x 145 x 16mm



Right Hand Half Tile

418 x 186 x 16mm



Cloaked Verge

430 x 125 x 30mm



LH & RH available (RH shown)

Accessories

Tile Clip

Nail size 55 x 3.35mm



Eaves Clip¹

Nail size 20 x 3.35mm



Verge Clip

Nail size 20 x 3.35mm



In-Line Vent^{2,4}

453 x 335 x 85mm



Additional Fittings

Cowl Vent^{3,4}

Tile Dimensions

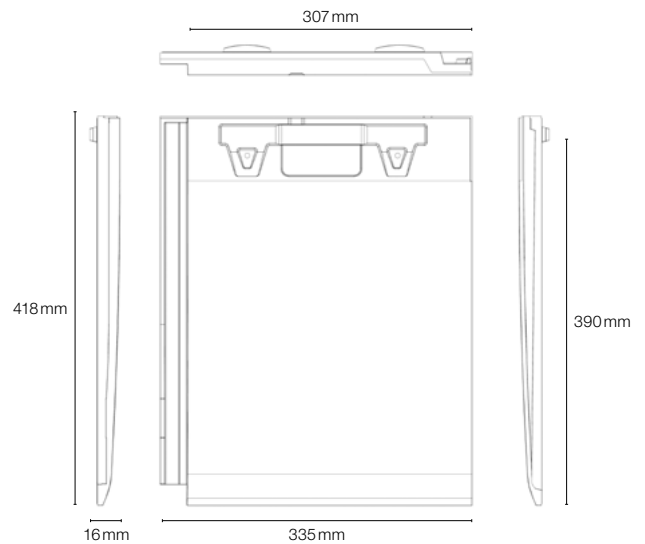

Associated Systems

Ridge/Hip Systems

MA Profile Ridge Pack 6m
MA Roll Ridge & Hip Pack 6m
MA Profile MonoRidge Pack 6m
Mortarless Hip/Valley Tile Top Clip
Mortarless Hip/Valley Tail Clip TLE

Additional Systems

10mm Eaves Ventilation Pack
25mm Eaves Ventilation Pack
Top Abutment Ventilator Kit

Dry Verge Systems

LH Dry Verge Unit
RH Dry Verge Unit
LH Dry Verge Eaves Unit
RH Dry Verge Eaves Unit
Ridge Closure Comb
Ridge End Cap

Associated Ridge / Hip

Multi Angle Duracoat® Ridge 457mm



BIM Object
Download



¹ When used in conjunction with Over Fascia Ventilator Strip, nail length should be increased to 40mm for 10mm Over Fascia Ventilator Strip, or 50mm for 25mm Over Fascia Ventilator Strip.

² Requires Pipe Adaptor & Flexi Pipe for connection to soil or mechanical extraction.

³ Requires Flexi Pipe for connection to soil or mechanical extraction.

⁴ Not suitable for roof pitches below 22.5°.

All dimensions are nominal and taken from the drawing. Actual product dimensions may vary slightly from those referenced above.



Contemporary, large format, flat interlocking tile which has been designed to perform down to 22.5° and also as a vertical cladding solution.

Product Technical Information Sheet

Roof Tiling	
Minimum roof pitch	22.5°
Headlap (minimum)	102 mm
Headlap (maximum)	162 mm
Batten spacing at maximum gauge†	370 mm
Batten spacing at minimum gauge†	310 mm
Size of tile†	472 x 303 mm
Covering capacity	10.4 tiles per m ² at 102 mm headlap
Cover width	262 mm
Profile depth	31 mm
Hanging length	440 mm
Weight as laid	45.8 kg per m ²
Weight per 1000 (including pallet and packaging)	4.42 tonnes
Weight per tile	4.4 kg
Weight per pallet (including pallet and packaging)	1.06 tonnes
Bond	Cross / Broken
Quantity per pallet	240
Battens per m ²	2.8 m at 102 mm headlap
Batten size - up to 450 mm rafter centres	38 x 25 mm
Batten size - up to 600 mm rafter centres	50 x 25 mm
Nail size/type for tiles	55 x 3.35 mm aluminium ring shank clout head
Nail size/type for metal tile clips	Integrated with clip

†Clay tiles are subject to small variations in size because of drying and firing shrinkage in the manufacturing process. Before deciding on the batten gauge and linear coverage, the roof tiler should inspect each batch of tiles to ensure that the correct minimum headlap and sidelap are achieved. Unless otherwise stated, data is based on the tiles laid at minimum headlap.

Product specification is subject to change and will be updated accordingly.

Note: Lead times may apply. Colour availability may vary.

Smooth

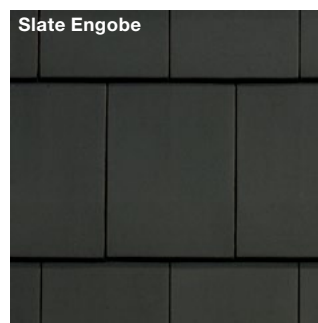
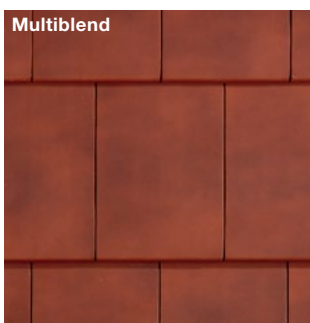

Tile Fixing

Sandtoft roof tiles must be laid and fixed to comply with BS 5534: the British Standard Code of practice for slating and tiling, and BS 8000: Part 6: the British Standard Code of practice for workmanship on building sites. To ensure compliance with these Standards we strongly recommend that a calculated fixing specification be obtained from Sandtoft Technical Support or using Sandtoft's online tool at www.all4roof.co.uk

All4Roof

Fittings

Left Hand Verge

472 x 262 x 31 mm



Left Hand Half Tile

472 x 132 x 31 mm



Right Hand Half Tile

472 x 177 x 31 mm



Cloaked Verge

472 x 253 x 100 mm



LH & RH available (LH shown)
Lead times may apply

Accessories

Tile Clip



Nail integral to clip

Eaves Clip¹

Nail size 20 x 3.35 mm



Verge Clip

Nail size 20 x 3.35 mm



In-Line Vent^{2,3}

540 x 303 x 145 mm



Tile Dimensions

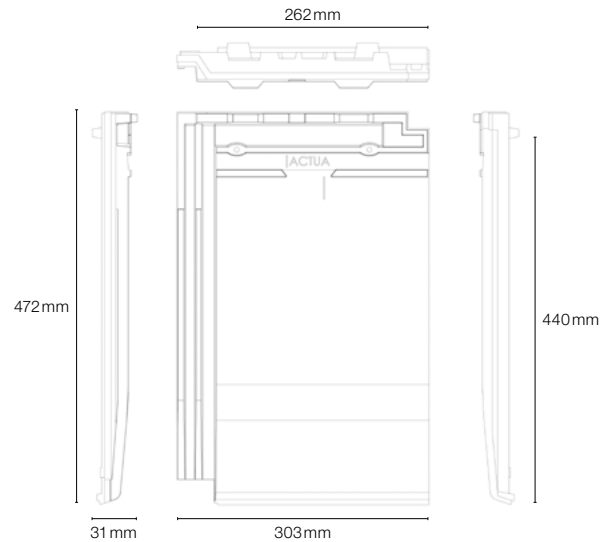

Associated Systems

Ridge/Hip Systems

MA Profile Ridge Pack 6m
MA Roll Ridge & Hip Pack 6m
MA Profile MonoRidge Pack 6m
Mortarless Hip/Valley Tile Top Clip
Mortarless Hip/Valley Tail Clip STD

Additional Systems

10mm Eaves Ventilation Pack
25mm Eaves Ventilation Pack
Top Abutment Ventilator Kit

Dry Verge Systems

Deep Profile Continuous Dry Verge
Verge Connector
Eaves Stop End

Associated Ridge / Hip

Multi Angle Duracoat® Ridge 457mm



BIM Object
Download



¹ When used in conjunction with Over Fascia Ventilator Strip, nail length should be increased to 40mm for 10mm Over Fascia Ventilator Strip, or 50mm for 25mm Over Fascia Ventilator Strip.

² Requires Flexi Pipe for connection to soil or mechanical extraction.

³ Not suitable for roof pitches below 22.5°.

All dimensions are nominal and taken from the drawing.
Actual product dimensions may vary slightly from those referenced above.

NEO PLUS

Clay



Introducing the Neo Plus, our improved and updated Neo Pantile. We have taken this classic design and re-engineered it for improved performance and even easier installation.

Product Technical Information Sheet

Roof Tiling

Minimum roof pitch*	20°
Headlap (minimum)	75 mm
Headlap (maximum)	120 mm
Batten spacing at maximum gauge†	309 mm
Batten spacing at minimum gauge†	264 mm
Size of tile†	387 x 246 mm
Covering capacity	14.9 tiles per m ² at 75 mm headlap
Cover width	218 mm
Profile depth	69 mm
Hanging length	357 mm
Weight as laid	40.3 kg per m ²
Weight per 1000 (including pallet and packaging)	2.809 tonnes
Weight per tile	2.7 kg
Weight per pallet (including pallet and packaging)	0.809 tonnes
Bond	Straight
Quantity per pallet	288
Quantity per row/band	6 per band / 36 per row
Quantity per layer	72
Battens per m ²	3.3m at 75 mm headlap
Batten size - up to 450 mm rafter centres	38 x 25 mm
Batten size - up to 600 mm rafter centres	50 x 25 mm
Nail size/type for tiles	45 x 3.35 mm aluminium ring shank clout head
Nail size/type for metal tile clips	55 x 3.35 mm aluminium ring shank clout head

*For projects where the rafters are below 22.5 degrees the roof substructure must be installed in accordance with the Sandtoft low pitch installation guide. Rafter length restrictions apply at minimum roof pitch.

†Clay tiles are subject to small variations in size because of drying and firing shrinkage in the manufacturing process. Before deciding on the batten gauge and linear coverage, the roof tiler should inspect each batch of tiles to ensure that the correct minimum headlap and sidelap are achieved. Unless otherwise stated, data is based on the tiles laid at minimum headlap.

Product specification is subject to change and will be updated accordingly.

Note: Lead times may apply. Colour availability may vary.

Smooth

Antique Slate

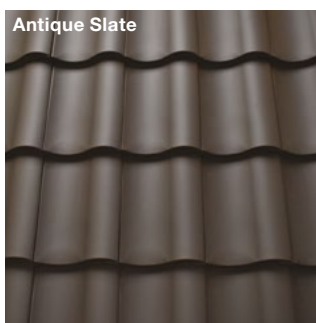

Flanders

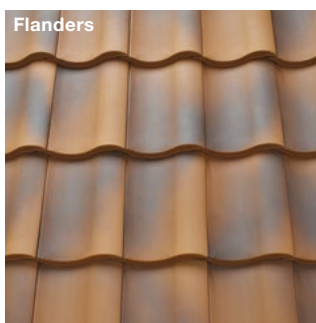

Natural Red

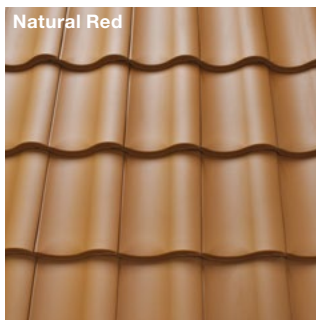

Tuscan

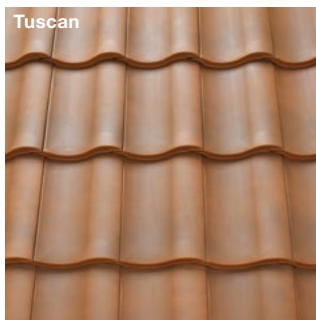

Tile Fixing

Sandtoft roof tiles must be laid and fixed to comply with BS 5534: the British Standard Code of practice for slating and tiling, and BS 8000: Part 6: the British Standard Code of practice for workmanship on building sites. To ensure compliance with these standards we strongly recommend that a calculated fixing specification be obtained from Sandtoft Technical Support or using Sandtoft's online All4Roof tool: www.all4roof.co.uk

All4Roof

Fittings

Left Hand Verge

387 x 246 x 69mm



Cloaked Verge

392 x 290 x 135mm



LH & RH available (LH shown)

Accessories

Tile Clip¹

Nail size 55 x 3.35mm



Eaves Clip²

Nail size 20 x 3.35mm



Verge Clip

Nail size 20 x 3.35mm



In-Line Vent^{3,5}

384 x 245 x 125mm



Cowl Vent^{4,5}

387 x 246mm



Associated Ridge / Hip

Half Round Ridge 305mm



Third Round Ridge 305mm



Tile Dimensions

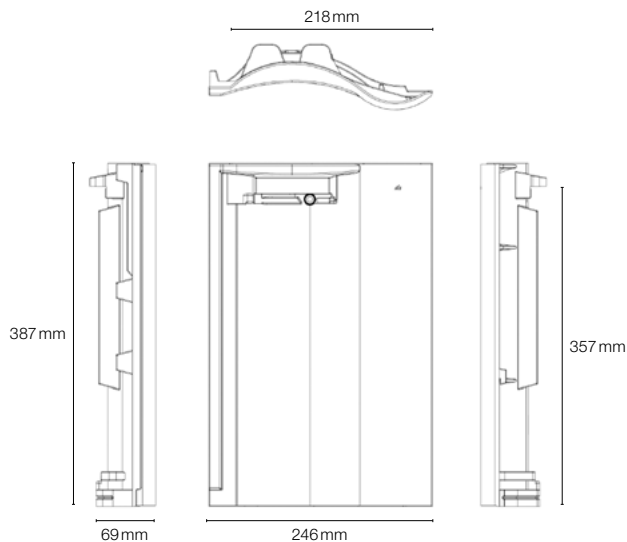

Associated Systems

Ridge/Hip Systems

HR Roll Ridge Pack 6m CLY
HR Profile Ridge Pack 6m CLY⁶
TR Roll Hip Pack 6m CLY
HR Profile MonoRidge Pack 6m CLY⁶
Mortarless Hip/Valley Tile Top Clip
Mortarless Hip/Valley Tail Clip STD
Profile Dry Ridge Fillers
Double Dentil Slip

Dry Verge Systems

LH Multiverge Unit
RH Multiverge Unit
LH Multiverge Eaves Unit
RH Multiverge Eaves Unit
Ridge Closure Comb
Ridge End Cap

Additional Systems

10mm Eaves Ventilation Pack
25mm Eaves Ventilation Pack
Top Abutment Ventilator Kit⁶
Bird Comb Filler

BIM Object
Download



¹ Plastic clip also available.

² When used in conjunction with Over Fascia Ventilator Strip, nail length should be increased to 40mm for 10mm Over Fascia Ventilator Strip, or 50mm for 25mm Over Fascia Ventilator Strip.

³ Requires Pipe Adaptor & Flexi Pipe for connection to soil or mechanical extraction.

⁴ Requires Flexi Pipe for connection to soil or mechanical extraction.

⁵ Not suitable for roof pitches below 22.5°.

⁶ Profile Dry Ridge Fillers sold separately in box quantities sufficient for 6m of Ridge/12m of Monoridge.

All dimensions are nominal and taken from the drawing.
Actual product dimensions may vary slightly from those referenced above.

NEW COUNTY

Pantile
Clay



The County Pantile combines the visual qualities of a traditional clay pantile, with the enhanced performance of a double interlocking design.

Product Technical Information Sheet

Roof Tiling

Minimum roof pitch	22.5°
Headlap (minimum)	62 mm
Headlap (maximum)	77 mm
Batten spacing at maximum gauge [†]	320 mm
Batten spacing at minimum gauge [†]	305 mm
Size of tile [†]	382 x 256 mm
Covering capacity	15.5 tiles per m ² at 62 mm headlap
Cover width	202 mm
Profile depth	65 mm
Hanging length	355 mm
Weight as laid	38.0 kg per m ² at 62 mm headlap
Weight per 1000 (including pallet and packaging)	2.505 tonnes
Weight per tile	2.45 kg
Weight per pallet (including pallet and packaging)	0.963 tonnes
Bond	Straight
Quantity per pallet [‡]	378
Quantity per row/band	42
Quantity per mini pack	6
Quantity per layer	126
Mini packs per row	7
Battens per m ²	3.2m at 62mm headlap
Batten size - up to 450mm rafter centres	38 x 25mm
Batten size - up to 600mm rafter centres	50 x 25mm
Nail size/type for tiles	38 x 3.35mm aluminium ring shank clout head
Nail size/type for metal tile clips	Nail integrated with clip

[†] Clay tiles are subject to small variations in size because of drying and firing shrinkage in the manufacturing process. Before deciding on the batten gauge and linear coverage, the roof tiler should inspect each batch of tiles to ensure that the correct minimum headlap and sidelap are achieved. Unless otherwise stated, data is based on the tiles laid at minimum headlap.

[‡] Pallet quantity for Antique Slate is 252.

Product specification is subject to change and will be updated accordingly.

Note: Lead times may apply. Colour availability may vary.

Smooth

Antique Slate



Mixed Russet

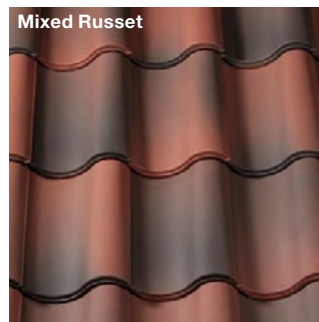

Natural Red

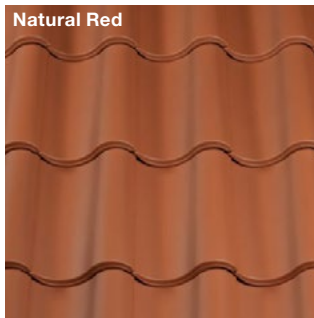

Old Copper



Tile Fixing

Sandtoft roof tiles must be laid and fixed to comply with BS 5534: the British Standard Code of practice for slating and tiling, and BS 8000: Part 6: the British Standard Code of practice for workmanship on building sites. To ensure compliance with these standards we strongly recommend that a calculated fixing specification be obtained from Sandtoft Technical Support or using Sandtoft's online All4Roof tool: www.all4roof.co.uk

All4Roof

Fittings

Left Hand Verge

382 x 292 x 65mm



Cloaked Verge

382 x 292 x 125mm



LH and RH available (LH shown)

Accessories

Tile Clip



Nail integrated with clip

Eaves Clip¹

Nail size 50 x 3.35mm



Verge Clip

Nail size 20 x 3.35mm



In-Line Vent^{2,3}

452 x 458 x 143mm



Associated Ridge / Hip

Koramic 325mm Ridge



Tile Dimensions

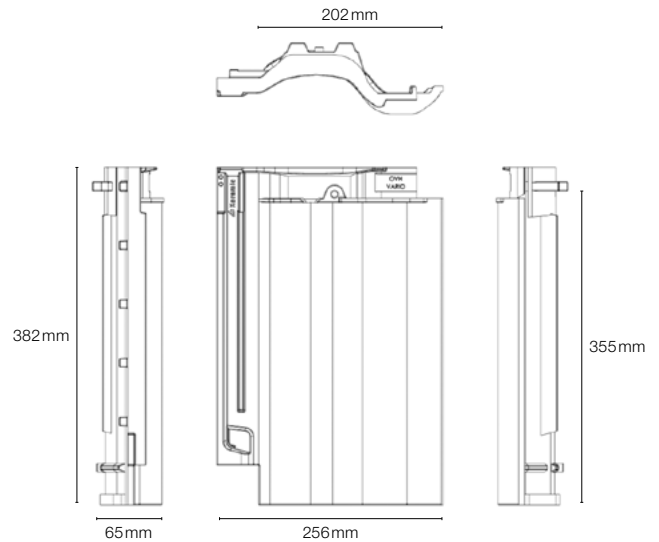

Associated Systems

Ridge/Hip Systems

Koramic 325 Profile Ridge⁴
Profile Dry Ridge Fillers
Double Dentil Slip

Additional Systems

10mm Eaves Ventilation Pack
25mm Eaves Ventilation Pack
Top Abutment Ventilator Kit⁴
Bird Comb Filler

BIM Object
Download



¹ When used in conjunction with Over Fascia Ventilator Strip, nail length should be increased to 40mm for 10mm Over Fascia Ventilator Strip, or 50mm for 25mm Over Fascia Ventilator Strip.
² Requires Pipe Adaptor & Flexi Pipe for connection to soil or mechanical extraction.
³ Not suitable for roof pitches below 22.5°.
⁴ Profile Dry Ridge Fillers sold separately in box quantities sufficient for 6m of Ridge/12m of Monoridge.

All dimensions are nominal and taken from the drawing.
Actual product dimensions may vary slightly from those referenced above.

OLD ENGLISH

Pantile
Clay



A traditional clay pantile offering beauty by design. This classic shape, with its carefully proportioned profile, creates a long lasting, beautiful roof.

Product Technical Information Sheet

Roof Tiling

Minimum roof pitch	30°
Headlap	75 mm
Batten spacing (fixed gauge) [†]	290 mm
Size of tile [†]	365 x 250 mm
Covering capacity	17.3 tiles per m ² at 75 mm headlap
Cover width	200 mm
Profile depth	45 mm
Hanging length	340 mm
Weight as laid	41.6 kg per m ²
Weight per 1000 (including pallet and packaging)	2.55 tonnes
Weight per tile	2.4 kg
Weight per pallet (including pallet and packaging)	0.734 tonnes
Bond	Straight
Quantity per pallet	288
Quantity per row/band	36
Quantity per mini pack	9
Quantity per layer	144
Mini packs per row	4
Battens per m ²	3.5m at 75 mm headlap
Batten size - up to 450 mm rafter centres	38 x 25 mm
Batten size - up to 600 mm rafter centres	50 x 25 mm
Nail size/type for tiles	38 x 3.35 mm aluminium ring shank clout head
Nail size/type for metal tile clips	Nail integrated with clip

[†]Clay tiles are subject to small variations in size because of drying and firing shrinkage in the manufacturing process. Before deciding on the batten gauge and linear coverage, the roof tiler should inspect each batch of tiles to ensure that the correct minimum headlap and sidelap are achieved. Unless otherwise stated, data is based on the tiles laid at minimum headlap.

Product specification is subject to change and will be updated accordingly.

Note: Lead times may apply. Colour availability may vary.

Smooth

Antique Slate



Flanders



Natural Red



Tile Fixing

Sandtoft roof tiles must be laid and fixed to comply with BS 5534: the British Standard Code of practice for slating and tiling, and BS 8000: Part 6: the British Standard Code of practice for workmanship on building sites. To ensure compliance with these standards we strongly recommend that a calculated fixing specification be obtained from Sandtoft Technical Support or using Sandtoft's online All4Roof tool: www.all4roof.co.uk

All4Roof

Fittings

Left Hand Verge

365 x 272 x 45mm



Accessories

Tile Clip



Nail integrated with clip

Eaves Clip¹

Nail size 20 x 3.35mm



Verge Clip

Nail size 20 x 3.35mm



In-Line Vent^{2,4}

435 x 445 x 127mm



Cowl Vent^{3,4}

408 x 327mm



Tile Dimensions

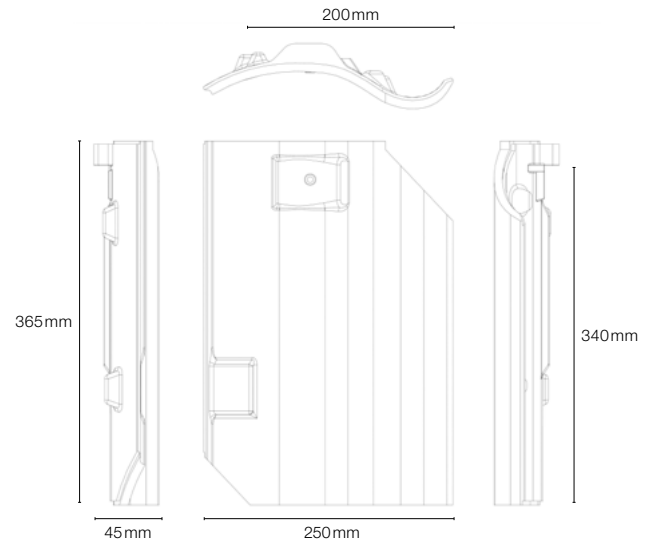

Associated Systems

Ridge/Hip Systems

Double Dentil Slip

Additional Systems

10mm Eaves Ventilation Pack

25mm Eaves Ventilation Pack

Associated Ridge / Hip

Half Round Ridge 305mm



Third Round Ridge 305mm



¹ When used in conjunction with Over Fascia Ventilator Strip, nail length should be increased to 40mm for 10mm Over Fascia Ventilator Strip, or 50mm for 25mm Over Fascia Ventilator Strip.

² Requires Pipe Adaptor & Flexi Pipe for connection to soil or mechanical extraction.

³ Requires Flexi Pipe for connection to soil or mechanical extraction.

⁴ Not suitable for roof pitches below 22.5°.

All dimensions are nominal and taken from the drawing.
Actual product dimensions may vary slightly from those referenced above.

BIM Object
Download



ARCADIA

Pantile

Clay



The Arcadia pantile provides the look of an aged pantile from the day it is installed on the roof. It replicates the charm and character of reclaimed pantiles from new.

Product Technical Information Sheet

Roof Tiling	
Minimum roof pitch	30°
Headlap	75 mm
Batten spacing (fixed gauge) [†]	290 mm
Size of tile [†]	365 x 250 mm
Covering capacity	17.3 tiles per m ²
Cover width	200 mm
Profile depth	45 mm
Hanging length	340 mm
Weight as laid	41.6 kg per m ²
Weight per 1000 (including pallet and packaging)	2.55 tonnes
Weight per tile	2.4 kg
Weight per pallet (including pallet and packaging)	0.734 tonnes
Bond	Straight
Quantity per pallet	288
Quantity per row/band	36
Quantity per mini pack	9
Quantity per layer	144
Mini packs per row	4
Battens per m ²	3.5 m
Batten size - up to 450 mm rafter centres	38 x 25 mm
Batten size - up to 600 mm rafter centres	50 x 25 mm
Nail size/type for tiles	38 x 3.35 mm aluminium ring shank clout head
Nail size/type for metal tile clips	Nail integrated with clip

[†]Clay tiles are subject to small variations in size because of drying and firing shrinkage in the manufacturing process. Before deciding on the batten gauge and linear coverage, the roof tiler should inspect each batch of tiles to ensure that the correct minimum headlap and sidelap are achieved. Unless otherwise stated, data is based on the tiles laid at minimum headlap.

Product specification is subject to change and will be updated accordingly.

Note: Lead times may apply. Colour availability may vary.

Colours - Weathered

Reclaimed



Tile Fixing

Sandtoft roof tiles must be laid and fixed to comply with BS 5534: the British Standard Code of practice for slating and tiling, and BS 8000: Part 6: the British Standard Code of practice for workmanship on building sites. To ensure compliance with these standards we strongly recommend that a calculated fixing specification be obtained from Sandtoft Technical Support or using Sandtoft's online All4Roof tool: www.all4roof.co.uk

All4Roof

Accessories

Tile Clip



Nail integrated with clip

Eaves Clip¹

Nail size 20 x 3.35 mm



Verge Clip (LH)

Nail size 20 x 3.35 mm



Verge Clip (RH)

Nail size 20 x 3.35 mm



In-Line Vent^{2,4}

435 x 445 x 127 mm



Cowl Vent^{3,4}

365 x 250 mm



Tile Dimensions

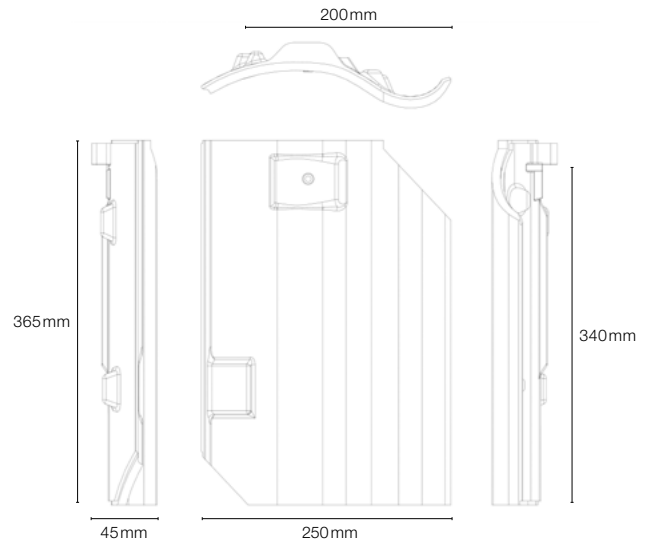

Associated Systems

Ridge/Hip Systems

Double Dentil Slip

Additional Systems

10 mm Eaves Ventilation Pack

25 mm Eaves Ventilation Pack

Associated Ridge / Hip

Half Round Ridge 305mm



Third Round Ridge 305mm



¹ When used in conjunction with Over Fascia Ventilator Strip, nail length should be increased to 40mm for 10mm Over Fascia Ventilator Strip, or 50mm for 25mm Over Fascia Ventilator Strip.

² Requires Pipe Adaptor & Flexi Pipe for connection to soil or mechanical extraction.

³ Requires Flexi Pipe for connection to soil or mechanical extraction.

⁴ Not suitable for roof pitches below 22.5°.

All dimensions are nominal and taken from the drawing. Actual product dimensions may vary slightly from those referenced above.

BIM Object
Download



451 OLD HOLLOW

Pantile

Clay



A reclaimed style tile designed to complement reclaimed brick, this traditional pantile can provide an authentic weathered appearance.

Product Technical Information Sheet

Roof Tiling

Minimum roof pitch	25°
Headlap	75 mm
Batten spacing (fixed gauge)†	273 mm
Size of tile†	348 x 246 mm
Covering capacity	18.9 tiles per m ²
Cover width	194 mm
Profile depth	65 mm
Hanging length	325 mm
Weight as laid	43.5 kg per m ²
Weight per 1000 (including pallet and packaging)	2.39 tonnes
Weight per tile	2.3 kg
Weight per pallet (including pallet and packaging)	1.033 tonnes
Bond	Straight
Quantity per pallet‡	432
Battens per m ²	3.7 m
Batten size - up to 450mm rafter centres	38 x 25 mm
Batten size - up to 600mm rafter centres	50 x 25 mm
Nail size/type for tiles	45 x 3.35 mm aluminium ring shank clout head
Nail size/type for metal tile clips	Integrated with clip

†Clay tiles are subject to small variations in size because of drying and firing shrinkage in the manufacturing process. Before deciding on the batten gauge and linear coverage, the roof tiler should inspect each batch of tiles to ensure that the correct minimum headlap and sidelap are achieved. Unless otherwise stated, data is based on the tiles laid at minimum headlap.

‡Pallet quantity for Braised Blue and Victorian Braised Blue is 320.

Product specification is subject to change and will be updated accordingly.

Note: Lead times may apply. Colour availability may vary.

Smooth

Anthracite



Black Glazed*



Braised Blue*

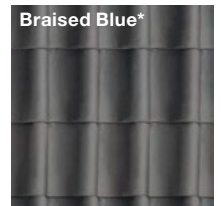

Natural Red



Rustic

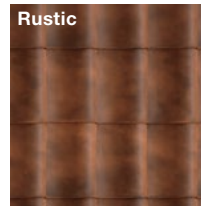

Colours - Weathered

Victorian

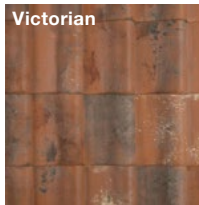

Victorian Braised Blue

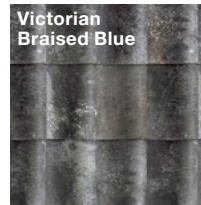

Tile Fixing

Sandtoft roof tiles must be laid and fixed to comply with BS 5534: the British Standard Code of practice for slating and tiling, and BS 8000: Part 6: the British Standard Code of practice for workmanship on building sites. To ensure compliance with these standards we strongly recommend that a calculated fixing specification be obtained from Sandtoft Technical Support or using Sandtoft's online All4Roof tool: www.all4roof.co.uk

All4Roof

* Lead times may apply.

Due to the limitations of the printing process and screen calibration settings images shown may not be an accurate representation of the final product colour. Please obtain a sample if unsure.

Fittings

Left Hand Vergé

348 x 280 x 55 mm



Cloaked Vergé

348 x 285 x 65 mm



LH and RH available (LH shown)
Lead times may apply

Accessories

Tile Clip

Nail integrated with clip



Eaves Clip¹

Nail size 20 x 3.35 mm



Left Hand Vergé Clip

Nail size 20 x 3.35 mm



Right Hand Vergé Clip

Nail size 20 x 3.35 mm



Associated Ridge / Hip

Koramic 325mm Ridge



Tile Dimensions

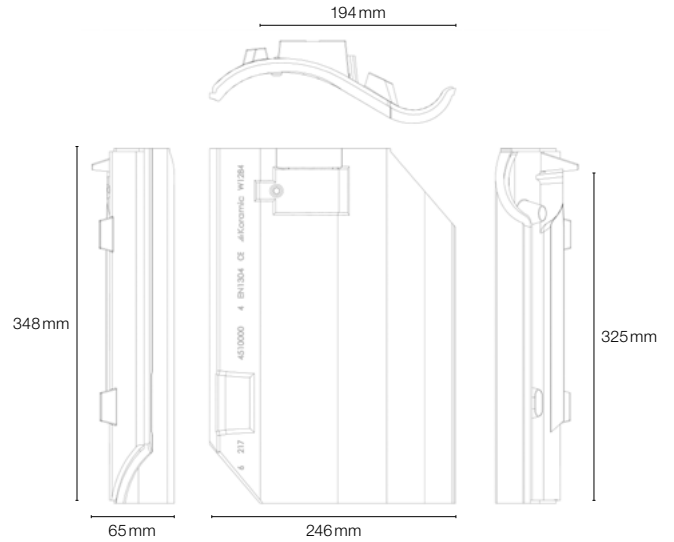

Associated Systems

Additional Systems

10mm Eaves Ventilation Pack

25mm Eaves Ventilation Pack

BIM Object
Download



¹ When used in conjunction with Over Fascia Ventilator Strip, nail length should be increased to 40mm for 10mm Over Fascia Ventilator Strip, or 50mm for 25mm Over Fascia Ventilator Strip.

All dimensions are nominal and taken from the drawing.
Actual product dimensions may vary slightly from those referenced above.

OLYMPUS

Double Pantile

Clay



A New Generation clay tile designed to provide all the benefits of a natural clay roof at an affordable price thanks to its innovative design and large format size.

Product Technical Information Sheet

Roof Tiling

Minimum roof pitch	22.5°
Headlap (minimum)	75 mm
Headlap (maximum)	120 mm
Batten spacing at maximum gauge [†]	333 mm
Batten spacing at minimum gauge [†]	288 mm
Size of tile [†]	408 x 327 mm
Covering capacity	10.2 tiles per m ² at 75 mm headlap
Cover width	295 mm
Profile depth	57 mm
Hanging length	382 mm
Weight as laid	35.2 kg per m ² at 75 mm headlap
Weight per 1000 (including pallet and packaging)	3.69 tonnes
Weight per tile	3.45 kg
Weight per pallet (including pallet and packaging)	0.776 tonnes
Bond	Straight
Quantity per pallet	210
Quantity per row/band	35
Quantity per mini pack	5
Quantity per layer	105
Mini packs per row	7
Battens per m ²	3.1 m at 75 mm headlap
Batten size - up to 450 mm rafter centres	38 x 25 mm
Batten size - up to 600 mm rafter centres	50 x 25 mm
Nail size/type for tiles	65 x 3.75 mm aluminium ring shank clout head
Nail size/type for metal tile clips	55 x 3.35 mm aluminium ring shank clout head

[†]Clay tiles are subject to small variations in size because of drying and firing shrinkage in the manufacturing process. Before deciding on the batten gauge and linear coverage, the roof tiler should inspect each batch of tiles to ensure that the correct minimum headlap and sidelap are achieved. Unless otherwise stated, data is based on the tiles laid at minimum headlap.

Product specification is subject to change and will be updated accordingly.

Note: Lead times may apply. Colour availability may vary.

Smooth

Flanders



Natural Red

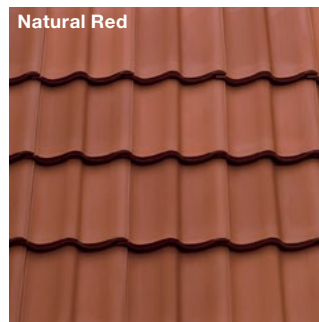

Tuscan

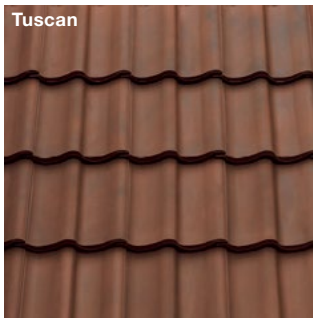

Tile Fixing

Sandtoft roof tiles must be laid and fixed to comply with BS 5534: the British Standard Code of practice for slating and tiling, and BS 8000: Part 6: the British Standard Code of practice for workmanship on building sites. To ensure compliance with these standards we strongly recommend that a calculated fixing specification be obtained from Sandtoft Technical Support or using Sandtoft's online All4Roof tool: www.all4roof.co.uk

All4Roof

Fittings

Left Hand Verge

408 x 330 x 57 mm



Accessories

Tile Clip¹

Nail size 55 x 3.35 mm



Eaves Clip²

Nail size 20 x 3.35 mm



Verge Clip

Nail size 20 x 3.35 mm



In-Line Vent^{3,5}

408 x 327 x 110 mm



Cowl Vent^{4,5}

408 x 327 mm



Associated Ridge / Hip

Half Round Duracoat® Ridge 457mm



Segmental Duracoat® Ridge 457mm



Tile Dimensions

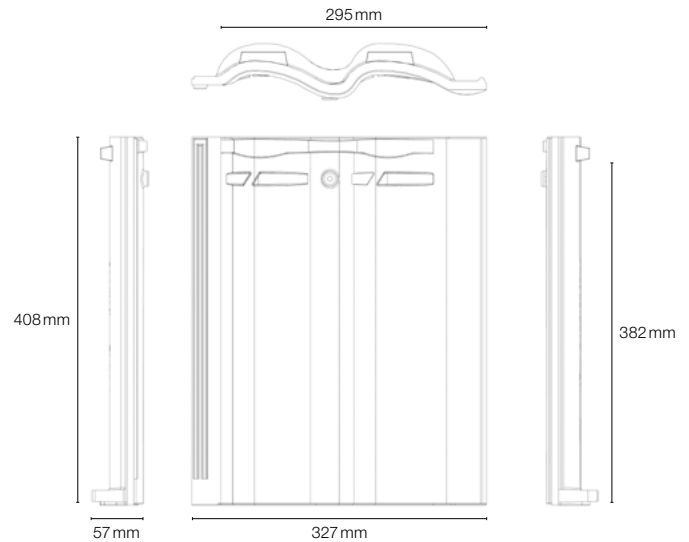

Associated Systems

Ridge/Hip Systems

HR Roll Ridge Pack 6m CON
HR Profile Ridge Pack 6m CON⁶
Seg Roll Hip Pack 6m CON
HR Profile MonoRidge Pack 6m CON⁶
Mortarless Hip/Valley Tile Top Clip
Mortarless Hip/Valley Tail Clip STD
Profile Dry Ridge Fillers

Additional Systems

10mm Eaves Ventilation Pack
25mm Eaves Ventilation Pack
Top Abutment Ventilator Kit⁶
Bird Comb Filler

Dry Verge Systems

LH Multiverge Unit
RH Multiverge Unit
RH Multiverge Eaves Unit
RH Multiverge Eaves Unit
Ridge Closure Comb
Ridge End Cap

BIM Object
Download



¹ Plastic clip also available.

² When used in conjunction with Over Fascia Ventilator Strip, nail length should be increased to 40mm for 10mm Over Fascia Ventilator Strip, or 50mm for 25mm Over Fascia Ventilator Strip.

³ Requires Pipe Adaptor & Flexi Pipe for connection to soil or mechanical extraction.

⁴ Requires Flexi Pipe for connection to soil or mechanical extraction.

⁵ Not suitable for roof pitches below 22.5°.

⁶ Profile Dry Ridge Fillers sold separately in box quantities sufficient for 6m of Ridge/12m of Monoridge.

All dimensions are nominal and taken from the drawing.

Actual product dimensions may vary slightly from those referenced above.

MODULA

Clay



Whether it's renovation or new build projects, the Modula Clay Double Roman can be installed quickly and efficiently with a cover width of 300mm.

Product Technical Information Sheet

Roof Tiling	
Minimum roof pitch*	17.5° at 100mm headlap 22.5° at 75mm headlap
Headlap (minimum)	75mm
Headlap (maximum)	120mm
Batten spacing at maximum gauge†	368mm
Batten spacing at minimum gauge†	323mm
Size of tile†	443 x 328mm
Covering capacity	9.7 tiles per m ² at 100mm headlap
	9.1 tiles per m ² at 75mm headlap
Cover width	300mm
Profile depth	54mm
Hanging length	416mm
Weight as laid	38.5 kg per m ² at 100mm headlap
	35.4kg per m ² at 75mm headlap
Weight per 1000 (including pallet and packaging)	4.05 tonnes
Weight per tile	3.89kg
Weight per pallet (including pallet and packaging)	0.972 tonnes
Bond	Straight
Quantity per pallet	240
Battens per m ²	3.0m at 100mm headlap
	2.8m at 75mm headlap
Batten size - up to 450mm rafter centres	38 x 25mm
Batten size - up to 600mm rafter centres	50 x 25mm
Nail size/type for tiles	45 x 3.35mm aluminium ring shank clout head
Nail size/type for tile clips	Integrated with clip

*For projects where the rafters are below 22.5 degrees the roof substructure must be installed in accordance with the Sandtoft low pitch installation guide. Rafter length restrictions apply at minimum roof pitch.

†Clay tiles are subject to small variations in size because of drying and firing shrinkage in the manufacturing process. Before deciding on the batten gauge and linear coverage, the roof tiler should inspect each batch of tiles to ensure that the correct minimum headlap and sidelap are achieved. Unless otherwise stated, data is based on the tiles laid at minimum headlap.

Product specification is subject to change and will be updated accordingly.

Note: Lead times may apply. Colour availability may vary.

Smooth

Chilton Red



Natural Red



Tile Fixing

Sandtoft roof tiles must be laid and fixed to comply with BS 5534: the British Standard Code of practice for slating and tiling, and BS 8000: Part 6: the British Standard Code of practice for workmanship on building sites. To ensure compliance with these standards we strongly recommend that a calculated fixing specification be obtained from Sandtoft Technical Support or using Sandtoft's online All4Roof tool: www.all4roof.co.uk

All4Roof

Fittings

Left Hand Verge

443 x 233 x 40mm

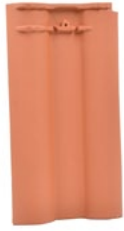

Half Tile

443 x 176 x 40mm



Cloaked Verge

443 x 199 x 110mm



LH and RH available (LH shown)

Accessories

Tile Clip



Nail integral to clip

Eaves Clip¹

Nail size 20 x 3.35mm



Verge Clip

Nail size 20 x 3.35mm



In-Line Vent^{2,3}

445 x 325 x 120mm



Associated Ridge / Hip

Half Round Duracoat® Ridge 457mm



Segmental Duracoat® Ridge 457mm



Tile Dimensions

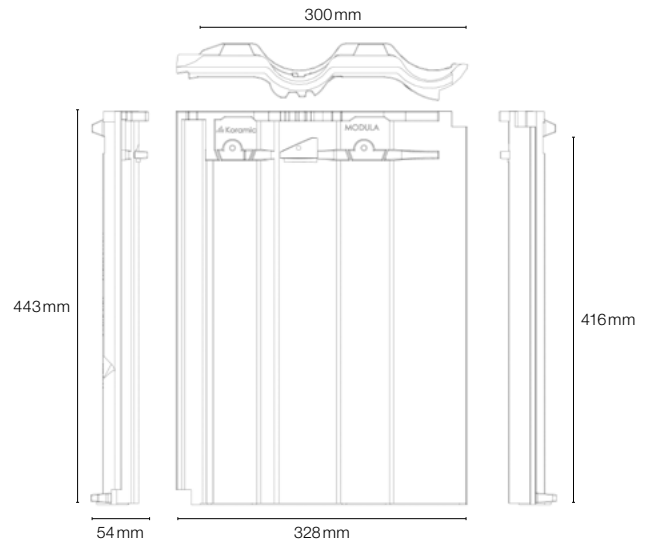

Associated Systems

Ridge/Hip Systems

- HR Roll Ridge Pack 6m CON
- Seg Roll Hip Pack 6m CON
- Mortarless Hip/Valley Tile Top Clip
- Mortarless Hip/Valley Tail Clip STD

Dry Verge Systems

- Deep Profile Continuous Dry Verge
- Verge Connector
- Eaves Stop End

Additional Systems

- 10mm Eaves Ventilation Pack
- 25mm Eaves Ventilation Pack

BIM Object
Download



¹ When used in conjunction with Over Fascia Ventilator Strip, nail length should be increased to 40mm for 10mm

Over Fascia Ventilator Strip, or 50mm for 25mm Over Fascia Ventilator Strip.

² Requires Pipe Adaptor & Flexi Pipe for connection to soil or mechanical extraction.

³ Not suitable for roof pitches below 22.5°.

All dimensions are nominal and taken from the drawing.

Actual product dimensions may vary slightly from those referenced above.

BRIDGWATER

Clay



The Sandtoft Bridgwater has been designed to satisfy the need for a traditional tapered clay double roman tile, predominantly found in the south west of England.

Product Technical Information Sheet

Roof Tiling

Minimum roof pitch	30°
Headlap	75 mm
Batten spacing (fixed gauge) [†]	345 mm
Size of tile [†]	420 x 340 mm
Covering capacity	9.6 tiles per m ²
Cover width	305 mm
Profile depth	42 mm
Hanging length	403 mm
Weight as laid	43.9 kg per m ²
Weight per 1000 (including pallet and packaging)	4.78 tonnes
Weight per tile	4.57 kg
Weight per pallet (including pallet and packaging)	0.888 tonnes
Bond	Straight
Quantity per pallet	186
Quantity per row/band	31
Quantity per layer	93
Battens per m ²	2.9 m
Batten size - up to 450 mm rafter centres	38 x 25 mm
Batten size - up to 600 mm rafter centres	50 x 25 mm
Nail size/type for tiles	38 x 3.35 mm aluminium ring shank clout head
Nail size/type for metal tile clips	55 x 3.35 mm aluminium ring shank clout head

[†]Clay tiles are subject to small variations in size because of drying and firing shrinkage in the manufacturing process. Before deciding on the batten gauge and linear coverage, the roof tiler should inspect each batch of tiles to ensure that the correct minimum headlap and sidelap are achieved. Unless otherwise stated, data is based on the tiles laid at minimum headlap.

Product specification is subject to change and will be updated accordingly.

Note: Lead times may apply. Colour availability may vary.

Smooth

Natural Red*



Somerset

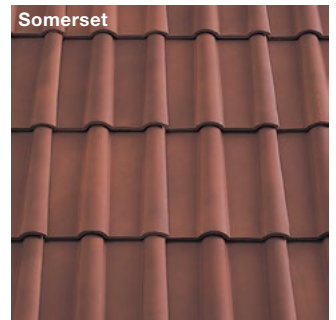

Tile Fixing

Sandtoft roof tiles must be laid and fixed to comply with BS 5534: the British Standard Code of practice for slating and tiling, and BS 8000: Part 6: the British Standard Code of practice for workmanship on building sites. To ensure compliance with these standards we strongly recommend that a calculated fixing specification be obtained from Sandtoft Technical Support or using Sandtoft's online All4Roof tool: www.all4roof.co.uk

All4Roof

* Made to order.

Due to the limitations of the printing process and screen calibration settings images shown may not be an accurate representation of the final product colour. Please obtain a sample if unsure.

Accessories

Tile Clip

Nail size 65 x 3.35mm



Eaves Clip¹

Nail size 20 x 3.35mm



Verge Clip

Nail size 20 x 3.35mm



Associated Ridge / Hip

Half Round Ridge 305mm



Third Round Ridge 305mm



Tile Dimensions

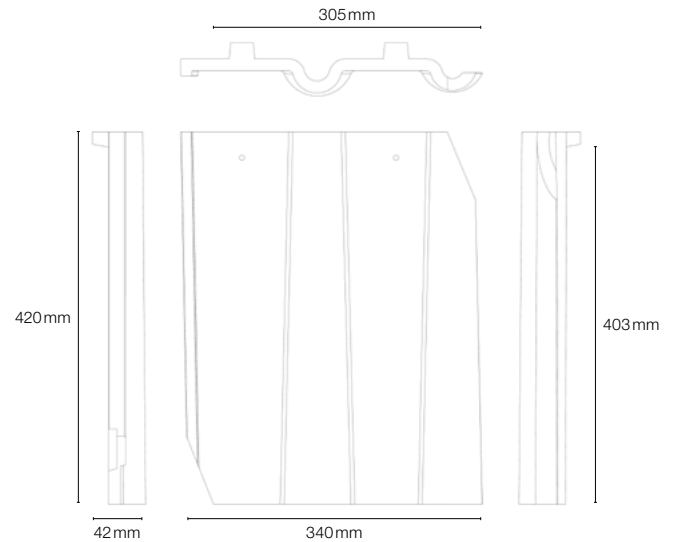

Associated Systems

Additional Systems

10mm Eaves Ventilation Pack

25mm Eaves Ventilation Pack

BIM Object
Download



¹ When used in conjunction with Over Fascia Ventilator Strip, nail length should be increased to 40mm for 10mm Over Fascia Ventilator Strip, or 50mm for 25mm Over Fascia Ventilator Strip.

² Requires Pipe Adaptor & Flexi Pipe for connection to soil or mechanical extraction.

³ Not suitable for roof pitches below 22.5°.

All dimensions are nominal and taken from the drawing.
Actual product dimensions may vary slightly from those referenced above.

GAELIC

Single Roman

Clay



A specialist clay tile with a delicate single roll, the Gaelic is ideal for refurbishment or new build work in conservation areas.

Product Technical Information Sheet

Roof Tiling

Minimum roof pitch	30°
Headlap	75 mm
Batten spacing (fixed gauge)†	267 mm
Size of tile†	342 x 255 mm
Covering capacity	17.0 tiles per m ²
Cover width	220 mm
Profile depth	43 mm
Hanging length	315 mm
Weight as laid	40.8 kg per m ²
Weight per 1000 (including pallet and packaging)	2.577 tonnes
Weight per tile	2.4 kg
Weight per pallet (including pallet and packaging)	0.670 tonnes
Quantity per pallet	260
Quantity per row/band	Bottom 43 Centre 43 Top 43
Quantity per layer	Bottom 86 Centre 86 Top 88
Battens per m ²	3.7 m
Batten size - up to 450 mm rafter centres	38 x 25 mm
Batten size - up to 600 mm rafter centres	50 x 25 mm
Nail size/type for tiles	50 x 3.35 mm aluminium ring shank clout head

†Clay tiles are subject to small variations in size because of drying and firing shrinkage in the manufacturing process. Before deciding on the batten gauge and linear coverage, the roof tiler should inspect each batch of tiles to ensure that the correct minimum headlap and sidelap are achieved. Unless otherwise stated, data is based on the tiles laid at minimum headlap.

Product specification is subject to change and will be updated accordingly.

Note: Lead times may apply. Colour availability may vary.

Smooth

Natural Red



Tile Fixing

Sandtoft roof tiles must be laid and fixed to comply with BS 5534: the British Standard Code of practice for slating and tiling, and BS 8000: Part 6: the British Standard Code of practice for workmanship on building sites. To ensure compliance with these standards we strongly recommend that a calculated fixing specification be obtained from Sandtoft Technical Support or using Sandtoft's online All4Roof tool: www.all4roof.co.uk

All4Roof

Accessories

Tile Clip

Nail size 65 x 3.35mm



Nail integral to clip

Eaves Clip¹

Nail size 20 x 3.35mm



Verge Clip

Nail size 20 x 3.35mm



Cowl Vent^{2,3}

342 x 255mm



Associated Ridge / Hip

Half Round Ridge 305mm



Third Round Ridge 305mm

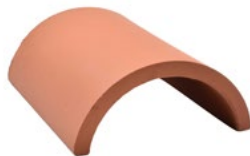

Tile Dimensions

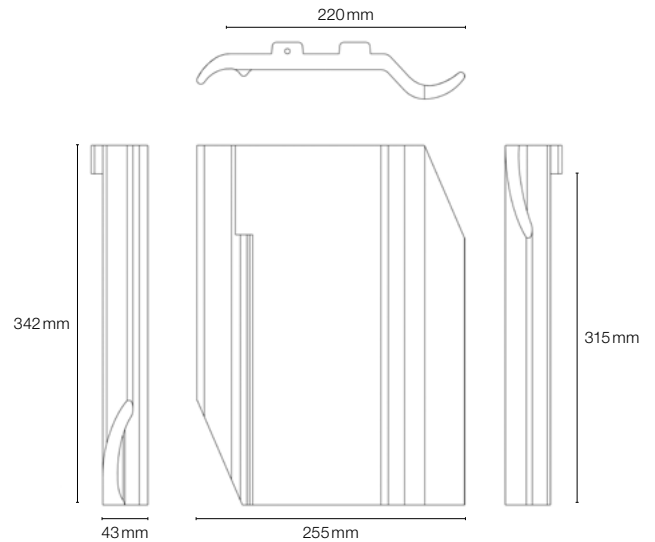

Associated Systems

Additional Systems

10mm Eaves Ventilation Pack

25mm Eaves Ventilation Pack

BIM Object
Download



¹ When used in conjunction with Over Fascia Ventilator Strip, nail length should be increased to 40mm for 10mm Over Fascia Ventilator Strip, or 50mm for 25mm Over Fascia Ventilator Strip.

² Requires Flexi Pipe for connection to soil or mechanical extraction.

³ Not suitable for roof pitches below 22.5°.

All dimensions are nominal and taken from the drawing.
Actual product dimensions may vary slightly from those referenced above.

TEMPEST 44

Single Roman

Clay



The Tempest is the original 'Roman' and has been manufactured since 1906. This single roman clay tile is ideal for refurbishment or new build projects in conservation areas.

Product Technical Information Sheet

Roof Tiling

Minimum roof pitch*	22°
Headlap	54 mm
Batten spacing (fixed gauge)†	248 mm
Size of tile†	302 x 221 mm
Covering capacity	20.7 tiles per m ²
Cover width	195 mm
Profile depth	38 mm
Hanging length	282 mm
Weight as laid	39.6 kg per m ²
Weight per 1000 (including pallet and packaging)	1.8 tonnes
Weight per tile	1.91 kg
Weight per pallet (including pallet and packaging)	1.296 tonnes
Bond	Straight
Quantity per pallet	720
Battens per m ²	4.1 m
Batten size - up to 450mm rafter centres	38 x 25 mm
Batten size - up to 600mm rafter centres	50 x 25 mm
Nail size/type for tiles	38 x 3.35 mm aluminium ring shank clout head
Nail size/type for metal tile clips	Integrated with clip

*For projects where the rafters are below 22.5 degrees the roof substructure must be installed in accordance with the Sandtoft low pitch installation guide. Rafter length restrictions apply at minimum roof pitch.

†Clay tiles are subject to small variations in size because of drying and firing shrinkage in the manufacturing process. Before deciding on the batten gauge and linear coverage, the roof tiler should inspect each batch of tiles to ensure that the correct minimum headlap and sidelap are achieved. Unless otherwise stated, data is based on the tiles laid at minimum headlap.

Product specification is subject to change and will be updated accordingly.

Note: Lead times may apply. Colour availability may vary.

Smooth

Natural Red

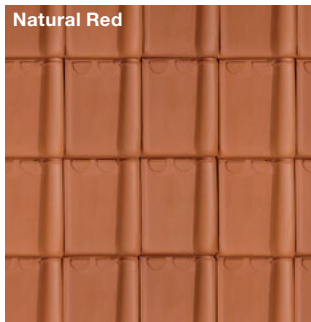

Rustic



Cottage**



Tile Fixing

Sandtoft roof tiles must be laid and fixed to comply with BS 5534: the British Standard Code of practice for slating and tiling, and BS 8000: Part 6: the British Standard Code of practice for workmanship on building sites. To ensure compliance with these standards we strongly recommend that a calculated fixing specification be obtained from Sandtoft Technical Support or using Sandtoft's online All4Roof tool: www.all4roof.co.uk

All4Roof

** Lead times may apply.

Due to the limitations of the printing process and screen calibration settings images shown may not be an accurate representation of the final product colour. Please obtain a sample if unsure.

Fittings

Left Hand Vergé

304 x 237 x 15 mm



Cloaked Vergé

304 x 232 x 108 mm



LH and RH available (LH shown)
Lead times may apply

Accessories

Tile Clip

Nail integrated with clip



Eaves Clip¹

Nail size 20 x 3.35 mm



Verge Clip

Nail size 20 x 3.35 mm



Associated Ridge / Hip

Koramic 325 mm Ridge



Tile Dimensions

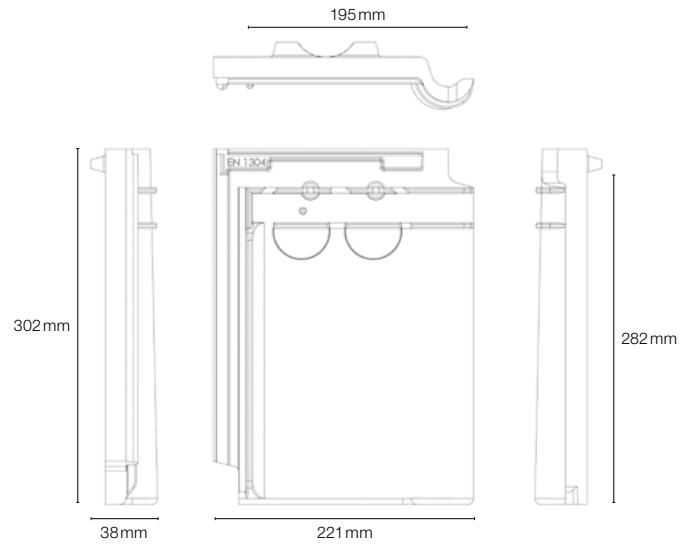

Associated Systems

Additional Systems

10 mm Eaves Ventilation Pack

25 mm Eaves Ventilation Pack

BIM Object
Download



¹ When used in conjunction with Over Fascia Ventilator Strip, nail length should be increased to 40 mm for 10 mm Over Fascia Ventilator Strip, or 50 mm for 25 mm Over Fascia Ventilator Strip.

All dimensions are nominal and taken from the drawing.
Actual product dimensions may vary slightly from those referenced above.

KEYMER

Contents

Goxhill Plain Tile	82-83
Shire Plain Tile	84
Traditional Plain Tile	85
Peg Tile	86
Fittings	87



GOXHILL

Plain Tile

Clay



One of the finest and most distinctive roof coverings available, this premium handmade plain tile gives a rich textured roofscape that will become more attractive with age.

Product Technical Information Sheet

Roof Tiling

Minimum roof pitch	35°
Headlap	65 mm
Batten spacing (fixed gauge) [†]	100 mm
Size of tile [†]	265 x 165 mm
Covering capacity	60 tiles per m ²
Cover width	165 mm
Profile depth	13 mm
Hanging length	245 mm
Weight as laid	72.6 kg per m ²
Weight per 1000 (including pallet and packaging)	1.31 tonnes
Weight per tile	1.21 kg
Weight per pallet (including pallet and packaging)	0.707 tonnes
Bond	Cross / Broken
Quantity per pallet	540
Battens per m ²	10 m
Batten size - up to 600mm rafter centres	38 x 25 mm
Nail size/type for tiles	38 x 3.35 mm aluminium ring shank clout head

Vertical Tiling

Minimum roof pitch	75°
Headlap	38 mm
Batten spacing (fixed gauge) [†]	114 mm
Size of tile [†]	265 x 165 mm
Covering capacity	53 tiles per m ²
Cover width	165 mm
Profile depth	13 mm
Hanging length	245 mm
Weight as laid	64.2 kg per m ²
Weight per 1000 (including pallet and packaging)	1.31 tonnes
Weight per tile	1.21 kg
Weight per pallet (including pallet and packaging)	0.707 tonnes
Bond	Cross / Broken
Quantity per pallet	540
Battens per m ²	8.8 m
Batten size - up to 600mm rafter centres	38 x 25 mm
Nail size/type for tiles	38 x 3.35 mm aluminium ring shank clout head

[†]Clay tiles are subject to small variations in size because of drying and firing shrinkage in the manufacturing process. Before deciding on the batten gauge and linear coverage, the roof tiler should inspect each batch of tiles to ensure that the correct minimum headlap and sidelap are achieved. Unless otherwise stated, data is based on the tiles laid at minimum headlap.

Product specification is subject to change and will be updated accordingly.

Note: Lead times may apply. Colour availability may vary.

Sanded

Autumn Brown



Dark Chestnut

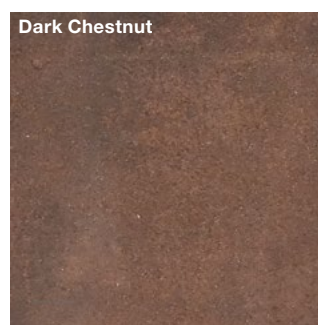

Dark Red



Tile Fixing

Sandtoft roof tiles must be laid and fixed to comply with BS 5534: the British Standard Code of practice for slating and tiling, and BS 8000: Part 6: the British Standard Code of practice for workmanship on building sites. To ensure compliance with these standards we strongly recommend that a calculated fixing specification be obtained from Sandtoft Technical Support or using Sandtoft's online All4Roof tool: www.all4roof.co.uk

All4Roof

Fittings

Eaves Tile

210 x 165 x 13mm



Tile and a Half

265 x 247 x 13mm



Bonnet Hip

270 x 330 x 13mm



Valley Tile

280 x 350 x 13mm



External Angle

265 x 160 x 80mm



Feature Tile (Club)

265 x 165 x 13mm



LH and RH available in both 90° and 135°
(LH 90° shown)

Also available:
Bullnose, Arrowhead & Fishtail

Additional Fittings

Arris Hip (35°, 40°, 45°, 50°)

Internal Angle 90° & 135° (LH & RH)

Accessories

InvisiVent¹

490 x 310mm



Associated Ridge / Hip

Half Round Ridge 305mm



Third Round Ridge 305mm



Tile Dimensions

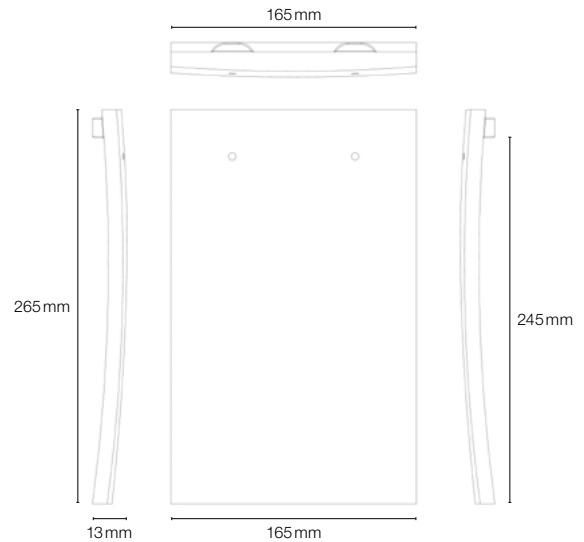

Associated Systems

Additional Systems

3 Piece Bat Tile

10mm Eaves Ventilation Pack

25mm Eaves Ventilation Pack

Top Abutment Ventilator Kit

BIM Object
Download



SHIRE

Plain Tile

Clay



Testament to over 400 years of manufacturing excellence, our Shire tiles range offers authentic British premium handmade clay roof tiles with lifelong durability. These Shire tiles offer a serious alternative to the traditional style of clay roof tiles.

Product Technical Information Sheet

Roof Tiling

Minimum roof pitch	40°
Headlap	65 mm
Batten spacing (fixed gauge) [†]	100 mm
Size of tile [†]	265 x 165 mm
Covering capacity	60 tiles per m ²
Cover width	165 mm
Profile depth	13 mm
Hanging length	245 mm
Weight as laid	73.2 kg per m ²
Weight per 1000 (including pallet and packaging)	1.3 tonnes
Weight per tile	1.22 kg
Weight per pallet (including pallet and packaging)	0.715 tonnes
Bond	Cross / Broken
Quantity per pallet	550
Battens per m ²	10 m
Batten size - up to 600mm rafter centres	38 x 25 mm
Nail size/type for tiles	38 x 3.35 mm aluminium ring shank clout head

Vertical Tiling

Minimum roof pitch	75°
Headlap	38 mm
Batten spacing (fixed gauge) [†]	114 mm
Size of tile [†]	265 x 165 mm
Covering capacity	53 tiles per m ²
Cover width	165 mm
Profile depth	13 mm
Hanging length	245 mm
Weight as laid	64.7 kg per m ²
Weight per 1000 (including pallet and packaging)	1.3 tonnes
Weight per tile	1.22 kg
Weight per pallet (including pallet and packaging)	0.715 tonnes
Bond	Cross / Broken
Quantity per pallet	550
Battens per m ²	8.8 m
Batten size - up to 600mm rafter centres	38 x 25 mm
Nail size/type for tiles	38 x 3.35 mm aluminium ring shank clout head

[†]Clay tiles are subject to small variations in size because of drying and firing shrinkage in the manufacturing process. Before deciding on the batten gauge and linear coverage, the roof tiler should inspect each batch of tiles to ensure that the correct minimum headlap and sidelap are achieved. Unless otherwise stated, data is based on the tiles laid at minimum headlap.

Product specification is subject to change and will be updated accordingly.

Note: Lead times may apply. Colour availability may vary.

Sanded

Downs Red



Heritage

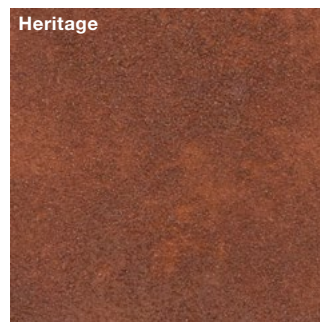

Priory



Tile Fixing

Sandtoft roof tiles must be laid and fixed to comply with BS 5534: the British Standard Code of practice for slating and tiling, and BS 8000: Part 6: the British Standard Code of practice for workmanship on building sites. To ensure compliance with these standards we strongly recommend that a calculated fixing specification be obtained from Sandtoft Technical Support or using Sandtoft's online All4Roof tool: www.all4roof.co.uk

All4Roof



TRADITIONAL

Plain Tile

Clay

Our traditional clay plain tiles are hand made using Weald Clay. The rich reds of the clay give them their deep natural colour. The tiles do not all sit flat next to each other in total conformity but in gentle undulations reminiscent of a centuries old cottage.

Product Technical Information Sheet

Roof Tiling	
Minimum roof pitch	40°
Headlap	65 mm
Batten spacing (fixed gauge) [†]	100 mm
Size of tile [†]	265 x 165 mm
Covering capacity	60 tiles per m ²
Cover width	165 mm
Profile depth	13 mm
Hanging length	245 mm
Weight as laid	73.2 kg per m ²
Weight per 1000 (including pallet and packaging)	1.3 tonnes
Weight per tile	1.22 kg
Weight per pallet (including pallet and packaging)	0.988 tonnes
Bond	Cross / Broken
Quantity per pallet	760
Battens per m ²	10 m
Batten size - up to 600mm rafter centres	38 x 25 mm
Nail size/type for tiles	38 x 3.35 mm aluminium ring shank clout head

Vertical Tiling	
Minimum roof pitch	75°
Headlap	38 mm
Batten spacing (fixed gauge) [†]	114 mm
Size of tile [†]	265 x 165 mm
Covering capacity	53 tiles per m ²
Cover width	165 mm
Profile depth	13 mm
Hanging length	245 mm
Weight as laid	64.7 kg per m ²
Weight per 1000 (including pallet and packaging)	1.3 tonnes
Weight per tile	1.22 kg
Weight per pallet (including pallet and packaging)	0.988 tonnes
Bond	Cross / Broken
Quantity per pallet	760
Battens per m ²	8.8 m
Batten size - up to 600mm rafter centres	38 x 25 mm
Nail size/type for tiles	38 x 3.35 mm aluminium ring shank clout head

[†]Clay tiles are subject to small variations in size because of drying and firing shrinkage in the manufacturing process. Before deciding on the batten gauge and linear coverage, the roof tiler should inspect each batch of tiles to ensure that the correct minimum headlap and sidelap are achieved. Unless otherwise stated, data is based on the tiles laid at minimum headlap.

Product specification is subject to change and will be updated accordingly.

Note: Lead times may apply. Colour availability may vary.

Sanded

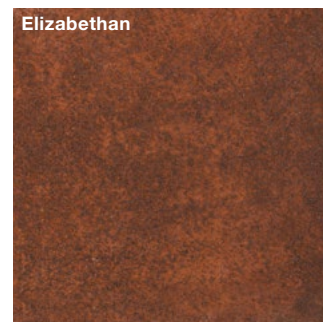
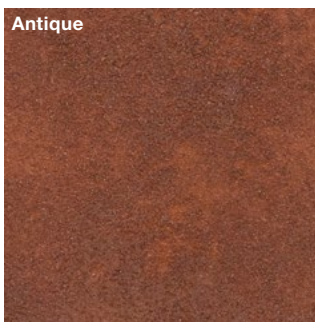

Tile Fixing

Sandtoft roof tiles must be laid and fixed to comply with BS 5534: the British Standard Code of practice for slating and tiling, and BS 8000: Part 6: the British Standard Code of practice for workmanship on building sites. To ensure compliance with these standards we strongly recommend that a calculated fixing specification be obtained from Sandtoft Technical Support or using Sandtoft's online All4Roof tool: www.all4roof.co.uk



PEG TILE Clay



Crafted from the famous Keymer South Wealden Clay, each tile produces a unique finish that is guaranteed to set your roof apart.

Product Technical Information Sheet

Roof Tiling	
Minimum roof pitch	40°
Headlap	60 mm
Batten spacing (fixed gauge) [†]	95 mm
Size of tile [†]	250 x 150 mm
Covering capacity	70.2 tiles per m ²
Cover width	150 mm
Profile depth	13 mm
Hanging length	230 mm
Weight as laid	84.3 kg per m ²
Weight per 1000 (including pallet and packaging)	1.24 tonnes
Weight per tile	1.2 kg
Weight per pallet (including pallet and packaging)	0.939 tonnes
Bond	Cross / Broken
Quantity per pallet	760
Battens per m ²	10.6 m
Batten size - up to 600mm rafter centres	38 x 25 mm
Nail size/type for tiles	38 x 3.35 mm aluminium ring shank clout head

Vertical Tiling

Peg Tiles are a traditional product and therefore are not manufactured to a British Standard. When vertical tiling please contact your local conservation officer regarding installation information.

[†]Clay tiles are subject to small variations in size because of drying and firing shrinkage in the manufacturing process. Before deciding on the batten gauge and linear coverage, the roof tiler should inspect each batch of tiles to ensure that the correct minimum headlap and sidelap are achieved. Unless otherwise stated, data is based on the tiles laid at minimum headlap.

Product specification is subject to change and will be updated accordingly.

Note: Lead times may apply. Colour availability may vary.

Sanded

Antique

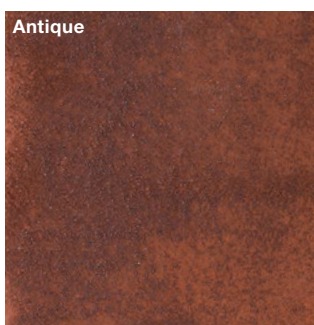

Weathered (County)

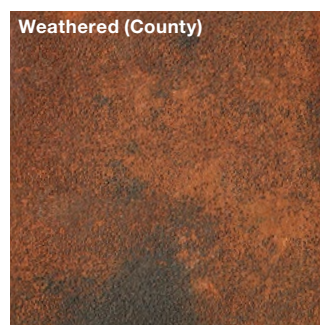

Tile Fixing

For information regarding tile fixing please contact the Heritage team.

Keymer manufacture the largest range of handmade clay fittings you'll find. The true skill of the Keymer master tile maker is well displayed, from the valley to the ridge. Using wealden clay, these fittings are not only the natural choice in conservation areas but also add character and value to any new building too.

Fittings

Ridge

Plain Tile

265 x 165 mm

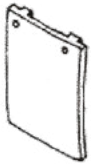

Eaves Tile

200 x 165 mm



Gable Tile

265 x 248 mm

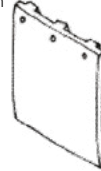

Half Round

305 x 180 x 90 mm

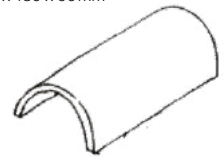

Peg Tile (Kent or County)

250 x 150 mm



Peg Eaves

150 x 150 mm



Peg Gable

250 x 225 mm

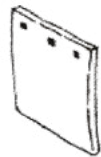

Hogback

305 x 235 x 125 mm

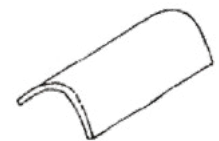

Standard Bonnet

40°- 50°



Traditional Bonnet

40°- 45°

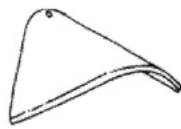

Made to order

Kent Bonnet

50°- 60°

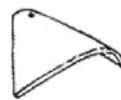

Made to order

Third Round

305 mm



Standard Valley

40°- 50°



Gull Wing Valley (Cambered)

40°- 45°



Made to order

60° Valley

50°- 60°



Made to order

Monopitch Ridge

305 mm

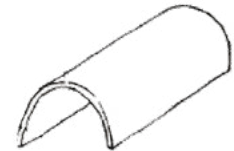

3 Piece Bat Vent

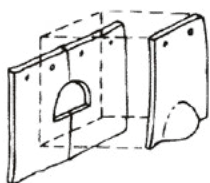

Vertical Angle 90° (Handed)

External



Vertical Bay Angle 135° (Handed)

External



Porch Ridge

305 mm



RIDGE

Contents

Concrete Ridge	90-91
Concrete Decorative Ridge	92-93
Clay Ridge	94-95
Duracoat® Ridge	96-97
Clay Decorative Ridge	98-99



RIDGE

Concrete



Half Round Ridges

Half Round Ridge

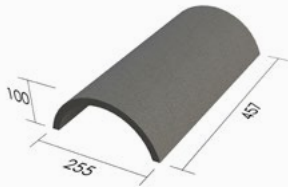

Half Round Ridge with Block End

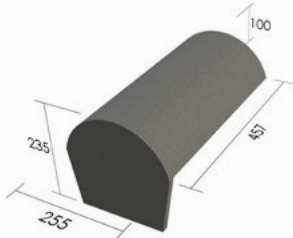

Half Round Ridge with Gable Stop End

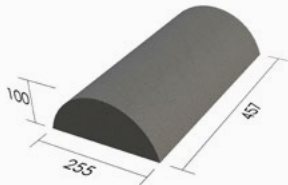

Made to order

Half Round Ridge with Hip End

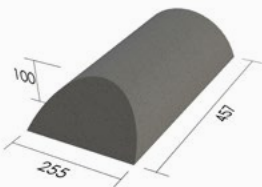

Made to order

Segmental Ridges

Segmental Ridge

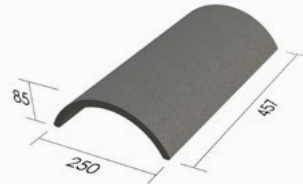

Segmental Ridge with Block End

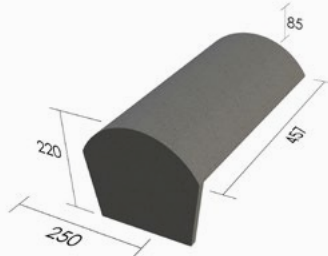

Made to order

Segmental Ridge with Gable Stop End

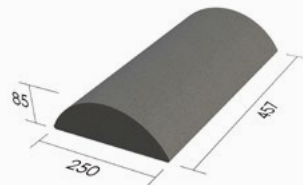

Made to order

Segmental Ridge with Hip End

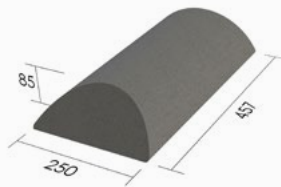

Made to order

Segmental Hip Starter Ridge

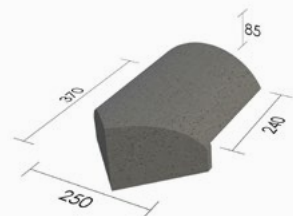

Multi Angle Ridges

Multi Angle Ridge

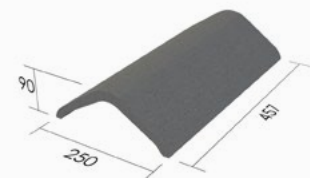

Smooth only

Multi Angle Ridge with Block End

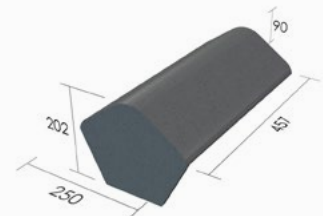

Smooth only

Multi Angle Ridge with Gable Stop End

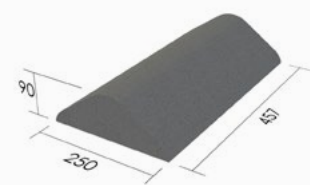

Made to order

Multi Angle Ridge with Hip End

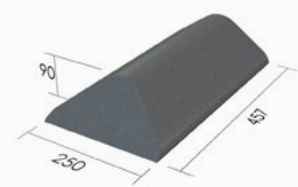

Made to order

Multi Angle Hip Starter Ridge

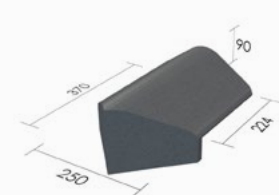

Smooth only

Half Round Mono Ridges

Half Round Mono Ridge



Multi Angle Mono Ridges

Multi Angle Mono Ridge

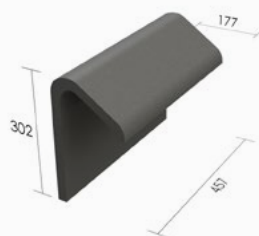

Smooth only

Specialist Ridges

Capped Angle Ridge 105°

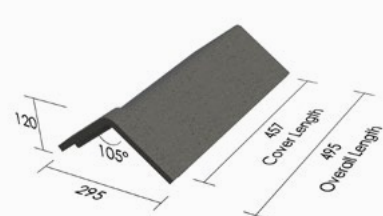

Smooth only

Half Round Ridge with Block End

Left and right hand versions available (LH shown).

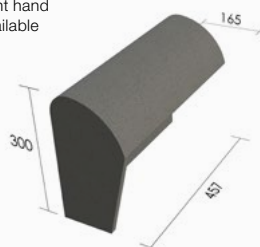

Multi Angle Mono Ridge with Block End

Left and right hand versions available (LH shown).

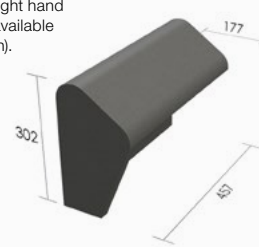

Smooth only

Baby Ridge

For use on bay windows only.



Maximum pitches

Half Round Ridge Max Roof Pitches

	Profile Ridge	Roll Ridge	Mortar Bedded
Plain Tile	50°	50°	50°
Lindum	50°	50°	55°
Standard Pattern	50°	50°	55°
Shire Pantile	50°	50°	60°
Double Roman	50°	50°	60°
Double Pantile	50°	50°	60°

Multi Angle Ridge Max Roof Pitches

	Profile Ridge	Roll Ridge	Mortar Bedded
Calderdale Edge	45°	45°	50°
Dual Calderdale Edge	45°	45°	50°
TLE	45°	45°	50°
Dual TLE	45°	45°	50°

DECORATIVE RIDGE

Concrete



A variety of ridge profiles are available with different end pieces and decorative crests and/or finials. The ridges are named by their elements in the order set out below.

Decorative Ridge Diagram

Element Order

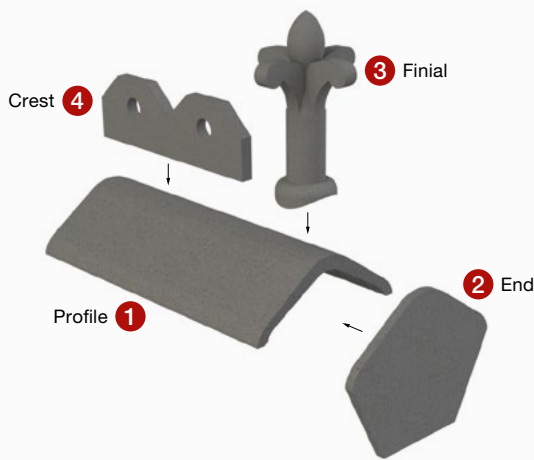

Made to order (Terracotta Red & Dark Grey only)

Please note that when combining a finial with a crest on a decorative ridge, the crest design is adjusted to accommodate the finial. For example, a three hole crest will become a two hole crest as illustrated.

With all decorative ridge orders there is a 72 hour cancellation period from receipt of order acknowledgement. After which time, any changes made would incur a 50% cancellation fee.

Step 1 Profiles

Half Round

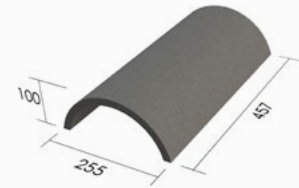

Multi Angle

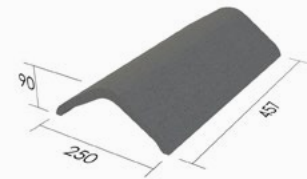

Step 2 Ends

Block End Ridge

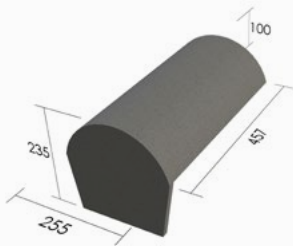

Gable Stop End

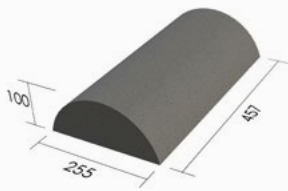

Hip End

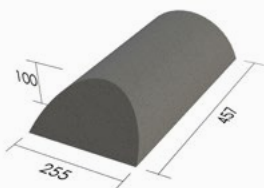

Step 3 Crests

Club Crest



Cockscomb Crest



Three Hole Crest



Fleur-de-lys Crest



Step 4 Finials

Scroll Finial



Available in 1 height: 140mm

Fleur-de-lys Finial



Available in 2 heights: Short (270mm), or Tall (370mm)

Ball Finial



Available in 2 heights: Short (240mm), or Tall (340mm)

RIDGE

Clay



Half Round Ridges

Half Round Ridge

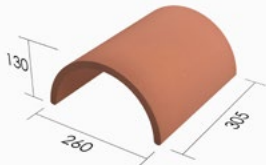

Angle Ridges

Angle Ridge

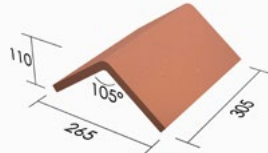

Smooth only

Handmade Ridges

Half Round Sanded Handmade Ridge

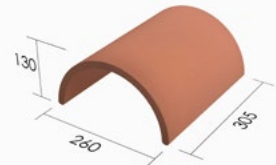

Half Round Ridge with Block End

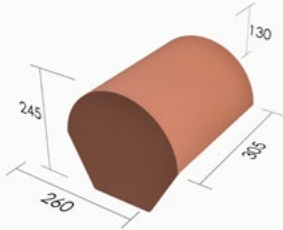

Smooth only

Angle Ridge with Block End

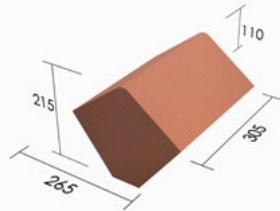

Smooth only / Made to order

Third Round Sandfaced Handmade Ridge

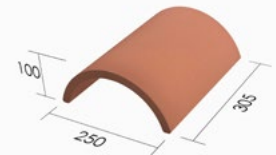

Half Round Ridge with Gable Stop End

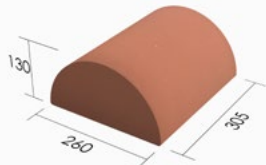

Smooth only / Made to order

Angle Ridge with Gable Stop End

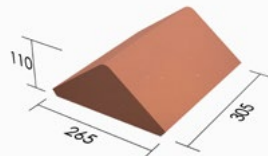

Smooth only / Made to order

Hogsback Ridge

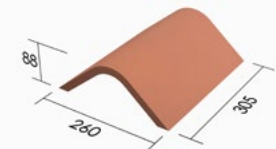

Half Round Ridge with Hip End

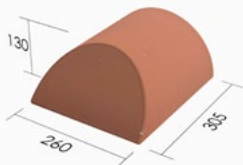

Smooth only / Made to order

Angle Ridge with Hip End

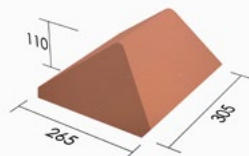

Smooth only / Made to order

Half Round Koramic Ridges

Koramic 325mm Ridge

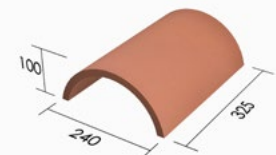

Half Round Mono Ridges

Half Round Mono Ridge

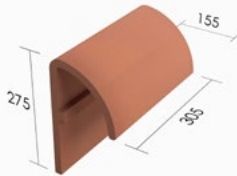

Third Round Ridges

Third Round Ridge

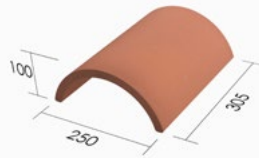

Specialist Clay Ridges

Capped Angle Ridge 105°

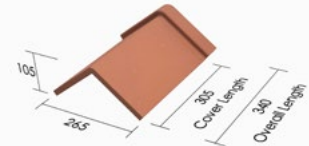

Smooth only

Half Round Ridge with Block End

Left and right hand versions available (LH shown).

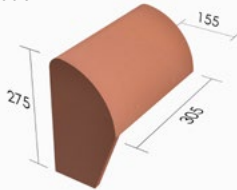

Smooth only

Third Round Hip Starter Ridge

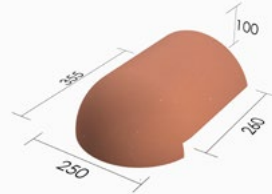

Smooth only

Baby Ridge

For use on bay windows only.

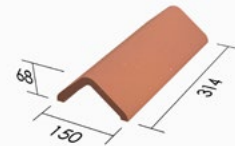

Maximum pitches

Half Round Ridge Max Roof Pitches

	Profile Ridge	Roll Ridge	Mortar Bedded
Humber PT	50°	50°	60°
Humber PT Sandfaced	50°	N/A	60°
Village PT	50°	50°	60°
Alban	50°	N/A	60°
Barrow	50°	N/A	60°
Neo Plus	50°	50°	60°
Old English	N/A	N/A	60°
Arcadia	N/A	N/A	60°
New County	45°	N/A	70°
Bridgwater	N/A	N/A	65°
Gaelic	N/A	N/A	65°

Koramic 325mm Ridge Max Roof Pitches

	Profile Ridge	Roll Ridge	Mortar Bedded
301	50°	N/A	50°
303	50°	N/A	50°
Old Hollow 451	N/A	N/A	40°
Tempest 44	N/A	N/A	50°



Half Round Ridges

Half Round Ridge

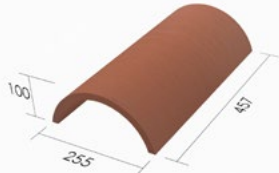

Half Round Ridge with Block End

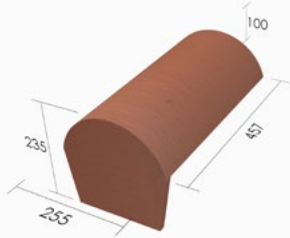

Half Round Ridge with Gable Stop End

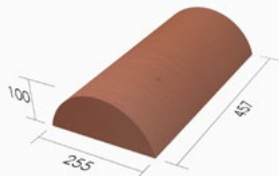

Made to order

Half Round Ridge with Hip End

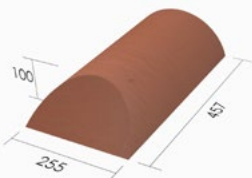

Made to order

Segmental Ridges

Segmental Ridge

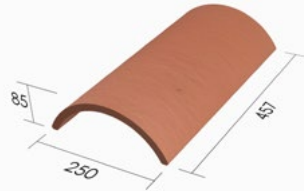

Segmental Ridge with Block End

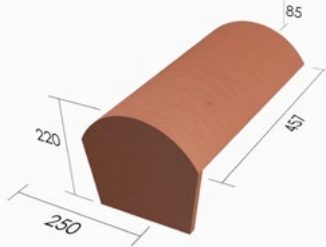

Made to order

Segmental Ridge with Gable Stop End

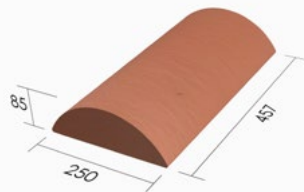

Made to order

Segmental Ridge with Hip End

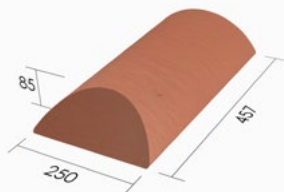

Made to order

Segmental Hip Starter Ridge

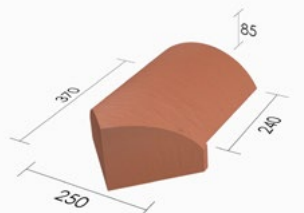

Multi Angle Ridges

Multi Angle Ridge

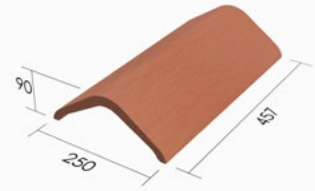

Multi Angle Ridge with Block End

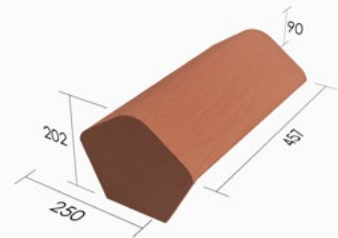

Multi Angle Ridge with Gable Stop End

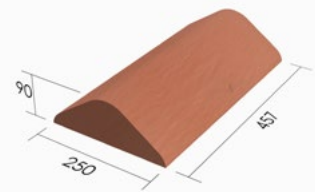

Made to order

Multi Angle Ridge with Hip End

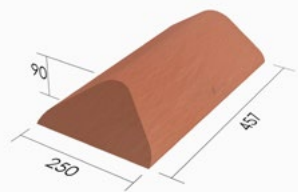

Made to order

Multi Angle Hip Starter Ridge

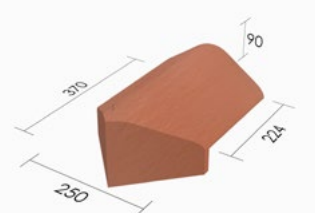

Half Round Mono Ridges

Half Round Mono Ridge

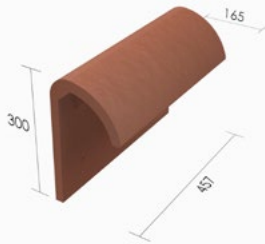

Multi Angle Mono Ridges

Multi Angle Mono Ridge

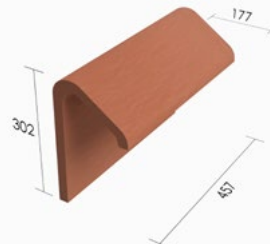

Specialist Ridges

Baby Ridge

For use on bay windows only.

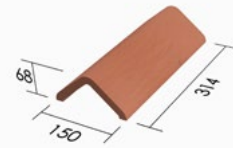

Half Round Ridge with Block End

Left and right hand versions available (LH shown).

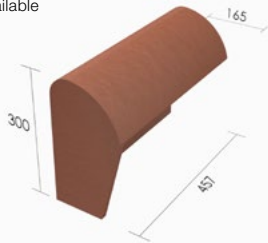

Made to order

Multi Angle Mono Ridge with Block End

Left and right hand versions available (LH shown).

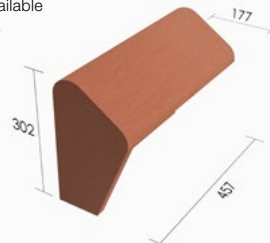

Made to order

Maximum pitches

Half Round Ridge Max Roof Pitches

	Profile Ridge	Roll Ridge	Mortar Bedded
20/20	50°	50°	50°
Vauban	50°	50°	55°
Modula	N/A	50°	50°
Olympus	50°	50°	60°

Multi Angle Ridge Max Roof Pitches

	Profile Ridge	Roll Ridge	Mortar Bedded
Cassius	45°	45°	50°
Rivius	45°	45°	50°
Actua	45°	35°	40°

DECORATIVE RIDGE

Clay



A variety of ridge profiles are available with different end pieces and decorative crests and/or finials in both clay and Duracoat®. The ridges are named by their elements in the order set out below.

Decorative Ridge Diagram

Element Order

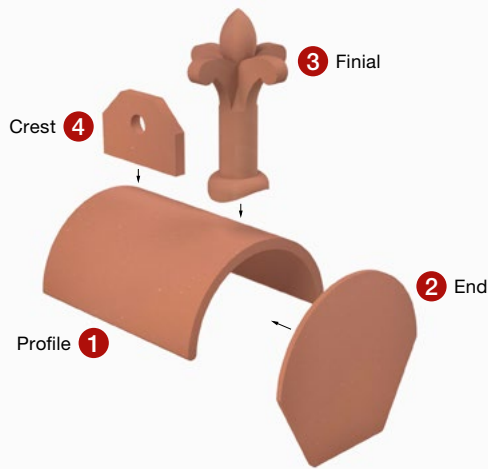

Made to order (Smoothfaced colours only)

Please note that when combining a finial with a crest on a decorative ridge, the crest design is adjusted to accommodate the finial. For example, a clay two hole crest will become a single hole crest as illustrated.

With all decorative ridge orders there is a 72 hour cancellation period from receipt of order acknowledgement. After which time, any changes made would incur a 50% cancellation fee.

Step 1 Profiles

Half Round

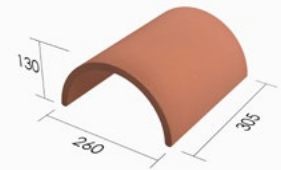

105 Angle Ridge

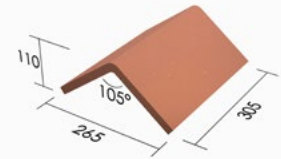

Step 2 Ends

Block End Ridge

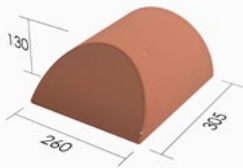

Gable Stop End

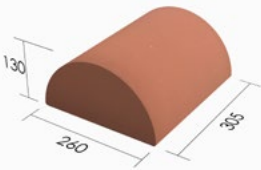

Hip End

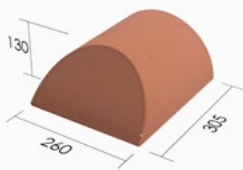

Step 3 Crests

Club Crest



Cockscomb Crest



Hole Crest



Step 4 Finials

Scroll Finial



Available in 1 height: 140mm

Fleur-de-lys Finial



Available in 2 heights: Short (270mm), or Tall (370mm)

Ball Finial



Available in 2 heights: Short (240mm), or Tall (340mm)

ROOFING SYSTEMS

Contents

Underlays	102
TLE / Medium Format Dry Verge	103
Multiverge	104
Roll Ridge	105
Roll Hip	106
Multiversal Ridge and Hip	107
Profile Ridge	108
Profile Mono Ridge	109
In-Line Tile Ventilators	110
Cowl Ventilators	111
Plain Tile InvisiVent	112
Eaves Ventilation System	113
Top Abutment Ventilator	114
Lead Replacement	115
Mortarless Bonding Gutter	116
Universal Dry Valley	117

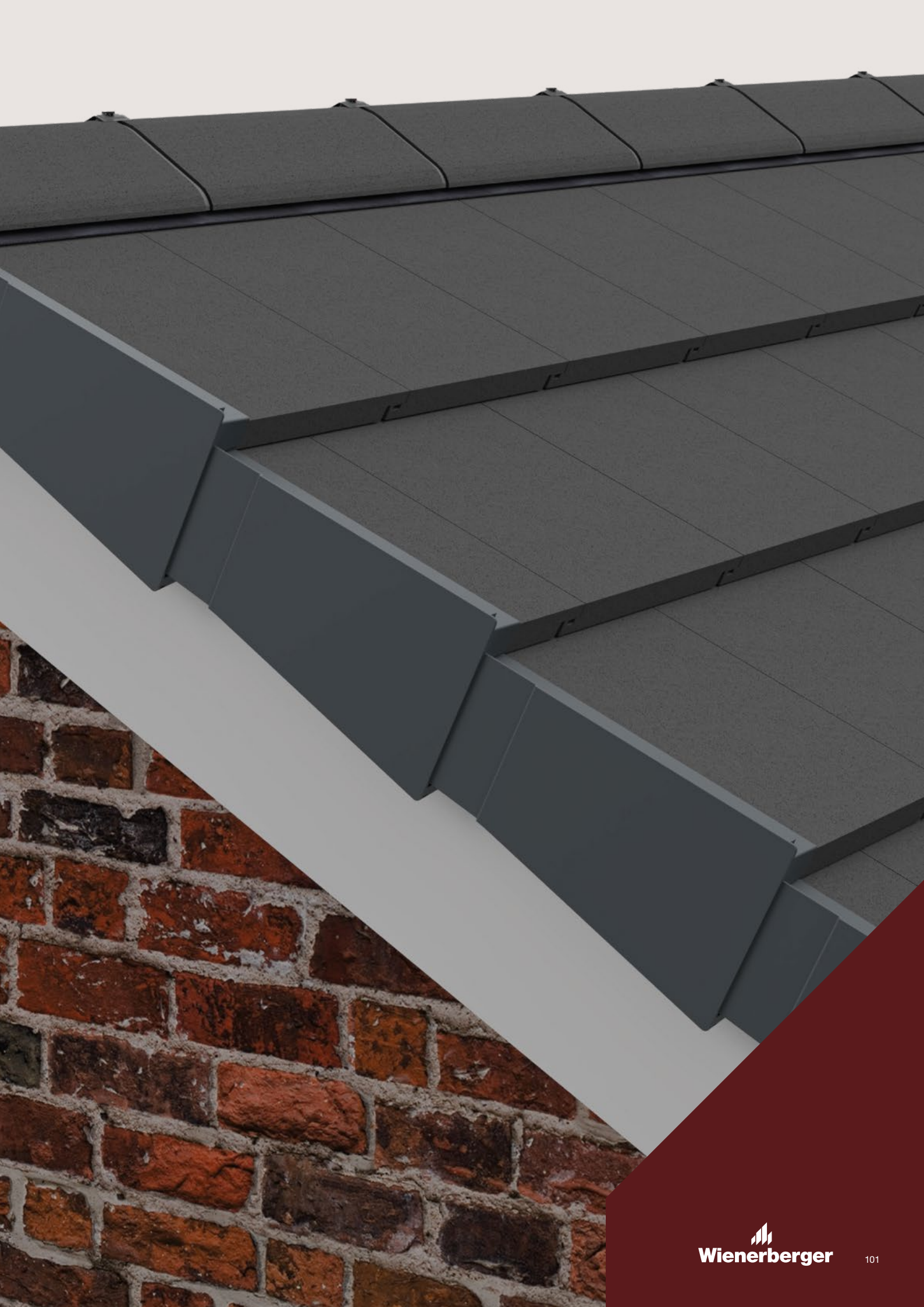



Sandtoft VPM Classic and Sandtoft VPM Super can be used with all concrete and clay roof tiles and slates and are suitable for both warm and cold roof designs on any roof shape and building type.

Product Technical Information Sheet

	Sandtoft Super VPM	Sandtoft Classic VPM	Sandtoft Classic Taped VPM
Roll Size	50m x 1.0m (50m ²)	50m x 1.0m (50m ²)	50m x 1.0m (50m ²)
Weight	160 (-10/+18)gsm	130 (+/-5)gsm	130 (+/-5)gsm
Resistance to water penetration	Before and After artificial ageing: Class W1	Before and After artificial ageing: Class W1	Before and After artificial ageing: Class W1
Flexibility at low temperature	-40°C	-40°C	-40°C
Water vapour resistance	≤0.15 (-0.05/+0.1) MNs/g	≤0.15 MNs/g	≤0.15 MNs/g
Equivalent air layer thickness	≤0.03 (-0.01/+0.02)sd(m)	≤0.03sd(m)	≤0.03sd(m)
Reaction to fire	(NPD)	(NPD)	(NPD)

Product Image



Guidance

Product specification is subject to change and will be updated accordingly.

Both membranes perform all the usual functions of a good quality roof underlay; i.e. they act as a secondary line of defence against wind driven rain and snow, they reduce the wind loading on the roof tiles and slates and act as a temporary roof covering during building construction. These membranes also provide many benefits over the traditional bitumen-based underlays; in particular they help avoid condensation in the roof space.



Wind Uplift Performance

Sandtoft Super VPM

Batten Gauge ≤ 310mm
Rafter Centres ≤ 600mm



Batten Gauge ≤ 345mm
Rafter Centres ≤ 600mm



Sandtoft Classic VPM

Batten Gauge ≤ 310mm
Rafter Centres ≤ 600mm



Batten Gauge ≤ 345mm
Rafter Centres ≤ 600mm



Sandtoft Classic Taped VPM

Batten Gauge ≤ 310mm
Rafter Centres ≤ 600mm



Batten Gauge ≤ 345mm
Rafter Centres ≤ 600mm



The Sandtoft TLEMF Dry Verge system comprises left and right hand verges, is easy to use and provides a neat, secure and mortarless finish at roof verges.

Product Technical Information Sheet

General Information

Minimum roof pitch	Suits the minimum roof pitch of all compatible tiles
Gauge	295 - 345 mm
Gauge (with vertical batten installed)	210 - 345 mm
Size of unit	420 x 128 x 44 mm
Colours	Dark Grey/Antique Slate
	Red Multi
	Tuscan
	Natural Red
Primary fixing (supplied)	35 x 4 mm screw
Secondary eaves fixing (not supplied)	Minimum 45mm length screw
Box quantity	50
Material	HIPS

Tile Compatibility

20/20	Dual TLE	TLE
Cassius	Rivius	

Colours

Brown



Natural Red



Red Multi



Tuscan



Guidance

Product specification is subject to change and will be updated accordingly.

Used in conjunction with: TLE/MF Eaves Unit (p122), Ridge End Cap (p122), Ridge Closure Comb (p122), Ridge Blockend (p90)

Product Image

Dark Grey/Antique Slate



Verge unit pictured with Ridge Closure Comb

Technical Drawing

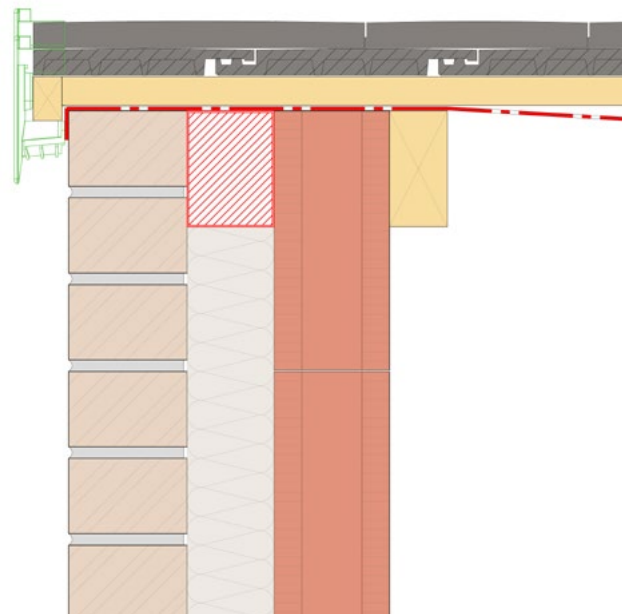

MULTIVERGE

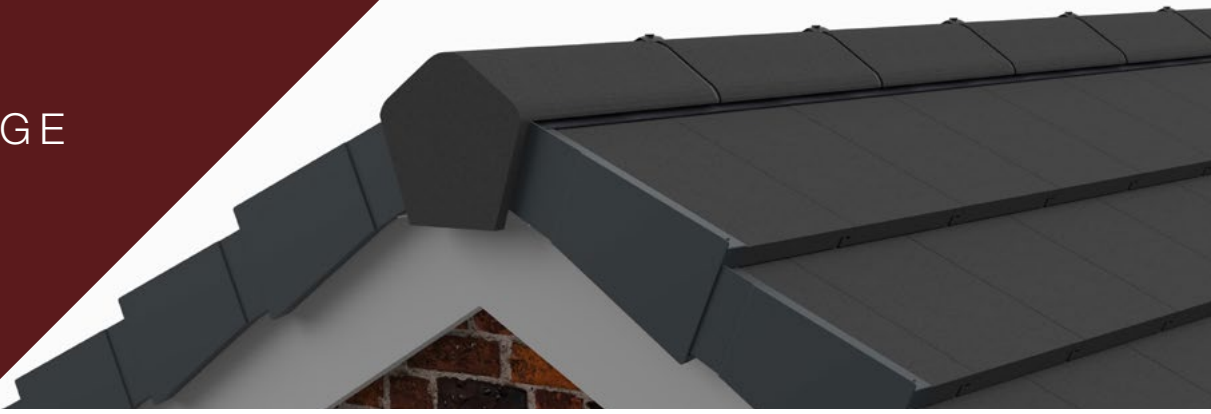

The Sandtoft Multiverge system comprises left and right hand verges, is easy to use and provides a neat, secure and mortarless finish at roof verges.

Product Technical Information Sheet

General Information

Minimum roof pitch	Suits the minimum roof pitch of all compatible tiles
Gauge	280 - 345 mm
Gauge (with vertical batten installed)	260 - 345 mm
Size of unit	420 x 178 x 46 mm
Colours	Dark Grey/Antique Slate
	Red Multi
	Natural Red
	Brown
Primary fixing (supplied)	35 x 4 mm screw
Secondary eaves fixing (not supplied)	Minimum 60mm length screw
Box quantity	50
Material	HIPS

Tile Compatibility

Calderdale Edge	Dual Calderdale Edge	Rivius
Cassius	Dual TLE	TLE
Double Pantile	Lindum	
Double Roman	Olympus	

Tile Compatibility (Medium Format)

Neo Plus	Shire Pantile	Standard Pattern
----------	---------------	------------------

Colours

Brown



Dark Grey/Antique Slate



Natural Red

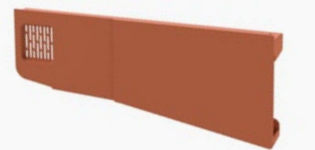

Red Multi



Guidance

Product specification is subject to change and will be updated accordingly.

Available in colours to complement the roof tiles.

Used in conjunction with: Multiverge Eaves Unit (p122), Ridge End Cap (p122), Ridge Closure Comb (p122), Ridge Blockend (p90)

Product Image

Natural Red



Eave/Verge units pictured with Ridge Closure Comb

Technical Drawing

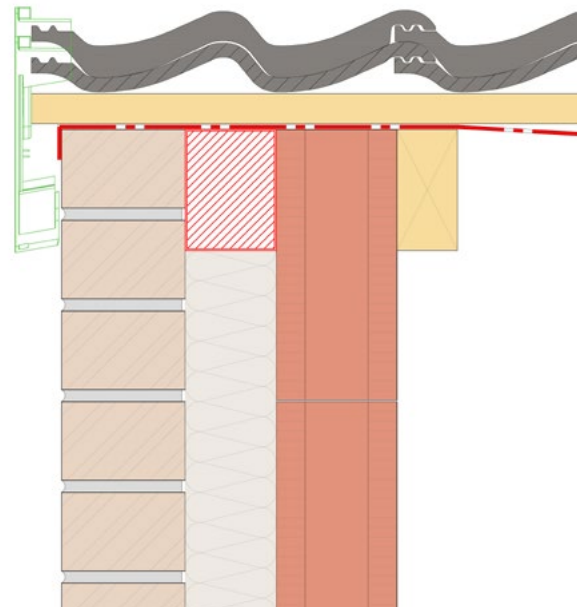

Sandtoft Roll Ridge is an extremely quick roll out system that uses the minimum of components.

Product Technical Information Sheet

General Information

Size of Pack	380 mm (L) x 190 mm (W) x 320 mm (H)
Component quantities	To suit 6 metres of ridge
Roll material	Aluminium & Butyl
Joint material	PP
Hip Strap material	Iron Galvanised
Fixing Plate material	Stainless Steel
Screw material	Stainless Steel + rubber washer

Tile Compatibility*

20/20	Dual Calderdale Edge	Rivius
Actua	Dual TLE	Shire Pantile
Calderdale Edge	Humber Plain Tile	Standard Pattern
Cassius	Lindum	TLE
Concrete Plain Tile	Modula	Vauban
Double Pantile	Neo Plus	
Double Roman	Olympus	

Ridge Compatibility

Clay Half Round Ridge	305 mm
Concrete Half Round Ridge	457 mm
Concrete Multi Angle Ridge	457 mm ¹
Duracoat Half Round Ridge	457 mm
Duracoat Multi Angle Ridge	457 mm

Guidance

Product specification is subject to change and will be updated accordingly.

The system comprises a ventilated 6m ridge roll, batten straps to secure the ridge timber and ridge joints with fixings.

Product Image



Technical Drawing

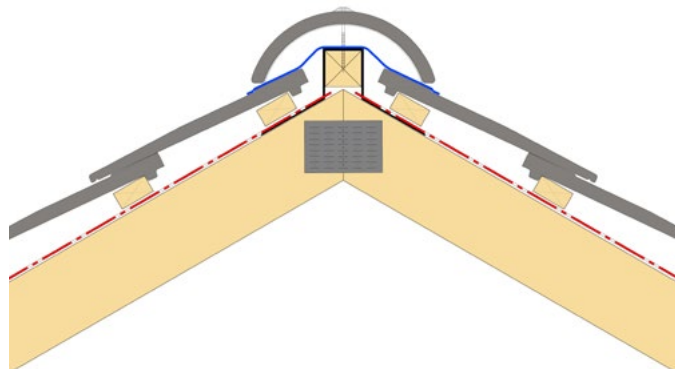

¹ The multi Angle Roll Ridge system is also suitable for use on the hip.

*It is suitable for use with most clay and concrete tiles and slates (except Sanded tiles).

ROLL HIP

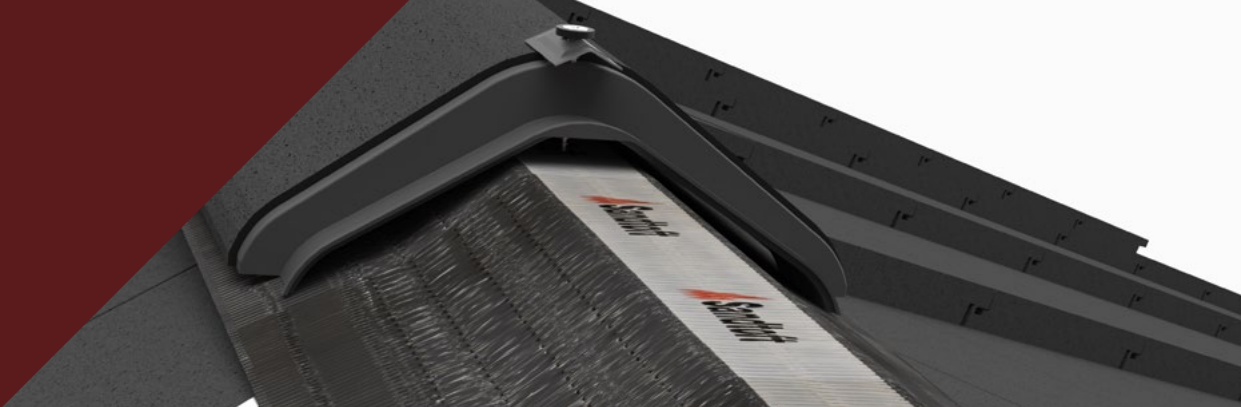

Sandtoft Roll Hip is an extremely quick roll out system. Roll Hip comprises a ventilated hip roll to seal the junction between roof elevations and trays to support the hip ridges.

Product Technical Information Sheet

General Information

Size of Pack	380 mm (L) x 190 mm (W) x 320 mm (H)
Component quantities	To suit 6 metres of hip
Roll material	Aluminium & Butyl
Joint material	PP
Hip Strap material	Iron Galvanised
Fixing Plate material	Stainless Steel
Screw material	Stainless Steel + rubber washer

Tile Compatibility*

20/20	Dual Calderdale Edge	Rivius
Actua	Dual TLE	Shire Pantile
Calderdale Edge	Humber Plain Tile	Standard Pattern
Cassius	Lindum	TLE
Concrete Plain Tile	Modula	Vauban
Double Pantile	Neo Plus	
Double Roman	Olympus	

Ridge Compatibility

Clay Half Round Ridge	305 mm
Concrete Half Round Ridge	457 mm
Concrete Multi Angle Ridge	457 mm ¹
Duracoat Half Round Ridge	457 mm
Duracoat Multi Angle Ridge	457 mm

Guidance

Product specification is subject to change and will be updated accordingly.

Hip unions are available to suit most Sandtoft concrete, Duracoat and clay hip profiles and provide an efficient seal between each hip ridge, giving the appearance of a 10 mm mortar joint.

Product Image



Technical Drawing

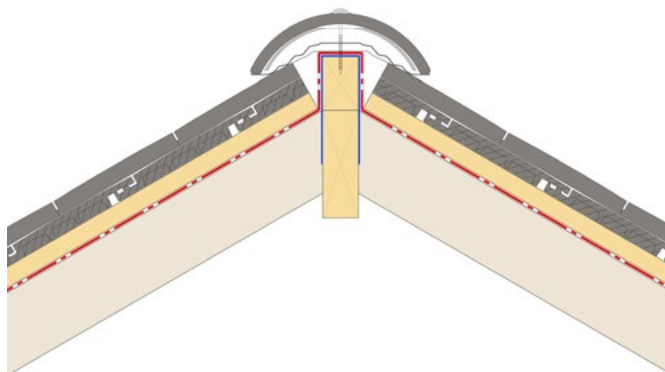

*Please note: The Roll Hip System is not suitable for tile colours with a sanded finish.

¹ The Multi Angle Roll Hip system is also suitable for use on the ridge.

MULTIVERSAL RIDGE AND HIP

The Multiversal Ridge and Hip system is a low cost, easy and quick way to install system providing a secure and mortar-free fix solution at ridge and hip.

Product Technical Information Sheet

General Information

Size of Pack	380 mm (L) x 190 mm (W) x 320 mm (H)
Component quantities	To suit 6 metres of ridge or hip
Roll material	Aluminium & Butyl
Joint material	PP
Hip Strap material	Iron Galvanised
Fixing Plate material	Stainless Steel
Screw material	Stainless Steel + rubber washer

Tile Compatibility*

20/20	Dual Calderdale Edge	Rivius
Actua	Dual TLE	Shire Pantile
Calderdale Edge	Humber Plain Tile	Standard Pattern
Cassius	Lindum	TLE
Concrete Plain Tile	Modula	Vauban
Double Pantile	Neo Plus	
Double Roman	Olympus	

Ridge Compatibility

Clay Third Round Ridge	305mm
Concrete Half Round Ridge	457mm
Concrete Segmental Ridge	457mm
Concrete Multi Angle Ridge	457mm
Duracoat Segmental Ridge	457mm
Duracoat Half Round Ridge	457mm
Duracoat Multi Angle Ridge	457mm

Guidance

Product specification is subject to change and will be updated accordingly.

The Sandtoft Multiversal ridge & hip system is a low cost, easy and quick to install system providing a secure and dry fix solution. The system is suitable for most slates, flat tiles, profile tiles and can be used with most common ridge and hip tiles.

For further guidance, download the Multiversal Ridge & Hip - 6m Installation Guide.

Product Image



Technical Drawing

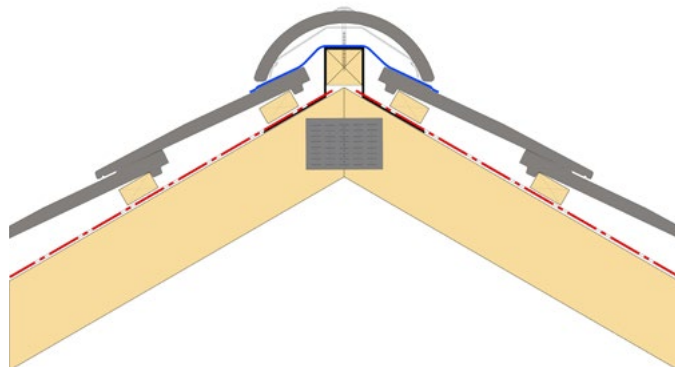

* Please note: The Multiversal Ridge & Hip System is not suitable for tile colours with a sanded finish.

PROFILE RIDGE

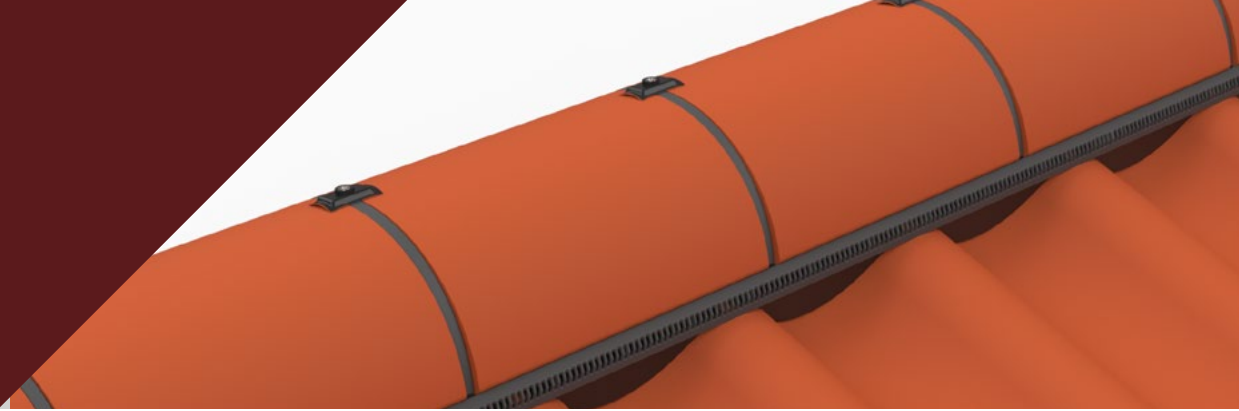

The Profile Ridge system incorporates ventilation strips to support the ridges and provide high level ventilation.

Product Technical Information Sheet

General Information

Size of Pack	1040mm (L) x 230mm (W) x 170 mm (H)
Component quantities	To suit 6 metres of ridge
Profile Dry Ridge Ventilation Strip material	PP
Joint material	PP
Hip Strap material	Iron Galvanised
Fixing Plate material	Stainless Steel
Screw material	Stainless Steel + rubber washer

Tile Compatibility (Flat Tiles)

20/20	Dual Calderdale Edge	TLE
Actua	Dual TLE	Vauban
Calderdale Edge	Plain Tiles (All)	
Cassius	Rivius	

Tile Compatibility (Profiled Tiles) *

Double Pantile	Neo Plus	Shire Pantile
Double Roman	New County	Standard Pattern
Lindum	Olympus	

Ridge Compatibility

Clay Half Round Ridge	305 mm
Clay Koramic Ridge	325 mm
Concrete Half Round Ridge	457 mm
Concrete Multi Angle Ridge	457 mm
Duracoat Half Round Ridge	457 mm
Duracoat Multi Angle Ridge	457 mm

Guidance

Product specification is subject to change and will be updated accordingly.

Ridge joints provide an efficient seal between each ridge and give the appearance of a 10mm mortar joint.

To complete the system, and to enhance aesthetics, profile fillers are available for profiled tile types. The fillers click into the ventilation strips and both are marked to ensure correct orientation (p121).

Product Image



Technical Drawing

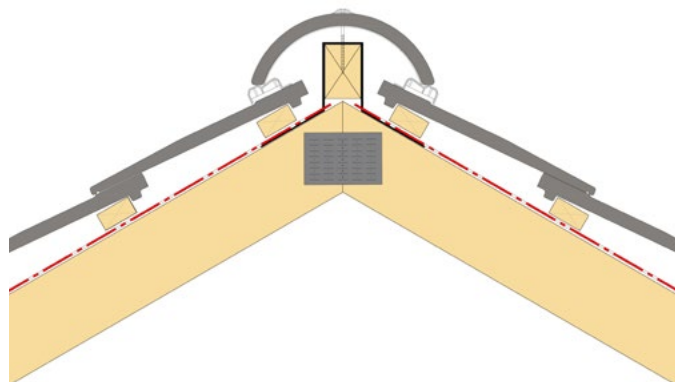

The Profile Mono Ridge system incorporates ventilation strips to support the ridges and provide high level roof space ventilation.

Product Technical Information Sheet

General Information

Size of Pack	1040mm (L) x 230mm (W) x 170mm (H)
Component quantities	To suit 6 metres of ridge
Profile Dry Ridge Ventilation Strip material	PP
Joint material	PP
Hip Strap material	Iron Galvanised
Screw material	Stainless Steel + rubber washer

Tile Compatibility (Flat Tiles)

20/20	Dual Calderdale Edge	TLE
Actua	Dual TLE	Vauban
Calderdale Edge	Plain Tiles (All)	
Cassius	Rivius	

Tile Compatibility (Profiled Tiles)

Double Pantile	Neo Plus	Shire Pantile
Double Roman	New County	Standard Pattern
Lindum	Olympus	

Ridge Compatibility

Clay Half Round Mono Ridge	305 mm
Concrete Half Round Mono Ridge	457 mm
Concrete Multi Angle Mono Ridge	457 mm
Duracoat Half Round Mono Ridge	457 mm
Duracoat Multi Angle Mono Ridge	457 mm

Guidance

Product specification is subject to change and will be updated accordingly.

Ridge joints provide an efficient seal between each ridge, giving the appearance of a 10mm mortar joint. To complete the system, and to enhance aesthetics, profile fillers are available for profiled tile types. The fillers easily click into the ventilation strips and both are marked to ensure correct orientation.

The mono ridges are secured to the wall or fascia using the screws and sealing washers supplied.

Product Image



Technical Drawing

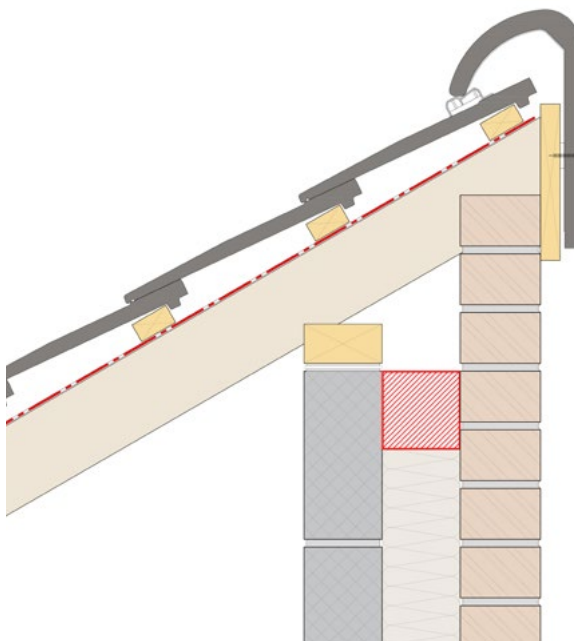

IN-LINE TILE VENTILATORS



In-Line ventilators are designed to maximise the aesthetic features of the roof by being virtually unseen once installed and can be used for both low-level and high-level ventilation, as well as for connection to soil or mechanical extraction pipes.

Product Technical Information Sheet

General Information

Minimum roof pitch*	All tile vents can be laid at a minimum pitch of 22.5°, or the minimum roof pitch of the compatible tile should that exceed 22.5°
Free vent area	10,000mm ² **
Spacing at low level (10,000mm ² per m)	1.00m intervals
Spacing at high level (5,000mm ² per m)	2.00m intervals
Material	Mix of ABS and PP

Tile Compatibility	Number of Tiles Replaced	Pipe Adaptor included with vent	Cut Batten Required for Installation*
20/20	2	Yes	Yes
Actua	1	Yes	Yes
Arcadia	2	No	Yes
Calderdale Edge	1	No	No
Cassius	1	No	No
Double Pantile	1	No	No
Double Roman	1	No	No
Dual Calderdale Edge	1	No	No
Dual TLE	1	No	No
Lindum	1	No	No
Modula	1	No	No
Neo Plus	1	No	Yes
New County	2	No	Yes
Old English	2	No	Yes
Olympus	1	No	No
Rivius	1	No	No
Shire Pantile	2	No	No (38mm) Yes (50mm)
TLE	1	No	No
Vauban	2	Yes	Yes

Guidance

Product specification is subject to change and will be updated accordingly.

Product Image



Image shown: 20/20 In-Line Tile Ventilator - Natural Red

Technical Drawing

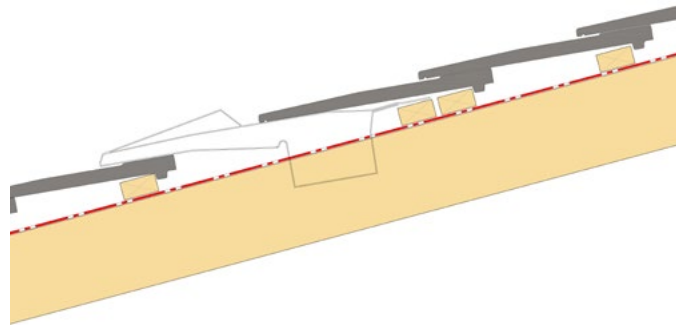

* A low pitch in-line ventilator is available for the 20/20 tile which can be laid down to 15°.

** Free vent area is 7,500mm² on the low pitch 20/20 in-line vent.

Cowl Ventilators provide a practical solution for high level roof space ventilation and for connection to soil or mechanical extraction pipes.

Product Technical Information Sheet

General Information

Minimum roof pitch	22.5**
Free vent area	3,000mm ²
Spacing at high level (5,000mm ² per m)	0.56 m intervals
Material	Product matches the associated tile material (Clay or Concrete)
Compatible accessories	In-Line/InvisiVent Pipe Adapter Flexi Pipe

Tile Compatibility¹

Arcadia	Dual TLE	Rivius
Calderdale Edge	Lindum	Shire Pantile
Cassius	Neo Plus	Tempest 44
Double Pantile	Old English Pantile	TLE
Double Roman	Old Hollow 451	
Dual Calderdale Edge	Olympus	

Guidance

Product specification is subject to change and will be updated accordingly.

For airflow resistance advice please contact Technical Services on 0330 383 0379.

Product Image

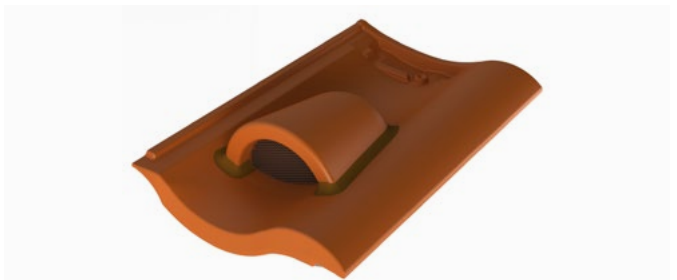
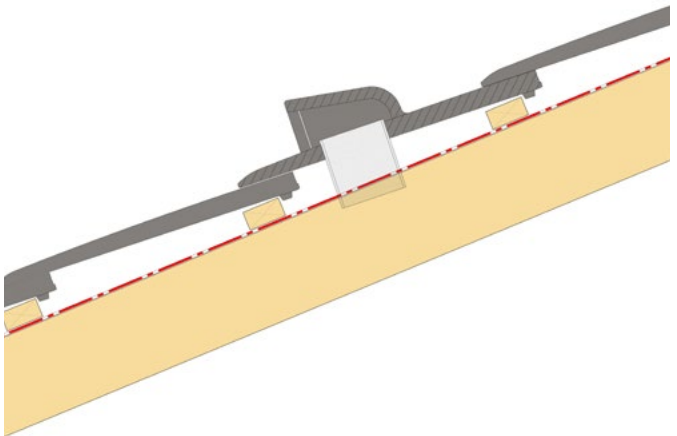

Image shown: Neo Plus Cowl Ventilator - Natural Red

Technical Drawing



¹ Not available in colours with a sanded finish.

* Where the minimum roof pitch recommended for a particular tile is greater than the ventilator minimum pitch then this minimum pitch also applies to the ventilator.

PLAIN TILE INVISIVENT®



The InvisiVent® is designed to be virtually unseen once installed and can be used for both low and high level ventilation, and for connection to soil or mechanical extraction pipes.

Product Technical Information Sheet

General Information

Minimum roof pitch	35° (40° Handmade)
Free vent area	7,500mm ²
Spacing at low level (10,000mm ² per m)	0.75 m intervals
Spacing at high level (5,000mm ² per m)	1.50 m intervals
Material	Product matches the associated tile material (Clay or Concrete)
Compatible accessories	In-Line/InvisiVent Pipe Adapter Flexi Pipe

Tile Compatibility¹

301 Plain Tile	Concrete Plain Tile	Peg Tile
303 Plain Tile	Goxhill Plain Tile	Shire Plain Tile
Alban Plain Tile	Humber Plain Tile	Traditional Plain Tile
Barrow Plain Tile	Humber sandfaced Plain Tile	Village Plain Tile

Guidance

Product specification is subject to change and will be updated accordingly.

For airflow resistance advice please contact Technical Services on 0330 383 0379.

Product Image

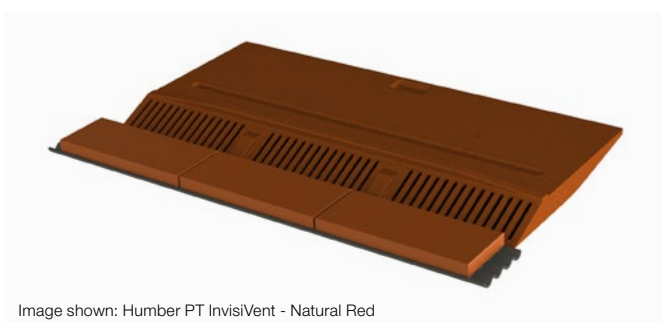
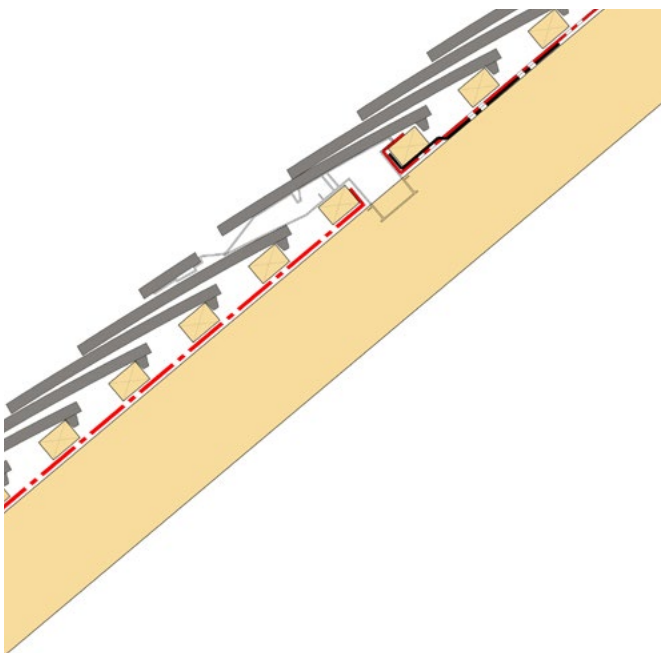

Image shown: Humber PT InvisiVent - Natural Red

Technical Drawing



¹ Not available in colours with a sanded finish.

Designed as a complete and comprehensive solution, Sandtoft over fascia ventilation provides continuous free vent areas of 10,000mm² and 25,000mm² and insulation retention irrespective of rafter centres and soffit width.

Product Technical Information Sheet

General Information

Free vent area (10mm Over Fascia Ventilator)	10,000mm ² per linear m
Free vent area (25mm Over Fascia Ventilator)	25,000mm ² per linear m
Component quantities	To suit 6 metres of eave
Underlay Support Tray material	PVC
Over fascia Ventilator material	PP
Spacer tray material	Recycled PVC

Tile Compatibility

All Wienerberger Tiles

Additional Bird Comb Filler Required (Sold Separately)

Double Pantile	New County	Shire Pantile
Modula	Old Hollow 451	
Neo Plus	Olympus	

Guidance

Product specification is subject to change and will be updated accordingly.

The over fascia ventilation strip provides effective resistance to large insects and driving rain.

The spacer tray provides a clear air path over the insulation irrespective of soffit width and roof pitch.

The underlay support tray prevents sagging of the underlay behind the fascia and eliminates the problem of long-term deterioration of the underlay at the eaves.

Product Image



Technical Drawing

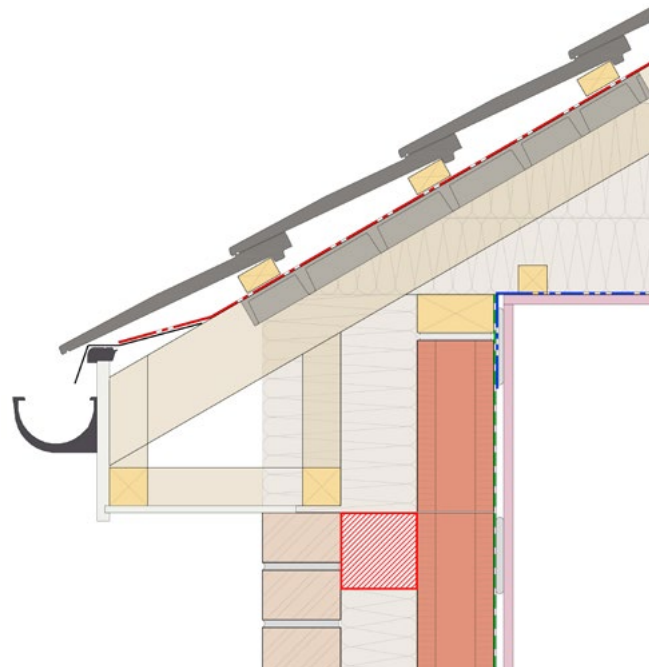

TOP ABUTMENT VENTILATOR

The Sandtoft top abutment ventilation system provides a neat and discreet way of ventilating the roof space at a top abutment.

Product Technical Information Sheet

General Information

Minimum roof pitch	Suits the minimum roof pitch of all compatible tiles
Compatible flashing	WBLR, Lead
Free Vent Area	5,000 mm ² /linear metre
Fixings	A minimum of 3 fixings per unit
Size of pack	1040 x 240 x 170 mm
Component quantities	To suit 6 metres of Top Abutment
Top Abutment Ventilator material	PS and Aluminium
Screw and washer material	Stainless Steel

Tile Compatibility (Flat Tiles)

301	Calderdale Edge	Humber Plain Tile
303	Cassius	Humber Sandfaced Plain Tile
20/20	Concrete Plain Tile	Rivius
Alban Plain Tile	Dual Calderdale Edge	TLE
Barrow Plain Tile	Dual TLE	Village Plain Tile

Tile Compatibility (Profiled Tiles)*

Double Pantile	Neo Plus	Shire Pantile
Double Roman	New County	Standard Pattern
Lindum	Olympus	

Guidance

Product specification is subject to change and will be updated accordingly.

The system comprises of 1 m vent units that click together, fillers can then be attached to the vent units for profiled tiles. Once the vent units are fixed in place a WBLR or lead flashing can be dressed into place, please refer to our installation guide for more information.

The Sandtoft top abutment ventilation system provides 5000mm²/linear metre free vent area.

Contact Sandtoft technical services for further information.

Product Image



Technical Drawing

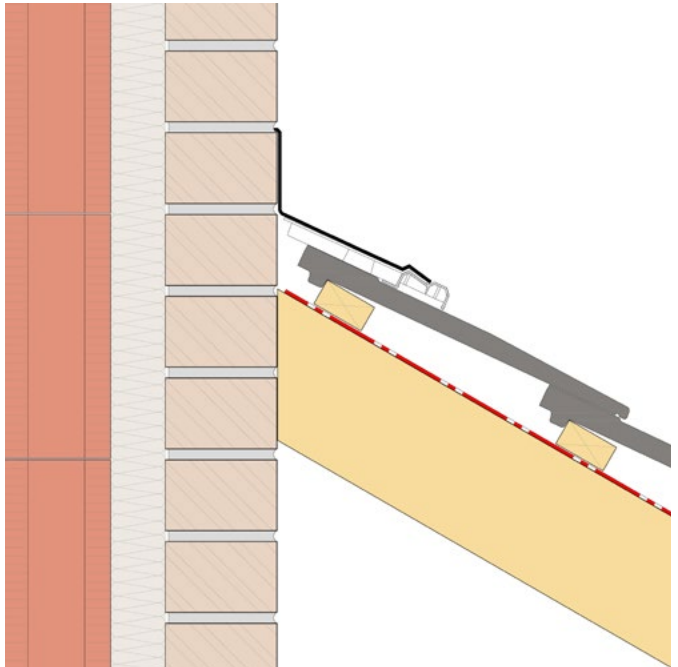

* Profile fillers are available separately.

Wienerberger Lead Replacement is an alternative to lead for weathering flashing material for buildings. It is aluminium based and available in two unique surface finishes (cross-corrugated and embossed) depending on the application.

Product Technical Information Sheet

General Information

Material	Aluminium and Butyl
Roll Length	5m
Roll Widths	300mm 450mm
Thickness	Corrugated - 4.1 mm Embossed - 0.65 mm
Installation temperature	Do not install if the outside temperature is 5°C or lower
Working temperature (when installed)	Minus 40°C - 90°C
Colours	Grey, Red*

Compatibility

Compatible with all roof coverings that do not contain a granular surface

Overlaps

Roof covering	150 mm minimum
Extended up abutments	75 mm minimum
Adjacent WBLR product	150 mm minimum

Surface Finishes

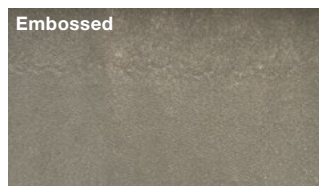
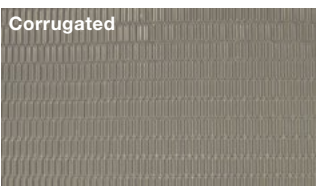

Guidance

Product specification is subject to change and will be updated accordingly.

Product Image



* Minimum quantity applies when ordering in red.

MORTARLESS BONDING GUTTER

An easy to install solution to weather the junction between roof coverings, such as in cases where an adjoining property is re-roofed in a different material.

Product Technical Information Sheet

General Information

Minimum roof pitch	17.5°
Size of pack	3 Metre Lengths
Fixings	Nail through the outer flanges and into the battens on both sides and at 500mm centres maximum
Material	GRP
Compatible accessories	Multiversal Top and Tail Clips

Tile Compatibility (75mm Upstand)*

301	Cassius	Rivius
303	Dual Calderdale	Standard Pattern
20/20	Dual TLE	TLE
Actua	Lindum	Vauban
Calderdale Edge	Plain Tiles (All)	

Tile Compatibility (100mm Upstand)*

Arcadia	Modula	Old Hollow 451
Bridgwater	Neo Plus	Olympus
Double Pantile	New County Pantile	Shire Pantile
Double Roman	Old English	Tempest 44

Guidance

Product specification is subject to change and will be updated accordingly.

The bonding gutter is available in two upstand heights to suit most flat and profile tiles and slates.

Roof tiles or slates are installed close to the bonding gutter upstand. Where the installation of small cut tiles is unavoidable Sandtoft provides a range of top and tail clips (available separately).

Product Image

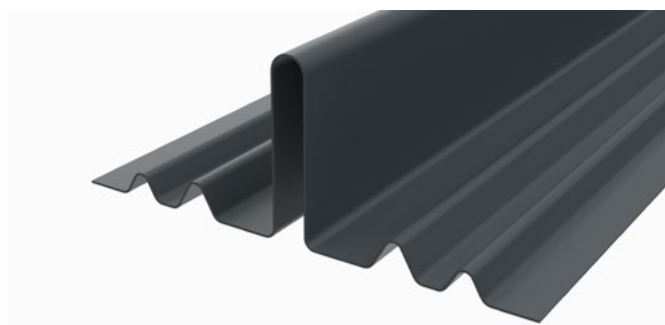

Technical Drawing

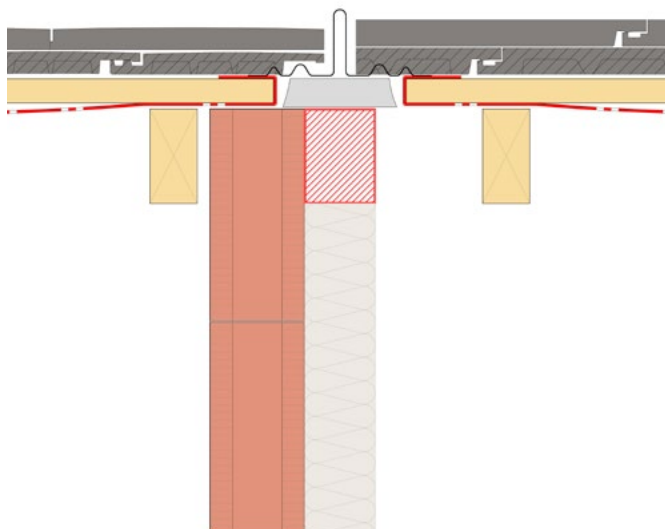

Sandtoft Universal Dry Valley trough is an easy to install solution that eliminates the problems associated with mortar-bedded valleys.

Product Technical Information Sheet

General Information	
Minimum roof pitch	17.5°
Maximum Roof Pitch	60°
Size of pack	3 Metre Lengths
Fixings	Nail through the outer flange into the supporting timbers at 500mm centres maximum
Material	GRP
Compatible accessories	Mortarless Hip/Valley Tile Top Clip Mortarless Hip/Valley Tile Tail Clip
Fire rating	Fire resistant. Designated AB fire rating
Tile Compatibility	All Tiles
Rafter Pitch	
	Min. Lap Length
17.5° to 19.5°	300mm
20° to 40°	220mm
Over 40°	1500mm

Guidance

Product specification is subject to change and will be updated accordingly.

Roof tiles or slates are installed close to the valley trough upstand. Where the installation of small cut tiles is unavoidable Sandtoft provides a range of top and tail clips (available separately).

Product Image



Technical Drawing

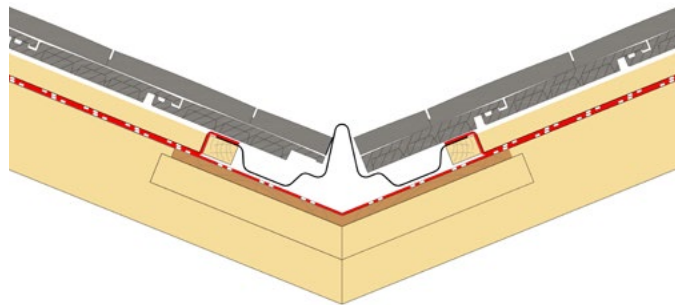

ACCESSORIES

Contents

Ridge Ventilation	120-121
Vapour Permeable Underlay	122
Ventilation	122
Dry Verge Systems	122
Flashing Systems	123
Valley	123
Bonding Gutter	123
VPM	123

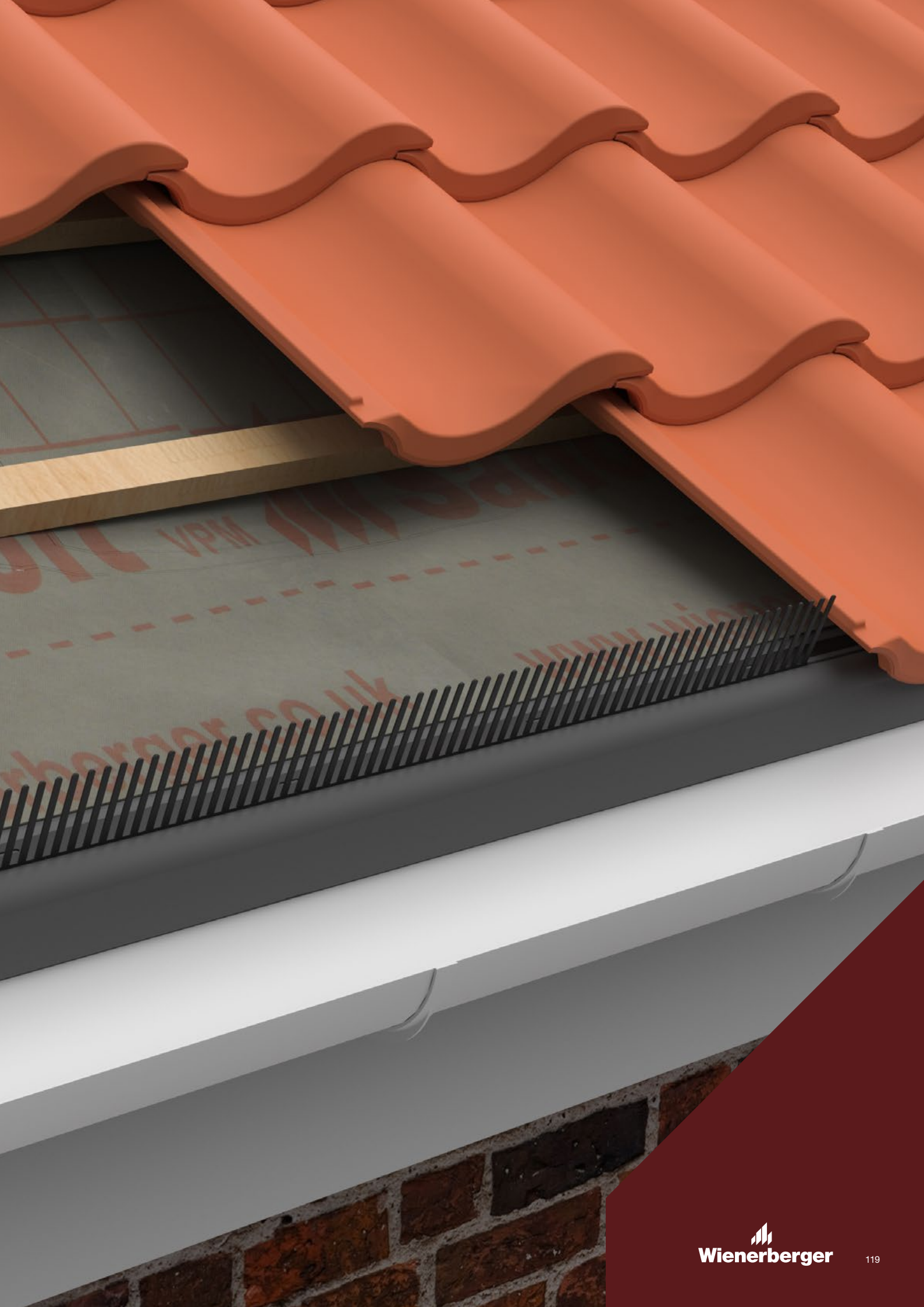



Ridge Ventilation

Half Round Roll Ridge Kit CON

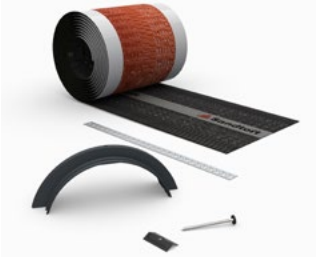

Half Round Roll Ridge Kit CLY

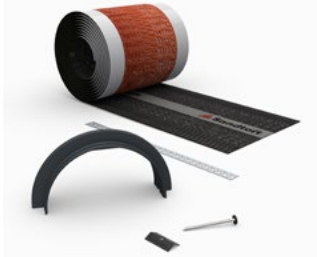

Multi Angle Roll Ridge & Hip Kit



Multiversal Roll Ridge & Hip Kit



Segmental Roll Hip Kit CON

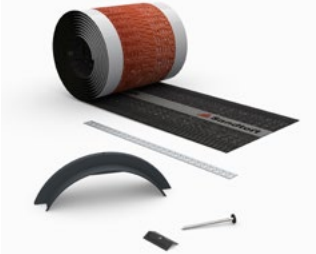

Third Round Roll Hip Kit CLY

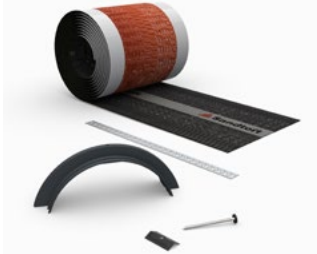

HR Profile Ridge Kit CON



HR Profile Ridge Kit CLY



MA Profile Ridge Kit



HR Profile Mono Ridge Kit CON



HR Profile Mono Ridge Kit CLY



MA Profile Mono Ridge Kit



Koramic 325 Profile Ridge Kit



Mortarless Hip/Valley Tile Top Clip



Mortarless Hip/Valley Tail Clip STD



Mortarless Hip/Valley Tail Clip TLE



Hip Tray



Mortar Bedded Ridge Fixing Kit



Multi Tape - 60mm x 25m



Nail Tape - Butyl



Ridge Ventilation (all items below are sold within packs)

HR Ridge Joint CON



HR Ridge Joint CLY



Multi Angle Ridge Joint



Multiversal Ridge Joint



Segmental Ridge Joint



HR Mono Ridge Joint CON



HR Mono Ridge Joint CLY



Multi Angle Mono Ridge Joint



Profile Dry Ridge Ventilation Strip



Ridge Fixing Pack CON



Ridge Fixing Pack CLY

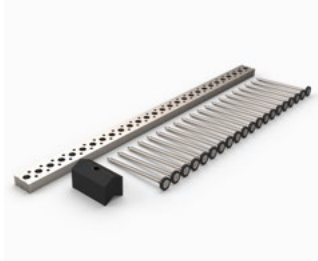

Mono Ridge Fixing Pack



Double Pantile PDR Filler



Double Roman PDR Filler



Lindum PDR Filler



Neo Plus PDR Filler



New County PDR Filler



Olympus PDR Filler



Shire Pantile PDR Filler



Standard Pattern PDR Filler



ACCESSORIES



Ventilation

InvisiVent



10mm Eaves Ventilation Pack



In-Line Vent



25mm Eaves Ventilation Pack



InvisiVent Pipe Adapter



Flexi Pipe (110mm diameter)



Bird Comb Filler



For use with profiled tiles.

Dry Verge System

Multiverge Standard Unit



Left and Right hand versions available (LH shown).

Multiverge Eaves Unit



Left and Right hand versions available (LH shown).

TLE/MF Standard Unit

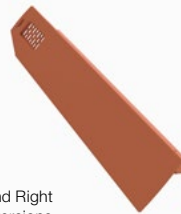

Left and Right hand versions available (LH shown).

TLE/MF Eaves Unit



Left and Right hand versions available (LH shown).

Ridge Closure Comb



For use with Block End Ridges.

Continuous Dry Verge D-Type



R-Type profile also available.

Continuous Dry Verge Connector



Continuous DV Eaves Stop End



Dry Verge System Colours

	Dark Grey / Antique Slate	Red Multi	Tuscan	Natural Red	Brown	Red	Black
Ridge							
Multiverge	✓	✓		✓	✓		
TLE/MF	✓	✓	✓	✓	✓		
Continuous Dry Verge						✓	✓
Half Round Ridge End Cap	✓	✓	✓	✓	✓		
Multi Angle Ridge End Cap	✓	✓		✓	✓		

Half Round Ridge End Cap



Multi Angle Ridge End Cap



Flashing System

Abutment Soaker - Large



Left and Right hand versions available (LH shown).

Abutment Soaker - Medium



Left and Right hand versions available (LH shown).

Abutment Soaker - TLE



Left and Right hand versions available (LH shown).

Continuous Side Abutment Secret Gutter 3m

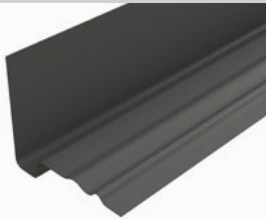

Top Abutment Ventilator Kit



Valley

Universal Dry Valley



Bonding Gutter

Mortarless Bonding Gutter 70mm Upstand

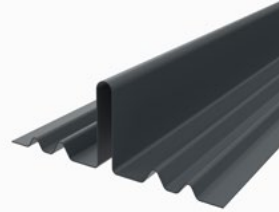

Mortarless Bonding Gutter 100mm Upstand

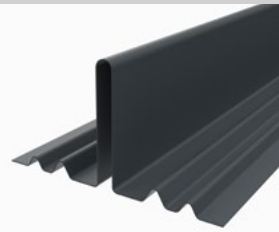

VPM

Sandtoft Super VPM



Sandtoft Classic VPM



Sandtoft Classic Taped VPM



Underlay Support Tray

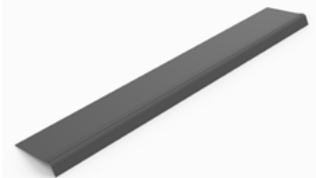

The logo for 'in-roofsolar' features the text 'in-roofsolar' in a lowercase, sans-serif font. A green chevron symbol is positioned to the right of the text. The background of the entire page is a photograph of a residential roof with grey tiles and several solar panels. A white semi-transparent box is overlaid on the left side of the page, containing the logo and a table of contents. A green geometric shape is visible in the bottom-left corner of the page.

in-roofsolar

Contents

A complete solar system for tomorrow's homes today	126
The in-roof solar solution	127
Which system size is right for my roof?	128
Unlock the full potential of your solar system	129





EVERYTHING YOU NEED FOR A SOLAR ROOF

What is in-roof solar?

In-roof solar is more than just a solar panel, it is a solar roof. No trays or complicated and unsightly mounting systems, in-roof solar is a seamless integrated roof panel that is easy to install and applied directly to the

roof battens. In-roof solar sets a new standard for the modern roof that embraces the traditional aesthetic of an overlapping tile, whilst providing a seamlessly integrated sustainable energy source.



MCS certified minimum roof pitch of 15 degrees.

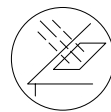

Independently wind-driven-rain tested at the BRE.



15-year product warranty* and 25-year performance guarantee.



Seamlessly smart integrated solar panels with no mess.

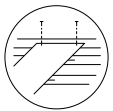

Mounts directly on battens; no trays needed.

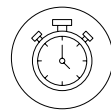

Fast, easy install with one-minute panel-to-panel connection.



What is in an inverter?

An inverter is one of the most important pieces of equipment in a solar energy system. It converts Direct Current (DC) electricity, generated from the solar panel, to Alternating Current (AC) electricity, that can be used to power electrical appliances and feed into the electrical grid.

*Sandtoft 15 year Roofspec offering incorporates both tiles and in-roof solar installation as a complete roof structure.

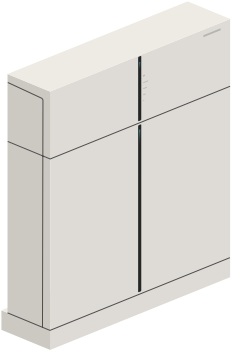

What is a battery?

A battery can store the excess electricity generated from solar panels or it can store electricity it's able to take directly from the grid. This stored energy can be used to power the property at times when solar panels don't generate enough electricity, including nights, cloudy days, or during power outages, or even when the energy demand is high by taking advantage of cheaper rates provided by the property's electricity provider.

The system options available

Grid-tied System

(No battery storage)

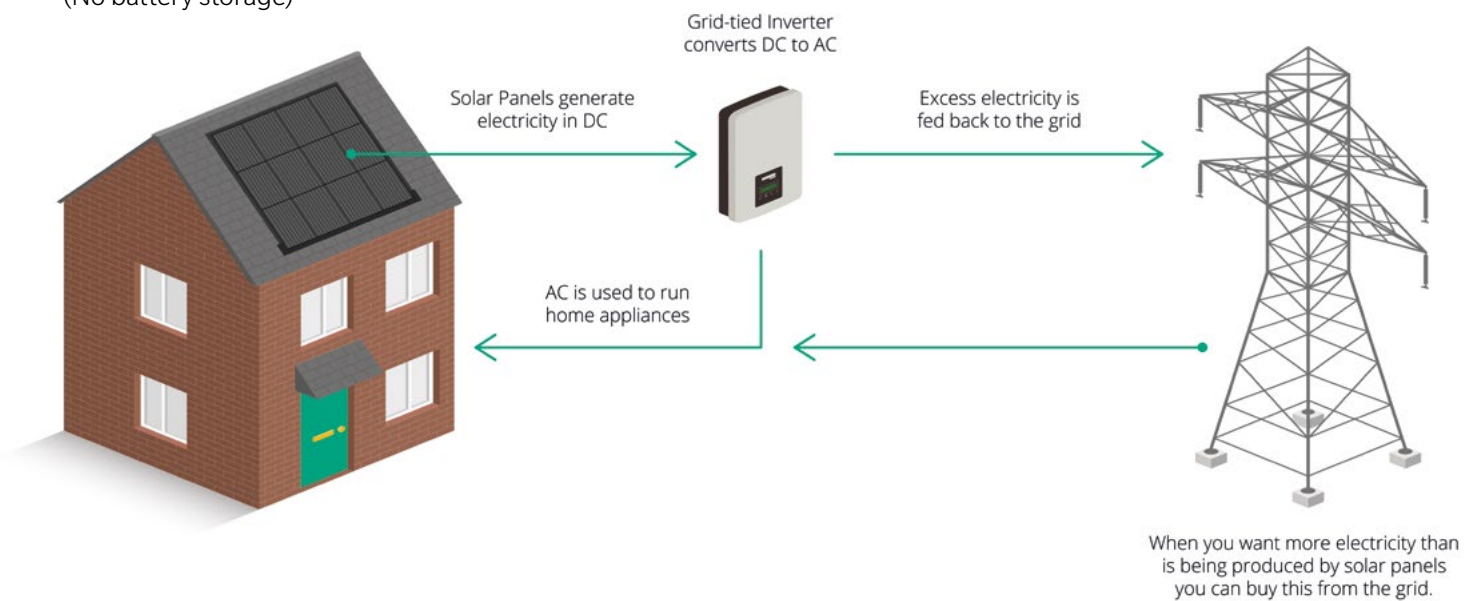

Hybrid System

(Battery storage)

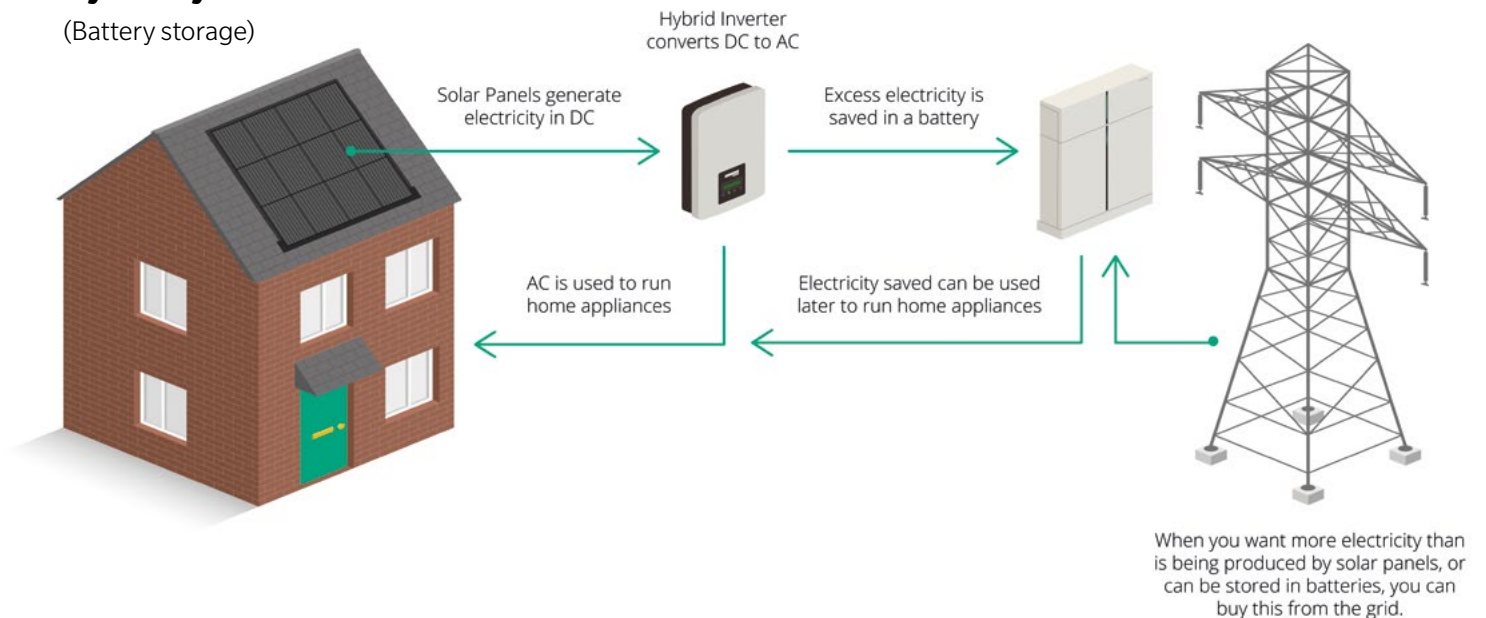

THE IN-ROOF SOLAR SOLUTION

Front and side profile

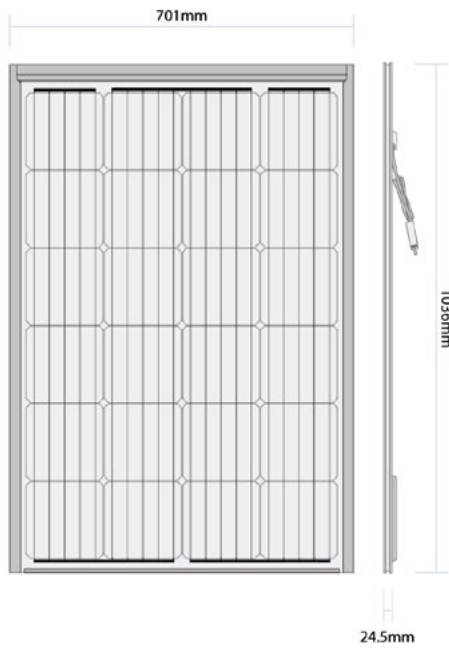

Cell Temperature I-V Curve

Showing how the voltage is affected by cell temperature.

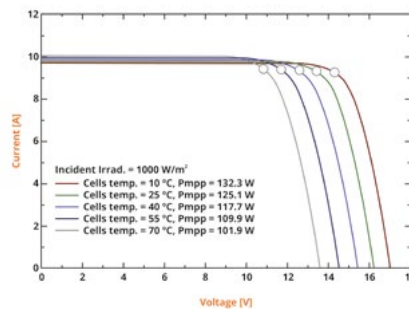

Irradiance I-V Curve

Showing how the current, power and voltage is affected by different light.

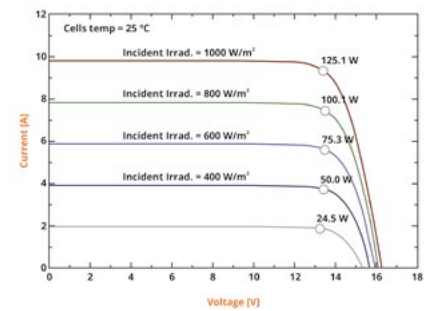

System components

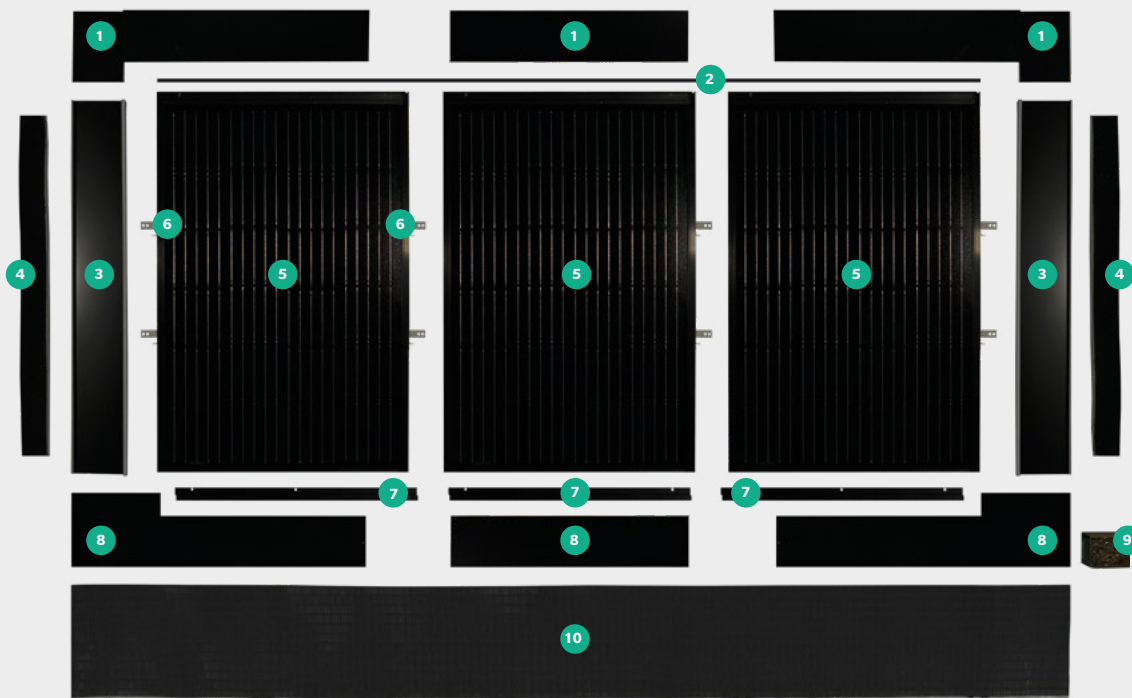

1. Aluminium flashing top (left, middle, right)
2. Seal strip 01
3. Aluminium flashing side (left & right)
4. Seal strip 02
5. IRT Panels (left, middle, right)
6. Mid-clamp (right & left)
7. Bottom edge
8. Aluminium flashing bottom (left, middle, right)
9. Self tapping screws
10. Lead replacement

TECHNICAL DETAILS

Electrical Performance

Module type	PLM-125MB-24 SERIES		
Power output	P _{max}	Wp	125
Voltage at P _{max}	V _{mp}	V	13.33
Current at P _{max}	I _{mp}	A	9.38
Open circuit voltage	V _{oc}	V	16.22
Short-circuit current	I _{sc}	A	9.79
Module efficiency	Eff	%	18.2

STC: 1000W/m² irradiance, 25°C cell temperature, AM 1.5g spectrum according to EN 60904-3 Power measurement uncertainty is within +/- 3%

Thermal Characteristics

Nominal operating cell temperature	NOCT	°C	45±2
Temperature coefficient of P _{max}	γ	%/ °C	-0.40
Temperature coefficient of V _{oc}	β _{Voc}	%/ °C	-0.30
Temperature coefficient of I _{sc}	α _{Isc}	%/ °C	0.06

Operating Conditions

Max. system voltage	1000VDC
Limiting reverse current	15A
Operating temperature range	-40°C to 85°C
Max. static load front (e.g., snow)	5400Pa
Max. static load back (e.g. wind)	3420Pa

Mechanical Characteristics

Front cover (material / thickness)	low-iron tempered glass/3.2mm
Backsheet (colour)	black
Cell (quantity/material/dimensions)	monocrystalline silicon/156.75x156.75mm
Frame (material/colour)	anodized aluminium alloy/black
Junction box (protection degree)	≥IP67
Cables & Plug connectors	900mm/4mm ² & MC4 compatible/IP67
Module Dimensions (L/W/H)	1036mmx701mmx24.5mm
Module Weight	8.95kg

INVERTERS AND BATTERIES FOR YOUR SOLAR SYSTEM

When it comes to harnessing the power of solar energy, it takes more than just high-quality panels to create a truly efficient and reliable system. That’s why we are proud to offer inverters and batteries, in partnership with our chosen supplier Solax. All our inverters and batteries come with a 5 year product guarantee to provide you with a complete integrated solution.

Inverters

We offer a range of both grid-tied and hybrid inverters (see page 5) to cater to a wide range of project sizes and requirements. Whether you need a grid-tied or hybrid solution, we have the perfect inverter for you. From small

residential installations to medium-sized commercial projects, all the way up to large-scale applications, our inverter options ensure optimum performance and seamless integration with your solar system.

Solax Grid-tied Inverters



Small systems

Available in:

1.1kW, 1.5kW, 2.0kW, 2.5kW

Medium systems

Available in:





3.0kW, 3.6kW, 4.2kW, 5.0kW, 6.0kW

Large systems

Available in:

8.0kW

Features:

-  Remote Upgrade and Control
-  Waterproof
-  LCD Touch Display
-  Online Monitoring

Applicable only to large systems:

-  Support EV Charger (Fast Charging Mode)

Solax Hybrid Inverters (Compatible with batteries)



Small systems

Available in:

3.0kW & 3.7kW

Medium systems

Available in:





5.0kW & 6.0kW

Large systems

Available in:

7.5kW

Features:

-  Remote Upgrade and Control
-  Waterproof
-  LCD Touch Display
-  Online Monitoring

Applicable only to large systems:

-  Support EV Charger (Fast Charging Mode)

Empower Your System with Batteries

If you're looking to take your solar system to the next level, our selection of batteries are here to provide you with enhanced energy management capabilities. By incorporating batteries into your setup (available in 3,6,9 and 12kW) you can store excess energy generated during the day and use it during peak demand or when the sun isn't shining. With our range of batteries, you have the flexibility to choose the solution that aligns perfectly with your energy needs.

Why choose a battery?

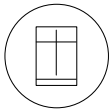

Store both electricity generated from your solar system and supplied directly from the grid.



Take advantage of cheaper rates with a battery system. It is cheaper to use stored energy than exporting it to the grid and buying it back at higher prices.



You can purchase and store energy from the grid at a cheaper price (usually at night) and use it for the rest of the day or whenever suits your lifestyle.



Help to meet Part L legislation and envisaged Future Homes Standards 2025 by reducing household carbon emissions.

Solax Triple Power 3.0 Battery



[Click here](#) for all technical information you may need

Maximise energy generation and reduce costs

We understand that navigating through the intricacies of inverters and batteries can be overwhelming. But fear not, our team of experts are here to guide you every step of the way. With their deep knowledge and experience, we'll work closely with you to understand your unique requirements and help select the most efficient and cost-effective solution for your project. Our experts are committed to ensuring that you have

a solar system that both maximise energy generation and reduces costs.

Take the next step towards a greener future today with a solar system that empowers you with clean, sustainable energy.

Get in touch: wbukmarketing@wienerberger.com

WHICH SYSTEM SIZE IS RIGHT FOR MY ROOF?

When applying in-roof solar it's useful to know what system is suitable for your roof type.

3 kW Peak System

This illustration shows a typical **3kW** system applied to an up-and-over roof style with 24 panels.

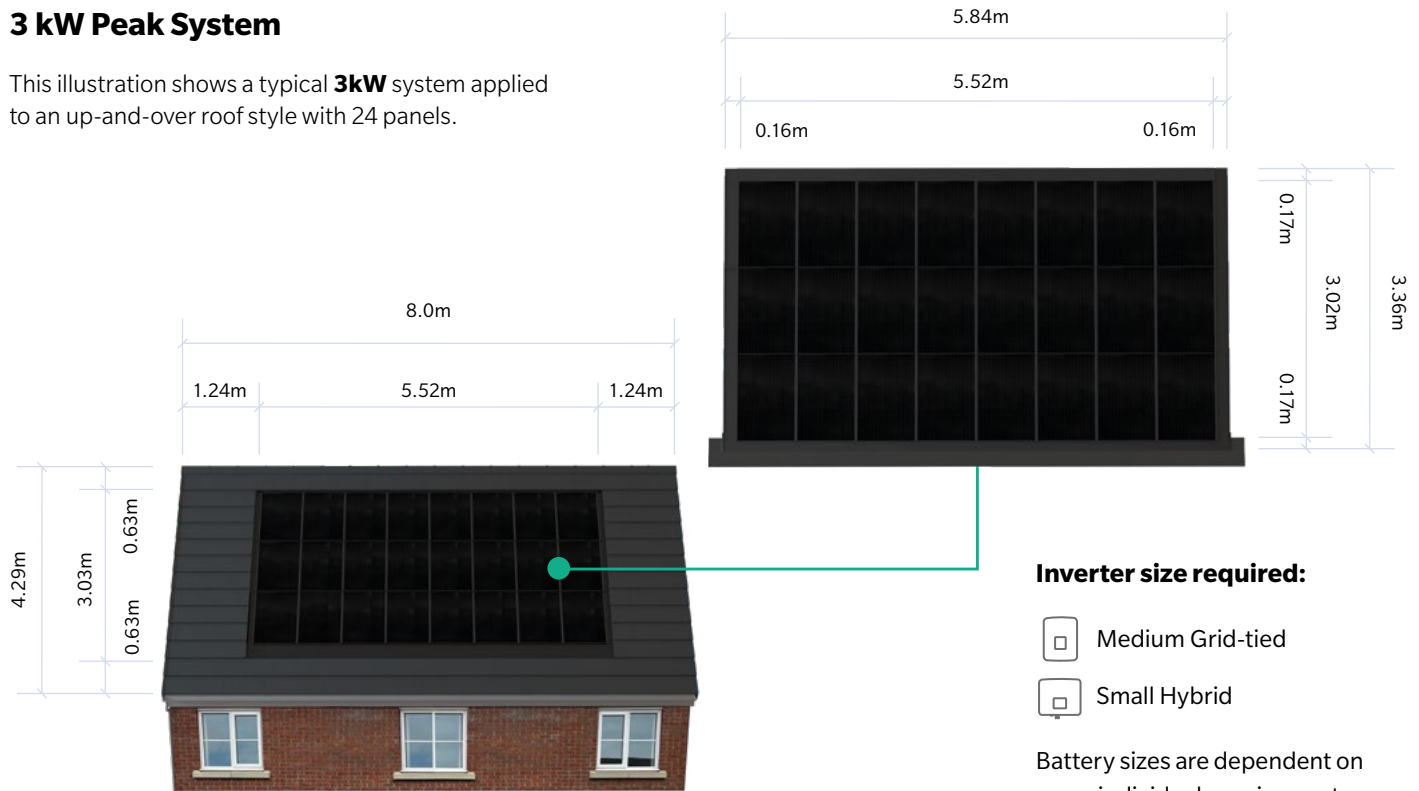

Inverter size required:

- Medium Grid-tied
- Small Hybrid

Battery sizes are dependent on users individual requirements.

1.5 kW Peak System

This illustration shows a typical **1.5kW** system on two semi-detached properties, applied to an up-and-over roof style with 12 panels on each house.

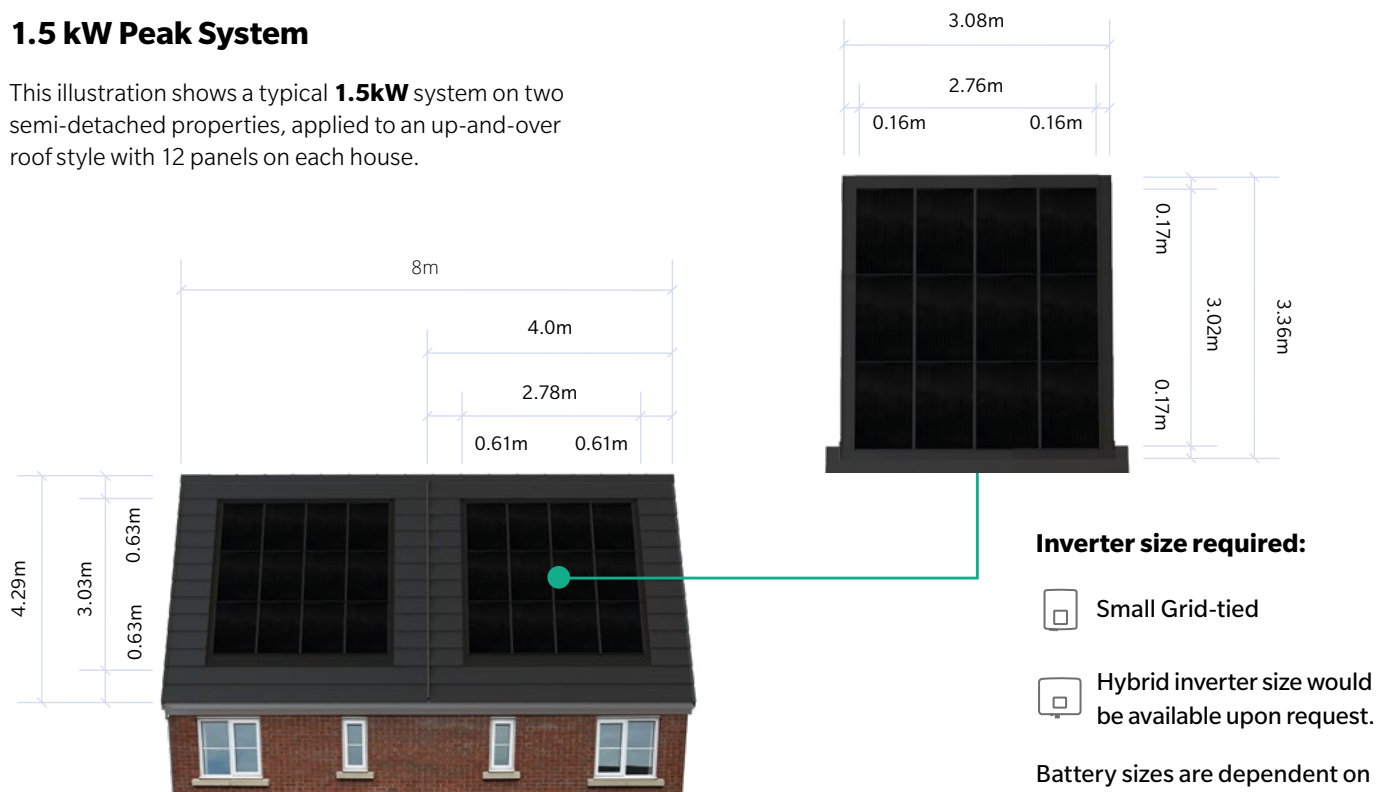

Inverter size required:

- Small Grid-tied
- Hybrid inverter size would be available upon request.

Battery sizes are dependent on users individual requirements.

UNLOCK THE FULL POTENTIAL OF YOUR SOLAR SYSTEM

Uncertain about the specific products that would best suit your solar system?

Our design team is here to alleviate the stress out of roof specification. We understand that selecting the right components can be overwhelming, which is why we are happy to collaborate with you to:

- Maximise the potential of your solar system by allowing us to select the right system for you.
- Enhance the efficiency of your solar system and minimise technical complications.
- Simplify the installation process by allowing our experts to specify the most compatible products for your solar system.



How our design team can help?



Tailored specification requirements for your specific projects needs.



Easy access to on-hand technical experts whenever you need us.



Complete roof design with all relevant details provided.



A four-day maximum turnaround to any query.

Find the perfect solution for your roof by filling out our convenient enquiry form using the QR code below. Alternatively, you can visit our website, and our dedicated team will promptly be in touch to assist you.

What do you get?

- Roof specification plans.
- Panel placement (arrangement, spacing, alignment).
- Positioning/layout recommendations.
- Electrical connection advice.
- Safety measures and compliance regulations (Considerations document).
- Recommendation on Inverter sizing.

Click here to get started

or visit: www.wienerberger.co.uk/solar

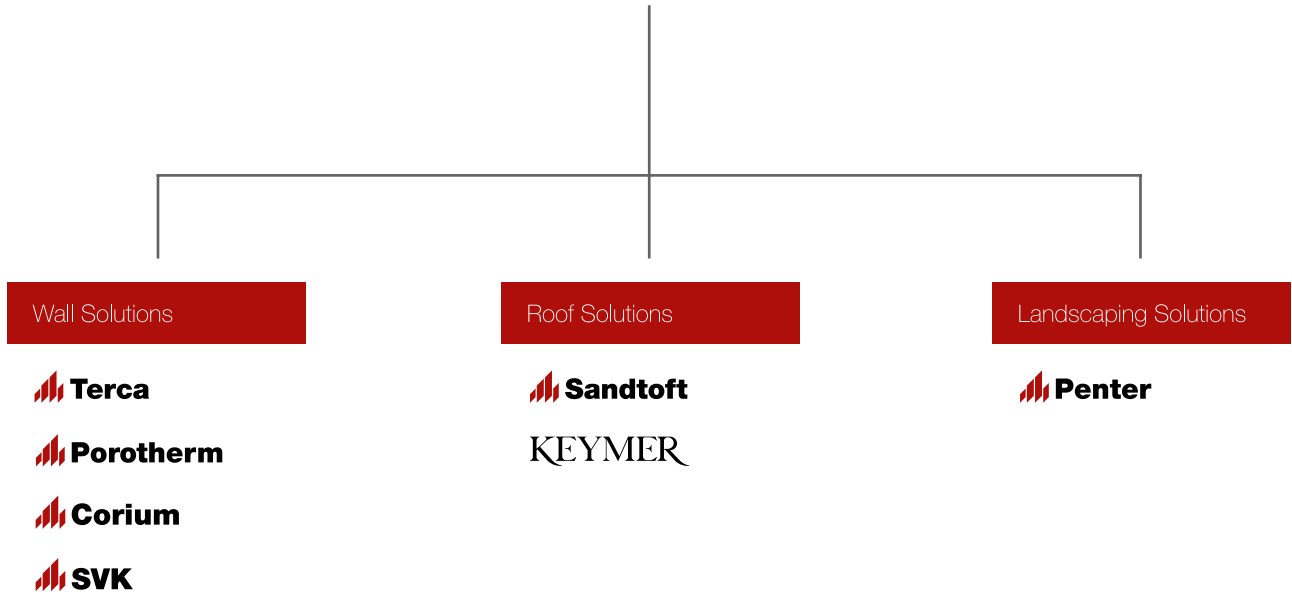

Wienerberger Ltd
Wienerberger House
Brooks Drive
Cheadle Royal Business Park
Cheadle, Cheshire
SK8 3SA

- T: 0333 3050 572
- wbukmarketing@wienerberger.com
- @wienerbergeruk
- www.wienerberger.co.uk



Have questions?

Want to know more, or are you looking for support with your next project? Visit our website to contact us. Our team of experts are ready to answer your questions.