

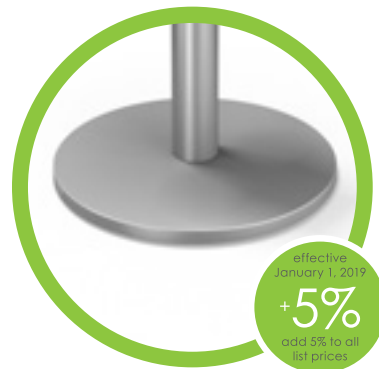

44 PRIMARY
price list
effective January 1, 2018





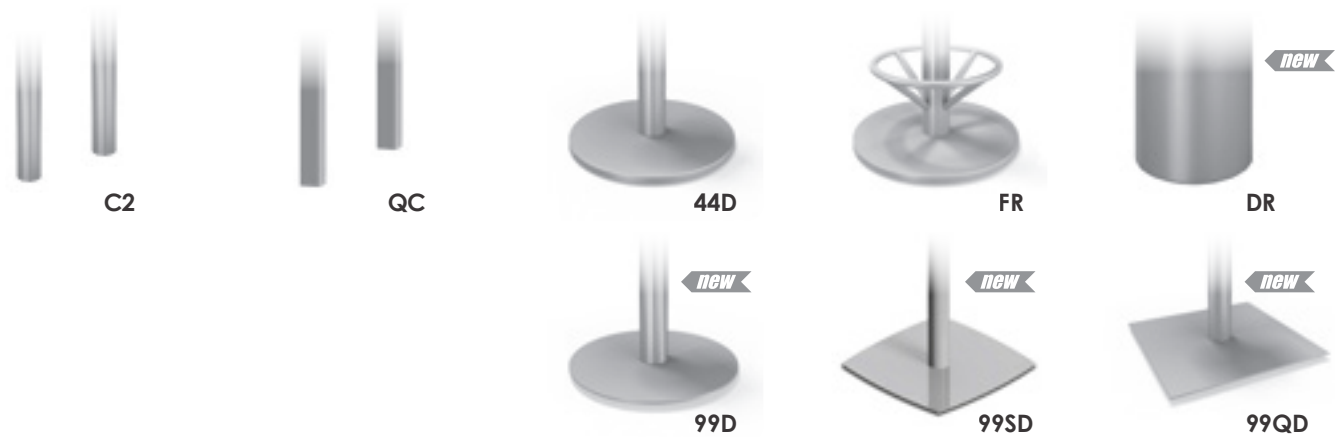

Maximize your foot space with durable traditional column bases. Primary's combination of columns, disc, and drum bases offer alternatives to meet a wide array of applications.

Primary Base Styles



Primary Base Options

 <p>standard glides</p>	<p>LC Locking Casters can be added to any table for \$90.</p>	<p>CH Chrome Finish available for \$25 per column. Upcharge for 44D disc bases is \$400.</p>	<p>SH Special Height of can be added to any table: + \$65 per column for heights > 29" + \$35 per column for heights < 29" Special height tables larger than 36x72" must be custom quoted.</p>
	<p>QC Square Columns are available for an upcharge of \$35 per column.</p>	<p>WM Wire Management Built in wire management is available on one column for \$125.</p>	<p>FR Footring available on standing height disc-bases for \$150 per base. Not available in chrome.</p>
 <p>locking casters</p>	<p>FD Folding Bases are not available on Primary tables.</p>	<p>WMLC Wire Management Leg Covers snap onto round columns and are \$45 each.</p>	<p>PB Power Box Mounting Plate is available on disc bases for \$90.</p>
	<p>NE Nesting Tables are not available on Primary tables.</p>	<p>MMLC Magnet Wire Management Leg Covers Magnetically snap onto any square leg and are \$55 each.</p>	
	<p>FT Flip Tops available some disc-based tables and are priced with standard glides.</p>		

Primary



Primary Height Adjustable Options

- NU Pneumatic** is available on disc bases for \$350 per table.
- AH Spring Clip** is available on X-bases for \$125 and on round column bases for \$500 per table. Not available in chrome.
- RA Ratchet** is not available on Primary tables.
- BL Counterbalanced and short balanced** are available on disc bases and are available in three finishes:
 - 02 Black
 - 30 Pearl
 - 37 Satin Silver

Primary Top Shapes

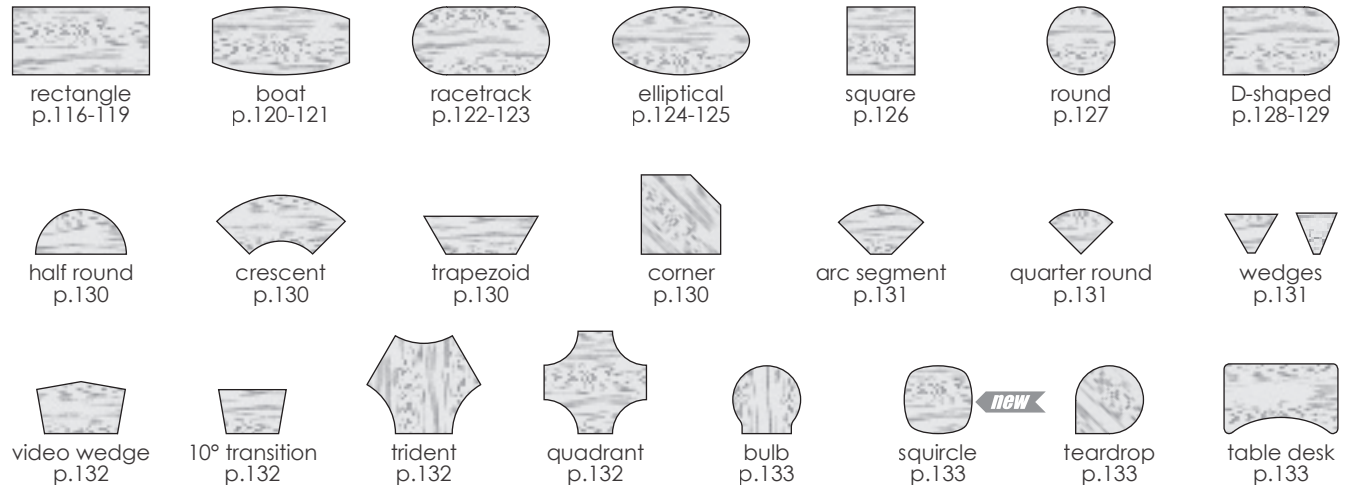

Primary Top Options

- RC 3" Radius Corners** can be added to any table for \$55.
- LT Lightweight Tops** can be added to any square or rectangular table for \$115.
- GR Grommets** can be added to any table for \$40 each. To see specific locations, see page 203.
- GN Ganging Brackets** can be added to most table shapes for \$40.
- CM Cable Manager** can be added to any table for \$50 each. To see specific locations, see page 203.

Primary Edge Options

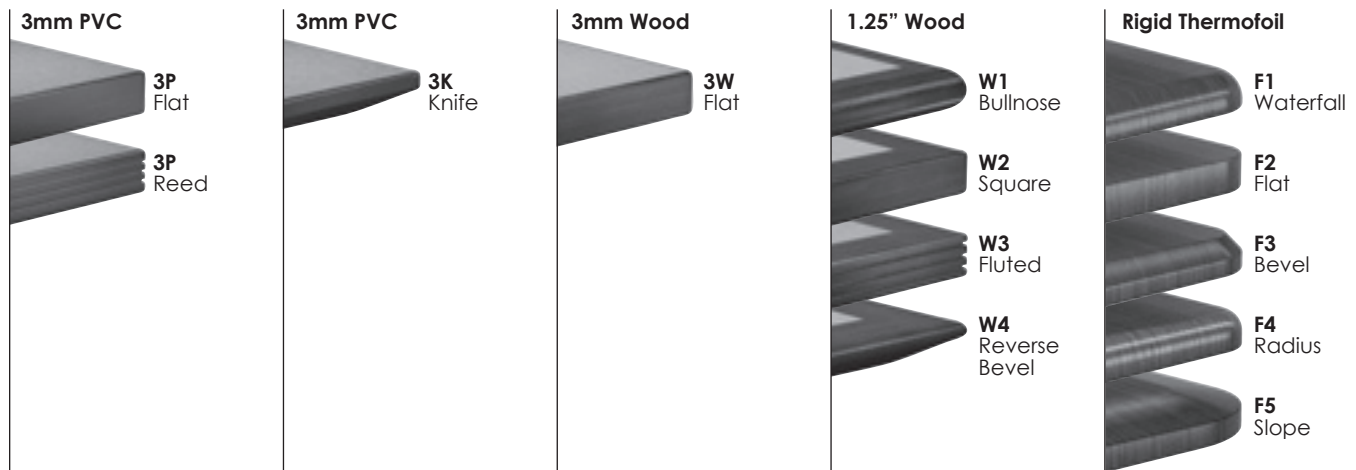

(correspond with 5 columns of pricing)





Primary

effective January 1, 2019
+5%
add 5% to all list prices

Rectangular with column bases	Top Size	Base	Model Number	3P	3K	3W	W1-W4	F1-F5
	18 x 36	Static	44TC1836C2	\$ 490	\$ 533	\$ 626	\$ 775	\$ 539
	18 x 48	Static	44TC1848C2	525	582	692	871	564
	18 x 60	Static	44TC1860C2	628	700	826	1,039	701
	18 x 72	Static	44TC1872C2	663	748	892	1,139	793
	18 x 84	Static	44TC1884C2	698	797	959	1,239	816
	18 x 90	Static	44TC1890C2	733	846	1,011	1,289	816
	18 x 96	Static	44TC1896C2	733	846	1,025	1,336	826
	20 x 36	Static	44TC2036C2	524	581	668	794	558
	20 x 48	Static	44TC2048C2	570	645	746	898	575
	20 x 60	Static	44TC2060C2	660	743	865	1,066	734
	20 x 72	Static	44TC2072C2	699	799	937	1,170	772
	20 x 84	Static	44TC2084C2	776	906	1,049	1,274	894
	20 x 90	Static	44TC2090C2	822	971	1,113	1,324	894
	20 x 96	Static	44TC2096C2	822	971	1,127	1,374	915
	24 x 36	Static	44TC2436C2	524	581	677	837	619
	24 x 48	Static	44TC2448C2	570	645	755	944	636
	24 x 60	Static	44TC2460C2	660	743	874	1,124	772
	24 x 72	Static	44TC2472C2	699	799	946	1,232	805
	24 x 84	Static	44TC2484C2	776	906	1,058	1,343	969
	24 x 90	Static	44TC2490C2	822	971	1,122	1,397	980
	24 x 96	Static	44TC2496C2	822	971	1,136	1,451	991
	30 x 36	Static	44TC3036C2	558	629	728	898	662
	30 x 48	Static	44TC3048C2	615	708	818	1,021	673
	30 x 60	Static	44TC3060C2	701	801	934	1,209	904
	30 x 72	Static	44TC3072C2	745	863	1,010	1,328	980
	30 x 84	Static	44TC3084C2	854	1,015	1,157	1,447	991
	30 x 90	Static	44TC3090C2	911	1,095	1,234	1,509	1,012
	30 x 96	Static	44TC3096C2	911	1,095	1,248	1,567	1,022
	36 x 48	Static	44TC3648C2	660	771	882	1,094	723
	36 x 60	Static	44TC3660C2	796	934	1,052	1,293	1,001
	36 x 72	Static	44TC3672C2	839	994	1,127	1,424	1,122
	36 x 84	Static	44TC3684C2	932	1,124	1,257	1,555	1,143
	36 x 90	Static	44TC3690C2	999	1,218	1,344	1,620	1,154
	36 x 96	Static	44TC3696C2	999	1,218	1,358	1,686	1,159

Top Size	Base	Model Number	3P	3K	3W	W1-W4	F1-F5	Rectangular with 2 thin disc bases
24 x 60	Static	99TC2460D20	\$ 1,103	\$ 1,186	\$ 1,317	\$ 1,567	\$ 1,237	 
24 x 72	Static	99TC2472D20	1,142	1,242	1,389	1,675	1,270	
24 x 84	Static	99TC2484D20	1,219	1,349	1,501	1,786	1,434	
24 x 90	Static	99TC2490D20	1,333	1,482	1,633	1,908	1,517	
24 x 96	Static	99TC2496D20	1,333	1,482	1,647	1,962	1,527	
30 x 60	Static	99TC3060D20	1,144	1,244	1,377	1,652	1,370	
30 x 72	Static	99TC3072D20	1,188	1,306	1,453	1,771	1,445	
30 x 84	Static	99TC3084D20	1,297	1,458	1,600	1,890	1,456	
30 x 90	Static	99TC3090D20	1,422	1,606	1,745	2,020	1,548	
30 x 96	Static	99TC3096D20	1,422	1,606	1,759	2,078	1,559	
36 x 72	Static	99TC3672D24	1,341	1,496	1,629	1,926	1,649	
36 x 84	Static	99TC3684D24	1,434	1,626	1,759	2,057	1,670	
36 x 90	Static	99TC3690D24	1,569	1,788	1,915	2,191	1,752	
36 x 96	Static	99TC3696D24	1,569	1,788	1,928	2,256	1,758	
42 x 72	Static	99TC4272D32	1,633	1,827	1,945	2,213	1,854	
42 x 84	Static	99TC4284D32	1,710	1,935	2,057	2,356	1,875	
42 x 90	Static	99TC4290D32	1,853	2,109	2,222	2,493	1,968	
42 x 96	Static	99TC4296D32	1,853	2,109	2,236	2,566	1,978	

2 thin disc bases: **CH** **SH**
NA +130



Top Size	Base	Model Number	3P	3K	3W	W1-W4	F1-F5	Rectangular with 2 disc bases
24 x 60	Static	44TC2460D20	\$ 1,336	\$ 1,419	\$ 1,551	\$ 1,800	\$ 1,482	 
24 x 72	Static	44TC2472D20	1,376	1,475	1,622	1,908	1,515	
24 x 84	Static	44TC2484D20	1,452	1,583	1,734	2,020	1,679	
24 x 90	Static	44TC2490D20	1,566	1,715	1,867	2,142	1,762	
24 x 96	Static	44TC2496D20	1,566	1,715	1,881	2,195	1,772	
30 x 60	Static	44TC3060D20	1,377	1,477	1,610	1,885	1,614	
30 x 72	Static	44TC3072D20	1,422	1,540	1,687	2,004	1,690	
30 x 84	Static	44TC3084D20	1,530	1,691	1,834	2,123	1,701	
30 x 90	Static	44TC3090D20	1,655	1,839	1,978	2,253	1,793	
30 x 96	Static	44TC3096D20	1,655	1,839	1,992	2,311	1,804	
36 x 72	Static	44TC3672D24	1,595	1,750	1,883	2,180	1,916	
36 x 84	Static	44TC3684D24	1,688	1,880	2,013	2,311	1,937	
36 x 90	Static	44TC3690D24	1,823	2,042	2,168	2,444	2,019	
36 x 96	Static	44TC3696D24	1,823	2,042	2,182	2,510	2,024	
42 x 72	Static	44TC4272D32	1,946	2,140	2,258	2,527	2,182	
42 x 84	Static	44TC4284D32	2,023	2,248	2,370	2,669	2,204	
42 x 90	Static	44TC4290D32	2,167	2,422	2,535	2,806	2,296	
42 x 96	Static	44TC4296D32	2,167	2,422	2,549	2,879	2,307	

2 disc base: **CH** **SH**
+800 +130

effective January 1, 2019
+5%
add 5% to all list prices

- LC**
NA
- QC**
NA
- CH**
NA
- WM**
+125
- WMLC**
+45
- WMLC**
NA
- SH**
+130
- FR**
+300
- PB**
NA
- GR**
+40
- CM**
+50
- RC**
+55
- GN**
+40
- LT**
+115
- AH**
NA
- NU**
NA

NEW

Rectangular with drum bases	Top Size	Base	Model Number	3P	3K	3W	W1-W4	F1-F5
 	30 x 60	Drum	44TC3060DR18	\$3,519	\$3,619	\$3,751	\$4,026	\$3,863
	30 x 72	Drum	44TC3072DR18	3,563	3,681	3,828	4,146	3,938
	30 x 84	Drum	44TC3084DR18	3,671	3,833	3,975	4,265	3,949
	30 x 90	Drum	44TC3090DR18	3,797	3,981	4,120	4,394	4,042
	30 x 96	Drum	44TC3096DR18	3,797	3,981	4,133	4,452	4,052
	36 x 60	Drum	44TC3660DR18	3,614	3,752	3,870	4,111	3,960
	36 x 72	Drum	44TC3672DR18	3,656	3,812	3,945	4,242	4,080
	36 x 84	Drum	44TC3684DR18	3,749	3,942	4,074	4,373	4,102
	36 x 90	Drum	44TC3690DR18	3,884	4,104	4,230	4,506	4,184
	36 x 96	Drum	44TC3696DR18	3,884	4,104	4,244	4,572	4,189
	42 x 72	Drum	44TC4272DR24	3,957	4,151	4,269	4,538	4,294
	42 x 84	Drum	44TC4284DR24	4,035	4,260	4,382	4,680	4,316
	42 x 90	Drum	44TC4290DR24	4,178	4,433	4,546	4,818	4,408
	42 x 96	Drum	44TC4296DR24	4,178	4,433	4,560	4,891	4,419
	48 x 72	Drum	44TC4872DR24	4,027	4,248	4,359	4,634	4,406
	48 x 84	Drum	44TC4884DR24	4,035	4,260	4,396	4,784	4,427
	48 x 90	Drum	44TC4890DR24	4,179	4,434	4,561	4,929	4,541
	48 x 96	Drum	44TC4896DR24	4,179	4,434	4,575	5,006	4,551

drum bases: **CH** **SH**
NA NA

Primary

- LC**
NA
- QC**
NA
- CH**
NA
- WM**
NA
- WMLC**
NA
- WMLC**
NA
- SH**
NA
- FR**
NA
- PB**
NA
- GR**
+40
- CM**
+50
- RC**
+55
- GN**
+40
- LT**
+115
- AH**
NA
- NU**
NA



Top Size	Base	Model Number	3P	3K	3W	W1-W4	F1-F5	Rectangular with 3 thin disc bases	NEW
42 x 120	Static	99TC42120D32(3)	\$2,708	\$3,087	\$3,177	\$3,392	\$3,215		
42 x 144	Static	99TC42144D32(3)	2,863	3,304	3,403	3,673	3,236		

3 thin disc bases: **CH** **SH**
NA +195



Top Size	Base	Model Number	3P	3K	3W	W1-W4	F1-F5	Rectangular with 3 disc bases	NEW
42 x 120	Static	44TC42120D32(3)	\$3,177	\$3,556	\$3,646	\$3,862	\$3,708		
42 x 144	Static	44TC42144D32(3)	3,333	3,774	3,872	4,143	3,729		

3 disc base: **CH** **SH**
+1200 +195



Top Size	Base	Model Number	3P	3K	3W	W1-W4	F1-F5	Rectangular with 3 drum bases	NEW
42 x 120	Drum	44TC42120DR24(3)	\$6,195	\$6,573	\$6,663	\$6,879	\$6,876		
42 x 144	Drum	44TC42144DR24(3)	6,350	6,791	6,889	7,160	6,897		
48 x 120	Drum	44TC48120DR24(3)	6,204	6,587	6,688	7,017	6,929		
48 x 144	Drum	44TC48144DR24(3)	6,361	6,806	6,916	7,317	6,982		



drum bases: **CH** **SH**
NA NA



- LC**
NA
- QC**
NA
- CH**
NA
- WM**
+125
- WMLC**
+45
- WMLC**
NA
- SH**
+195
- FR**
+450
- PB**
NA
- GR**
+40
- CM**
+50
- RC**
+55
- GN**
+40
- LT**
+115
- AH**
NA
- NU**
NA





NEW

Boat-Shaped with 2 thin disc bases	Top Size	Base	Model Number	3P	3K	3W	W1-W4	F1-F5
 	30 x 42 x 84	Static	99BT3084D24	\$ 1,716	\$2,022	\$2,042	\$ 2,761	\$ 1,582
	30 x 42 x 90	Static	99BT3090D24	1,893	2,242	2,243	2,929	1,902
	30 x 42 x 96	Static	99BT3096D24	1,893	2,242	2,257	3,026	1,914
	36 x 48 x 84	Static	99BT3684D32	2,019	2,367	2,363	3,098	2,022
	36 x 48 x 90	Static	99BT3690D32	2,210	2,608	2,580	3,270	2,146
	36 x 48 x 96	Static	99BT3696D32	2,210	2,608	2,594	3,371	2,158



2 thin disc bases: **CH** **SH**
NA +130

NEW

Boat-Shaped with 2 disc bases	Top Size	Base	Model Number	3P	3K	3W	W1-W4	F1-F5
 	30 x 42 x 84	Static	44BT3084D24	\$ 1,970	\$2,276	\$2,296	\$ 3,015	\$ 1,849
	30 x 42 x 90	Static	44BT3090D24	2,147	2,495	2,497	3,183	2,168
	30 x 42 x 96	Static	44BT3096D24	2,147	2,495	2,511	3,279	2,181
	36 x 48 x 84	Static	44BT3684D32	2,332	2,680	2,676	3,412	2,351
	36 x 48 x 90	Static	44BT3690D32	2,523	2,921	2,893	3,584	2,475
	36 x 48 x 96	Static	44BT3696D32	2,523	2,921	2,907	3,684	2,487

2 disc base: **CH** **SH**
+800 +130

NEW

Boat-Shaped with 2 drum bases	Top Size	Base	Model Number	3P	3K	3W	W1-W4	F1-F5
 	30 x 42 x 84	Drum	44BT3084DR18	\$ 4,032	\$ 4,337	\$ 4,358	\$ 5,077	\$ 4,014
	30 x 42 x 90	Drum	44BT3090DR18	4,208	4,557	4,559	5,245	4,333
	30 x 42 x 96	Drum	44BT3096DR18	4,208	4,557	4,572	5,341	4,346
	36 x 48 x 84	Drum	44BT3684DR24	4,343	4,691	4,687	5,423	4,463
	36 x 48 x 90	Drum	44BT3690DR24	4,534	4,932	4,905	5,595	4,587
	36 x 48 x 96	Drum	44BT3696DR24	4,534	4,932	4,919	5,695	4,599

drum bases: **CH** **SH**
NA NA

Primary

- LC**
NA
- QC**
NA
- CH**
NA
- WM**
+125
- WMLC**
+45
- WMLC**
NA
- SH**
+130
- FR**
+300
- PB**
NA
- GR**
+40
- CM**
+50
- RC**
+55
- GN**
NA
- LT**
NA
- AH**
NA
- NU**
NA



Top Size	Base	Model Number	3P	3K	3W	W1-W4	F1-F5	Boat-Shaped with 3 thin disc bases
36 x 48 x 120	Static	99BT36120D243224	\$2,960	\$3,518	\$3,440	\$4,128	3,063	
36 x 48 x 144	Static	99BT36144D243224	3,206	3,863	3,766	4,540	3,116	

3 thin disc bases: **CH** **SH**
NA +195



Top Size	Base	Model Number	3P	3K	3W	W1-W4	F1-F5	Boat-Shaped with 3 disc bases
36 x 48 x 120	Static	44BT36120D243224	\$3,370	\$3,928	\$3,850	\$4,539	3,494	
36 x 48 x 144	Static	44BT36144D243224	3,617	4,273	4,177	4,951	3,547	

3 disc bases: **CH** **SH**
+1200 +195





Top Size	Base	Model Number	3P	3K	3W	W1-W4	F1-F5	Boat-Shaped with 3 drum bases
36 x 48 x 120	Drum	44BT36120DR182418	\$6,438	\$6,995	\$6,917	\$7,606	6,715	
36 x 48 x 144	Drum	44BT36144DR182418	6,684	7,341	7,244	8,018	6,768	



drum bases: **CH** **SH**
NA NA



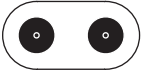

- LC**
NA
- QC**
NA
- CH**
NA
- WM**
+125
- WMLC**
+45
- WMLC**
NA
- SH**
+195
- FR**
+450
- PB**
NA
- GR**
+40
- CM**
+50
- RC**
+55
- GN**
NA
- LT**
NA
- AH**
NA
- NU**
NA

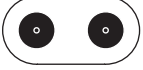
NEW

Racetrack with 2 thin disc bases	Top Size	Base	Model Number	3P	3K	3W	W1-W4	F1-F5
  <p>2 thin disc bases: CH SH NA +130</p>	36 x 72	Static	99RT3672D20	\$ 1,457	\$ 1,683	\$ 1,727	\$ 2,379	\$ 1,717
	36 x 84	Static	99RT3684D20	1,552	1,815	1,859	2,564	1,743
	36 x 90	Static	99RT3690D20	1,742	2,055	2,076	2,724	1,827
	36 x 96	Static	99RT3696D20	1,742	2,055	2,089	2,813	1,833
	42 x 84	Static	99RT4284D24	1,714	2,018	2,039	2,761	1,805
	42 x 90	Static	99RT4290D24	1,893	2,242	2,243	2,929	1,902
	42 x 96	Static	99RT4296D24	1,893	2,242	2,257	3,026	1,914
	48 x 84	Static	99RT4884D32	2,142	2,539	2,498	3,098	2,022
	48 x 90	Static	99RT4890D32	2,210	2,608	2,580	3,270	2,144
	48 x 96	Static	99RT4896D32	2,210	2,608	2,594	3,371	2,157

Racetrack with 2 disc bases	Top Size	Base	Model Number	3P	3K	3W	W1-W4	F1-F5
  <p>2 disc base: CH SH +800 +130</p>	36 x 72	Static	44RT3672D20	\$ 1,691	\$ 1,916	\$ 1,961	\$ 2,612	\$ 1,962
	36 x 84	Static	44RT3684D20	1,785	2,049	2,093	2,797	1,988
	36 x 90	Static	44RT3690D20	1,976	2,288	2,309	2,957	2,072
	36 x 96	Static	44RT3696D20	1,976	2,288	2,323	3,046	2,078
	42 x 84	Static	44RT4284D24	1,968	2,272	2,293	3,015	2,071
	42 x 90	Static	44RT4290D24	2,147	2,495	2,497	3,183	2,168
	42 x 96	Static	44RT4296D24	2,147	2,495	2,511	3,279	2,181
	48 x 84	Static	44RT4884D32	2,455	2,853	2,811	3,412	2,351
	48 x 90	Static	44RT4890D32	2,523	2,921	2,893	3,584	2,473
	48 x 96	Static	44RT4896D32	2,523	2,921	2,907	3,684	2,486

NEW

Racetrack with 2 drum bases	Top Size	Base	Model Number	3P	3K	3W	W1-W4	F1-F5
  <p>drum bases: CH SH NA NA</p>	36 x 72	Drum	44RT3672DR18	\$ 3,832	\$ 4,058	\$ 4,102	\$ 4,754	\$ 4,211
	36 x 84	Drum	44RT3684DR18	3,927	4,190	4,234	4,938	4,236
	36 x 90	Drum	44RT3690DR18	4,117	4,429	4,450	5,099	4,320
	36 x 96	Drum	44RT3696DR18	4,117	4,429	4,464	5,187	4,327
	42 x 84	Drum	44RT4284DR18	4,029	4,334	4,355	5,077	4,236
	42 x 90	Drum	44RT4290DR18	4,208	4,557	4,559	5,245	4,333
	42 x 96	Drum	44RT4296DR18	4,208	4,557	4,572	5,341	4,346
	48 x 84	Drum	44RT4884DR24	4,466	4,864	4,823	5,423	4,463
	48 x 90	Drum	44RT4890DR24	4,534	4,932	4,905	5,595	4,585
	48 x 96	Drum	44RT4896DR24	4,534	4,932	4,919	5,695	4,598

Primary

- LC**
NA
- QC**
NA
- CH**
NA
- WM**
+125
- WMLC**
+45
- WMLC**
NA
- SH**
+130
- FR**
+300
- PB**
NA
- GR**
+40
- CM**
+50
- RC**
NA
- GN**
NA
- LT**
NA
- AH**
NA
- NU**
NA



Top Size	Base	Model Number	3P	3K	3W	W1-W4	F1-F5	Racetrack with 3 thin disc bases
42 x 120	Static	99RT42120D24(3)	\$2,849	\$3,401	\$3,319	\$3,858	\$2,908	
42 x 144	Static	99RT42144D24(3)	3,093	3,743	3,643	4,246	2,929	
48 x 120	Static	99RT48120D32(3)	3,155	3,713	3,635	4,323	3,268	
48 x 144	Static	99RT48144D32(3)	3,402	4,058	3,962	4,735	3,321	

3 thin disc bases: **CH** **SH**
NA +195

Top Size	Base	Model Number	3P	3K	3W	W1-W4	F1-F5	Racetrack with 3 disc bases
42 x 120	Static	44RT42120D24(3)	\$3,230	\$3,782	\$3,700	\$4,239	\$3,308	
42 x 144	Static	44RT42144D24(3)	3,474	4,124	4,024	4,627	3,329	
48 x 120	Static	44RT48120D32(3)	3,625	4,183	4,105	4,793	3,761	
48 x 144	Static	44RT48144D32(3)	3,871	4,528	4,431	5,205	3,814	

3 disc base: **CH** **SH**
+1200 +195



Top Size	Base	Model Number	3P	3K	3W	W1-W4	F1-F5	Racetrack with 3 drum bases
42 x 120	Drum	44RT42120DR18(3)	\$6,322	\$6,875	\$6,793	\$7,331	\$6,555	
42 x 144	Drum	44RT42144DR18(3)	6,566	7,216	7,117	7,720	6,576	
48 x 120	Drum	44RT48120DR24(3)	6,642	7,200	7,122	7,810	6,929	
48 x 144	Drum	44RT48144DR24(3)	6,888	7,545	7,448	8,222	6,982	

drum bases: **CH** **SH**
NA NA



- LC**
NA
- QC**
NA
- CH**
NA
- WM**
+125
- WMLC**
+45
- WMLC**
NA
- SH**
+195
- FR**
+450
- PB**
NA
- GR**
+40
- CM**
+50
- RC**
NA
- GN**
NA
- LT**
NA
- AH**
NA
- NU**
NA

effective January 1, 2019
+5%
add 5% to all list prices



NEW

Elliptical with 2 thin disc bases	Top Size	Base	Model Number	3P	3K	3W	W1-W4	F1-F5
  <p>2 thin disc bases: CH SH NA +130</p>	36 x 72	Static	99EL3672D20	\$ 1,457	\$ 1,683	\$ 1,710	\$ 2,379	\$ 1,587
	36 x 84	Static	99EL3684D20	1,552	1,815	1,836	2,564	1,608
	36 x 90	Static	99EL3690D20	1,742	2,055	2,049	2,724	1,726
	36 x 96	Static	99EL3696D20	1,742	2,055	2,060	2,813	1,751
	42 x 72	Static	99EL4272D24	1,611	1,875	1,884	2,569	1,649
	42 x 84	Static	99EL4284D24	1,714	2,018	2,018	2,761	1,670
	42 x 90	Static	99EL4290D24	1,895	2,244	2,221	2,929	1,763
	42 x 96	Static	99EL4296D24	1,895	2,244	2,232	3,026	1,773
	48 x 84	Static	99EL4884D32	1,940	2,257	2,259	3,098	1,986
	48 x 90	Static	99EL4890D32	2,210	2,608	2,560	3,270	2,100
	48 x 96	Static	99EL4896D32	2,210	2,608	2,571	3,371	2,111

NEW

Elliptical with 2 disc bases	Top Size	Base	Model Number	3P	3K	3W	W1-W4	F1-F5
  <p>2 disc base: CH SH +800 +130</p>	36 x 72	Static	44EL3672D20	\$ 1,691	\$ 1,916	\$ 1,943	\$ 2,612	\$ 1,832
	36 x 84	Static	44EL3684D20	1,785	2,049	2,069	2,797	1,853
	36 x 90	Static	44EL3690D20	1,976	2,288	2,282	2,957	1,971
	36 x 96	Static	44EL3696D20	1,976	2,288	2,293	3,046	1,996
	42 x 72	Static	44EL4272D24	1,865	2,128	2,138	2,823	1,916
	42 x 84	Static	44EL4284D24	1,968	2,272	2,272	3,015	1,937
	42 x 90	Static	44EL4290D24	2,149	2,498	2,475	3,183	2,030
	42 x 96	Static	44EL4296D24	2,149	2,498	2,486	3,279	2,040
	48 x 84	Static	44EL4884D32	2,253	2,570	2,572	3,412	2,315
	48 x 90	Static	44EL4890D32	2,523	2,921	2,873	3,584	2,429
	48 x 96	Static	44EL4896D32	2,523	2,921	2,884	3,684	2,440

NEW

Elliptical with 2 drum bases	Top Size	Base	Model Number	3P	3K	3W	W1-W4	F1-F5
  <p>drum bases: CH SH NA NA</p>	36 x 72	Drum	44EL3672DR18	\$ 3,832	\$ 4,058	\$ 4,084	\$ 4,754	\$ 4,080
	36 x 84	Drum	44EL3684DR18	3,927	4,190	4,210	4,938	4,102
	36 x 90	Drum	44EL3690DR18	4,117	4,429	4,423	5,099	4,219
	36 x 96	Drum	44EL3696DR18	4,117	4,429	4,434	5,187	4,245
	42 x 72	Drum	44EL4272DR18	3,927	4,190	4,199	4,884	4,080
	42 x 84	Drum	44EL4284DR18	4,029	4,334	4,334	5,077	4,102
	42 x 90	Drum	44EL4290DR18	4,210	4,560	4,537	5,245	4,194
	42 x 96	Drum	44EL4296DR18	4,210	4,560	4,548	5,341	4,205
	48 x 84	Drum	44EL4884DR24	4,265	4,582	4,583	5,423	4,427
	48 x 90	Drum	44EL4890DR24	4,535	4,933	4,885	5,595	4,541
	48 x 96	Drum	44EL4896DR24	4,535	4,933	4,895	5,695	4,551

Primary

- LC**
NA
- QC**
NA
- CH**
NA
- WM**
+125
- WMLC**
+45
- WMLC**
NA
- SH**
+130
- FR**
+300
- PB**
NA
- GR**
+40
- CM**
+50
- RC**
NA
- GN**
NA
- LT**
NA
- AH**
NA
- NU**
NA



Top Size	Base	Model Number	3P	3K	3W	W1-W4	F1-F5	Elliptical with 3 thin disc bases
42 x 120	Static	99EL42120D202420	\$2,790	\$3,342	\$3,222	\$3,799	2,846	
42 x 144	Static	99EL42144D202420	3,034	3,684	3,534	4,187	2,867	
48 x 120	Static	99EL48120D243224	2,960	3,518	3,404	4,128	3,063	
48 x 144	Static	99EL48144D243224	3,207	3,863	3,719	4,540	3,116	

3 thin disc bases: **CH** **SH**
NA +195

Top Size	Base	Model Number	3P	3K	3W	W1-W4	F1-F5	Elliptical with 3 disc bases
42 x 120	Static	44EL42120D202420	\$3,150	\$3,703	\$3,582	\$4,159	3,224	
42 x 144	Static	44EL42144D202420	3,394	4,044	3,894	4,548	3,245	
48 x 120	Static	44EL48120D243224	3,371	3,929	3,815	4,539	3,494	
48 x 144	Static	44EL48144D243224	3,617	4,274	4,130	4,951	3,547	



3 disc base: **CH** **SH**
+1200 +195

Top Size	Base	Model Number	3P	3K	3W	W1-W4	F1-F5	Elliptical with 3 drum bases
42 x 120	Drum	44EL42120DR182418	\$6,424	\$6,977	\$6,856	\$7,433	6,662	
42 x 144	Drum	44EL42144DR182418	6,668	7,318	7,168	7,822	6,683	
48 x 120	Drum	44EL48120DR182418	6,438	6,996	6,882	7,606	6,715	
48 x 144	Drum	44EL48144DR182418	6,685	7,341	7,197	8,018	6,768	



drum bases: **CH** **SH**
NA NA



- LC**
NA
- QC**
NA
- CH**
NA
- WM**
+125
- WMLC**
+45
- WMLC**
NA
- SH**
+195
- FR**
+450
- PB**
NA
- GR**
+40
- CM**
+50
- RC**
NA
- GN**
NA
- LT**
NA
- AH**
NA
- NU**
NA

effective January 1, 2019
+5%
add 5% to all list prices



Square with column bases	Top Size	Base	Model Number	3P	3K	3W	W1-W4	F1-F5
 	24 x 24	Static	44SQ2424C2	\$ 478	\$ 517	\$ 599	\$ 729	\$ 528
	30 x 30	Static	44SQ3030C2	530	589	683	840	584
	36 x 36	Static	44SQ3636C2	592	676	779	964	733
	42 x 42	Static	44SQ4242C2	666	779	888	1,098	755
	48 x 48	Static	44SQ4848C2	750	897	1,008	1,241	776
	54 x 54	Static	44SQ5454C2	845	1,030	1,141	1,395	NA
	60 x 60	Static	44SQ6060C2	951	1,179	1,285	1,560	NA

NEW

Square with thin square disc base	Top Size	Base	Model Number	3P	3K	3W	W1-W4	F1-F5
  BL • BLS  Counterbalanced & Short Balanced Height Adj. thin disc base: CH SH NU NA +65 NA	24 x 24	Static	99SQ2424QD16	\$ 572	\$ 610	\$ 692	\$ 822	\$ 626
	30 x 30	Static	99SQ2424QD16BLS	993	1,031	1,113	1,243	1,068
		Short Bal	99SQ3030QD16	623	682	776	934	682
	36 x 36	Static	99SQ3030QD16BLS	1,044	1,103	1,198	1,355	1,124
		Short Bal	99SQ3636QD20	715	799	902	1,086	862
		Count Bal	99SQ3636QD20BLS	1,358	1,441	1,545	1,729	1,537
	42 x 42	Static	99SQ3636QD20BL	1,358	1,441	1,545	1,729	1,537
		Short Bal	99SQ4242QD26	886	999	1,108	1,318	986
		Count Bal	99SQ4242QD26BLS	1,520	1,633	1,742	1,953	1,652
	42 x 42	Short Bal	99SQ4242QD26BL	1,520	1,633	1,742	1,953	1,652
		Count Bal	99SQ4242QD26BL	1,520	1,633	1,742	1,953	1,652

Square with disc base	Top Size	Base	Model Number	3P	3K	3W	W1-W4	F1-F5
  BL • BLS  Counterbalanced & Short Balanced Height Adj. disc base: CH SH +400 +65	24 x 24	Static	44SQ2424D20	\$ 688	\$ 727	\$ 809	\$ 939	\$ 748
	30 x 30	Static	44SQ2424D20BLS	1,086	1,124	1,206	1,336	1,166
		Short Bal	44SQ3030D24	779	838	933	1,090	846
	36 x 36	Static	44SQ3030D24BLS	1,386	1,445	1,540	1,697	1,484
		Short Bal	44SQ3636D24	842	926	1,029	1,213	996
		Count Bal	44SQ3636D24BLS	1,449	1,533	1,636	1,820	1,633
	42 x 42	Static	44SQ3636D24BL	1,449	1,533	1,636	1,820	1,633
		Short Bal	44SQ4242D32	1,042	1,155	1,264	1,475	1,150
		Count Bal	44SQ4242D32BLS	1,638	1,751	1,860	2,070	1,775
	42 x 42	Short Bal	44SQ4242D32BL	1,638	1,751	1,860	2,070	1,775
		Count Bal	44SQ4242D32BL	1,638	1,751	1,860	2,070	1,775



NEW



Square with drum base	Top Size	Base	Model Number	3P	3K	3W	W1-W4	F1-F5
  drum bases: CH SH NA NA	30 x 30	Drum	44SQ3030DR18	\$ 1,810	\$ 1,869	\$ 1,964	\$ 2,121	\$ 1,929
	36 x 36	Drum	44SQ3636DR18	1,873	1,956	2,060	2,244	2,078
	42 x 42	Drum	44SQ4242DR24	2,048	2,161	2,270	2,481	2,206
	48 x 48	Drum	44SQ4848DR24	2,132	2,279	2,391	2,623	2,227
	54 x 54	Drum	44SQ5454DR28	2,560	2,745	2,856	3,109	NA
	60 x 60	Drum	44SQ6060DR28	2,666	2,894	3,000	3,275	NA
		Drum	44SQ6060DR28	2,666	2,894	3,000	3,275	NA



Primary



- LC**
+90
- QC**
+140
- CH**
+100
- WM**
+125
- WMLC**
+45
- MMLC**
+55
- SH**
D+65
C+260
- FR**
+150
- PB**
+55
- GR**
+40
- CM**
+50
- RC**
+55
- GN**
+40
- LT**
+115
- AH**
D+125
C+500
- NU**
D+350



Top Size	Base	Model Number	3P	3K	3W	W1-W4	F1-F5	Round with column bases
24 x 24	Static	44RD24C2	\$ 510	\$ 561	\$ 610	\$ 937	\$ 528	 
30 x 30	Static	44RD30C2	580	659	709	1,117	584	
36 x 36	Static	44RD36C2	654	762	811	1,318	733	
42 x 42	Static	44RD42C2	751	899	940	1,537	755	
48 x 48	Static	44RD48C2	779	937	992	1,775	776	
54 x 54	Static	44RD54C2	938	1,160	1,189	2,037	NA	
60 x 60	Static	44RD60C2	960	1,191	1,236	2,314	NA	

Top Size	Base	Model Number	3P	3K	3W	W1-W4	F1-F5	Round with thin disc base
24 x 24	Static	99RD24D20	\$ 603	\$ 654	\$ 703	\$ 1,030	\$ 626	  <div style="border: 1px solid black; padding: 5px; margin-top: 10px;"> BL • BLS <small>Counterbalanced & Short Balanced Height Adj.</small> </div> <div style="margin-top: 10px;"> thin disc base: CH SH NU NA +65 NA </div>
	Short Bal	99RD24D20BLS	1,025	1,076	1,124	1,451	1,068	
30 x 30	Static	99RD30D20	673	752	802	1,211	682	
	Short Bal	99RD30D20BLS	1,094	1,173	1,223	1,632	1,124	
36 x 36	Static	99RD36D20	747	855	904	1,411	831	
	Short Bal	99RD36D20BLS	1,168	1,277	1,326	1,832	1,274	
	Count Bal	99RD36D20BL	1,168	1,277	1,326	1,832	1,274	
42 x 42	Static	99RD42D24	874	1,021	1,063	1,660	883	
	Short Bal	99RD42D24BLS	1,517	1,664	1,706	2,302	1,558	
	Count Bal	99RD42D24BL	1,517	1,664	1,706	2,302	1,558	
48 x 48	Static	99RD48D32	999	1,157	1,212	1,996	1,007	
	Short Bal	99RD48D32BLS	1,633	1,792	1,847	2,630	1,673	
	Count Bal	99RD48D32BL	1,633	1,792	1,847	2,630	1,673	

Top Size	Base	Model Number	3P	3K	3W	W1-W4	F1-F5	Round with disc base
24 x 24	Static	44RD24D20	\$ 720	\$ 771	\$ 820	\$ 1,146	\$ 748	  <div style="border: 1px solid black; padding: 5px; margin-top: 10px;"> BL • BLS <small>Counterbalanced & Short Balanced Height Adj.</small> </div> <div style="margin-top: 10px;"> disc base: CH SH +400 +65 </div>
	Short Bal	44RD24D20BLS	1,118	1,169	1,218	1,544	1,166	
30 x 30	Static	44RD30D20	790	869	918	1,327	804	
	Short Bal	44RD30D20BLS	1,188	1,267	1,316	1,725	1,222	
36 x 36	Static	44RD36D20	863	972	1,021	1,527	954	
	Short Bal	44RD36D20BLS	1,261	1,370	1,419	1,925	1,372	
	Count Bal	44RD36D20BL	1,261	1,370	1,419	1,925	1,372	
42 x 42	Static	44RD42D24	1,001	1,148	1,190	1,787	1,017	
	Short Bal	44RD42D24BLS	1,608	1,755	1,797	2,394	1,654	
	Count Bal	44RD42D24BL	1,608	1,755	1,797	2,394	1,654	
48 x 48	Static	44RD48D32	1,155	1,314	1,369	2,152	1,171	
	Short Bal	44RD48D32BLS	1,751	1,909	1,964	2,747	1,796	
	Count Bal	44RD48D32BL	1,751	1,909	1,964	2,747	1,796	

Top Size	Base	Model Number	3P	3K	3W	W1-W4	F1-F5	Round with drum base
30 x 30	Drum	44RD30DR18	\$ 1,860	\$ 1,939	\$ 1,989	\$ 2,398	\$ 1,929	  <div style="border: 1px solid black; padding: 5px; margin-top: 10px;"> drum bases: CH SH NA NA </div>
36 x 36	Drum	44RD36DR18	1,934	2,043	2,092	2,598	2,078	
42 x 42	Drum	44RD42DR24	2,134	2,281	2,323	2,919	2,206	
48 x 48	Drum	44RD48DR24	2,161	2,319	2,375	3,158	2,227	
54 x 54	Drum	44RD54DR24	2,320	2,543	2,572	3,419	NA	
60 x 60	Drum	44RD60DR28	2,675	2,906	2,950	4,029	NA	

X online updates
 new product
 clarification / edit
 deletion

effective January 1, 2019
+5%
 add 5% to all list prices

- LC**
+90
- QC**
+140
- CH**
+100
- WM**
+125
- WMLC**
+45
- WMLC**
+55
- SH**
D+65
C+260
- FR**
+150
- PB**
+55
- GR**
+40
- CM**
+50
- RC**
NA
- GN**
NA
- LT**
+115
- AH**
D+125
C+500
- NU**
D+350

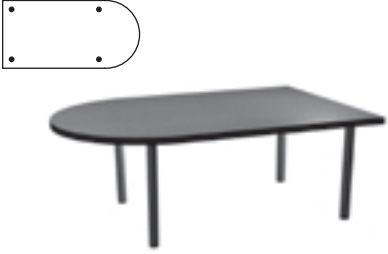
D-shaped with column bases	Top Size	Base	Model Number	3P	3K	3W	W1-W4	F1-F5
	24 x 36	Static	44D2436C2	\$ 570	\$ 645	\$ 715	\$ 1,006	\$ 618
	24 x 48	Static	44D2448C2	632	732	812	1,141	690
	24 x 60	Static	44D2460C2	695	820	908	1,275	763
	24 x 72	Static	44D2472C2	757	907	1,005	1,410	836
	24 x 84	Static	44D2484C2	888	1,063	1,169	1,613	981
	24 x 90	Static	44D2490C2	919	1,107	1,217	1,682	1,017
	24 x 96	Static	44D2496C2	951	1,151	1,266	1,751	1,054
	30 x 48	Static	44D3048C2	695	820	891	1,237	763
	30 x 60	Static	44D3060C2	773	929	1,005	1,383	833
	30 x 72	Static	44D3072C2	851	1,039	1,119	1,529	946
	30 x 84	Static	44D3084C2	998	1,216	1,301	1,744	1,108
	30 x 90	Static	44D3090C2	1,036	1,271	1,357	1,817	1,154
	30 x 96	Static	44D3096C2	1,076	1,325	1,414	1,890	1,200
	36 x 48	Static	44D3648C2	757	907	971	1,333	836
	36 x 60	Static	44D3660C2	851	1,039	1,102	1,491	946
	36 x 72	Static	44D3672C2	945	1,170	1,233	1,645	1,050
	36 x 84	Static	44D3684C2	1,107	1,369	1,432	1,871	1,143
	36 x 90	Static	44D3690C2	1,154	1,435	1,497	1,951	1,297
36 x 96	Static	44D3696C2	1,200	1,500	1,562	2,028	1,307	

NEW

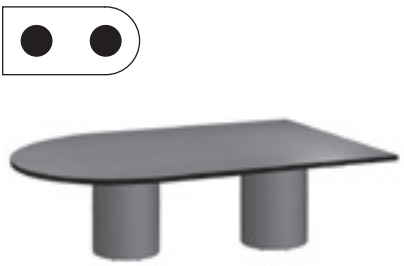
D-shaped with 2 drum bases	Top Size	Base	Model Number	3P	3K	3W	W1-W4	F1-F5
	30 x 60	Drum	44D3060DR18	\$3,659	\$3,815	\$3,891	\$4,269	\$3,863
	30 x 72	Drum	44D3072DR18	3,737	3,924	4,004	4,415	3,976
	30 x 84	Drum	44D3084DR18	3,883	4,102	4,186	4,629	4,138
	30 x 90	Drum	44D3090DR18	3,922	4,157	4,243	4,702	4,184
	30 x 96	Drum	44D3096DR18	3,961	4,211	4,300	4,775	4,230
	36 x 72	Drum	44D3672DR18	3,831	4,056	4,118	4,530	4,080
	36 x 84	Drum	44D3684DR18	3,992	4,255	4,317	4,756	4,173
	36 x 90	Drum	44D3690DR18	4,039	4,321	4,383	4,837	4,327
	36 x 96	Drum	44D3696DR18	4,086	4,386	4,448	4,914	4,337
	42 x 72	Drum	44D4272DR24	4,128	4,391	4,436	4,853	4,294
	42 x 84	Drum	44D4284DR24	4,406	4,753	4,763	5,087	4,387
	42 x 90	Drum	44D4290DR24	4,468	4,839	4,845	5,172	4,408
	42 x 96	Drum	44D4296DR24	4,530	4,926	4,927	5,256	4,551
	48 x 72	Drum	44D4872DR24	4,222	4,522	4,550	4,969	4,406
	48 x 84	Drum	44D4884DR24	4,415	4,765	4,783	5,218	4,499
	48 x 90	Drum	44D4890DR24	4,477	4,852	4,866	5,395	4,541
	48 x 96	Drum	44D4896DR24	4,540	4,940	4,949	5,395	4,551

drum bases: **CH** **SH**
quote NA

Primary

- LC**
+90
- QC**
+140
- CH**
+100
- WM**
+125
- WMLC**
+45
- MMLC**
+55
- SH**
+260
- FR**
NA
- PB**
NA
- GR**
+40
- CM**
+50
- RC**
+55
- GN**
+40
- LT**
NA
- AH**
+500
- NU**
NA



Top Size	Base	Model Number	3P	3K	3W	W1-W4	F1-F5	D-shaped with 2 thin disc bases	NEW
24 x 60	Static	99D2460D20	\$ 1,206	\$ 1,331	\$ 1,419	\$ 1,786	\$ 1,300		
24 x 72	Static	99D2472D20	1,269	1,419	1,516	1,921	1,373		
24 x 84	Static	99D2484D20	1,399	1,574	1,680	2,124	1,517		
24 x 90	Static	99D2490D20	1,430	1,618	1,729	2,193	1,554		
24 x 96	Static	99D2496D20	1,462	1,662	1,777	2,262	1,590		
30 x 60	Static	99D3060D20	1,284	1,441	1,516	1,894	1,370		
30 x 72	Static	99D3072D20	1,362	1,550	1,630	2,040	1,482		
30 x 84	Static	99D3084D20	1,509	1,727	1,812	2,255	1,645		
30 x 90	Static	99D3090D20	1,548	1,782	1,868	2,328	1,691		
30 x 96	Static	99D3096D20	1,587	1,837	1,925	2,401	1,736		
36 x 72	Static	99D3672D24	1,515	1,740	1,803	2,215	1,649		
36 x 84	Static	99D3684D24	1,677	1,939	2,002	2,441	1,742		
36 x 90	Static	99D3690D24	1,724	2,005	2,067	2,521	1,896		
36 x 96	Static	99D3696D24	1,771	2,071	2,133	2,598	1,906		
42 x 72	Static	99D4272D32	1,804	2,066	2,112	2,529	1,854		
42 x 84	Static	99D4284D32	2,082	2,428	2,438	2,763	1,946		
42 x 90	Static	99D4290D32	2,144	2,515	2,521	2,847	1,968		
42 x 96	Static	99D4296D32	2,206	2,602	2,602	2,932	2,111		

2 thin disc bases: **CH** **SH**
NA +130

Top Size	Base	Model Number	3P	3K	3W	W1-W4	F1-F5	D-shaped with 2 disc bases	NEW
24 x 60	Static	44D2460D20	\$ 1,439	\$ 1,564	\$ 1,653	\$ 2,020	\$ 1,545		
24 x 72	Static	44D2472D20	1,502	1,652	1,749	2,154	1,618		
24 x 84	Static	44D2484D20	1,632	1,807	1,914	2,357	1,762		
24 x 90	Static	44D2490D20	1,664	1,851	1,962	2,426	1,799		
24 x 96	Static	44D2496D20	1,695	1,895	2,010	2,496	1,835		
30 x 60	Static	44D3060D20	1,518	1,674	1,750	2,127	1,614		
30 x 72	Static	44D3072D20	1,596	1,783	1,863	2,274	1,727		
30 x 84	Static	44D3084D20	1,742	1,961	2,045	2,488	1,890		
30 x 90	Static	44D3090D20	1,781	2,015	2,102	2,561	1,936		
30 x 96	Static	44D3096D20	1,820	2,070	2,158	2,634	1,981		
36 x 72	Static	44D3672D24	1,769	1,994	2,057	2,469	1,916		
36 x 84	Static	44D3684D24	1,931	2,193	2,256	2,695	2,008		
36 x 90	Static	44D3690D24	1,978	2,259	2,321	2,775	2,162		
36 x 96	Static	44D3696D24	2,025	2,325	2,387	2,852	2,173		
42 x 72	Static	44D4272D32	2,117	2,379	2,425	2,842	2,182		
42 x 84	Static	44D4284D32	2,395	2,741	2,751	3,076	2,275		
42 x 90	Static	44D4290D32	2,457	2,828	2,834	3,160	2,296		
42 x 96	Static	44D4296D32	2,519	2,915	2,915	3,245	2,440		

2 disc base: **CH** **SH**
+800 +130

Primary

effective January 1, 2019
+5%
add 5% to all list prices

- LC**
NA
- QC**
NA
- CH**
NA
- WM**
+125
- WMLC**
+45
- WMLC**
NA
- SH**
+130
- FR**
+300
- PB**
NA
- GR**
+40
- CM**
+50
- RC**
+55
- GN**
+40
- LT**
NA
- AH**
NA
- NU**
NA

Half Round with column bases	Top Size	Base	Model Number	3P	3K	3W	W1-W4	F1-F5
	18 x 36	Static	44HR1836C2(3)	\$ 497	\$ 576	\$ 624	\$ 1,075	\$ 478
	24 x 48	Static	44HR2448C2(3)	554	655	722	1,375	605
	30 x 60	Static	44HR3060C2	774	931	992	1,775	855
	36 x 72	Static	44HR3672C2	944	1,168	1,214	2,122	1,055

Crescent with column bases	Top Size	Base	Model Number	3P	3K	3W	W1-W4	F1-F5
	24 x 48 x 75	Static	44CS2475C2	\$ 1,245	\$ 1,563	\$ 1,511	\$ 1,847	\$ 1,613
	24 x 60 x 94	Static	44CS2494C2	1,568	2,016	1,916	2,124	1,613
	30 x 60 x 94	Static	44CS3094C2	1,568	2,016	1,913	2,282	1,613

Trapezoid with column bases	Top Size	Base	Model Number	3P	3K	3W	W1-W4	F1-F5
	24 x 48	Static	44TZ2448C2	\$ 627	\$ 725	\$ 790	\$ 1,237	\$ 690
	24 x 72	Static	44TZ2472C2	854	1,015	1,088	1,643	908
	30 x 60	Static	44TZ3060C2	801	941	1,009	1,613	926
	36 x 72	Static	44TZ3672C2	990	1,205	1,251	1,955	1,127

Corner with column bases	Top Size	Base	Model Number	3P	3K	3W	W1-W4	F1-F5
	24 x 42	Static	44CR2442C2(5)	\$ 884	\$ 1,052	\$ 1,111	\$ 1,768	\$ 739
	30 x 48	Static	44CR3048C2(5)	917	1,098	1,175	2,041	849

5 bases: **LC** **QC** **SH** **CH**
 +113 +175 +325 +125

Primary

- LC**
+90
- QC**
+140
- CH**
+100
- WM**
+125
- WMLC**
+45
- MMLC**
+55
- SH**
+260
- FR**
NA
- PB**
NA
- GR**
+40
- CM**
+50
- RC**
+55
- GN**
+40
- LT**
+115
- AH**
+500
- NU**
NA



Top Size	Base	Model Number	3P	3K	3W	W1-W4	F1-F5	Arc Segment with column bases
20 x 44	Static	44AS2044C2	\$ 660	\$ 771	\$ 803	NA	\$ 622	
24 x 51	Static	44AS2451C2	730	868	896	NA	715	
30 x 59	Static	44AS3059C2	867	1,034	1,065	NA	926	
36 x 67	Static	44AS3667C2	1,034	1,267	1,290	NA	1,127	

Top Size	Base	Model Number	3P	3K	3W	W1-W4	F1-F5	Ganging Quarter Round (with column*)
20 x 20	Ganging	QR2020GN	\$ 224	\$ 272	\$ 319	NA	\$ 236	
24 x 24	Ganging	QR2424GN	233	284	344	NA	236	
30 x 30	Static, GN	44QR3030GNC2	382	461	526	NA	377	
	Ganging	QR3030GN	301	380	444	NA	292	
36 x 36	Static, GN	44QR3636GNC2	446	551	621	NA	527	
	Ganging	QR3636GN	365	469	540	NA	442	

1 column base: **LC** **QC** **CH** **SH**
 NA +35 +25 +65



Top Size	Base	Model Number	3P	3K	3W	W1-W4	F1-F5	Ganging 45° Wedge (with column*)
20 x 20	Ganging	WG45D20GN	\$ 224	\$ 272	\$ 315	NA	\$ 236	
24 x 24	Ganging	WG45D24GN	233	284	337	NA	236	
30 x 30	Ganging	WG45D30GN	301	380	432	NA	292	
36 x 36	Static, GN	44WG45D36GNC2	446	551	602	NA	527	
	Ganging	WG45D36GN	365	469	520	NA	442	

1 column base: **LC** **QC** **CH** **SH**
 NA +35 +25 +65



Top Size	Base	Model Number	3P	3K	3W	W1-W4	F1-F5	Ganging 60° Wedge (with column*)
20 x 20	Ganging	WG60D20GN	\$ 246	\$ 302	\$ 343	NA	\$ 236	
24 x 24	Ganging	WG60D24GN	254	314	366	NA	236	
30 x 30	Static, GN	44WG60D30GNC2	404	491	543	NA	377	
	Ganging	WG60D30GN	322	410	462	NA	292	
36 x 36	Static, GN	44WG60D36GNC2	468	580	634	NA	527	
	Ganging	WG30D36GN	386	499	553	NA	442	



1 column base: **LC** **QC** **CH** **SH**
 NA +35 +25 +65







Primary





- LC**
+90
- QC**
+140
- CH**
+100
- WM**
+125
- WMLC**
+45
- MMLC**
+55
- SH**
+260
- FR**
NA
- PB**
NA
- GR**
+40
- CM**
+50
- RC**
+55
- GN**
+40
- LT**
+115
- AH**
+500
- NU**
NA

Video Wedge with column bases	Top Size	Base	Model Number	3P	3K	3W	W1-W4	F1-F5
 	20 x 20 x 40	Static	44VW2040C2	\$ 617	\$ 711	\$ 771	NA	\$ 601
	24 x 24 x 48	Static	44VW2448C2	660	771	844	NA	690
	30 x 30 x 60	Static	44VW3060C2	867	1,034	1,104	NA	926
	36 x 36 x 72	Static	44VW3672C2	1,117	1,383	1,418	NA	1,127

10° Transition with column bases	Top Size	Base	Model Number	3P	3K	3W	W1-W4	F1-F5
 	20 x 30	Static	44TN2030C2	\$ 521	\$ 577	\$ 643	NA	\$ 551
	24 x 30	Static	44TN2430C2	532	592	662	NA	581
	30 x 30	Static	44TN3030C2	588	670	735	NA	627
	36 x 30	Static	44TN3630C2	652	759	817	NA	672

Trident with column bases	Top Size	Base	Model Number	3P	3K	3W	W1-W4	F1-F5
 	36 x 36 x 18	Static	44TR3618C2(6)	\$ 1,025	\$ 1,218	\$ 1,201	\$ 1,557	\$ 910
	40 x 40 x 20	Static	44TR4020C2(6)	1,131	1,365	1,331	1,680	1,175
	48 x 48 x 24	Static	44TR4824C2(6)	1,144	1,384	1,374	1,953	1,175
	60 x 60 x 30	Static	44TR6030C2(6)	1,331	1,646	1,623	2,388	NA

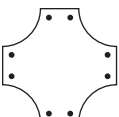
6 bases: **LC** **QC** **SH** **CH** **AH**
 +135 +210 +390 +150 NA



Quadrant with column bases	Top Size	Base	Model Number	3P	3K	3W	W1-W4	F1-F5
 	60 x 60 x 18	Static	44QD6018C2(8)	\$ 1,537	\$ 1,869	\$ 1,855	\$ 2,708	\$ NA
	60 x 60 x 20	Static	44QD6020C2(8)	1,537	1,869	1,857	2,708	NA
	60 x 60 x 24	Static	44QD6024C2(8)	1,537	1,869	1,861	2,708	NA
	60 x 60 x 30	Static	44QD6030C2(8)	1,537	1,869	1,867	2,708	NA



8 bases: **LC** **QC** **SH** **CH** **AH**
 +180 +280 +520 +200 NA



Primary



- LC**
+90
- QC**
+140
- CH**
+100
- WM**
+125
- WMLC**
+45
- MMLC**
+55
- SH**
+260
- FR**
NA
- PB**
NA
- GR**
+40
- CM**
+50
- RC**
+55
- GN**
+40
- LT**
+115
- AH**
+500
- NU**
NA





Top Size	Base	Model Number	3P	3K	3W	W1-W4	F1-F5	Bulb with column bases
24 x 24 x 18	Static	44BU2418C2	\$ 710	\$ 841	\$ 834	\$1,302	\$ 545	 
30 x 30 x 20	Static	44BU3020C2	749	895	900	1,560	627	
36 x 36 x 24	Static	44BU3624C2	854	1,043	1,039	1,825	727	
42 x 42 x 30	Static	44BU4230C2	951	1,179	1,168	2,110	845	
48 x 48 x 36	Static	44BU4836C2	964	1,197	1,205	2,399	982	

Top Size	Base	Model Number	3P	3K	3W	W1-W4	F1-F5	Squire with column bases
24 x 24	Static	44SL24C2	\$ 663	\$ 776	\$ 802	NA	\$ 528	 
30 x 30	Static	44SL30C2	712	844	883	NA	584	
36 x 36	Static	44SL36C2	766	919	971	NA	733	
42 x 42	Static	44SL42C2	825	1,002	1,063	NA	755	
48 x 48	Static	44SL48C2	896	1,101	1,169	NA	776	

Top Size	Base	Model Number	3P	3K	3W	W1-W4	F1-F5	Squire with thin squire disc base
24 x 24	Static	99SL24SD16	\$ 757	\$ 869	\$ 895	NA	\$ 626	  <div style="border: 1px solid black; padding: 5px; margin-top: 10px;"> <p>thin disc base: CH NA SH +65 NU NA</p> </div> <div style="border: 1px solid black; padding: 5px; margin-top: 10px;"> <p>BL • BLS Counterbalanced & Short Balanced Height Adj.</p> </div>
	Short Bal	99SL24SD16BLS	1,178	1,290	1,317	NA	1,068	
30 x 30	Static	99SL30SD16	805	937	977	NA	682	
	Short Bal	99SL30SD16BLS	1,226	1,358	1,398	NA	1,124	
36 x 36	Static	99SL36SD20	889	1,042	1,093	NA	862	
	Short Bal	99SL36SD20BLS	1,531	1,685	1,736	NA	1,537	
	Count Bal	99SL36SD20BL	1,531	1,685	1,736	NA	1,537	
42 x 42	Static	99SL42SD26	1,045	1,222	1,283	NA	986	
	Short Bal	99SL42SD26BLS	1,680	1,857	1,918	NA	1,652	
	Count Bal	99SL42SD26BL	1,680	1,857	1,918	NA	1,652	

Top Size	Base	Model Number	3P	3K	3W	W1-W4	F1-F5	Teardrop with column bases
24 x 48	Static	44TE2448C2	\$ 804	\$ 972	\$ 1,032	NA	693	 

Top Size	Base	Model Number	3P	3K	3W	W1-W4	F1-F5	Table Desk with column bases
37 x 60	Static	44TA3760C2	\$ 913	\$ 1,099	\$ 1,206	\$ 1,897	\$ 1,032	 
42 x 78	Static	44TA4278C2	1,168	1,455	1,545	2,321	1,364	

- LC**
+90
- QC**
+140
- CH**
+100
- WM**
+125
- WMLC**
+45
- MMLC**
+55
- SH**
+260
- FR**
NA
- PB**
NA
- GR**
+40
- CM**
+50
- RC**
+55
- GN**
+40
- LT**
+115
- AH**
+500
- NU**
NA

