



Levels

Box Beam Levels.....2-3
 I-Box® Levels.....4
 I-Beam Levels.....5-6
 Top Read Levels.....5
 Speedlite® Levels.....7
 Torpedo Levels.....7-10
 Specialty Levels.....11

Squares®

Speed® Squares.....12-13
 Speedlite® Squares.....14
 The Big® 12 Speedlite® Squares.....14
 Speed® Bevel Speed® Squares.....14
 Wizard® Folding Framing Squares.....15
 Combination Square.....15
 Speedlite® Combination Square.....15
 Pro Combination Square.....15
 Builder's Squares.....16-17
 Wallboard Squares.....18

Accessories

Straight Edges.....19
 Tape Measures.....20
 Compact Measuring Wheels.....20
 Carpenter Pencils & Refills.....21
 Saws.....21
 Plumb Bobs.....22
 Stair Gauges.....22
 Blue Book of Instructions.....22
 Hinge Butt Marker.....22

Factory Direct Distributor Pricing or Better!

 **WARNING:** Cancer and/or reproductive harm - www.P65Warnings.ca.gov
 ALL ITEMS WITHIN

Lighted Box Beam Levels

- End caps provide maximum shock absorption
- V-grooved edge for working with round stock
- Comfort grips for easy handling
- Durable block vials accurate to .00050/in.
- Professional box beam frame offers maximum durability
- Super Bright LEDs simultaneously light all 3 vials for low-light areas
- Available in magnetic model (BLL24M, BLL48M), with IMS Technology™ Magnetic System-6 super strong earth magnets

MFR #	Length	Std Pk	Control #
BLL240	24"	3	
BLL480	48"	3	
BLL24M	24" Magnetic	3	
BLL48M	48" Magnetic	3	



BLL240

Aluminum Box Beam Levels

- Deep accurized V-groove for round and square stock
- Multi-ring vials indicate 2° and 4° grade for drainage
- Super Shock® end caps
- Cushion-grip hand grips
- Precision milled edges
- Superior heavy-duty aluminum frame for maximum durability
- Durable block vials accurate to .00050/in.
- Available in magnetic model (BBL24M, BBL48M), with IMS Technology™ Magnetic System-6 super strong earth magnets

MFR #	Length	Std Pk	Control #
BBL240	24"	3	
BBL480	48"	3	
BBL720	72"	3	
BBL24M	24" Magnetic	3	
BBL48M	48" Magnetic	3	



BBL240

Professional Series Levels



Box Beam

Professional Box Beam Levels with Gelshock™ End Caps

- Continuous dual rail frame
- .029° vial accuracy
- Precision machined
- Gelshock™ end caps
- Diamond® bumpers eliminate marring
- 80% stronger Savage™ strength frame
- Acrylic block vials
- Multi-ring vials
- Available in magnetic model (SVB24M-SVB96M)

MFR #	Length	Std Pk	Control #
SVB180	18"	3	
SVB240	24"	3	
SVB320	32"	3	
SVB360	36"	3	
SVB480	48"	3	
SVB540	54"	3	
SVB600	60"	3	
SVB720	72"	1	
* SVB960	96"	1	
SVB24M	24" Magnetic	3	
SVB32M	32" Magnetic	3	
SVB36M	36" Magnetic	3	
SVB48M	48" Magnetic	3	
SVB78M	78" Magnetic	1	
* SVB96M	96" Magnetic	1	

* FOB - Houston GFL Dock Only Due to Overlength

Lightning® Box Beam Luminated Levels

- Continuous dual rail frame
- .029° vial accuracy
- Precision machined
- Super Shock® end caps
- Diamond® bumpers eliminate marring
- 80% stronger Savage™ strength frame
- Acrylic block vials
- Multi-ring vials

MFR #	Length	Std Pk	Control #
SVLB24	24"	3	
SVLB48	48"	3	

Professional Box Beam Level Kits with Gelshock™ End Caps

- Contractor Value Kit (SVBCK0) - Professional Box Beam Levels
- Jamber Kit (SVBJKM) - Magnetic Professional Box Beam Levels
- Tub Surround Kit (SVBTS0) - Professional Box Beam Levels

MFR #	Length	Std Pk	Control #
SVBCK0	24", 48", 78"	1	
SVBJKM	32", 78" Magnetic	1	
SVBTS0	32", 54"	1	





I-Box® Levels

- Exclusive Diamond™ Designs are raised slightly to avoid surface scratches
- Multi-ring vials indicate 2° and 4° grade for drainage
- Super Shock® end caps
- Precision milled edges
- Durable block vials accurate to .00050/in.
- Available in magnetic model (IBX24M, IBX48M)

MFR #	Length	Std Pk	Control #
IBX240	24"	3	
IBX480	48"	3	
IBX24M	24" Magnetic	3	
IBX48M	48" Magnetic	3	



I-Box® Levels

- Precision-milled, extruded heavy-duty aluminum frame for maximum durability
- BRIGHTVIEW® reflects light for improved visibility
- Ergonomic, rubberized grips for comfortable, easy handling
- Durable acrylic block vials accurate to .00050 in.
- Available in magnetic model (SWIBX24M, SWIBX48M)

MFR #	Length	Std Pk	Control #
SWIBX240	24"	3	
SWIBX480	48"	3	1520826
SWIBX24M	24" Magnetic	3	
SWIBX48M	48" Magnetic	3	



Levels

I-Beam®



I-Beam® Levels

- V-grooved for working with round stock
- High-grade aluminum frame
- Shock resistant rubber and end caps
- BRIGHTVIEW® reflects light for improved visibility
- Ergonomic, rubberized grips for comfortable, easy handling
- Vials accurate to .029°/.00050 in.
- Available in magnetic model (SWIBL24M - SWIBL78M)

MFR #	Length	Std Pk	Control #
SWIBL240	24"	3	
SWIBL480	48"	3	
SWIBL24M	24" Magnetic	3	1520800
SWIBL48M	48" Magnetic	3	1520801
SWIBL78M	72" Magnetic	3	1520819



SWIBL240

I-Beam® Levels

- V-grooved for working with round stock
- Oversized Vial Port - to improve readability
- Screwed tight vial covers
- Top read vial for an accurate read from all angle
- Heavy duty rubber end caps for superior shock absorption
- Available in magnetic model (IBL24M - IBL78M)

MFR #	Length	Std Pk	Control #
IBL240	24"	3	
IBL480	48"	3	
IBL24M	24" Magnetic	3	
IBL48M	48" Magnetic	3	
IBL78M	78" Magnetic	3	



IBL240

Top Read I-Beam® Levels

- Precision-milled, extruded heavy-duty aluminum frame for maximum durability
- Ruled edge for measuring, includes 1/8 and 1/16 gradations
- V-grooved for working with round stock and pipes
- Durable, acrylic windows protect vials
- Continuous rail for uninterrupted scribe lines
- Top-read center vial for an accurate read in tight spaces
- Vials accurate to .029° .0005 in.

MFR #	Length	Std Pk	Control #
TRL240	24"	3	
TRL480	48"	6	



TRL240

Top Read Aluminum Levels

- V-grooved for working with round stock
- Ruled edge for measuring
- High-grade aluminum frame
- Acrylic windows protect vials from breakage
- Vials accurate to .029°/.00050 in.
- Continuous rail for continuous scribes without frame interruption

MFR #	Length	Std Pk	Control #
SWTRL240	24"	3	
SWTRL360	36"	3	
SWTRL480	48"	6	

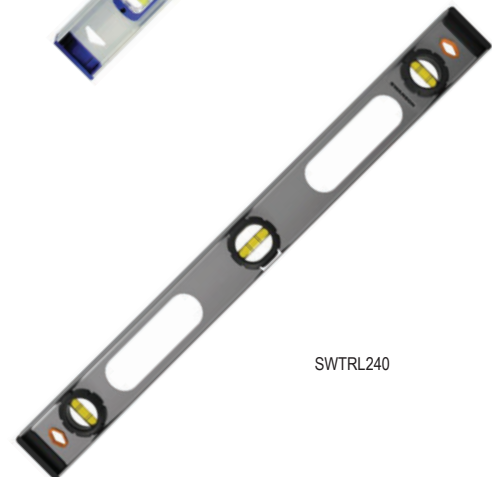

SWTRL240

I-Beam Levels

- .029° vial accuracy
- Precision machined
- Multi-ring vials
- Gel Shock® end caps
- 2X stronger Savage™ strength frame
- Available in magnetic models (SVI24M-SVI78M)

MFR #	Length	Std Pk	Control #
SVI240	24"	3	
SVI480	48"	3	
SVI24M	24" Magnetic	3	
SVI48M	48" Magnetic	3	
SVI78M	78" Magnetic	1	



SVI240

Levels

Speedlite[®], Torpedo



Speedlite[®] Levels

- Durable acrylic windows protect vials
- Three different vials: Plumb, Level, and 45°
- Lightweight composite body
- Cut outs for easy handling
- Ruled edges on the top for easy measuring
- Inches and centimeter (1/8th & mm)



PL0024

MFR #	Length	Std Pk	Control #
PL0024	24"	3	
PL0048	48"	3	

Aluminum Top Read Tool Box Magnetic Level

- Multi-pitch vial reads from level to 1/2 in Pitch in 1/8 in. increments
- Full-length strip magnet
- BRIGHTVIEW[®] reflects light for improved visibility
- Extruded aluminum frame
- V-Grooved for working with round stock and pipes
- 2 Top Read Vials



TBL001M

MFR #	Length	Std Pk	Control #
TBL001M	12" Magnetic	5	

High-Impact Aluminum Magnetic Torpedo Level

- Full length strip magnet
- High grade solid aluminum frame
- High-impact composite inserts
- Easy to read vial windows

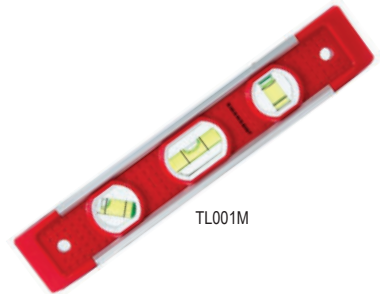

TL001M

MFR #	Length	Std Pk	Control #
TL001M	9" Magnetic	10	

Extruded Aluminum Torpedo Magnetic Level

- 3 incredibly strong rare earth magnets
- High grade aluminum extrusion construction
- High-impact composite inserts
- Easy to read vial windows

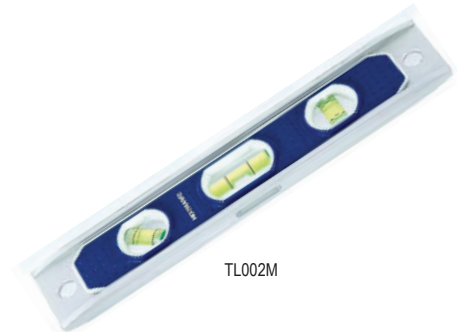

TL002M

MFR #	Length	Std Pk	Control #
TL002M	9" Magnetic	10	

Shock Resistant Magnetic Torpedo Level

- 6 Incredibly strong internally sealed rare earth magnets
- Features IMS Technology™
- Super Shock® end caps
- Durable extruded aluminum frame
- Deep V-grooved for working with round stock and pipes

MFR #	Length	Std Pk	Control #
TL009M	9" Magnetic	6	



TL009M

Lightweight Speedlite® Torpedo Level

- Lightweight and compact design for portability
- Impact-resistant composite body
- Acrylic high visibility vials

MFR #	Length	Std Pk	Control #
TL011	9"	20	1520828



TL011

Shock Absorbing Speedlite® Magnetic Torpedo Level

- Full-length strip magnet
- Top read feature for ease of use in tight spots
- Rubber end caps for shock absorption
- Impact-resistant composite body
- Acrylic high visibility vials

MFR #	Length	Std Pk	Control #
TL021M	9" Magnetic	6	



TL021M

Pro-Cast® Magnetic Torpedo Level

- Milled working surface for precision accuracy
- 4 super strong rare earth magnets
- Heavy-duty acrylic block vials accurate to .00050/in.
- Thermally bonded high-visibility powder coat finish

MFR #	Length	Std Pk	Control #
TL035M	10" Magnetic	6	



TL035M

Levels

Torpedo



Shock-Resistant Magnetic Torpedo Level

- 6 incredibly strong internally sealed rare earth magnets
- Features IMS Technology™
- BRIGHTVIEW® reflects light for improved visibility
- Super Shock® end caps
- Extruded aluminum frame
- V-grooved for working with round stock and pipes



SWTL900M

MFR #	Length	Std Pk	Control #
SWTL900M	9" Magnetic	6	1520817

Extruded Magnetic Torpedo Level

- 3 Incredibly strong rare earth magnets
- BRIGHTVIEW® reflects light for improved visibility
- Extruded aluminum frame
- V-grooved for working with round stock and pipes



SWTL800M

MFR #	Length	Std Pk	Control #
SWTL800M	9" Magnetic	10	1520815

DIY Magnetic Aluminum Torpedo Level

- Durable extruded aluminum frame
- V-grooved, full-length, heavy-duty magnetic strip provides stability and strength when working with round stock and pipes
- Lightweight, compact design for portability carry it in your pocket or tool pouch
- BRIGHTVIEW® reflects light for improved visibility



SWTL700M

MFR #	Length	Std Pk	Control #
SWTL700M	9" Magnetic	10	1520814

Aluminum Tool Box Magnetic Level

- Multi-pitch vial reads from level to 1/2 in. pitch in 1/8 in. increments
- Full-length strip magnet
- BRIGHTVIEW® reflects light for improved visibility
- Extruded aluminum frame
- V-grooved for working with round stock and pipes



SWTBL500M

MFR #	Length	Std Pk	Control #
SWTBL500M	12" Magnetic	6	

Shock Absorbing Magnetic Aluminum Torpedo Level

- 4 strong Neodymium V-grooved magnets
- Solid billet 3X stronger
- BRIGHTVIEW® vial surrounds
- .029° / .0005 in. vial accuracy
- V-grooved edge
- Shock absorbing end caps

MFR #	Length	Std Pk	Control #
SVT011	11" Magnetic	6	1520806



SVT011

Digital Magnetic Torpedo Level

- 4 strong Neodymium V-grooved magnets
- BRIGHTVIEW® vial surrounds
- Audible tones
- Green backlight
- 3 Modes
- 90° & 0° vials
- Precision machined

MFR #	Length	Std Pk	Control #
SVT200	9" Magnetic	6	1520827



SVT200

Magnetic Aluminum Torpedo Level with Conduit Clamps

- Tri-Loc® conduit clamp
- 4 strong Neodymium magnets
- Solid billet 3X stronger
- 4 leveling vials for conduit bends
- BRIGHTVIEW® vial surrounds
- .029° / .0005° / in. vial accuracy
- Acrylic vials are extremely durable

MFR #	Length	Std Pk	Control #
TL041M	6" Magnetic	6	1520807

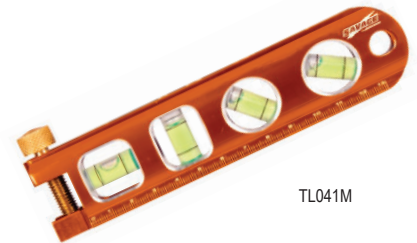

TL041M

Magnetic Aluminum Torpedo Level

- 4 strong Neodymium magnets
- Solid billet 3X stronger
- 4 leveling vials for conduit bends
- BRIGHTVIEW® vial surrounds
- .029° / .0005° / in. vial accuracy
- Acrylic vials are extremely durable

MFR #	Length	Std Pk	Control #
TL043M	9" Magnetic	6	1520808

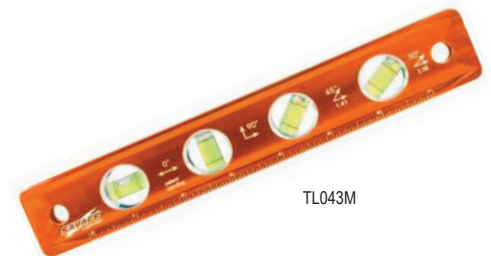

TL043M

Lighting Aluminum Magnetic Torpedo Level

- 4 strong Neodymium magnets
- Vial lighted system
- Solid billet 3X stronger
- BRIGHTVIEW® vial surrounds
- .029° / .0005 in. vial accuracy
- 10 minute shut-off
- V-grooved edge
- Includes 2 CR2032 batteries

MFR #	Length	Std Pk	Control #
TLL049M	9" Magnetic	6	1520809



TLL049M

Levels

Specialty Levels



Magnetic Angle Finder

- Determine any angle quickly
- Can be used with a straight edge or carpenter square for fast layout
- Block magnetic base
- High-grade composite construction
- V-grooved edge

MFR #	Dimensions	Std Pk	Control #
AF006M	8 3/8" x 5 1/2"	6	



AF006M

Cross Check Level

- Precision accurate vials in a durable composite housing
- Two mounting holes

MFR #	Dimensions	Std Pk	Control #
CCL001	1 1/2" x 2 1/2"	12	

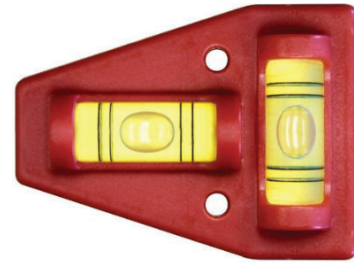

CCL001

Aluminum Line Level

- High-grade aluminum frame
- Snag-free open hooks allow level to slide freely

MFR #	Length	Std Pk	Control #
LLA001	4"	12	1520820



LLA001

Lightweight Speedlite® Line Level

- V-groove for use on pipe or conduit
- 2 pack
- Snag free open hooks allows to slide freely

MFR #	Length	Std Pk	Control #
LLP002	3"	12	1520816



LLP002

Speedlite® Magnetic Post Level

- Strip magnets and elastic strap for hands free work
- Constructed of high impact composite material
- Hands free plumb and level of posts and more

MFR #	Length	Std Pk	Control #
PL001M	8 1/2" x 8 1/2"	10	



PL001M

Surface Level

- Lightweight, composite construction that you can take anywhere
- 3 Pre rounded fastening holes allow you to attach the level to working surface
- Use to level appliances, fence posts, tables and more

MFR #	Diameter	Std Pk	Control #
SL0002	1.75"	12	



SL0002

Wood Magnet®

- Compress fits to any 2X material (2x4, 2x6, etc.)
- Use with square posts, round posts up to 4 in. in diameter
- Levels studs and joists
- 3 easy to read vials
- High impact composite body

MFR #	Length	Std Pk	Control #
T04424	2" x 4"	6	



T04424

Speed[®] Square with Black Markings & Blue Book

- The Speed[®] Square, is essential for every carpenter, construction professional, roofer and DIYer
- Multi-tool: Try square, miter square, saw guide, line scribe, and protractor
- Includes pocket-sized Swanson[®] Blue Book (Comprehensive Reference Guide)
- Features: 1/4 in. spaced scribing notches and the Diamond[®] cutout for easy rafter seat cuts and scribing the most common and popular stud widths
- Gradations included for marking common, hip, valley, and jack rafters. Useful for determining and marking angles and making square cuts on boards
- Heavy-gauge billet aluminum alloy construction is die-cast for increased accuracy over laser-etched and extruded stamped rafter squares
- High-visibility, black gradations with a non-glare, matte finish for easy reading in any lighting conditions
- Available with plain gradations & blue book (T0101)
- Available with Speed Clip (S0101-C)
- Available with bulk display merchandiser contains 20 Speed[®] Squares with plain markings (DB101) and bulk display merchandiser with 12 Speed[®] Squares (tag carded) with Plain Markings & Blue Books (DT101)

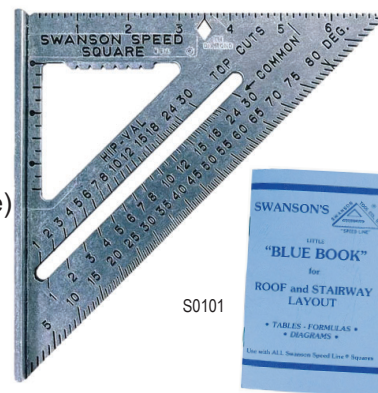

MFR #	Length	Std Pk	Control #
S0101	7"	5	1520802
S0101-C	7"	5	
T0101	7"	5	
DB101	7"	1 Box of 20	
DT101	7"	1 Box of 20	

Speed[®] Square Pro

- 2X longer scribe bar with 1/8 in. increments and the diamond cut out bridge that adds support and the famous trademark Swanson Diamond[™] Cut Out at the 3 in. mark
- 1-1/2 in. EDGE - the width of 2X material - mark both sides of studs
- 22-1/2° ANGLE - coming off of the pivot for quick layouts
- 3 1/2 in. Diamond[™] cutout for working with 2 x 6 material
- Beveled edges get the square closer to the working material resulting in more accurate Top Cut measurements
- Easier to see numbers and markings
- 2 Convenient marking edges for 3/4 in. and 1/2 in.
- High-visibility, black gradations with a non-glare, matte finish for easy reading in any lighting conditions

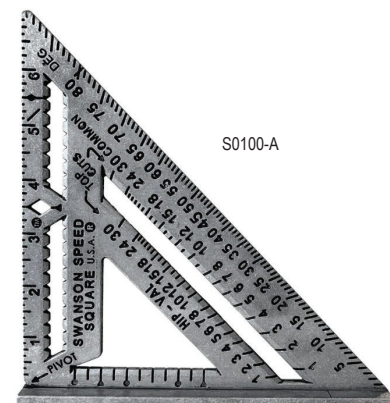

MFR #	Length	Std Pk	Control #
S0100-A	7"	4	

Speed[®] Squares

Trim, Big 12[®], Metric Speed[®] Square



Speed[®] Trim Square

- Swanson[®] Diamond™ 3 1/2 in. mark
- Scribe Bar 1/8 in. marks
- 22-1/2° 30°, 45° and 67 1/2° markings - easy angle finder
- 3/8 in. Drill Guide for self-centering drill bits on 3/4 in. stock
- Dual Reference Base: 1/4 in. & 3/8 in. perfect for centering morises and tenons
- Anti-glare finish
- Easy read markings

MFR #	Length	Std Pk	Control #
S0145	4 1/2"	4	

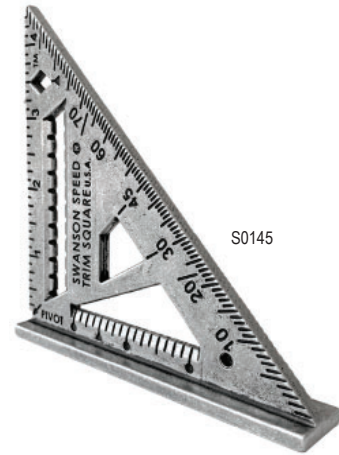

S0145

The Big 12[®] Speed[®] Square

- Seven tools in one: framing square, try square, miter square, protractor, saw guide, stair gauge and out-of-square corner angle finder
- Heavy gauge aluminum
- 1/4 in. and 1/2 in. spaced notches to facilitate scribing lines
- Matte finish to prevent glare
- Black gradations for easy reading
- Great for deck framing and stairway building
- Patented layout bar
- Available without layout bar (T0108)

MFR #	Length	Std Pk	Control #
S0107	12"	5	1520803
T0108	12"	5	1520821

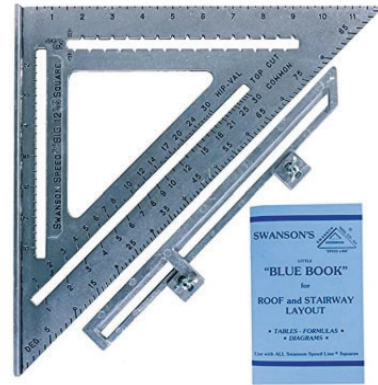

S0107

Metric Speed[®] Square

- Two separate scales for common and hip-valley rafters, metric and degree
- High-grade aluminum alloy construction
- Traditional One-Number MethodSM for rafter layout for easier measuring
- 0.5 cm spaced notches facilitate scribing lines
- Matte finish to prevent glare
- Available with English/German/French packaging and Green Book (EU202) and English/Spanish instruction book (NA202)

MFR #	Length	Std Pk	Control #
EU202	25 cm	5	
NA202	25 cm	5	



EU202

Speedlite® Level Square

- Built-in block vial - Easy to read from all angles
- Beveled edge for ease of reading
- Lightweight high-impact structural composite material
- Great for siding and won't mar finish
- 1/8 in. spaced notches to facilitate scribing lines
- Center line guide for locating center of round stock
- Diamond® cut out for easy layout

MFR #	Length	Color	Std Pk	Control #
T0111	8"	Gray	5	
T0811	8"	Hi-Viz Orange	5	

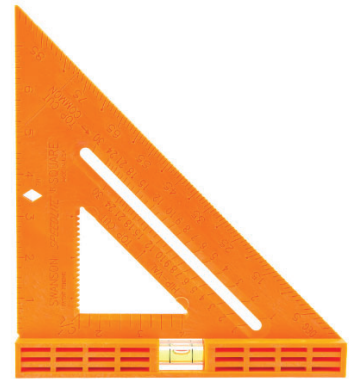

T0811

Speedlite® Square

- 8 in. size is great for siding and larger materials
- Beveled edge for ease of reading
- Construction of lightweight high-impact structural composite material
- Great for siding and won't mar finish
- 1/8 in. spaced notches to facilitate scribing lines
- Center line guide for locating center of round stock

MFR #	Length	Color	Std Pk	Control #
T0112	8"	Gray	5	
T0118	8"	Hi-Viz Orange	5	1520804
T0119	8"	Hi-Viz Yellow	5	

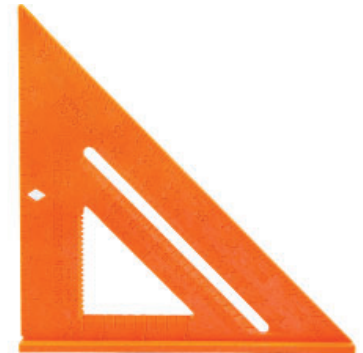

T0118

Big 12® Speedlite® Square

- Beveled edge for ease of reading
- Construction of lightweight high-impact structural composite material
- Great for siding and won't mar finish
- 1/4 in. and 1/2 in. spaced notches to facilitate scribing lines
- Center line guide for locating center of round stock
- Diamond® cut out for easy layout

MFR #	Length	Color	Std Pk	Control #
T0701	12"	Orange	5	1520805

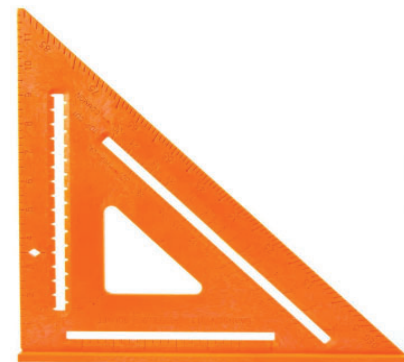

T0701

Speed® Bevel Folding Speed® Square

- 6 Tools in One: Try Square, Miter Square, Rafter Square, Line Scriber, Angle Finder, T-Bevel
- Construction of lightweight high-impact structural composite material
- Won't mar finish
- Folds to only 10-1/4" in. L 2-1/4 in. W and 1 in. D

MFR #	Length	Color	Std Pk	Control #
T0SB01	7"	Orange	5	



T0SB01

Folding & Combination Squares



Folding, Combination, Pro Combination

Wizard® Folding Aluminum Framing Square

- Multi-Tool: Framing Square, Miter Square, Angle Finder, Saw Guide and Try Square
- Durable, high-grade anodized aluminum construction features pitch finder Swanson® Diamond® cutout
- Simultaneously mark top and bottom stud plates
- Portable, compact design folds down to fit into a standard toolbox
- Includes instruction book for using the Swanson® One-Number® Method and an Allen wrench for adjusting the square
- Precision laser etching on high-visibility blue finish creates contrast for easy readings
- Includes Jack rafter/rake wall scales



T001WZ

MFR #	Length	Std Pk	Control #
T001WZ	24"	6	

Pocket Combination Square

- Precision machined die-cast zinc body
- Hi-impact composite head
- Spring loaded, brass bolt assures firm, accurate settings
- Etched stainless steel blade
- Screw fit brass scribe and impact resistant acrylic vial
- 1/8 in., 1/16 in., 1/32 in., and mm scale gradations
- Available in 12" model (TC132)



TC130

MFR #	Length	Std Pk	Control #
TC130	6"	6	

Speedlite® Combination Square

- Spring loaded, brass bolt assures firm, accurate settings
- Stainless steel blades with black precision etchings, includes brass hardware
- Screw fit brass scribe and impact resistant acrylic vial



TC131

MFR #	Length	Color	Std Pk	Control #
TC131	12"	Yellow	6	1520822
TC132	12"	Black	6	

Pro Combination Square

- Precision machined die-cast zinc head
- Spring loaded, brass bolt assures firm, accurate settings
- Stainless steel blades with black precision etchings, includes brass hardware
- Screw fit brass scribe and impact resistant acrylic level vial
- 1/8 in., 1/16 in., 1/32 in. and mm scale gradations



TC134

MFR #	Length	Std Pk	Control #
TC134	16"	6	

Combination Square

- Chemical etching
- Precision machined surfaces
- Stainless steel blade
- Brass tightening bolt and scribe all
- Acrylic block vial
- Savage™ strength frame-aerospace aluminum



SVC133

MFR #	Length	Color	Std Pk	Control #
SVC133	12"	Stainless Steel & Orange	6	1520813





Builder Squares

Carpenter, Rafter

Steel Carpenter Square

- High-grade tempered steel
- Nickel Plated, resists rust
- Reverse-reading scale
- Acid wash for anti-glare matte finish
- Permanently impressed gradations

MFR #	Length	Color	Std Pk	Control #
TS157	16" x 24"	Steel	6	1520824

Aluminum Carpenter Square

- Reverse-reading scale
- 1/8, 1/10, 1/12, 1/16 & 1/100 Scales
- Permanently impressed gradations

MFR #	Length	Color	Std Pk	Control #
TA123	16" x 24"	Aluminum	6	

Carpenter Square

- Lightweight and Durable
- Anodized aerospace aluminum
- Precision laser etching
- Reverse reading scale

MFR #	Length	Color	Std Pk	Control #
SVL123	16" x 24"	Orange	6	1520810



Aluminum Rafter Square

- Rafter, brace & essex tables; octagon scales
- 1/8, 1/10, 1/12, 1/16 & 1/100 Scales
- Permanently impressed gradations

MFR #	Length	Color	Std Pk	Control #
TA122	16" x 24"	Aluminum	6	

Black Anodized Rafter Square

- Highly visible, permanently impressed gradations in 1/8 in., 1/10 in., 1/12 in. and 1/16 in. scale
- 1/16 and 1/100 Scales
- White gradients over black anodizing for easy readability
- Rafter, brace and essex table, octagon scales

MFR #	Length	Color	Std Pk	Control #
TA126	16" x 24"	Black	6	

Heavy-Duty Aluminum Rafter Square

- 3/16 in. thick aluminum alloy
- Rafter, brace & essex tables; octagon scales
- 1/8, 1/10, 1/12, 1/16 & 1/100 Scales
- Permanently impressed gradations

MFR #	Length	Color	Std Pk	Control #
TA127	16" x 24"	Aluminum	6	

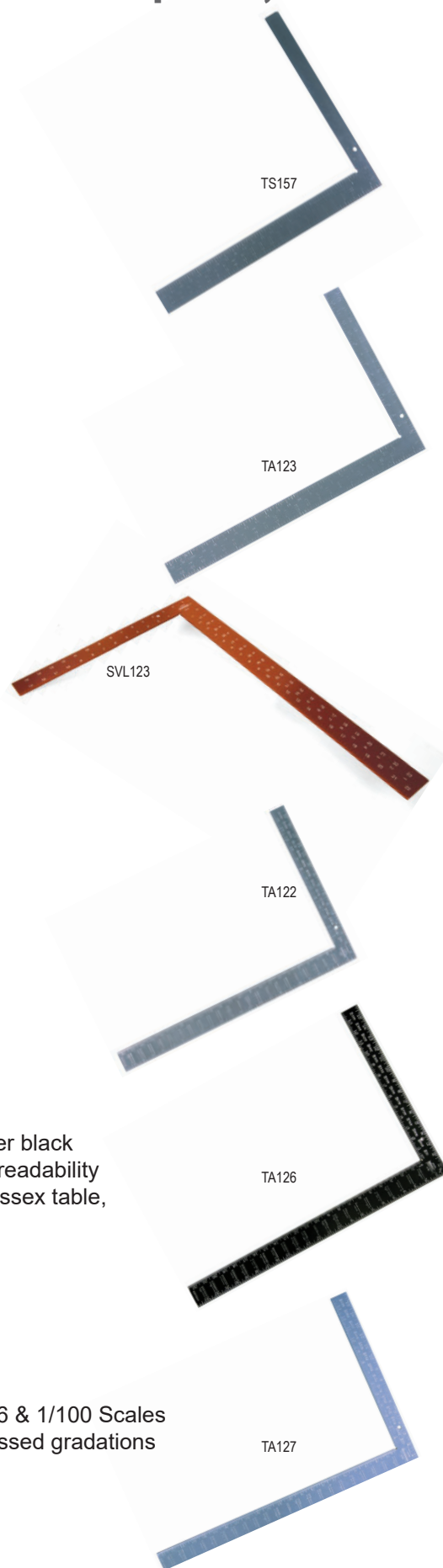

Builder Squares

Steel Rafter, Utility, Try & Miter, Sliding T-Bevel



Steel Rafter Square

- High-grade tempered steel with "Hi-Vis" yellow coated finish
- 1/8, 1/10, 1/12, 1/16, & 1/100 Scales
- Reverse-reading scale
- Black thermo-bounded gradations
- Rafter, brace & essex tables; octagon scales

MFR #	Length	Color	Std Pk	Control #
TS154	16" x 24"	Hi-Vis Yellow	6	

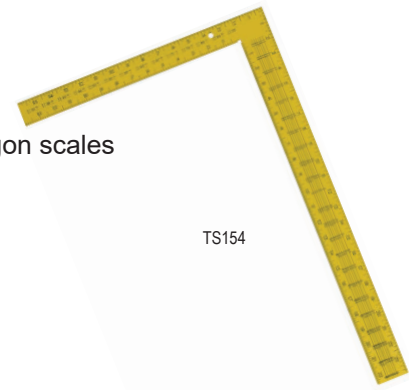

TS154

Utility Square

- High-grade steel
- Nickel Plated, resists rust
- Face gradations in 8ths & 12ths
- Back gradations in 8ths & 16ths
- Acid wash for anti-glare matte finish
- Permanently impressed gradations

MFR #	Length	Color	Std Pk	Control #
TS153	8" x 12"	Steel	12	1520823

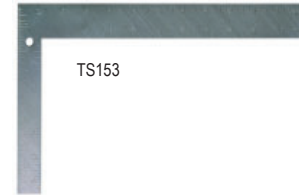

TS153

Try & Miter Square

- 1/16 in. & 1/8 in. gradations
- High impact molded handle with vial
- Etched stainless steel blade, 1/8 in. & 1/16 in. gradations
- 45° angle in handle for easy layout
- Available with brass bound hardwood handle (TS152)

MFR #	Length	Color	Std Pk	Control #
TS151	8"	Black Plastic & Steel	6	
TS152	8"	Wood, Brass & Steel	6	



TS151

Try Square

- Aerospace Aluminum anodized frame with rubber coated handle insert
- Retractable Kickstand™ helps hold materials
- Stainless steel etched blade
- Blade scribe bar

MFR #	Length	Color	Std Pk	Control #
SVR149	9"	Stainless Steel & Orange	6	



SVR149



Sliding T-Bevel

- All brass hardware
- Hardwood handle
- Etched stainless steel 9 in. blade
- Brass bound ends

MFR #	Length	Color	Std Pk	Control #
TS149	9"	Brass & Wood	6	



TS149

T-Bevel with Metal Knob

- Bottom located tightening bolt
- Stainless steel chemically etched blade
- Aerospace aluminum anodized frame with rubber coated handle insert

MFR #	Length	Color	Std Pk	Control #
SVV150	9"	Stainless Steel & Orange	6	



SVV150



Sliding T-Bevel with Level Vial

- Level vial in handle for easy referencing
- Heavy-duty composite handle
- Etched stainless steel 8 in. blade

MFR #	Length	Color	Std Pk	Control #
TS150	8"	Black Plastic & Steel	6	



TS150



Wallboard Squares

Drywall, Wallboard

Drywall Square

- Durable alluminum alloy frame is 1/8" thick
- Body is standard outlet size for easy marking
- Five rivets and two steel roll pins accurately secure head and body
- Black thermobonded gradations over a hi-viz yellow for easy reading
- Resists nicks from utility knives

MFR #	Length	Color	Std Pk	Control #
TDT148	48"	Yellow	2	



TDT148

Adjustable Aluminum Drywall Square

- Full adjustable head allows multiple angle cuts
- Collapses fully, easier storage and portability
- Thermo-bonded gradations
- Resists nicks from utility knives

MFR #	Length	Color	Std Pk	Control #
AD124	48"	Aluminum	3	



AD124

Aluminum T-Square Wallboard Square

- Resists nicks from utility knives
- Body is standard outlet size for easy marking
- Five rivets and two steel roll pins accurately secure head and body

MFR #	Length	Color	Std Pk	Control #
TD124	48"	Yellow	2	
TD540	54"	Yellow	2	

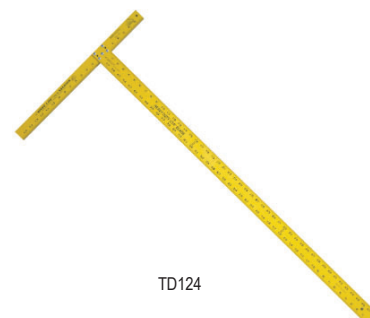

TD124

Wallboard Square

- 5 Stainless steel rivots
- Body is 3/16" thick
- Precision laser etching
- Anodized aerospace aluminum

MFR #	Length	Color	Std Pk	Control #
SVW124	48"	Orange	2	



SVW124



Straight Edges

Cutting Guide



Straight Edges

- High-grade aluminum alloy
- Thermally fused yellow powder paint finish
- Lightweight and strong
- Non-glare finish
- Black thermo-bonded gradations

MFR #	Length	Width	Std Pk	Control #
AE141	36"	1-1/4"	10	
AE142	48"	2"	3	
AE143	60"	2"	3	
AE144	72"	2"	3	



AE141

Aluminum Cutting Guide

- Includes two 50" cutting guides; joining bar allows expansion to 100"
- Low-profile design guides any saw, router, or utility knife
- Made of durable, high-grade anodized aluminum
- Includes C-clamps
- Break-down design makes for easy storage

MFR #	Length	Std Pk	Control #
CG100	100"	6	



CG100

No Slip Straight Edges

- No Slip Grip backing
- Thumb Saver raised edge
- Anodized aerospace aluminum
- Precision laser etching

MFR #	Length	Std Pk	Control #
SVE240	24"	3	
SVE360	36"	3	
SVE480	48"	3	
SVE720	72"	1	
* SVE960	96"	1	

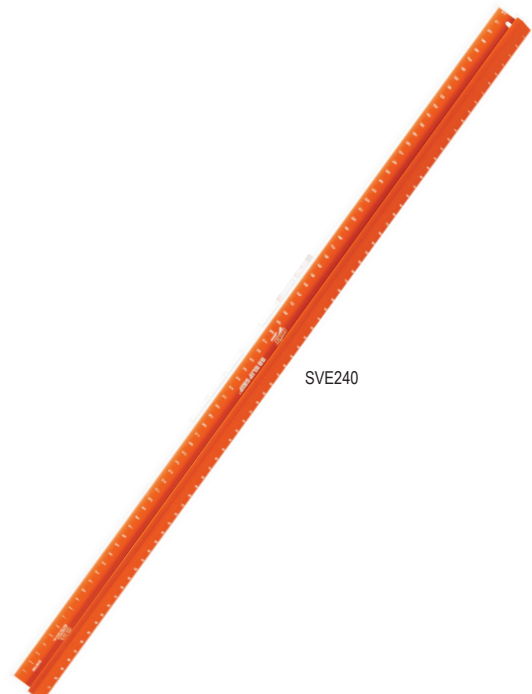

SVE240



* FOB - Houston GFL Dock Only Due to Overlength



Professional Series Measuring Tapes

Magnetic Proscribe™ 25ft. Tape Measure

- Scribes circles into surfaces with centering pin
- Scribe guide eliminates slivers
- 1 in. wide blade with large number display on top and bottom for easy readability
- Magnetic tip
- 8 ft. standout

MFR #	Std Pk	Control #
SVPS25M1	6	1520811



SVPS25M1

SAVAGE

Proscribe™ 8 Meter Tape Measure

- Scribes circles into surfaces with centering pin
- Scribe guide eliminates slivers
- 1 in. wide blade with large number display on top and bottom for easy readability

MFR #	Std Pk	Control #
SVPS8M1M	6	



SVPS8M1M

SAVAGE

Magnetic Gripline™ 25ft. Tape Measure

- Grips PVC, conduit and pipe up to 2 in. in diameter
- Grips vertical & rounded edges with rotating tip
- 1 1/16 in. wide blade with large number display on top and bottom for easy readability
- Magnetic tip
- 8 1/2 ft. standout

MFR #	Std Pk	Control #
SVGL25M1	6	1520812



SVGL25M1

SAVAGE

Gripline™ 8 Meter Tape Measure

- Grips PVC, conduit and pipe up to 2 in. in diameter
- Grips vertical & rounded edges with rotating tip
- 1 1/16 in. wide blade with large number display on top and bottom for easy readability

MFR #	Std Pk	Control #
SVGL8M1M	6	



SVGL8M1M

SAVAGE

Compact Measuring Wheel

- Telescoping handle extends to 36" for comfortable handling
- Easy-to-read magnified counter features large numbers on high-contrast, black and white display
- Button feature easily resets counter to 0
- Handle collapses to 20" for easy portability and storage
- Counter displays feet and inches in separate formats for easy differentiation between units
- Available in Metric model (SWRT3940M)

MFR #	Std Pk	Control #
SWRT3940	1	
SWRT3940M	1	



SWRT3940

Accessories

Carpenter Pencil, Refills, Holder & Saw



Always Sharp® Refillable Carpenter Pencil

- Pack features refillable graphite that eliminates sharpening
- Pencil lasts 5 times longer than a traditional Carpenter Pencil
- Each pencil comes with a cap to protect against damage during storage
- 3/8" Graphite tips are sharp on both sides
- Pack includes 2 pencils & 8 refills



MFR #	Length	Color	Std Pk	Control #
CP216	7.88"	Gray	1	

Always Sharp® Replacement Tips

- 24 replacement tips

MFR #	Color	Std Pk	Control #
CPLBLK	Black	10	
CPLRED	Red	10	



CPLBLK



SDP217

Speed Draw Pencil Holder

- Fits most carpenter pencils & markers
- Comfort rubber grip
- Super strong magnets

MFR #	Length	Color	Std Pk	Control #
SDP217	7"	Orange	12	1520825

Carpenter Pencils - 5 Pack & 72 Box

- High visibility orange paint finish
- Ideal for all woodworking and remodeling projects
- Stays put - won't roll
- CP700 (5 pack carded) | CP700B (72 bulk box)

MFR #	Length	Color	Std Pk	Control #
CP700	7"	Orange	10	
CP700B	7"	Orange	1 Box of 72	



CP700
(carded)



CP700B
(bulk box)

Folding Saw with 3 piece Saw Blade

- 2 cutting positions
- Works with any reciprocating saw blade
- Integrated utility knife
- Convenient belt case
- Folding saw by itself (SVK667)

MFR #	Std Pk	Control #
SVK666	2	
SVK667	6	



SVK666





Accessories

Plumb Bobs, Stair Gauges, Butt Marker, Instruction Manual

Brass Plumb Bob

- Solid brass
- Removable top to center string
- Hardened steel tip

MFR #	Weight	Std Pk	Control #
PB008B	8 oz.	5	
PB016B	16 oz.	5	



PB008B

Steel Plumb Bob

- Removable head
- Plated Steel
- Resists rusts

MFR #	Weight	Std Pk	Control #
PB008S	8 oz.	5	



PB008S

Solid Brass Stair Gauges

- Precision accuracy
- For stairway construction
- Use to layout repetitive cuts
- Solid Brass construction

MFR #	Std Pk	Control #
SG0020	6	



SG0020

Little "Blue Book" of Instructions for Roof & Stairway Layout

- 60 page manual
- "One Number Method"SM for roof layout
- Includes rafter tables & construction diagrams

MFR #	Std Pk	Control #
P0110	5	

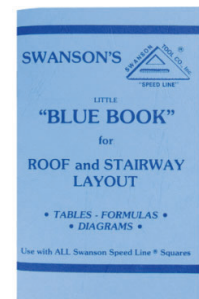

P0110

Hinge Butt Marker

- High-grade die cast aluminum alloy

MFR #	Size	Std Pk	Control #
S0106	4"	5	



S0106