

# PRODUCT CATALOG

- ✓ Manual Chain Hoists
- ✓ Lever Hoists
- ✓ Beam Clamps
- ✓ Push Trolleys
- ✓ Wire Rope Pullers
- ✓ Shipyard Hooks
- ✓ Lever & Chain Hoist Parts

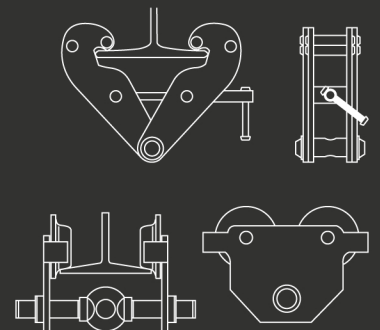

## MANUAL CHAIN HOISTS

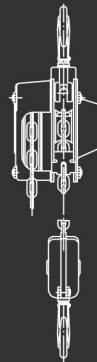
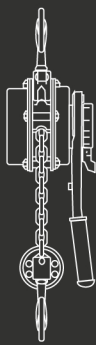
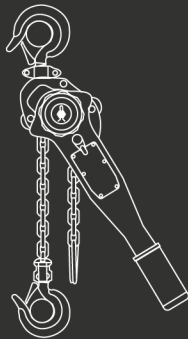
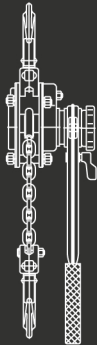

**AVAILABLE WITH  
OVERLOAD PROTECTION!**

### GR. 80 LOAD CHAIN - AUTO BRAKE - BOLT ON LATCHES - HEAT TREATED HOOKS

Hoist #	Tonnage Rating	Lift	Capacity Lbs	Load Chain	Hand Chain Galv.	Weight Lbs/ea
VCH12X	1/2	-	1,000	6x18	5x25	13
VCH12X10	1/2	10	1,000	6x18	5x25	24
VCH12X15	1/2	15	1,000	6x18	5x25	29
VCH12X20	1/2	20	1,000	6x18	5x25	35
VCH1X	1	-	2,000	6x18	5x25	17
VCH1X10	1	10	2,000	6x18	5x25	28
VCH1X15	1	15	2,000	6x18	5x25	34
VCH1X20	1	20	2,000	6x18	5x25	42
VCH1X30	1	30	2,000	6x18	5x25	50
VCH112X	1-1/2	-	3,000	8x24	5x25	22
VCH112X10	1-1/2	10	3,000	8x24	5x25	40
VCH112X15	1-1/2	15	3,000	8x24	5x25	46
VCH112X20	1-1/2	20	3,000	8x24	5x25	56
VCH112X30	1-1/2	30	3,000	8x24	5x25	65
VCH2X	2	-	4,000	8x24	5x25	28
VCH2X10	2	10	4,000	8x24	5x25	44
VCH2X15	2	15	4,000	8x24	5x25	51
VCH2X20	2	20	4,000	8x24	5x25	59
VCH2X30	2	30	4,000	8x24	5x25	74
VCH3X	3	-	6,000	8x24	5x25	35
VCH3X10	3	10	6,000	8x24	5x25	59
VCH3X15	3	15	6,000	8x24	5x25	71
VCH3X20	3	20	6,000	8x24	5x25	83
VCH3X30	3	30	6,000	8x24	5x25	98
VCH5X	5	-	10,000	10x30	5x25	62
VCH5X10	5	10	10,000	10x30	5x25	100
VCH5X15	5	15	10,000	10x30	5x25	117
VCH5X20	5	20	10,000	10x30	5x25	135
VCH5X30	5	30	10,000	10x30	5x25	166
VCH10X10	10	10	20,000	10x30	5x25	183
VCH10X15	10	15	20,000	10x30	5x25	214
VCH10X20	10	20	20,000	10x30	5x25	246
VCH20X15	20	15	40,000	10x30	5x25	489
VCH20X20	20	20	40,000	10x30	5x25	509

REPLACEMENT PARTS AVAILABLE  
CHAIN AVAILABLE BY THE FOOT

**VGD HOISTS**

### WARNINGS:

- NEVER EXCEED WORKING LOAD LIMITS
- INSPECT ALL COMPONENTS FREQUENTLY FOR SIGNS OF WEAR OR DAMAGE!
- KEEP LOAD CHAINS LUBRICATED!

**LEVER HOISTS**

**1/2 - 3 TON**



**1/4 TON**

**6 - 9 TON**

**GR. 80 LOAD CHAIN - AUTO BRAKE - BOLT ON LATCHES - HEAT TREATED HOOKS**

Hoist #	Tonnage Rating	Lift	Capacity Lbs	Load Chain	Weight Lbs/ea
VLH14X5	1/4	5	500	4x12	5.5
VLH14X10	1/4	10	500	4x12	6.5
VLH12X5	1/2	5	1,000	5x15	10
VLH12X10	1/2	10	1,000	5x15	12
VLH34X	3/4	w/o	1,500	6x18	13
VLH34X5	3/4	5	1,500	6x18	16
VLH34X10	3/4	10	1,500	6x18	19
VLH34X15	3/4	15	1,500	6x18	22
VLH34X20	3/4	20	1,500	6x18	24
VLH112X	1-1/2	w/o	3,000	8x24	20
VLH112X5	1-1/2	5	3,000	8x24	28
VLH112X10	1-1/2	10	3,000	8x24	32
VLH112X15	1-1/2	15	3,000	8x24	37
VLH112X20	1-1/2	20	3,000	8x24	42
VLH3X	3	w/o	6,000	10x30	38
VLH3X5	3	5	6,000	10x30	46
VLH3X10	3	10	6,000	10x30	54
VLH3X15	3	15	6,000	10x30	61
VLH3X20	3	20	6,000	10x30	69
VLH6X	6	w/o	12,000	10x30	51
VLH6X5	6	5	12,000	10x30	73
VLH6X10	6	10	12,000	10x30	86
VLH6X15	6	15	12,000	10x30	99
VLH6X20	6	20	12,000	10x30	114
VLH9X	9	w/o	18,000	10x30	82
VLH9X5	9	5	18,000	10x30	104
VLH9X10	9	10	18,000	10x30	125
VLH9X15	9	15	18,000	10x30	147
VLH9X20	9	20	18,000	10x30	168

REPLACEMENT PARTS AVAILABLE  
CHAIN AVAILABLE BY THE FOOT



**WARNINGS:**

- NEVER EXCEED WORKING LOAD LIMITS
- INSPECT ALL COMPONENTS FREQUENTLY FOR SIGNS OF WEAR OR DAMAGE!

# MANUAL CHAIN HOISTS



**AVAILABLE WITH  
OVERLOAD  
PROTECTION  
(OPTIONAL)**

### Special Features

- **Light weight robust construction.** Automatic double pawl braking system - Heavy duty friction discs
- **Forged hooks w/ latches.** Alloy load chain - Zinc plated hand chain
- **Low manual effort required to lift maximum load**
- **Each hoist proof tested at 1.5 times WLL (Working Load Limit)**

# VLH LEVER HOISTS

### Special Features

- **Compact Design.** Automatic braking engagement holding load at any desired height
- **Optimal gear ratio.** Load chain can be pulled through the hoist when in neutral position for quick take up.
- **Drop forged steel construction.** Forged alloy hooks w/ latches - Alloy steel load chain



Hoist #	Capacity in Tons		Proof Load Lbs	Effort Lbs	# of Falls, Load Chain	Load Chain mm
	Metric	US				
VCH12X	0.5	0.55	1,653	51.93	1	6x18
VCH1X	1	1.10	3,307	69.46	1	6x18
VCH112X	1.5	1.65	4,960	71.94	1	8x24
VCH2X	2	2.20	6,614	80.93	1	8x24
VCH3X	3	3.31	9,921	76.43	2	8x24
VCH5X	5	5.51	16,534	93.07	2	10x30
VCH10X	10	11.02	33,069	93.07	4	10x30
VCH20X	20	22.05	55,115	93.07 x 2	8	10x30

Hoist #	Dimensions mm/in				
	A	B	C	D	K
VCH12X	131/5.16	127/5.00	270/10.63	35/1.38	30/1.18
VCH1X	140/5.51	158/6.22	317/12.48	35.5/1.40	30/1.18
VCH112X	161/6.34	174/6.85	399/15.71	45/1.77	36/1.42
VCH2X	161/6.34	187/7.36	414/16.30	47/1.85	36/1.42
VCH3X	161/6.34	199/7.83	465/18.31	50/1.97	40/1.57
VCH5X	186/7.32	253/9.96	636/25.06	64/2.52	50/1.97
VCH10X	207/8.15	398/15.67	798/31.42	85/3.35	64/2.52
VCH20X	215/8.46	650/25.59	890/35.04	110/4.33	85/3.35

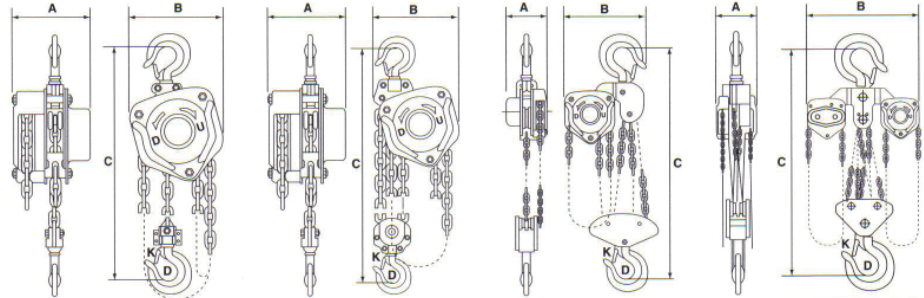

**1/2T, 1T, 2T**

**3T, 5T**

**10T**

**20T**

Hoist #	Capacity in Tons		Proof Load Lbs	Effort Lbs	# of Falls, Load Chain	Load Chain mm
	Metric	US				
VLH14X	0.25	0.27	815	30.68	1	4X12
VLH12X	0.5	0.55	1,653	26.97	1	5x15
VLH34X	0.75	0.83	2,480	31.47	1	6x18
VLH112X	1.5	1.65	4,960	49.45	1	8x24
VLH3X	3	3.31	9,921	71.93	1	10x30
VLH6X	6	6.61	19,841	76.43	2	10x30
VLH9X	9	9.92	29,762	80.93	3	10x30

Hoist #	Dimensions mm/in						
	A	B	C	D	H	L	K
VLH14X	92/3.62	71/2.79	70/2.75	31/1.22	245/9.64	168/6.61	19/0.74
VLH12X	105/4.13	75/2.95	80/3.14	35/1.37	260/10.23	300/11.81	24/0.94
VLH34X	145/5.71	86/3.38	122/4.80	40/1.57	320/12.59	280/11.02	26/1.02
VLH112X	175/6.88	100/3.93	130/5.11	45/1.77	380/14.96	410/16.14	30/1.18
VLH3X	203/7.99	118/4.64	150/5.90	55/2.16	480/18.89	410/16.14	38/1.49
VLH6X	203/7.99	118/4.64	205/8.07	65/2.55	620/24.40	410/16.14	50/1.96
VLH9X	203/7.99	118/4.64	316/12.44	85/3.34	700/27.55	410/16.14	64/2.51

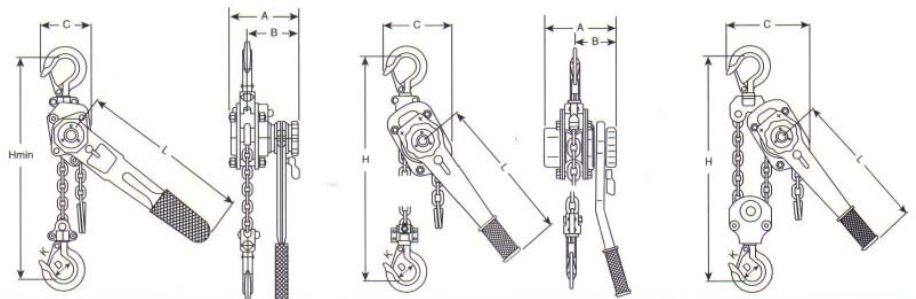

**1/4T & 1/2T**

**3/4T, 1-1/2T, 3T**

**6T, 9T**

## BEAM CLAMPS



**VGD** ADJUSTABLE

BEAM CLAMPS ARE DESIGNED TO ATTACH TO OVERHEAD I-BEAMS, EASY ANCHOR POINTS FOR CHAIN AND LEVER HOISTS ONLY. DO NOT USE FOR LIFTING OR PULLING.

Clamp #	Capacity in Tons		Proof Load Lbs	Load Chain Lbs
	Metric	US		
VBC1	1	1.10	3,307	10
VBC2	2	2.20	6,614	11
VCB3	3	3.31	9,921	23
VBC5	5	5.51	16,534	24
VBC10	10	11.02	33,069	35

Clamp #	Flange Width	Dimensions - Inches							
		A (max)	B (min/max)	C	D	E (min)	F (min/max)	G	H
VBC1	2.95-8.66	10.24	7.09-14.17	2.52	.20	8.46	4.02-6.10	0.98	0.87
VBC2	2.95-8.66	10.24	7.09-14.17	2.91	.24	8.46	4.02-6.10	0.98	0.87
VCB3	3.15-12.60	13.94	9.25-19.29	4.06	.315	10.24	5.51-8.86	1.77	0.94
VBC5	3.15-12.60	13.94	9.25-19.29	4.33	.39	10.24	5.51-8.86	1.77	1.10
VBC10	3.15-13.78	15.75	9.84-20.47	4.72	.472	10.24	5.51-8.86	2.76	1.73

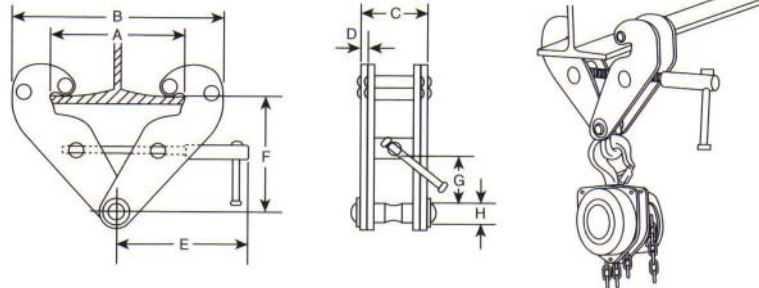

## PUSH TROLLEY



Trolley #	Capacity in Tons		Approx. Weight Lbs	Width Inches	Dimensions - Inches			
	Metric	US			A	B	C	H
VPT12	1/2	0.55	11	1.96-8.66	11.22	7.80	6.22	2.54
VPT1	1	1.10	19	1.96-8.66	11.22	9.37	7.20	2.60
VPT2	2	2.20	31	2.60-8.66	11.81	10.90	8.19	2.95
VPT3	3	3.31	52	2.91-8.66	12.64	12.75	9.80	3.35
VPT5	5	5.51	88	3.54-8.66	13.94	14.69	11.67	3.94
VPT10	10	11.02	195	4.92-7.99	15.87	17.91	19.29	10.85

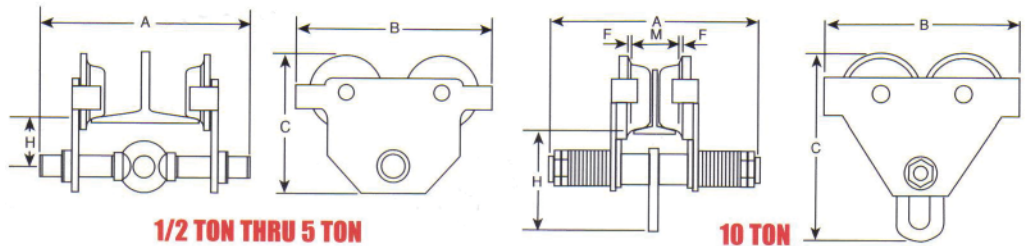

- WARNINGS:**
- IMPROPER USE OR OVERLOADING MAY RESULT IN SERIOUS INJURY AND/OR DEATH!
  - THE INSTALLATION OF BEAM CLAMPS MUST ALWAYS BE PERFORMED BY QUALIFIED RIGGERS ONLY WHO ARE FULLY FAMILIAR WITH ALL APPLICABLE STANDARDS (OSHA, ASME B30.16-2007)



**LIFTING** LLC

### **VGD** WIRE ROPE PULLERS

Cable pullers are very versatile tools which are commonly used on construction sites, for laying of large pipes, installation and adjustments of machines, loading and unloading heavy and bulky goods, tensioning cables, tower erecting, stacking of forest products and the removal of obstacles.

- Compact, light weight units
- Extendable operating lever included with all units
- Low maintenance requirements
- Units are supplied without cable assembly
- Aluminum-alloy housing
- Heavy duty design, ensures a long and reliable service life
- Designed to operated in any position to lift, pull or lower materials
- The front and back clamping system provide a large surface contact area which evenly distributes the cable grip reducing cable wear while maximizing user safety
- The rope clamping system can be disengaged which offers smooth and easy installation of the cable assemblies
- Auto adjust device as a standard
- Standard overload protection for increased operator safety
- Specially built in shear pins can be replaced without removing the load



Model No.	Lifting Capacity Lbs	Pulling Capacity Lbs	Rope advance per full stroke (Inches)	Lever pull at WLL Lbs	Weight (without cable) Lbs
VGD 8A	1,760	2,750	2.36	55	15.5
VGD 16A	3,520	5,500	2.36	66	31
VGD 32A	7,040	11,000	1.57	110	51

### **VGD** SHIPYARD HOOKS

Model	Description
VLHBH34SY	Shipyards bottom hook for 3/4 Ton Lever Hoist
VLHBH112SY	Shipyards bottom hook for 1-1/2 Ton Lever Hoist
VLHTH34SY	Shipyards top hook for 3/4 Ton Lever Hoist
VLHTH112SY	Shipyards top hook for 1-1/2 Ton Lever Hoist



SHIPYARD TOP HOOK



SHIPYARD BOTTOM HOOK

\* Custom lengths available upon request

### **WARNINGS:**

- **ROPE PULLERS MUST ONLY BE USED BY PROPERLY TRAINED PERSONS**
- **INSPECT ALL COMPONENTS FREQUENTLY FOR SIGNS OF WEAR OR DAMAGE!**
- **NEVER EXCEED WORKING LOAD LIMITS**
- **NEVER USE TO PULL OR LIFT PEOPLE (NO "MAN-RIDING")**

## WARNINGS:

Prior to the installation and use of Hoists, Beam Clamps and Trolleys you must assure that the supporting structure provides the required safety factor, taking the intended load plus the weight of all devices into account. This may require the consultation of a qualified structural engineer.

None of the devices featured in the preceding pages must be used for LIFTING, TRANSPORTING or SUPPORTING of PEOPLE or the TRANSPORTATION OF LOADS over people!

**The Installation and operation must only be performed by qualified persons** who are fully familiar with all operating and maintenance procedures, warnings and cautions.

## WARRANTY:

**R&D LIFTING LLC** makes every effort to assure that all its products are manufactured to the highest standards for their designed purpose and warrants them for the period of 1 year after delivery to be free from defects in material and workmanship.

As long as products have been used in accordance with the manufacturer's recommendations and Industry guidelines and have not been subjected to misuse, abuse, negligence, lack of maintenance and/or unauthorized repair or alterations, R&D, at its discretion, will repair or replace a product free of charge within the warranty period. Any returns under this provision must be pre-authorized by R&D and sent to R&D on a freight prepaid basis. In cases where the defect does not fall within the scope of this warranty or where no defect can be established, the product will be returned freight collect.

**R&D** disclaims any and all warranties other than those expressed above, nor will it be liable for death, injury to persons or property, or any costs arising in connection with the use or inability of use, or any failure of action by R&D.

## OTHER RIGGING PRODUCTS (direct mill shipments only):



**Wire Ropes, Cables & Strand**

**Wire Rope Hardware**

**Chain & Accessories**

**Note:**



**also offer Private Branding for its products**  
(subject to minimum quantity requirements)



All **VGD** Hoist Products have a one year warranty against manufacturing defects, subject to inspection.



**ACORD, CERTIFICATE OF LIABILITY INSURANCE**

INSURED: R&D LIFTING, INC.  
 1700 W. GORHAM ST.  
 TAMPA, FL 33607  
 P.O. BOX 89249  
 TAMPA, FL 33689

AGENCY: [REDACTED]

CLASSIFICATION: [REDACTED]

TERMS: [REDACTED]

COVERAGE: [REDACTED]

AMOUNTS: [REDACTED]

EXCLUSIONS: [REDACTED]

ENDORSEMENTS: [REDACTED]

DATE: [REDACTED]

TIME: [REDACTED]

AGENT: [REDACTED]

**R&D LIFTING**

P.O. Box 89249 Tampa, FL 33689  
 Tel: 813-248-0501  
 Fax: 813-248-0507  
 Email: sales@rdlifting.com

Item	Description	Qty	Unit Price	Total Price
1.00	10000	1	10000.00	10000.00
2.00	20000	1	20000.00	20000.00
3.00	30000	1	30000.00	30000.00
4.00	40000	1	40000.00	40000.00
5.00	50000	1	50000.00	50000.00
6.00	60000	1	60000.00	60000.00
7.00	70000	1	70000.00	70000.00
8.00	80000	1	80000.00	80000.00
9.00	90000	1	90000.00	90000.00
10.00	100000	1	100000.00	100000.00

**PROOF TEST**

Pressure Force



**P.O. Box 89249 Tampa, FL 33689**

**Tel. 813-248-0501**

**Fax 813-248-0507**

**Toll free 888-740-0515**

**Email: sales@rdlifting.com**