

# Tactical Behaviour Disruptor

TBD: Your Study Buddy

Build18 2025-26: The Antisocial Artificers

# The Antisocial Artificers (pronounced "AAAH")



Aryaa Rojekar

ECE + Robotics



Kashvi Verma

ECE + AI



Cindy Sun

ECE + AI



Noella Horo

CS + ML and  
Robotics



Jessica Wang

CS + HCI



# Certified Procrastination Specialists





“Based on data from **124 experiments across 32 studies**, participants **exposed to attentional interference** demonstrated **significantly lower reading comprehension** scores than those who were not exposed to attentional interference.”

□ Shen, Yamin. (2025). Distractions in digital reading: a meta-analysis of attentional interference effects. *Frontiers in Psychology*. 16. 10.3389/fpsyg.2025.1671214.



# TBD is an innovative antidote to distraction.

Easy to assemble design

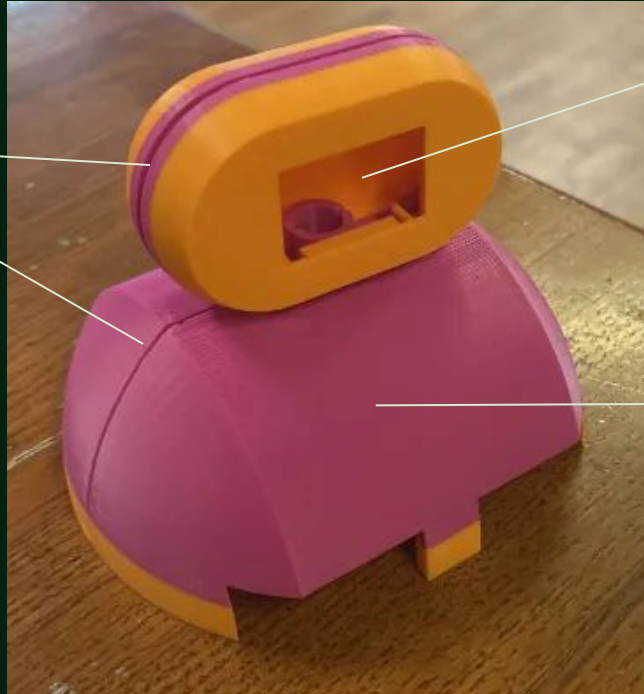

LED screen displays a range of emotions

Body with full range of motion



# TBD encourages productivity by emulating social behaviors and gives the user a sense of responsibility.

## Loss of Concentration

Robot detects that the user is not focused .

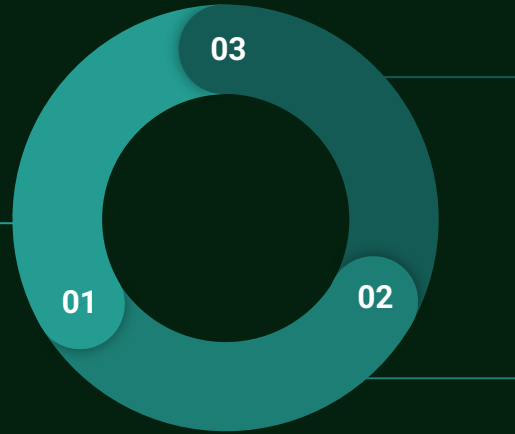

## User Refocuses

User responds to the robot's cues and refocuses on their task.

## Robot Discourages User

Robot mimics social behaviors of discouragement through its movement and LED expressions.



“It’s a squishy little guy that gets mad at you when you get distracted” – Aryaa

# Existing Market in Software Solutions

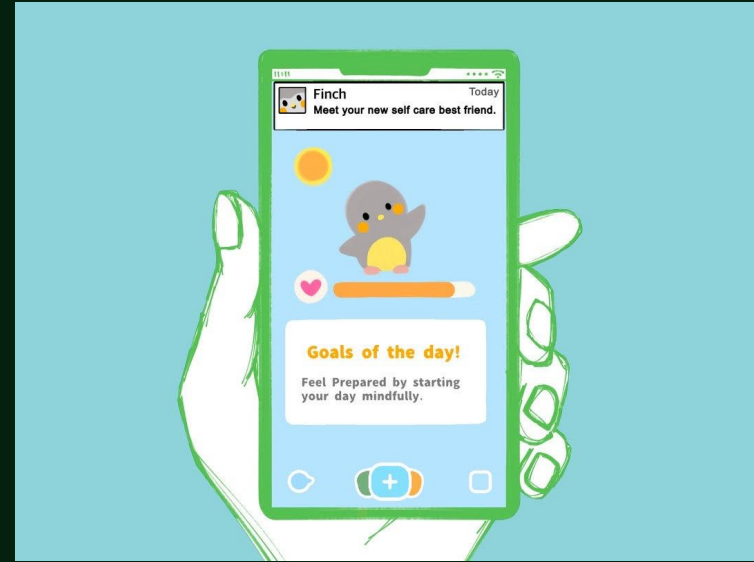

But what do all these apps have in common?

They run on your phone!

|                      | Budget-Friendly | Lightweight | Suitable |
|----------------------|-----------------|-------------|----------|
| 1 TBD (Our Solution) | ✓               | ✓           | ✓        |
| 2 Ebo X              | ✗               | ✗           | ✓        |
| 3 EMO                | ✗               | ✓           | ✗        |





In terms of competition, we have no competition

# DS SOLIDWORKS

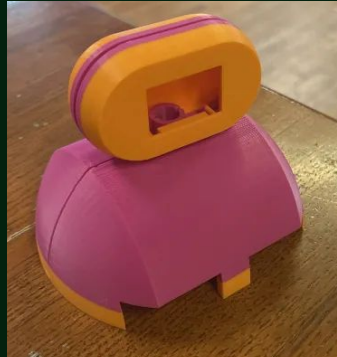
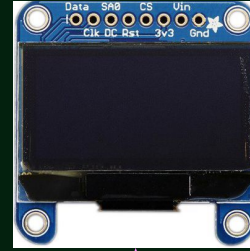
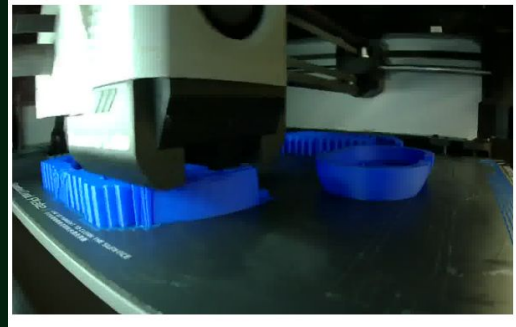
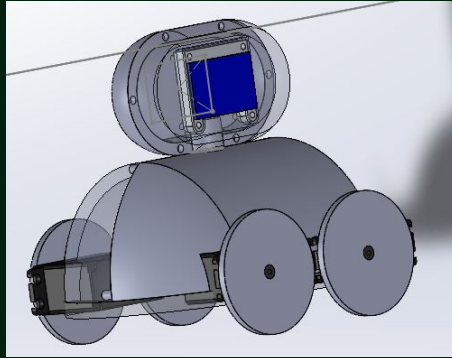

Noella 8:00 PM  
so baby 🥺

Aryaa Yesterday at 9:59 PM  
so smol...

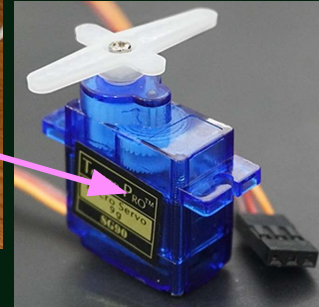

Process flow

## Pi Side

## Remote Server

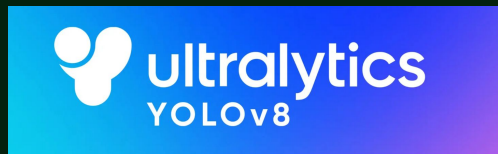

Vision model

kaggle

Cell phone dataset



Django backend

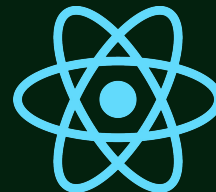

React frontend



Face detector +  
Phone detector

+



Flask

Pomodoro timer

+

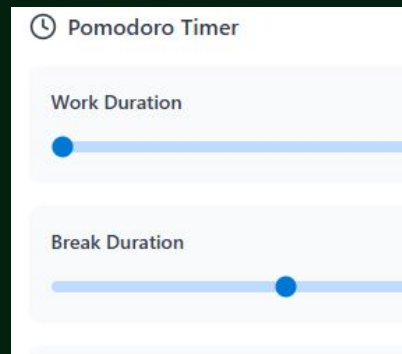

/api/settings

Is working?

# Marketing Strategy

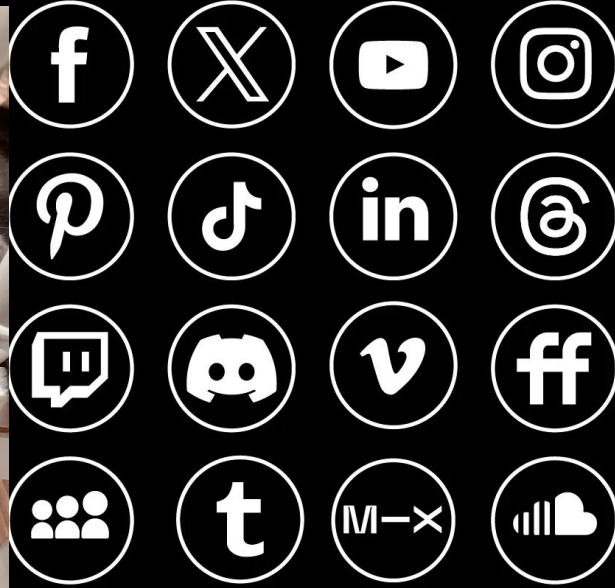
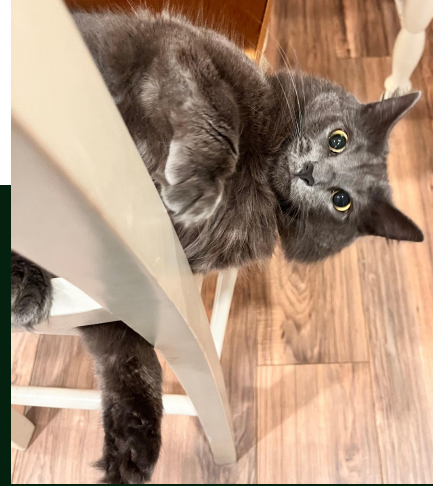
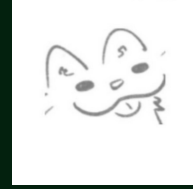



## Make it customizable!

- Different models include shrimp and buggy
- Custom mobility and expression features

## Make it portable!

Independent power source

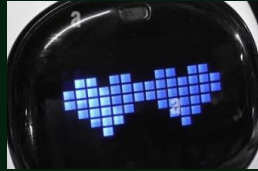

## Integrate speech recognition

Add microphone for voice commands



## Improve distraction detection algorithms

Pose, body language, other elements

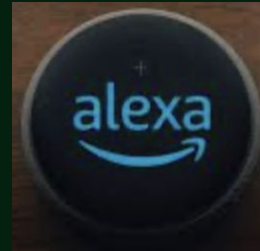

**Aryaa** Yesterday at 7:05 PM  
YALL FREE PARTS

**Kash675** Yesterday at 7:36 PM  
Bruh

**cindy** 2:47 PM  
Girl are you talking in inscription

**Noella** 9:00 PM  
what a good little bot 🥺

**Cindy** 10:58 PM  
im crashing out  
the screen is NOT WORKING?!

**Aryaa** 10:59 PM  
l2c hates us

**Jessica** 5:50 PM  
Amazing

**Kash675** Yesterday at 7:53 PM  
Where?  
Boba where?



 **Kash675** 1/13/26, 10:41 AM  
I'm awake

 **Aryaa** 1/13/26, 10:41 AM  
Hi

 **cindy** 1/13/26, 10:41 AM  
Morning  
I'll start heading over

 **Kash675** 1/13/26, 10:41 AM  
Wait wait wait  
I'm awake does not mean I'm leaving

 **Kash675** 1/13/26, 7:33 PM  
There is no demo  
It doesn't work  
Nothing works  
Help