



LED Technology

Unrivalled lifespan of up to 100,000 hours together with low power consumption and resistance to high levels of shock and vibration make LEDs the ideal light source for emergency lighting. Their compact size allows them to be used in a wide range of applications from surface mount flashing lamps to rotating beacons.



Magnetic Bases

Magnetic based beacons are available in four speed ratings.

Maximum safe road speed is indicated in each relevant product table.

For beacons to mount successfully they must be attached to a clean, flat, dry, non porous, ferrous surface.

MAX
80
KM/H



MAX
100
KM/H



MAX
110
KM/H



MAX
112
KM/H



Lighting Symbols



Rotating LED
LED light source
with rotating
reflector



LED



Rotating Halogen
Halogen bulb light
source with rotating
reflector



Strobe
Xenon tube



Beacons

IONNIC 103 LED	16
IONNIC 103 LED – Dual Colour	17
IONNIC 106 LED	18
Rotating LED	20
IONNIC 105 LED	22
IONNIC 101 LED	24
IONNIC 111 LED	25
Midi Vision	26
500 Series	28
Heavy Duty Xenon	30
Midi Xenon	31
Mini Vision	32
IONNIC Mini Xenon	33
Beacon Accessories	36

Beacons

IONNIC 103 LED

NEW



103010

12V 24V IP67 5Yrs

- SAE class 1 rated output.
- 12 flash patterns.
- Vibration resistance rated to SAE J575.
- Polycarbonate lens for high durability.
- Low current draw.
- 103 & 106 beacons can be synchronised.
- Multi-voltage.
- Environmentally sealed – IP67.
- Aerodynamic low profile.
- Magnetic version features cigar plug with integrated on/off & pattern select switches.
- 5 year warranty.

Voltage : 12–24V
Current Draw : 3.2A @ 12V
Flash Patterns : 12
Lens : Polycarbonate
Base : Aluminium
Approvals : ECE R10, ECE R65 (Amber & Blue)
 SAE J845 Class1 (Amber)
Ingress Protection : IP67
Operating Temperature : -30°C to 50°C
Light Source : 18 x 3W LED

On/off and pattern select



103000 illuminated



Clear lens with coloured LED illumination



IONNIC 103 LED – 3 Bolt NEW

	Amber	Blue	Green	Red
Coloured Lens	103000	—	—	—
Clear Lens	103000C	103200C	103300C	103400C

Supplied with 3 x M6 bolts, nuts, shake-proof washers & base gasket.
 Mounting: 3 x Ø 7mm holes @ 151 PCD.
 230mm free length of cable.

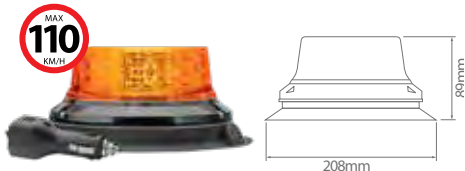

IONNIC 103 LED – Magnetic NEW

Coloured Lens	103010
---------------	---------------

3.5m lead to cigar plug with on/off and pattern select switches.

NEW

- Can be used in 3 modes:
 - Colour 1
 - Colour 2
 - Dual colour mode.
- 12 flash patterns in single colour mode, 5 flash patterns in dual colour mode.
- Vibration resistance rated to SAE J575.
- Polycarbonate lens for high durability.
- Low current draw.
- 103 & 106 beacons can be synchronised.
- Multi-voltage.
- Environmentally sealed - IP67.
- Aerodynamic low profile.
- 5 year warranty.



Voltage :	12-24V
Current Draw :	3.2A @ 12V
Flash Patterns :	12
Lens :	Polycarbonate
Base :	Aluminium
Approvals :	ECE R10
Ingress Protection :	IP67
Operating Temperature :	-30°C to 50°C
Light Source :	18 x 3W LED

- 12V 24V
- ECE R10
- IP67
- 5Yrs

Colour Modes

Dual Colour beacons contain dual colour chip LEDs. Each colour is controlled independently, so the beacon can function as one OR the other colour, with 12 flash patterns to choose from. Dual Colour Mode is restricted to 5 flash patterns.



Colour 1 Mode
12 Flash Patterns



Colour 2 Mode
12 Flash Patterns



Dual Colour Mode
5 Flash Patterns

Vacuum Magnetic Mount Kit available. See page 36 for details.



IONNIC 103 LED - 3 Bolt - Dual Colour

NEW

Clear Lens

- Amber/Blue **103800C**
- Amber/Green **103500C**
- Red/Blue **103700C**

Supplied with 3 x M6 bolts, nuts, shake-proof washers & base gasket.
Mounting: 3 x Ø 7mm holes @ 151 PCD.
700mm free length of cable.

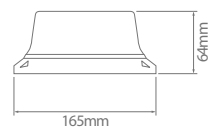

Beacons

IONNIC 106 LED

NEW



106000

12V 24V IP67 5Yrs

- SAE class 1 rated output.
- 12 flash patterns.
- Vibration resistance rated to SAE J575.
- Polycarbonate lens for high durability.
- Low current draw.
- 3 Bolt versions can be synchronised.
- Multi-voltage.
- Environmentally sealed – IP67.
- Magnetic version features cigar plug with integrated on/off & pattern select switches.
- 5 year warranty.

Voltage : 12–24V
Current Draw : 3.2A @ 12V
Flash Patterns : 12
Lens : Polycarbonate
Base : Aluminium
Vibration : SAE J575
Approvals : ECE R10, ECE R65 (Amber & Blue)
 SAE J845 Class1 (Amber)
Ingress Protection : IP67
Operating Temperature : -30°C to 50°C
Light Source : 18 x 3W LED



On/off and pattern select



106400C

Clear lens, red illumination

IONNIC 106 & 103 Series LED Beacons

The IONNIC 106 & 103 Series LED 3 Bolt beacons have the same 12 flash patterns and can be synchronised.

Flash Patterns

- | | |
|-------------------------|---------------------|
| 1 – Quad Burst | 7 – Slow Rotation |
| 2 – Quad Flash | 8 – Normal Rotation |
| 3 – Double Flash | 9 – Fast Rotation |
| 4 – Single Flash | 10 – Cycle Scan |
| 5 – Fast Flash | 11 – Steady On |
| 6 – Quad & Single Flash | 12 – Off |

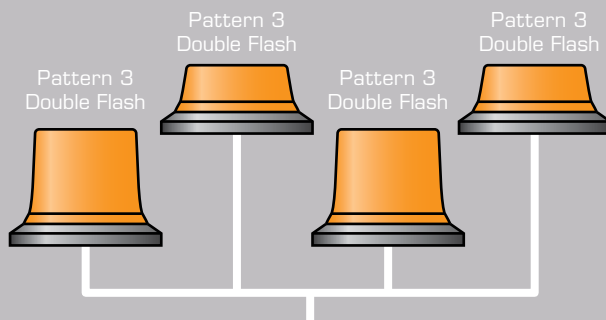



IONNIC 106 LED – 3 Bolt NEW

	Amber	Blue	Green	Red
Coloured Lens	106000	—	—	—
Clear Lens	—	106200C	106300C	106400C

Supplied with 3 x M6 bolts, nuts, shake-proof washers & base gasket.
 Mounting: 3 x Ø 7mm holes @ 151 PCD.
 230mm free length of cable.

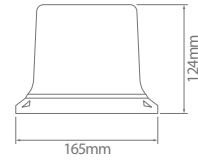

IONNIC 106 LED – Pole Mount NEW

	Amber
Coloured Lens	106002

Other colours available upon request, lead times apply.

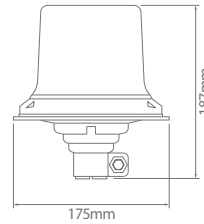

IONNIC 106 LED – Magnetic NEW

	Amber
Coloured Lens	106010

3.5m lead to cigar plug with on/off and pattern select switches.

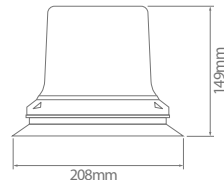

Beacons

Rotating LED



- True rotating LED.
- Heavy duty, virtually unbreakable.
- Patented 'Hybrid Drive' technology. No gears, no belts, no brushes.
- SAE Class 1 rated output.
- LEDs rated to 50,000 hours of operation.
- Low current draw.
- UV hard coated polycarbonate lens for high durability in harsh conditions.
- Magnetic version features 2600mm lead to cigar plug with integrated switch.
- Complies to over-dimensional vehicle regulations in several Australian states.
- 5 year warranty.

Voltage :	12-24V
Current Draw :	1.3A @ 12V
Wattage :	25.6W
Flash Rate :	120FPM
Lens :	Polycarbonate
Base :	Die-cast
Approvals :	ECE65, SAE J845 Class 1
Operating Temperature :	-30°C to 50°C
Light Source :	8 x 3W LED





Rotating LED – 3 Bolt

Coloured Lens	Amber 107000	Blue —	Green 107300	Red 107400	White —
Clear Lens	—	107200	—	—	NEW 107900

Supplied with 3 x M5 Bolts.
Mounting: 3 x Ø 5mm holes @ 151 PCD.
300mm free length of cable.

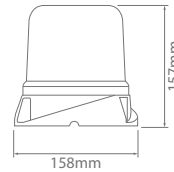

Rotating LED – Pole Mount

Coloured Lens	Amber 107002
---------------	------------------------

Other colours available upon request, lead times apply.

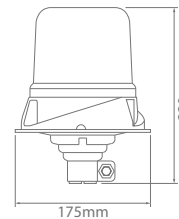

Rotating LED – Mag 60

Coloured Lens	Amber 108000
---------------	------------------------

2.6m lead to cigar plug with on/off switch.

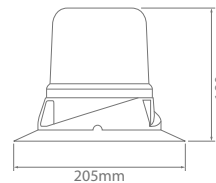

Rotating LED Technology

Patented Hybrid Drive technology – no gears, no belts, no brushes to wear out.

Vision Alert Rotating LED products avoid problems typically found in gear or belt driven beacons by using a direct-drive stepper motor. A direct-drive stepper motor has much greater reliability than a brushed DC motor with either a gear or belt assembly, because the only moving parts are the shaft and rotor which are supported by two sealed bearings.

The stepper motor uses magnetic induction to rotate the rotor and shaft so there are no gears to slip or belts to break and no electrical brushes or other contacts to wear out.



Rotating Light Output.

The light emitted from the 8 LEDs is collimated into a beam that shines straight up from the base. A double sided mirror is mounted to the shaft of the direct-drive stepper motor at 45° to intercept the beam and is rotated in a 360° circle to sweep the beam much like a standard halogen rotator.

Extended life of LEDs over alternative lighting.

By default LEDs provide a longer working life and greater resistance to vibration over alternative forms of lighting.

Additionally LEDs do not require the use of a costly and life limiting flash capacitor as required in flashing xenon beacons.

Lower current draw from LEDs.

LEDs require less current draw to provide an equal or greater light output compared to alternative lighting technologies.

- Rotating LED Beacon – 1.3A @ 12V
- Heavy Duty Xenon Beacon – 2.3A @ 12V
- Rotating Halogen Beacon – 4.6A @ 12V



Beacons

IONNIC 105 LED

105000



- Ultra high intensity LEDs – exceeds SAE class 1 rated output.
- 24 flash patterns including 2 simulated rotating.
- Heavy duty construction for increased durability.
- Epoxy encapsulated electronics for enhanced moisture & vibration protection.
- Low current draw.
- Multi-voltage.
- 3 Bolt versions can be synchronised.
- Magnetic version features cigar plug with integrated on/off & pattern select switches.
- Dimming function, 3 Bolt version only.
- 5 year warranty.

12V
24V

5Yrs

Voltage : 12–24V
Current Draw : 0.6A @ 12V
Flash Patterns : 24
Simulated Rotating Flash Rate : 78/162FPM
Lens : Polycarbonate
Base : Die-cast
Approvals : SAE J845 Class 1
Operating Temperature : -50°C to 55°C
Light Source : 8 x High Output LEDs



Exceeds Class 1 Rated Light Output

The IONNIC 105 LED beacon range features a unique 'balloon' lens that spreads and amplifies the light, producing in excess of Class 1 rated output from only 8 high output LEDs.



4 pairs of high output LEDs.



IONNIC 105 LED – 3 Bolt

Amber Blue Green Magenta ^{NEW} Red White
105000 **105200** **105300** **105600** **105400** **105500**

Supplied with 3 x M5 bolts, nuts & shake-proof washers.
 Mounting: 3 x Ø 5mm holes @ 151mm PCD.
 470mm free length of cable.

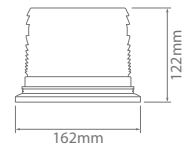

IONNIC 105 LED – Pole Mount

Amber
105002

Other colours available upon request.
 Preset to rotate light pattern.

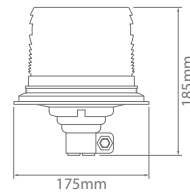

IONNIC 105 LED – Magnetic

Amber Blue Green Red White
105010 **105210** **105310** **105410** **105510**

3.4m lead to cigar plug with on/off and pattern select switches.

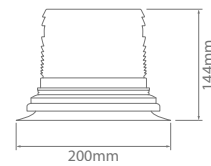

105 LED Series Lens

Part No.	Colour
910011	Amber
910022	Blue
910033	Green
910000	Magenta
910044	Red
910055	Clear



Beacons

IONNIC 101 LED



- SAE class 1 rated output.
- 5 flash patterns – 2 simulated rotating (120FPM).
- Polycarbonate lens for high durability.
- Epoxy encapsulated base for enhanced moisture & vibration protection.
- Low current draw.
- Multi-voltage.
- Environmentally sealed – IP67.
- Dimming function, 3 Bolt version only.
- Complies to over-dimensional vehicle regulations in several Australian states.
- 5 year warranty.

12V
36V

IP67

5Yrs

Operational Voltage : 12–36V
Current Draw : 2.8A @ 12V
Flash Patterns : 5
Lens : Polycarbonate
Base : Aluminium
Approvals : *excludes green ECE R65, SAE J845 Class1
Ingress Protection : IP67
Operating Temperature : -30°C to 50°C
Light Source : 12 x 3W LED

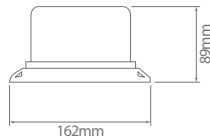

IONNIC 101 LED – 3 Bolt

Amber **101000** Green **101300** NEW

Supplied with 3 x M6 bolts, nuts, shake-proof washers & base gasket.
 Mounting: 3 x Ø 7mm holes @ 151mm PCD.
 340mm free length of cable.

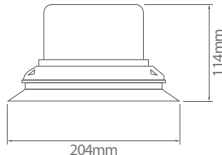

IONNIC 101 LED – Magnetic

Amber **101010** Green **101310** NEW

4.6m lead to cigar plug with on/off switch.
 Flash pattern preset to Quad flash.

- Ideal for forklift & other industrial applications.
- 6 flash patterns.
- Low profile design.
- Polycarbonate lens provides high durability against harsh conditions.
- Silicon filled base for enhanced moisture & vibration protection.
- Low current draw.
- Multi-voltage.



111000

12V
48V

Operational Voltage : 12-48V
 Current Draw : 0.2A @ 12V
 Flash Rate : 68FPM
 Flash Patterns : 6
 Lens : Polycarbonate
 Base : ABS
 Operating Temperature : -30°C to 50°C
 Light Source : 4 x 1W LED



Flash pattern selector

IONNIC 111 LED – 3 Bolt

Amber
111000

Supplied with 3 x M5 bolts, nuts, shake-proof washers & base gasket.
 Mounting: 3 x Ø 5mm holes @ 118 PCD.
 300mm free length of cable.

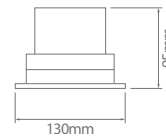

IONNIC 111 LED – Magnetic

Amber
111010

Cord extends to 3.0m length, plug fits standard cigar socket.
Not designed for highway use.

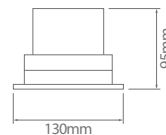

Beacons

Midi Vision

400001



- Free-form reflector provides 20% more light output over previous models.
- Whisper quiet rotators, running on stainless steel/acetal bearings.
- Polycarbonate lens provides high durability against harsh conditions.
- Multiple mounting configurations.
- Twist lock polycarbonate lens provides easy field maintenance.
- Magnetic models feature 2600mm retractable coil with cigar plug.
- Dual voltage motor.

Current Draw : 4.6A @ 12V 3A @ 24V
 Max. Wattage : 55W @ 12V 70W @ 24V
 Flash Rate : 160FPM
 Lens : Polycarbonate
 Base : ABS
 Light Source : H1 Halogen Bulb



Free-form optics generate greater & more focused light output



Twist lock lens provides easy field maintenance

Mag70
MAX
112
KM/H

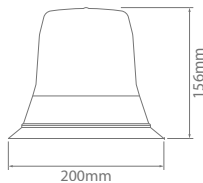

400 Series – Mag 70

	Amber	Cal. Blue	Green	Red
Less Bulb	400000	400200	400300	400400
12V	400001	400201	400301	400401
24V	400002	400202	400302	400402

Cord extends to 2.6m length, plug fits standard cigar/DIN socket.

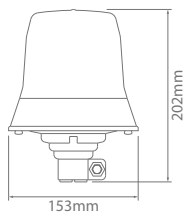

402 Series – Pole Mount

	Amber	Cal. Blue	Green	Red
Less Bulb	402000	402200	402300	402400
12V	402001	402201	402301	402401
24V	402002	402202	402302	402402

Single pole plug to DIN 72591.



403 Series – 3 Bolt

	Amber	Cal. Blue	Green	Red
Less Bulb	403000	403200	403300	403400
12V	403001	403201	403301	403401
24V	403002	403202	403302	403402

Supplied with 3 x M6 bolts, nuts, shake-proof washers.
Mounting: 3 x Ø 7mm holes @ 130 PCD.
300mm free length of cable.

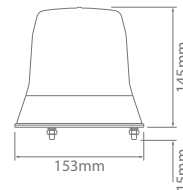

404 Series – Flexi

	Amber	Cal. Blue	Green	Red
Less Bulb	404000	404200	404300	404400
12V	404001	404201	404301	404401
24V	404002	404202	404302	404402

Flexible single pole plug to DIN 72591.

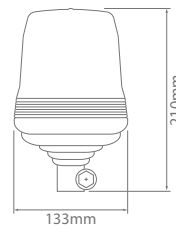

407 Series – Mag 50

	Amber	Cal. Blue	Green	Red
Less Bulb	407000	407200	407300	407400
12V	407001	407201	407301	407401
24V	407002	407202	407302	407402

Cord extends to 2.6m length, plug fits standard cigar/DIN socket.

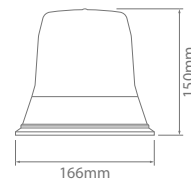

403 Series – 48V, 240V

	Amber	Cal. Blue	Green	Red
48V	403000-48V	—	—	—
240V	403000-240V	403200-240V	403300-240V	403400-240V

240 volt models must be installed by a qualified 240 volt electrician.
Cable gland clamping range – Ø 3.5mm.

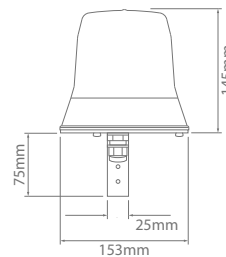

Midi Vision Lens

Part No.	Colour
910320	Amber
910321	Din. Blue
910322	Cal. Blue
910325	Green
910324	Red



Midi Vision Spares

Part No.	Description
999554	Rotator Module
910336	Reflector only
910030	Beacon Base
945034	Drive Belt
920004	Bulb Clip
64150	H1 Bulb – 12V, 55W
64155	H1 Bulb – 24V, 70W



Beacons

500 Series



503001

- Free-form reflector provides 20% more light output over previous models.
- Whisper quiet rotators, running on stainless steel/acetal bearings.
- Multiple mounting configurations.
- Twist lock acrylic lens provides easy field maintenance.
- Magnetic models feature 2600mm retractable coil with cigar plug.
- Dual voltage motor.

Current Draw :	4.6A @ 12V	3A @ 24V
Max. Wattage :	55W @ 12V	70W @ 24V
Flash Rate :	160FPM	
Lens :	Acrylic	
Base :	ABS	
Light Source :	H1 Halogen Bulb	



Free-form optics generate greater & more focused light output



Twist lock lens provides easy field maintenance

Free-Form Optics

All Vision Alert beacon & lightbar ranges incorporate Free-form optical technology.

This advancement in reflector design produces a more powerful and larger square beam increasing light output by 20% over previous designs.

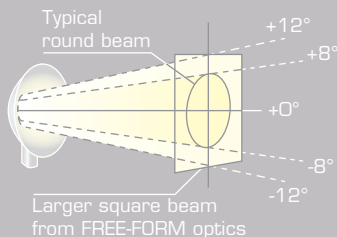

Dual Voltage

All Vision Alert halogen beacon & lightbar ranges use our proven dual voltage belt drive incorporating an updated version of our market leading, whisper-quiet rotators.

By changing the drive belt to the desired pulley and fitting the required voltage H1 bulb, any Vision Alert beacon or lightbar can be configured to suit 12V or 24V.

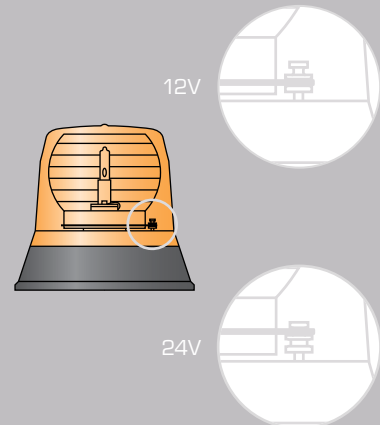



503 Series – 3 Bolt

	Amber	Cal. Blue	Green	Red
Less Bulb	503000	503600	503400	503500
12V	503001	503601	503401	503501
24V	503002	503602	503402	503502

Supplied with 3 x M6 bolts, nuts, shake-proof washers.
Mounting: 3 x Ø 7mm holes @ 130 PCD.
300mm free length of cable.

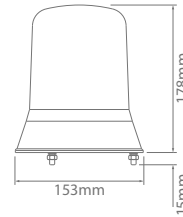

507 Series – Mag 50

	Amber
Less Bulb	507000
12V	507001
24V	507002

Cord extends to 2.6m length, plug fits standard cigar/DIN socket.

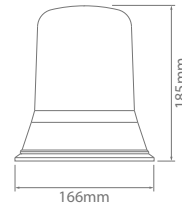

500 Series – Mag 70

	Amber	Cal. Blue	Green	Red
Less Bulb	500000	500600	500400	500500
12V	500001	500601	500401	500501
24V	500002	500602	500402	500502

Cord extends to 2.6m length, plug fits standard cigar/DIN socket.

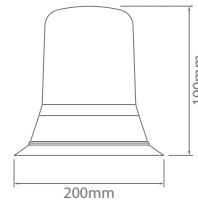

500 Series Lens

Part No.	Colour
910023	Amber
910024	Din. Blue
910028	Cal. Blue
910155	Green
910153	Red



500 Series Spares

Part No.	Description
999555	Rotator Module
910352	Reflector only
910030	Beacon Base
945034	Drive Belt
920004	Bulb Clip
64150	H1 Bulb – 12V, 55W
64155	H1 Bulb – 24V, 70W



Beacons

Heavy Duty Xenon



12V
24V

2Yrs

- Selectable Dual or Quad Flash.
- Energy saving xenon technology.
- Epoxy encapsulated base for enhanced moisture and vibration protection.
- "I-Beam" fault diagnostics LED.
- Multi-voltage.
- Die-cast base.
- 2 year warranty.

Voltage : 12–24V
Current Draw : 2.3A @ 12V
Flash Rate : 80/65FPM
Dual Flash Output : 10 Joules 7 Joules
Quad Flash Output : 16 Joules 10 Joules
Lens : Polycarbonate
Base : Die-cast
Cable Length : 300mm
Approvals : SAE J845 Class 2
Light Source : 1 x Xenon Tube



Vacuum Magnetic Mount Kit available. See page 36 for details.



A600VMK

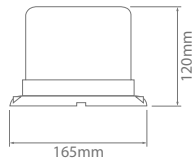

Heavy Duty Xenon – 3 Bolt

Amber **100263** Blue **100281** Green **100269** Red **100275**

Supplied with 3 x M5 bolts, nuts, shake-proof washers.
 Mounting: 3 x Ø 5mm holes @ 151mm PCD.

Heavy Duty Xenon Lens

Part No.	Colour
910391	Amber
910392	Blue
910393	Green
910394	Red
910395	Clear



Heavy Duty Xenon Spares

Part No.	Description
960055	Xenon Tube



- Energy saving xenon technology.
- Long life replaceable tubes.
- Twist lock polycarbonate lens provides easy field maintenance.
- Low current draw.
- Multi-voltage.

5832DO



Operational Voltage : 10-48V
 Current Draw : 1.4A @ 12V
 Flash Pattern : Double Flash
 Flash Rate : 75FPM
 Output : 6 Joules
 Lens : Polycarbonate
 Base : ABS
 Light Source : 1 x Xenon Tube

10V
48V

583 Series - 3 Bolt

Amber
5832DO

Supplied with 3 x M6 bolts, nuts, shake-proof washers.
 Mounting: 3 x Ø 7mm holes @ 130mm PCD.
 300mm free length of cable.

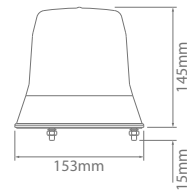

587 Series - Mag 50

Amber
5872DO

Cord extends to 2600mm length, plug fits standard cigar/DIN socket.
 Other colours available upon request

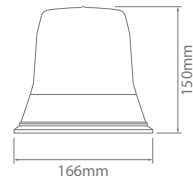

Midi Xenon Lens

Part No.	Colour
910136	Amber
910285	Din. Blue
910135	Cal. Blue
910134	Green
910133	Red
910139	Clear



Midi Xenon Spares

Part No.	Description
999223	Xenon Tube
910030	Beacon Base



Beacons

Mini Vision



10V
80V

- Compact size, ideal for forklift and other industrial applications.
- Energy saving xenon technology.
- Polycarbonate lens provides high durability against harsh conditions.
- Low current draw.
- Multi-voltage.

Operational Voltage : 10-80V
 Current Draw : 0.4A @ 12V
 Flash Pattern : Single Flash
 Flash Rate : 80FPM
 Output : 1.5 Joules
 Lens : Polycarbonate
 Base : ABS
 Cable Length : 300mm
 Light Source : 1 x Xenon Tube

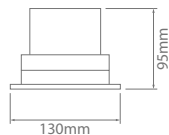

563 Series - 3 Bolt

Amber **563208** Blue **563C08** Green **563708** Red **563808**

Mounting: 3 x Ø 5mm holes @ 118 PCD.

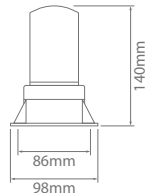

566 Series - 2 Bolt

Amber **566288** Blue **566C88** Green **566788** Red **566888**

Mounting: 2 x Ø 5mm holes.

Mini Vision Lens

563 Series	566 Series	Colour
910065	910085	Amber
910066	910086	Blue
910067	910087	Green
910068	910088	Red
910069	910089	Clear



Xenon Tubes

Part No.	Description
960085	563 Series
960012	566 Series



- Ideal for forklift applications.
- Value range of xenon beacons.
- Offered in high or low profiles.
- High profile model features epoxy encapsulated base.
- Low current draw.
- Multi-voltage.

Operational Voltage :	12-80V
Current Draw :	0.29A @ 12V
Flash Pattern :	Single Flash
Flash Rate :	6400A-1 36FPM
	6220A-2 72FPM
Output :	2 Joules
Lens :	Polycarbonate
Base :	ABS
Cable Length :	300mm
Light Source :	1 x Xenon Tube



12V
80V

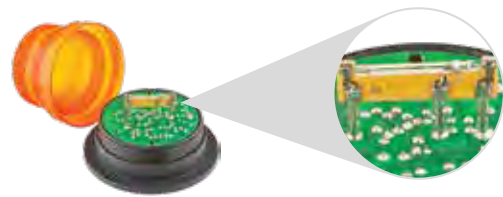

111000 LED version can be found on page 25.

IONNIC Mini Xenon – 3 Bolt

Amber
6400A-1

Supplied with 3 x M5 bolts, nuts, shake-proof washers.
Mounting: 3 x Ø 5mm holes @ 118 PCD.

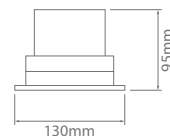

IONNIC Mini Xenon – 2 Bolt

Amber
6220A-2

Supplied with 2 x M5 bolts, nuts, shake-proof washers.
Mounting: 2 x Ø 5mm holes.

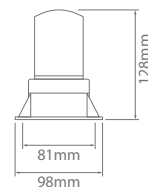

Beacon Accessories



DIN/Cigar Sockets

Part No.	Current Rating (A)	Type	Voltage	Cap Style	Terminal Style	Housing	Mounting \varnothing (mm)
1331001	12	DIN	—	Spring Loaded	Parallel	Brass	18
1331002	12	DIN	—	—	Parallel	Brass	18
1331003	12	DIN	—	Press Fit	Parallel	Brass	18
1331004	12	DIN	—	Spring Loaded	Offset	Brass	18
1331011	12	DIN	—	—	Parallel	Thermoplastic	18
1331005	12	DIN	—	—	Screw	Aluminium	—
1331006	16 total	DIN	—	—	Parallel	Thermoplastic	—
1331007	16	DIN	—	—	Parallel	Thermoplastic	—
1331008	15	Cigar	—	Press Fit	Offset	Stainless Steel	28
1331009	—	Cigar	12	—	Offset	Stainless Steel	28
1331010	20	Cigar	—	Press Fit	Offset	Stainless Steel	28



Adaptors & Extension Cables

Part No.	Description	Current Rating (A)	Cable (cm)	Housing
1334001	Cigar/DIN plug to cigar socket. 6-24V	2 x 5	20	Thermoplastic
1334002	DIN plug to cigar socket	12	—	Thermoplastic
1334003	Battery terminal clips to cigar socket	8	95	Thermoplastic
1334004	Cigar/DIN plug to DIN socket	8	385	Thermoplastic
1334005	Cigar/DIN plug to cigar socket	8	60 – 300	Thermoplastic

Beacon Accessories



1332001

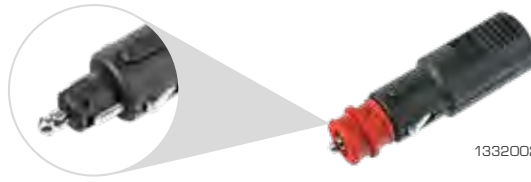

1332002



1332003

DIN/Cigar Plugs

Part No.	Current Rating (A)	Type	Housing	Notes
1332001	12	DIN	Thermoplastic	
1332002	12	Cigar/DIN	Thermoplastic	Incorporates strain relief
1332003	8	DIN	Thermoplastic	



Plug & Socket

Part No.	Description	Voltage	Output
1336010	2 Pin. Stainless Steel	12 – 24	20A



Sockets & Mounts NEW

Part No.	Description	Voltage	Output
1336000	Volt Meter. Displays 6V–29.9V	12 – 24	—
1336001	Socket – Power (cigar)	12 – 24	16A
1336002	Socket – Engel	12 – 24	15A
1336003	Socket – 5V Twin USB	12	1 x 1A, 1 x 2.1A
1336M01	Surface Mount – Single		
1336M02	Surface Mount – Double		
1336M03	Surface Mount – Triple		
1336M05	Panel Mount – Double		



Beacon Accessories



GRL-HD covering an IONNIC 106 LED beacon mounted to 905011

Protective Grilles

Part No.	Description	Maximum Height (mm)	Maximum Inside Ø (mm)
GRL	Standard duty	145	170
GR	Standard duty	195	170
GRL-HD	Heavy duty – 5mm cage	145	180
GR-HD	Heavy duty – 5mm cage	195	180



Shown attached to an IONNIC 106 LED Beacon

A600VMK shown attached to an IONNIC 101 LED Beacon

A600VMK

Mounting Plates for 3 Bolt Beacons

Part No.	Mounting	Description	PCD (mm)
905000	Flat surface	Beacon adaptor plate	130 – 151
905011	Flat surface	Suits protective grilles	130 – 151
905005	Flat surface	Suits Midi Vision, 500 Series, Midi Xenon	130
905001	90°	Suits Midi Vision, 500 Series, Midi Xenon	130
905002	90°	Suits Midi Vision, 500 Series, Midi Xenon	130
905003	Flat surface	Suits IONNIC 101, 103, 105, 106 LED, Rotating LED and Heavy Duty Xenon beacons	151
905009	90°	Suits IONNIC 101, 103, 105, 106 LED, Rotating LED and Heavy Duty Xenon beacons	151
A600VMK	Flat surface	Vacuum magnetic base and 4.6m lead to cigar plug with integrated on/off switch. Suits IONNIC 101, 103, 105, 106 LED, Rotating LED and Heavy Duty Xenon beacons	151

Beacon Accessories



Brackets & Extensions

Part No.	Description	Mount Style
1335001	Pole mount with integral DIN socket	Bolt down – 2 bolt
1335002	Pole mount with integral DIN socket	Weld
1335003	Pole mount with integral DIN socket	Threaded
1335004	Pole mount with integral DIN socket	Side mount – 2 bolt
1335005	Fold-down pole mount with integral DIN socket	Bolt down – 2 bolt
1335007	Adjustable pole mount extension – 740mm to 1300mm. Supplied with mounting hardware. Requires 1335002	

