

OKAY MOTOR PRODUCTS HANGZHOU INC.

杭州玉泉机车配件有限公司

# 汽车冷却系统热管理模块 THERMAL MANAGEMENT MODULES

Since 2007. 致力于提供 OE 同质化的汽车冷却系统解决方案。专注于热管理模块、执行器及高精度传感器的研发与制造。

Dedicated to providing OE-equivalent cooling solutions since 1997.

Specializing in R&D and manufacturing of thermal modules, actuators, and precision sensors.

# 核心规模与资质认证

CORE SCALE & CERTIFICATIONS

28+

批量热管理模块  
Mass Production Modules

150+

电子节温器品类  
Electronic Thermostats

500+

总产品种类  
Total Product Range



IATF 16949 / ISO 14001

国际质量与环境管理体系认证



High-Tech Enterprise

国家级高新技术企业



# 技术演进与产品迭代

TECHNOLOGY EVOLUTION & ITERATION

01

## 蜡式节温器 Wax Thermostat

利用石蜡相变原理控制循环，确保发动机稳定运行。

Phase-change control for engine stability.

02

## 电子节温器 Electronic Thermostat

ECU精确调节流量，提升响应速度与控温精度。

Precision ECU control for rapid response.

03

## 集成热管理模块 Integrated Module

多功能集成，支持复杂冷却回路的智能化管理。

Multi-functional integration for smart cooling.

04

## 未来趋势 Future Systems

高效、轻量、高集成化的热能管理中樞。

High-efficiency, lightweight thermal hubs.

# 全球品牌覆盖

GLOBAL BRAND COVERAGE

玉泉机车产品已全面覆盖全球主流豪华及通用汽车品牌。

截至2025年，我们以每年15-20款的速度猛增，研发速度领先同行一年以上。

As of 2025, we are expanding at a rate of 15-20 models annually, maintaining a R&D lead time of over one year over competitors.

宝马 / BMW

奔驰 / MERCEDES-BENZ

大众 / VW GROUP

通用 / GM / CADILLAC

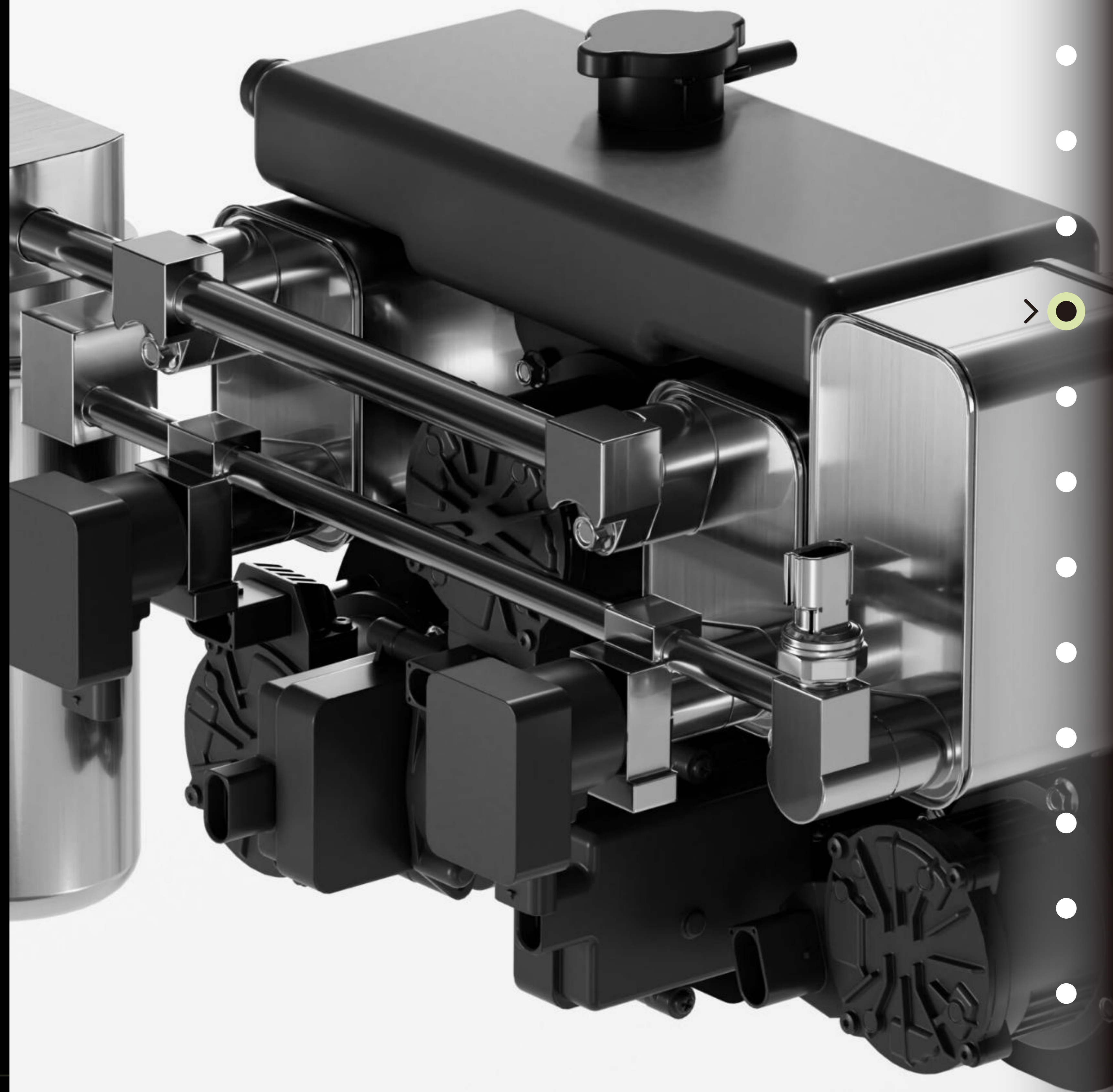

# 品牌品类开发进度表

DEVELOPMENT STATUS BY BRAND

品牌 / Vehicle Make	已开发 / Developed	预开发 / Pre-Development	核心型号 / Core Models
BMW (宝马)	6 Series	2 Series	11537644811 / 11538642560
BENZ (奔驰)	1 Series	1 Series	A2822034000
VW / AUDI (大众/奥迪)	2 Series	2 Series	06L121111L / 05E121111AB
GM / CADILLAC (通用/凯迪拉克)	8 Series	10 Series	55516367 / 55516370
HYUNDAI / KIA (现代/起亚)	3 Series	3 Series	256002M810 / 256002J100



# 技术案例：EA888 结构重构

CASE STUDY: EA888 REDESIGN

## 原厂结构 (OEM)

采用复杂的球阀结构，存在特定的售后痛点及专利限制。

Uses complex ball valve structure with OEM patent restrictions.

## 玉泉机车结构 (OKAY MOTOR)

**正向研发与优化：**取消球阀，引入更稳定的传统节温器结构，彻底规避专利风险。

Optimized stability; replaced ball valve with reliable thermostat design to avoid patents.

**该创新已申报欧盟及美国发明专利，实现 30% 以上的技术降本。**

EU/US patents pending; achieved over 30% cost reduction through re-engineering.

# 核心产品优势

CORE PRODUCT ADVANTAGES

## ✔ 免匹配安装 / Plug-and-Play

实现路跑数据全覆盖，极大降低售后安装难度。  
Data-matched installation, no calibration required.

## 🛡️ 高可靠性 / Extreme Reliability

5,000+ 只实际销量，目前保持零客诉记录。  
5,000+ units sold with zero customer complaints.

## 🚫 双重防漏 / Dual Leak Protection

采用国内原厂轴封与水封，确保超长使用寿命。  
Domestic OE-grade seals for maximum longevity.

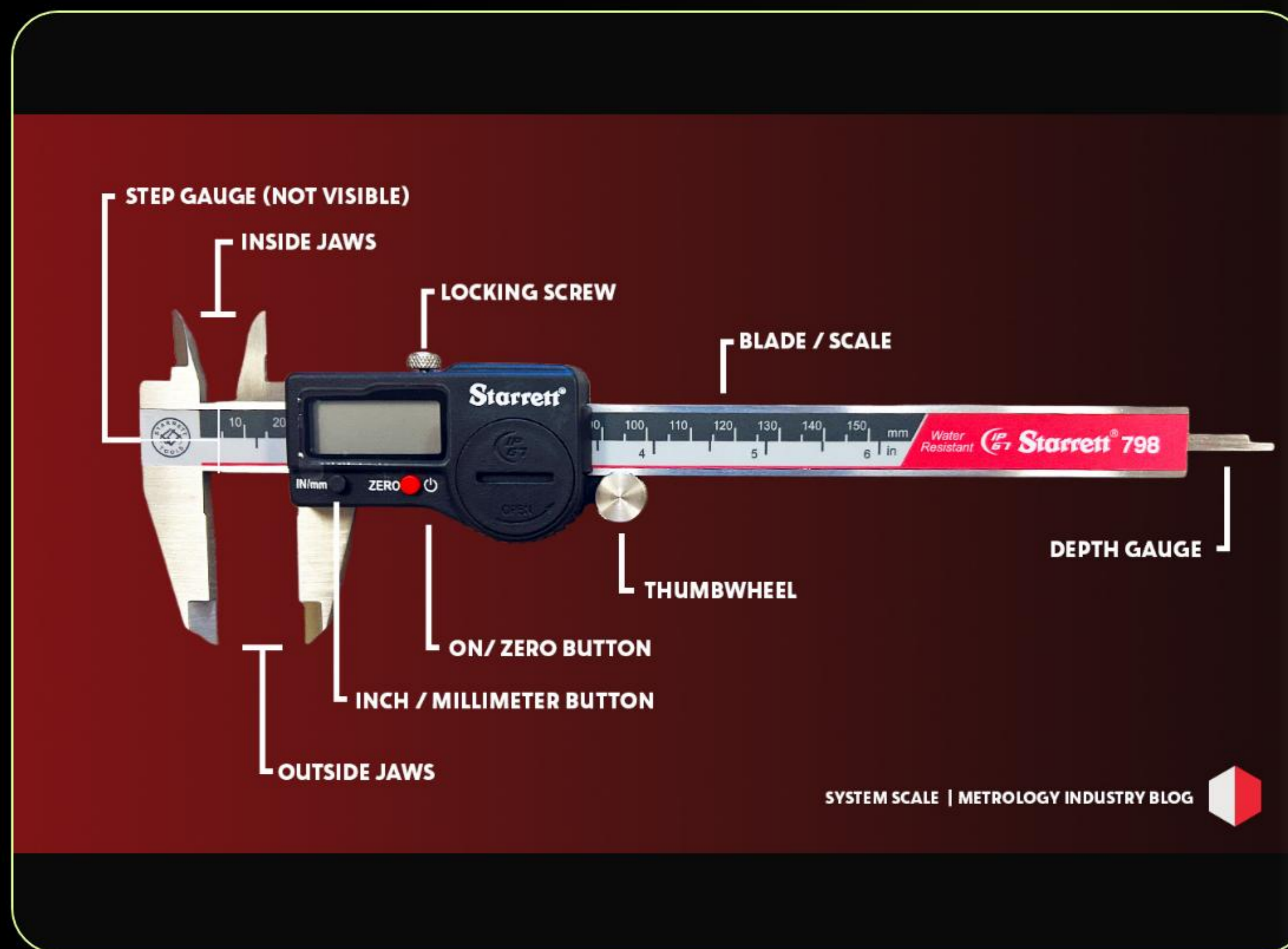

# 执行器控制技术

ACTUATOR CONTROL TECHNOLOGIES

我们成功掌握并量产了四种主流执行器控制协议。

We have mastered and mass-produced four mainstream actuator control protocols.



## SENT 协议

高精度数字协议

High-precision digital protocol



## LIN 协议

汽车局域网控制

Local Interconnect Network



## 占空比协议

PWM 脉衝宽度调製

Pulse Width Modulation



## 模拟信号

传统电压控制

Analog voltage control



# 卓越研发与技术团队

R&D EXCELLENCE & PARTNERSHIPS



## 跨国专家技术支持

玉泉机车背靠大陆集团 (Continental) 与上汽大众 (SAIC-VW) 的资深工程师团队。

具备全流程逆向开发与特性优化能力

自主设计 PCB 结构，从源头杜绝芯片专利风险

逐步建立完善的正向研发体系

*Full reverse engineering & autonomous PCB design capabilities with SAIC-VW and Continental background teams.*



# 严苛的实验测试标准

RIGOROUS LABORATORY TESTING

测试类别 / Category	测试内容 / Experiment Content	标准 / Standard
性能测试 / Performance	腔体拉力、高低温交替、第三方材料硬度分析 Cavity tensile, alternating temp, material hardness	IATF 16949
耐久测试 / Durability	节温器全流程曲线、加热器耐久、磨合测试 Thermostat cycle, heater durability, break-in	OE Quality
可靠性 / Reliability	气密性、盐雾、产品压力爆破实验 Air tightness, salt spray, burst test	Zero Leakage
电子兼容 / Electronics	CE 认证、EMC 电磁兼容报告 CE certification, EMC report	ISO/EMC



# 先进製造与材质解析

MANUFACTURING & MATERIALS



**自动化车间：**严格执行生产 BOM 表、工艺卡，确保每批次产品的高度一致性。

Automated workshop ensuring production consistency.



**顶级材质：**采用 DSM PA66-GF30 腔体材料及 PPS+CF+PTFE 密封组件。

Premium materials: DSM PA66-GF30 & PPS sealing components.

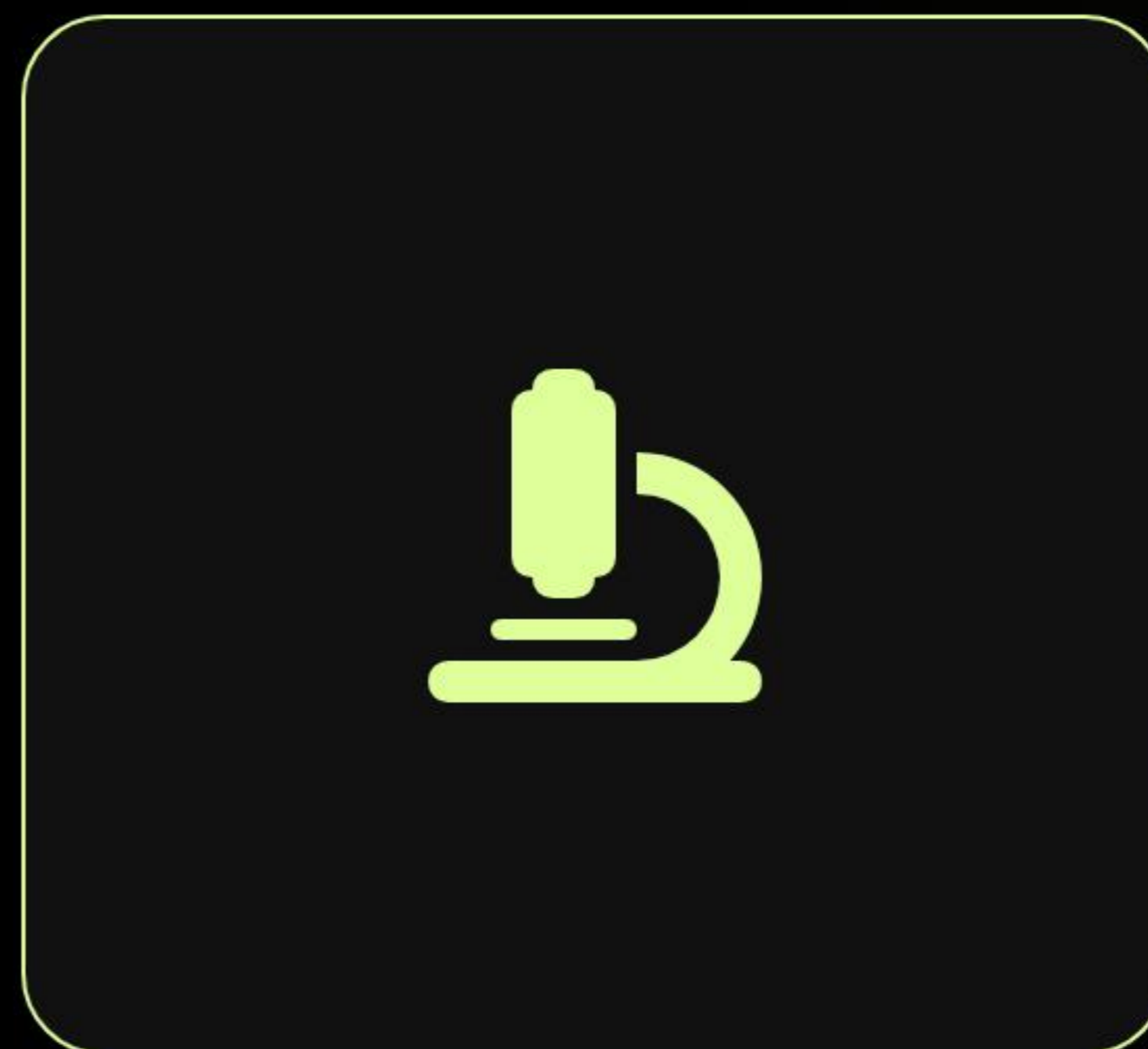

**精密控制：**全流程激光焊接工艺，主机同品牌橡胶胶圈。

Precision laser welding and OE-grade gaskets.





# 合作共赢，誓创精品







PARTNERSHIP FOR EXCELLENCE

玉泉机车始终坚持严选材料、严控流程。我们不懈奋斗，誓为客户提供性价比最高、质量最稳定的 OE 同质件，致力成为全球热管理行业的领先供应商。





OKAY MOTOR adheres to rigorous material selection and process control. We strive to provide the most cost-effective and stable OE-quality parts, aiming to be a global leader in thermal management.















OMP#	OEM NO.	PICTURE	REF#	APPLICATION
ETM A01075	9803549480 9850364680 3642484			CITROEN PEUGEOT
ETM A01076	9804160380 9849443980 1876476 2264810 DS7Q8A586AA DS7Q8A586AB			CITROEN PEUGEOT
ETM A03066	A2822034000 A2822036500			BENZ
ETM A03067	A2542003300 A2542035200			BENZ
ETM A04070	11537644811			BMW

ETM A04071	11537642854			BMW
ETM A04094	11538642560			BMW
ETM A04094-1	11539896578			BMW
ETM A04095	11538631943 11538843405			BMW
ETM A04095-1	11539896577			BMW
ETM A04096	11538642559 11538843406			BMW

ETM A04099	11538685978 11538602282			BMW
ETM A04103	11539468426			BMW
ETM A05241	06L121111L 06K121600D 06L121111K 06L121111J			VW
ETM A05282	05E121111K 05E121111AB 05E121111R			VW
ETM A05292	05L121111F 05L121111H 05L121111J 05L121111P			VW
ETM A05293	05L121111S			VW

<p>ETM A07044</p>	<p>55516367 55512101 55509070 55512103 55516369 55509072</p>			<p>OPEL Chevrolet VAUXHALL</p>
<p>ETM A07045</p>	<p>55516370 55512102 55512104</p>			<p>OPEL Chevrolet VAUXHALL</p>
<p>ETM A07046</p>	<p>12721318 12735499 55516366</p>			<p>OPEL Chevrolet VAUXHALL</p>
<p>ETM A07047</p>	<p>68312761AD 50552351 68312761AC 8312761AA 50544548 50556087 50049078</p>			<p>Alfa Romeo Giulia 2.0 16'-24' Alfa Romeo Stelvio 2.0 16'-24'</p>
<p>ETM A07049</p>	<p>5551174 5551172 1320000 24001355 55508607 55512723 24000390</p>			<p>OPEL Chevrolet VAUXHALL</p>

ETM A10018	21319AA010 21319AA040			SUBARU
ETM A10019	PYFB1516ZA PYFD1516Z PYFD1516ZA			MAZDA
ETM A10025	PYFA1516ZB PYFA1516ZA			MAZDA
ETM A11005	256002M810			KIA HYUNDAI
ETM A11006	256002M000 256002M002			KIA HYUNDAI
ETM A11007	256002M052 256002M050			KIA HYUNDAI

ETM A11008	256002M800			KIA HYUNDAI
ETM A11009	256002S000 256002S001			KIA HYUNDAI
ETM A11010	256902U000			KIA HYUNDAI
ETM A11011	256002J100 256002J110			KIA HYUNDAI
ETM A11012	256002J001 256002J010			KIA HYUNDAI
ETM A11013	2560007600			KIA HYUNDAI
ETM A11014	2560008100			KIA HYUNDAI

ETM A11015	2560008200			KIA HYUNDAI
ETM A11016	2560007500 2560008000			KIA HYUNDAI
ETM A11017	256002S501 256002S500			KIA HYUNDAI
ETM A13001	1306600XEC51			长城
ETM A13002	1306600XEC71			长城
ETM A13003	1306600XEC61			长城
ETM A13004	1306600XEB06			长城哈弗H6三代/初恋/赤兔/酷狗/大狗/枭龙 1.5T