



*CHALTRON*

*SYSTEMS, INC.*

# **Advancements in Clamp-on Ultrasonic Flow Measurements**

The Operator Training Committee of Ohio, Inc  
March 8<sup>th</sup> 2017

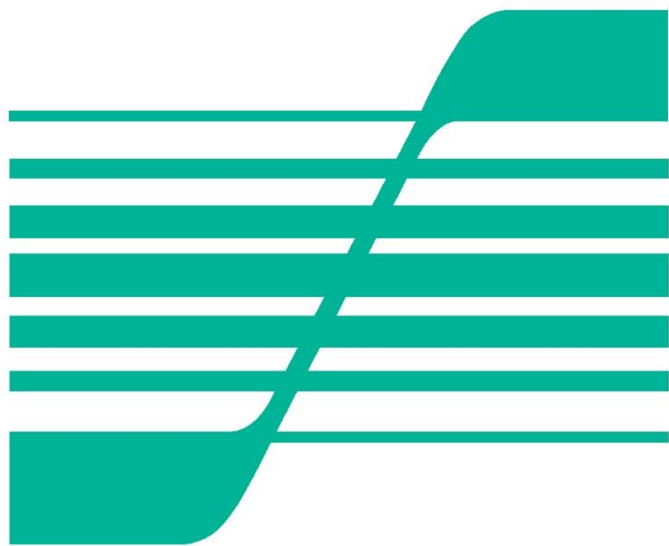

**FLEXIM**





# Market Leader in Clamp-On Ultrasonic Flowmeters with >50,000 instruments sold





## Background Information

- Extraordinary performance over the last 10 Years
- > 25% of investments put into Research & Development
- Privately owned Company – 26 Years
- Protected by international patents
- Unique adaptive Dual- $\mu$ C signal processing





# Clamp-on Technology Leader

- More than 150 man-years of combined application knowledge
- Widest application range on the market
- Permanent Coupling Pads – NO GREASE!
- Rugged Design for all Environments





# Technology: Types of Ultrasonic Flow Meters





# Doppler Measurement

Doppler meters use sound pulse reflection principle to measure liquid flow rate, solids or bubbles in suspension in the liquid reflect the sound back to the receiving transducer.

Assumption - Reflected particle is representative of the average flow.

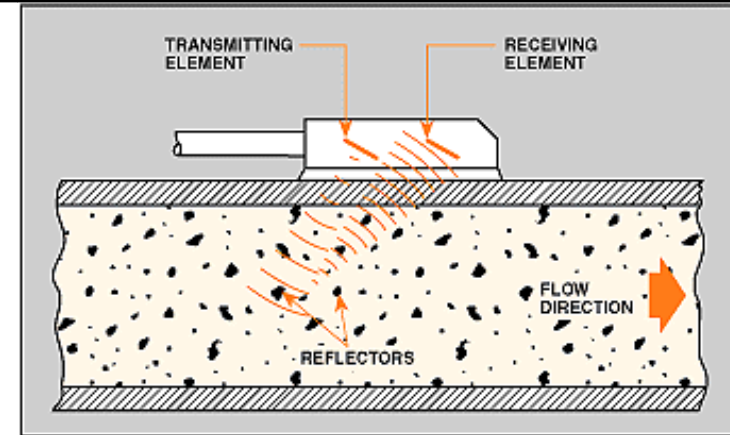



# Doppler Measurement

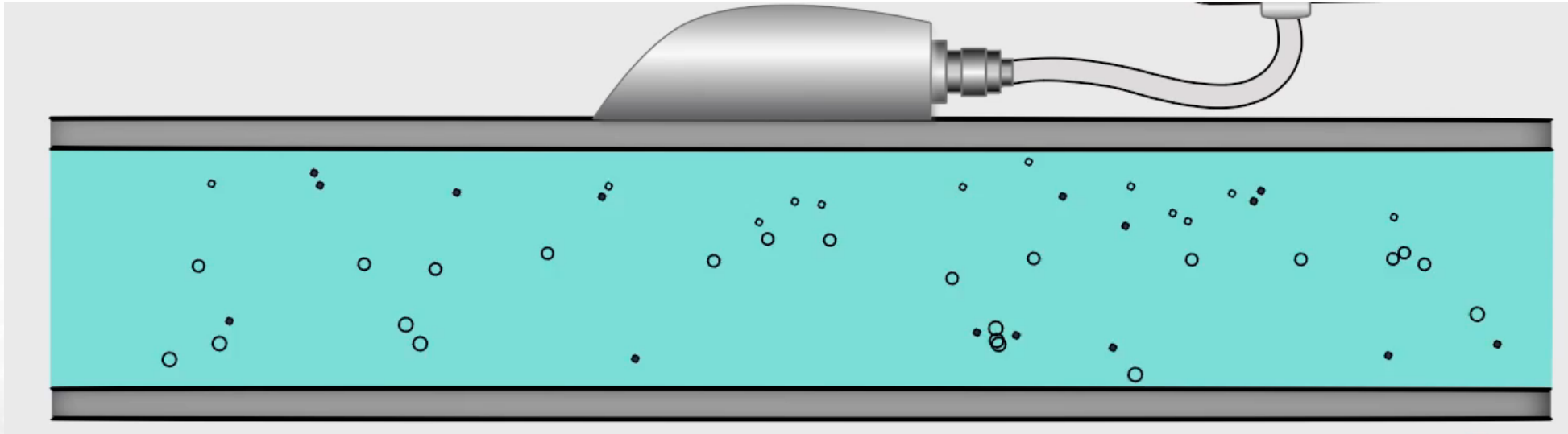
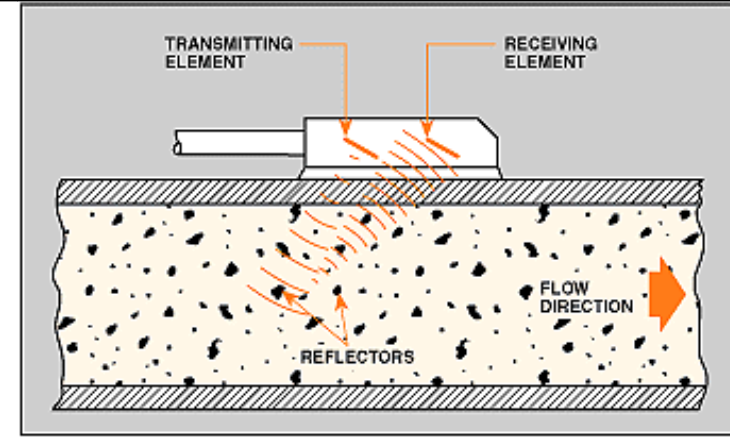





# Transit Time Measurement

Two Ultrasonic Transducers alternatively emit and receive signals protruding into the pipe

The Signal going with the flow travels the distance faster than the one against the current

This time difference is measured and allows for the calculation of the flow velocity and the volume flow rates

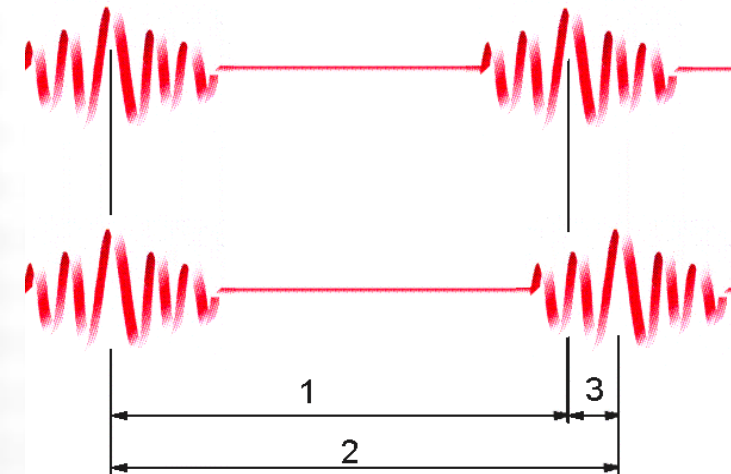
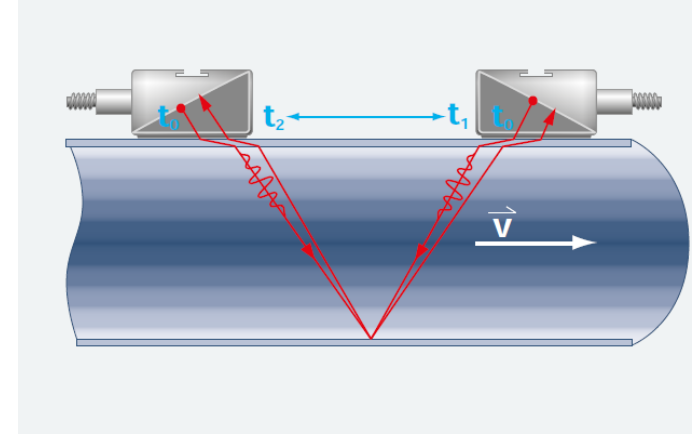



## Measurement Principle – Transit Time (Video)

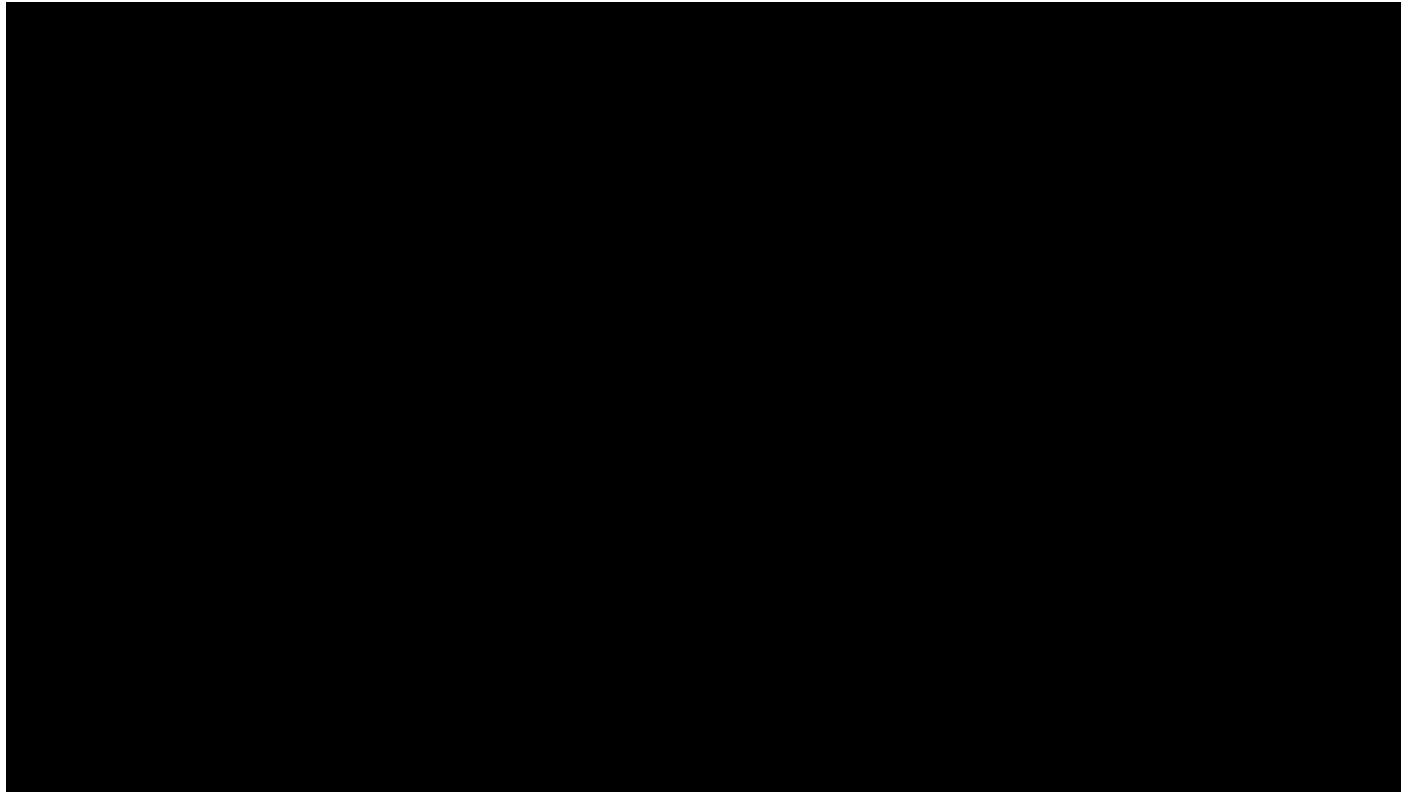



# HybridTrek

In media with higher solids content (>10%) such as sludge's, where the ultrasonic signal becomes attenuated, the meter can automatically shift to Noisetrek (Doppler).

The frequency shift of the ultrasonic signal is measured by the particles floating in the liquid, providing a continuous measurement during upsets in the process.

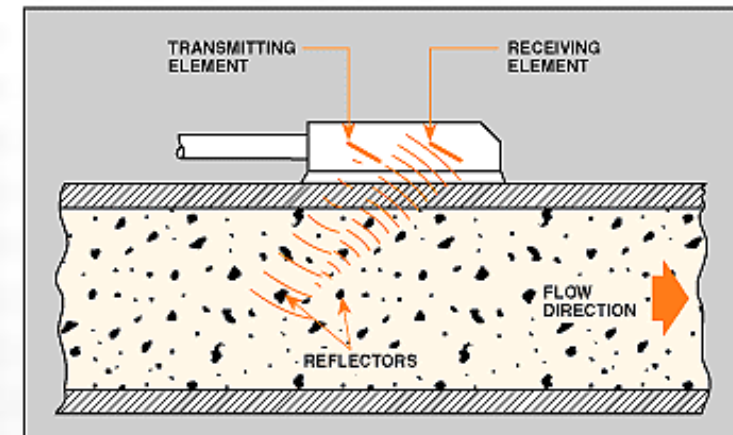
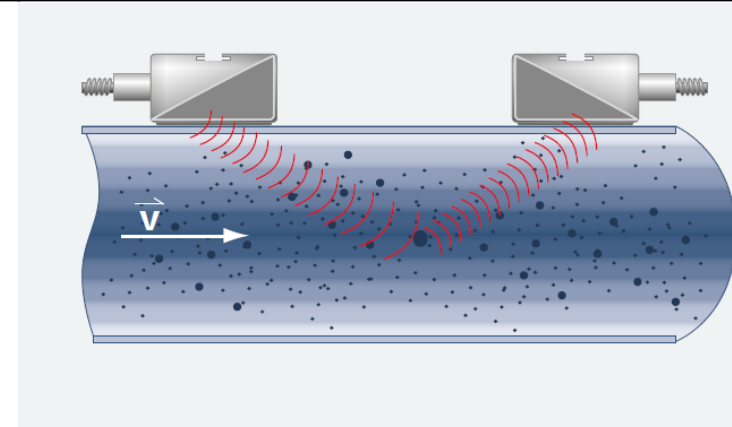



# **Advancements in Electronics and Signal Processing**



# Measurement Principle – Transit Time

FLEXIM's flow meters measure according to the Transit-Time principle.

Transit-Time is inherently bi-directional

Flexim has a wide range of transducers for all applications

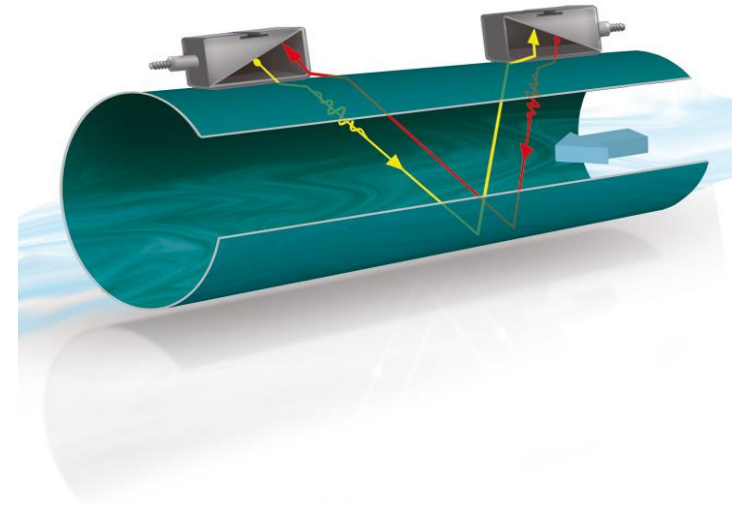

$$Q = A \cdot k_{re} \cdot v_e$$

mit  $v_e = \frac{\Delta t}{2t_{tr}}$

$$\Leftrightarrow Q = A \cdot k_{re} \cdot \frac{\Delta t}{2t_{tr}}$$

mit  $k_{re} = f(r_e)$   
mit  $r_e = \frac{v_{re} \cdot d_i}{v}$

$$\Leftrightarrow Q = A \cdot \frac{v_{re} \cdot d_i}{r} \cdot \frac{\Delta t}{2t_{tr}}$$



# Highly Accurate Signal Processing

- FLEXIM's flow meters generate up to 1,000 signals per second.
- Internal DSP allows for fast and secure processing of these signals

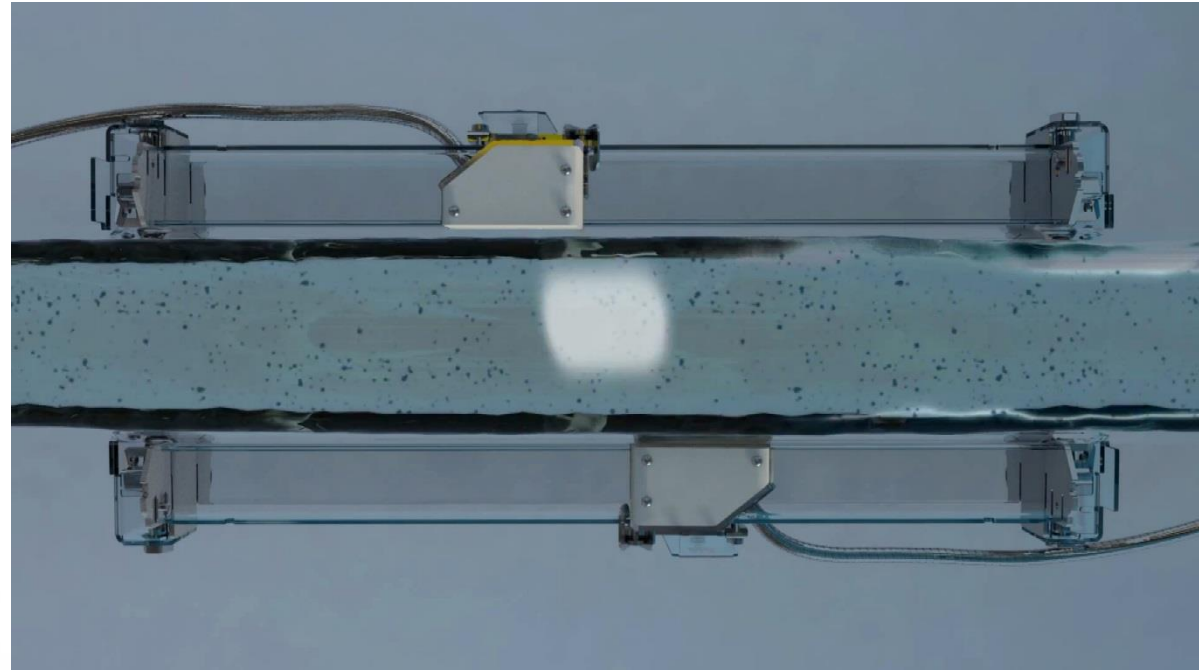



# Highly Accurate Signal Processing

- FLEXIM's superior noise and correction algorithms along with the DSP guarantee, that signals are fully processed and noise is significantly suppressed
- Automatic variable gain control adapts to the process to provide a reliable signal

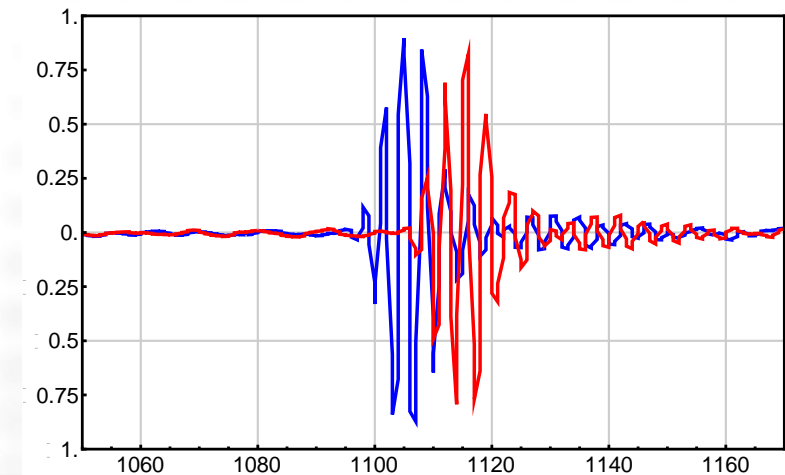
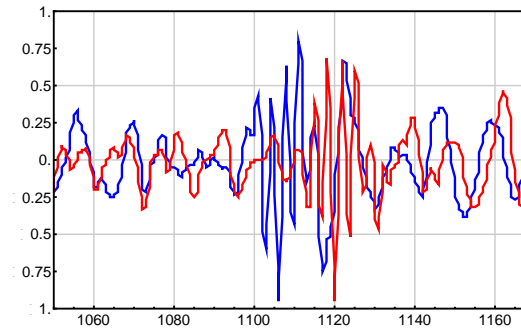



# Highly Accurate Signal Processing

- Flexim Correlates up to 200 points of waveform between upstream and downstream measurements
- Other Ultrasonic meters measure time at only 1 point, that point can shift due to temperature changes

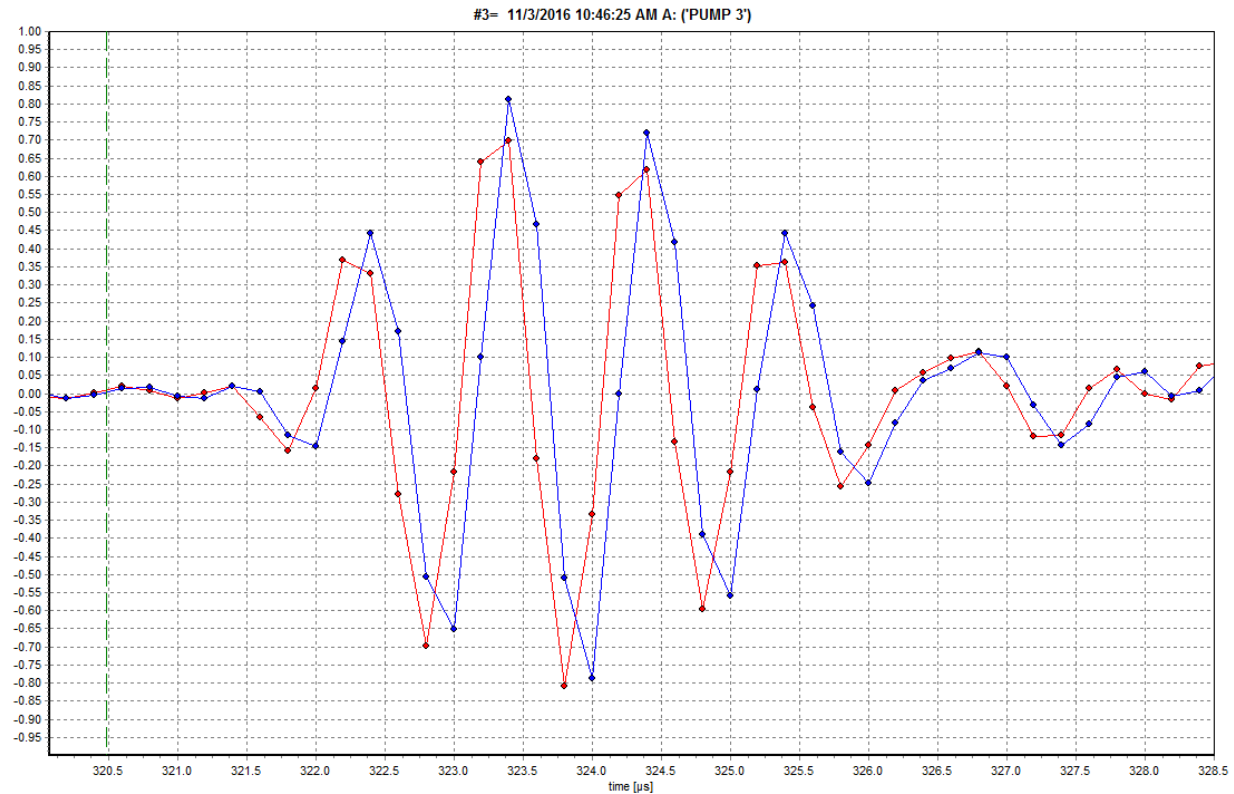





# Highly Accurate in Non-Ideal Situations

- All FLEXIM flow meters can be equipped with two (4 Beam) or four (8 Beam) flow channels to compensate for non-ideal flow profiles
- Channels are averaged together and provided as one output

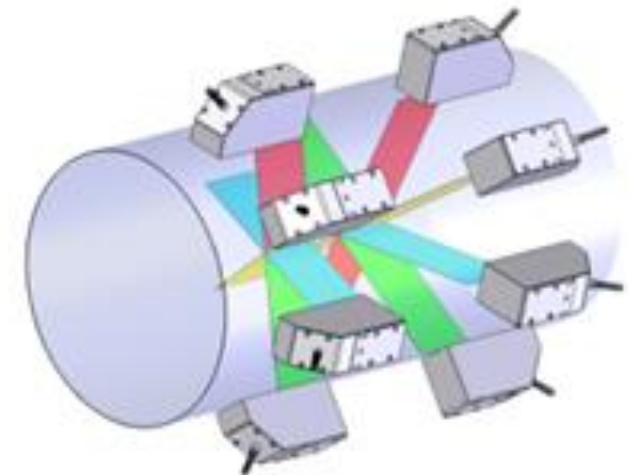
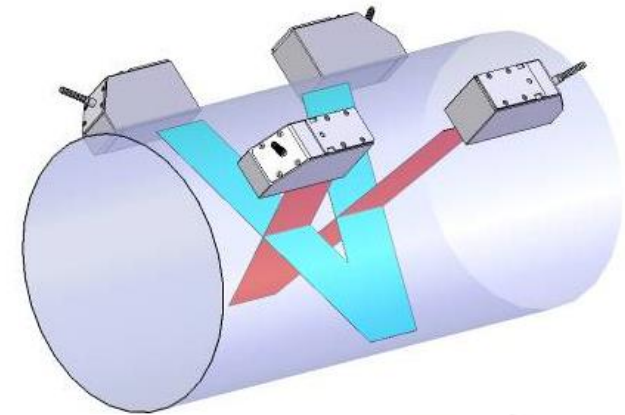



# Short Run - Cross Flows

- Cross Flow Compensation
- Flexim meters have the ability to mitigate error associated with short straight runs

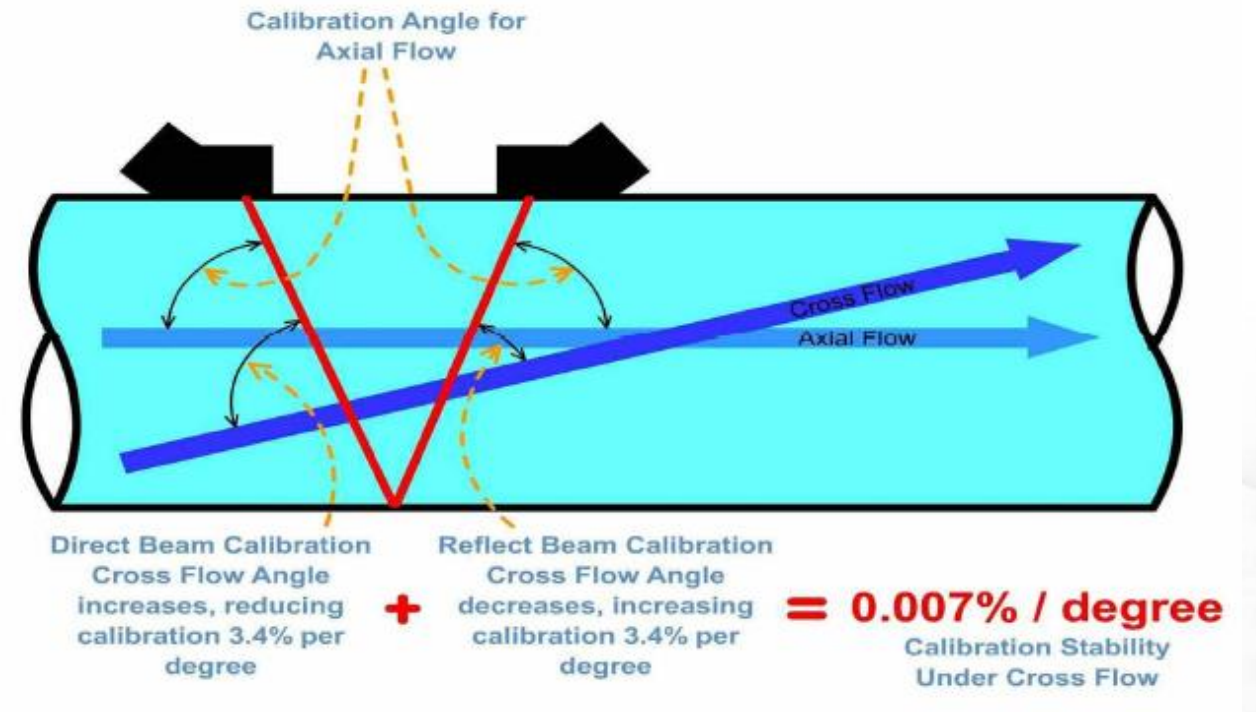



# Diagnostic Parameters

- Each measurement can be evaluated by using numerous diagnostic parameters:
  - Signal Strength, Signal Quality, SNR, SCNR, Gain, Soundspeed
- Ensures an optimal operation at installation
- Provides baseline diagnostics for future verification

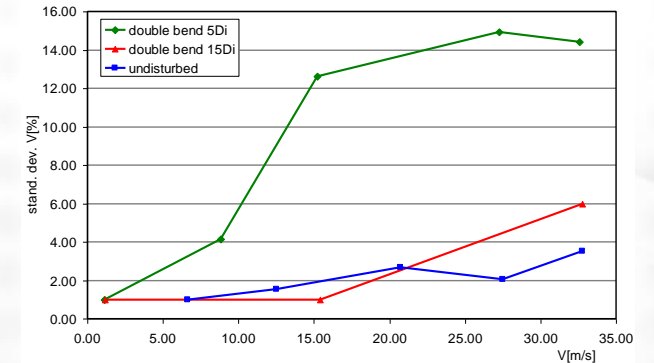
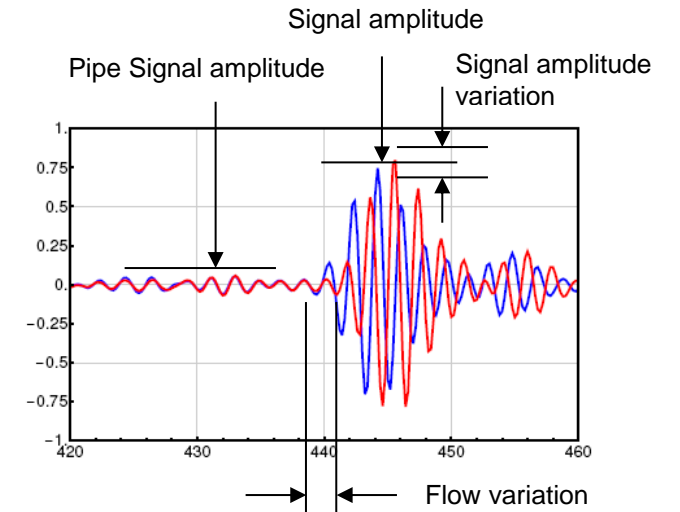



# Unique Transducer Design

## Transducer SENS-Prom:

- Fool-Proof Transducer Detection
- Auto Transducer Recognition and Calibration Upload
- Ensures an Unchangeable Accuracy – Calibration Resides with Transducers

## Matched & Temperature Compensated Transducers

- Enables Drift Free Measurement
- Eliminates Zeroing in the Field
- Provides Reliable Measurement Under Difficult Conditions





# **Advancements in Hardware and Physical Design**



# Rugged Solution

## Transducers and Transmitters:

- Transducers are resistant to chemicals (PEEK), watertight (IP68) and hazardous areas (FM) approved
- Stainless Steel armoured transducer connection cables ensure no weak junctions
- Transmitters are available as hazardous area approved versions (FM Class I, Div. I and II) with intrinsic safe outputs

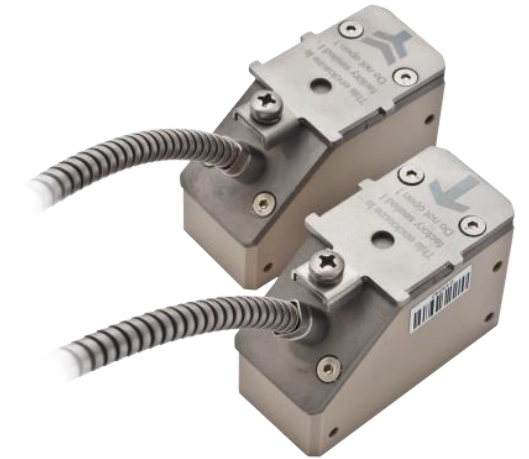



# Rugged Solution

## Mounting Fixtures:

- Stainless Steel (SS 304 and SS 316) PermaLok mounting fixtures for optimal protection
- Fully gasketed enclosure
- Designed for rough environments guaranteeing long term stability





# How Flexim has Solved Typical Ultrasonic Failure Points







## **Problem: Coupling Compound Between Pipe and Transducer**

**Solution:** *Flexim Uses Rubber Coupling Pads –  
No More Grease. No More Maintenance*





# Problem: Corrosion/Failure of Transducer Connection

**Solution:** *Flexim Uses Sealed Potted Cable Connections. No Twist-on Type Connectors*

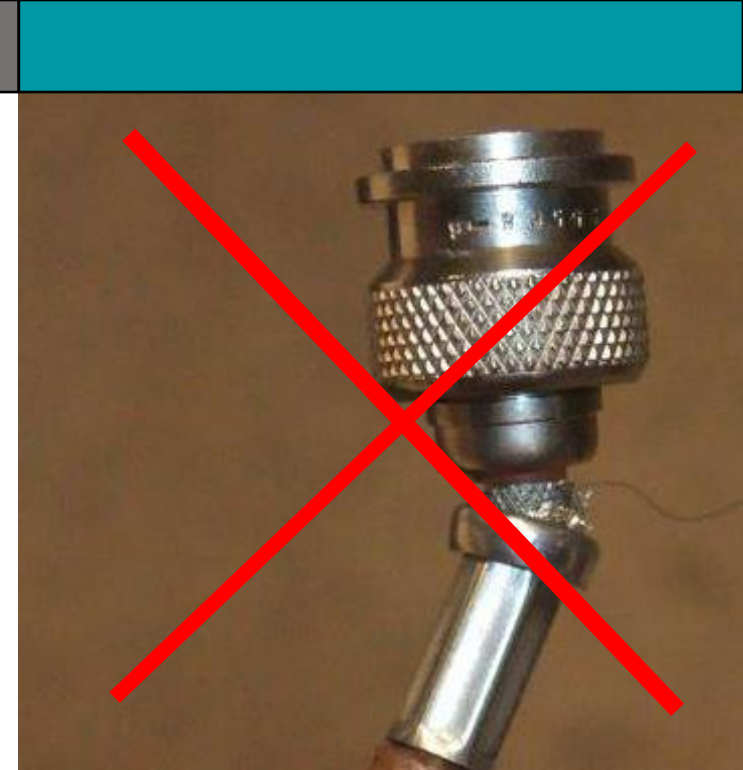

12 Points of Potential Failure for Corrosion in 1 Measurement Point

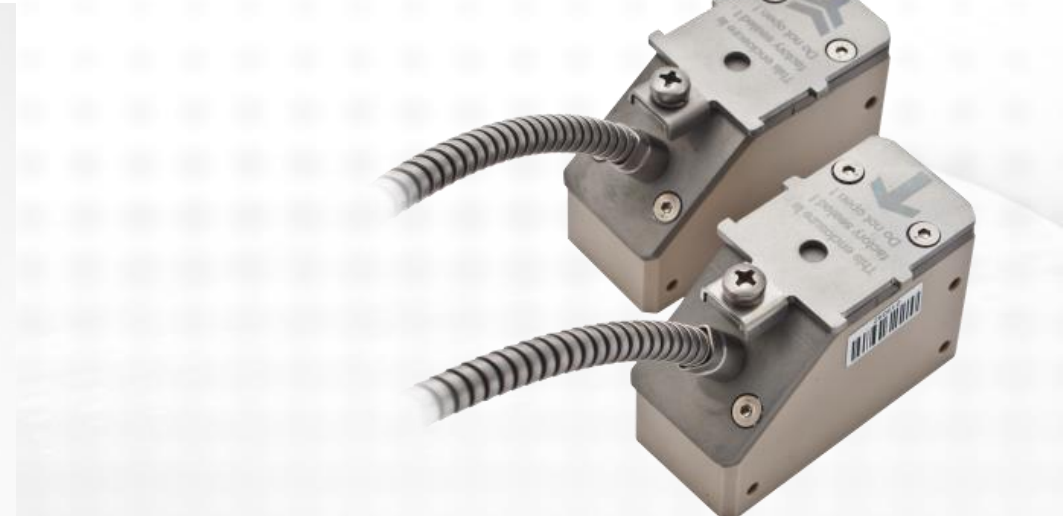
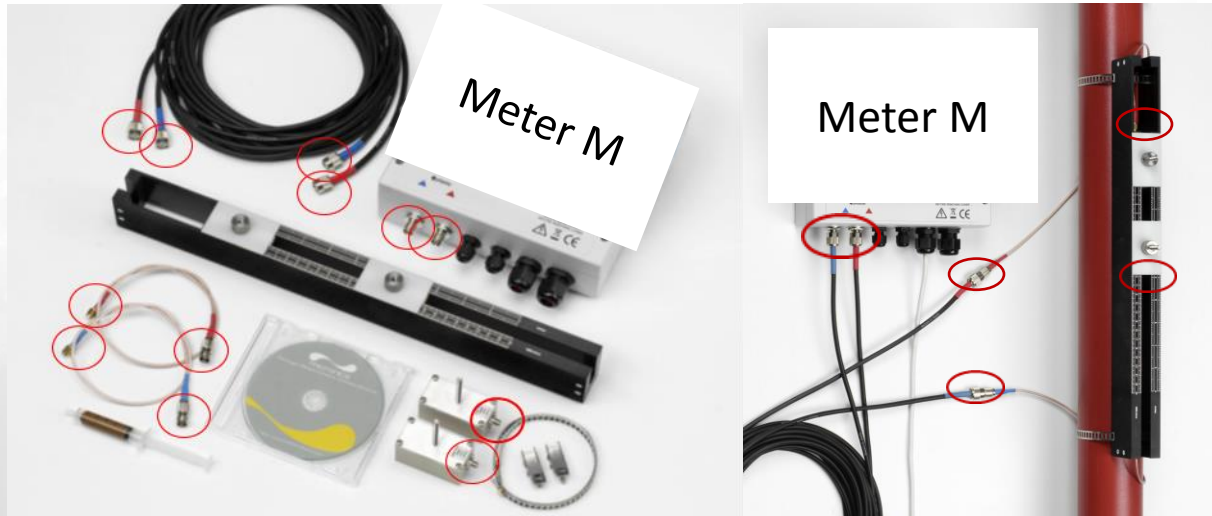



# Problem: Damage to Transducer Cables

**Solution:** *Flexim Uses Stainless Steel Armoured Cable. No Un-Protected Coax Wires*





# Problem: Field Zeroing Required – Full Pipe No Flow on Installation

**Solution:** *Flexim Pre-Zero's Meters During Wet Flow Calibration Ensuring Accuracy (NIST Traceable)*

**Kalibrierschein  
Calibration Certificate**

Teilgerät / Device under test (DUT)

Teil: K5000  
Typ: K5000  
Ordnung: 40414  
Ser.Nr.: 014970  
Hersteller: GEMET  
Ser.Nr.: 1476  
Temperatur: 20.0 °C  
Medium: Wasser  
Druck: 1.0 bar  
Ser.Nr.: 1.2

Kalibrations-Nr.: 010007-010  
Aufgaben: 100  
Ser.Nr.:  
Hersteller:  
Ordnung:

Temperatur: 20.0 °C  
Druck: 1.0 bar  
Ser.Nr.: 1.2

Messergebnisse / Test results

Meßpunkt Meas. Point	Messwert Meas. value	Nennwert Nominal	Abweichung Deviation	Rel. Abw. [%] Rel. Dev. [%]	Genauigkeit Accuracy	Streuung Dispersion	Einheit Unit
1	0.00	0.00	0.00	0.00	0.00	0.00	m³/h
2	0.00	0.00	0.00	0.00	0.00	0.00	m³/h
3	0.00	0.00	0.00	0.00	0.00	0.00	m³/h
4	0.00	0.00	0.00	0.00	0.00	0.00	m³/h
5	0.00	0.00	0.00	0.00	0.00	0.00	m³/h
6	0.00	0.00	0.00	0.00	0.00	0.00	m³/h
7	0.00	0.00	0.00	0.00	0.00	0.00	m³/h
8	0.00	0.00	0.00	0.00	0.00	0.00	m³/h
9	0.00	0.00	0.00	0.00	0.00	0.00	m³/h
10	0.00	0.00	0.00	0.00	0.00	0.00	m³/h

Die angegebene Messgröße erfüllt die in unserer Spezifikation angegebenen Genauigkeitskriterien (Genauigkeit, Streuung).  
The indicated measurement meets the accuracy and dispersion criteria of the specification (accuracy, dispersion).

Die Kalibrierung des oben angegebenen Meßgerätes wurde gemäß ISO 9001 gegen Normale durchgeführt, die sich auf nationale Standards rückführen lassen.  
The calibration of the indicated meter was carried out against standards which are traceable to national standards in accordance with ISO 9001.

Hersteller: GEMET  
Ser.Nr.: 014970  
Druck: 1.0 bar  
Temperatur: 20.0 °C

Ordnung: 40414  
Ser.Nr.: 014970  
Hersteller: GEMET

Datum: 27.08.2010  
Ordnung: 40414  
Ser.Nr.: 014970  
Hersteller: GEMET

Flexim Messtechnik GmbH  
FLEXIM GmbH, Maxime Str. 30, D-10551 Berlin, Tel: +49 30 2600 1000





## Problem: Meters Drift Based on Ambient Temperature Changes

**Solution:** *Flexim Temperature Compensates with Embedded RTD's*

*Meets the ANSI/ASME MFC-5M-1985 Standard*

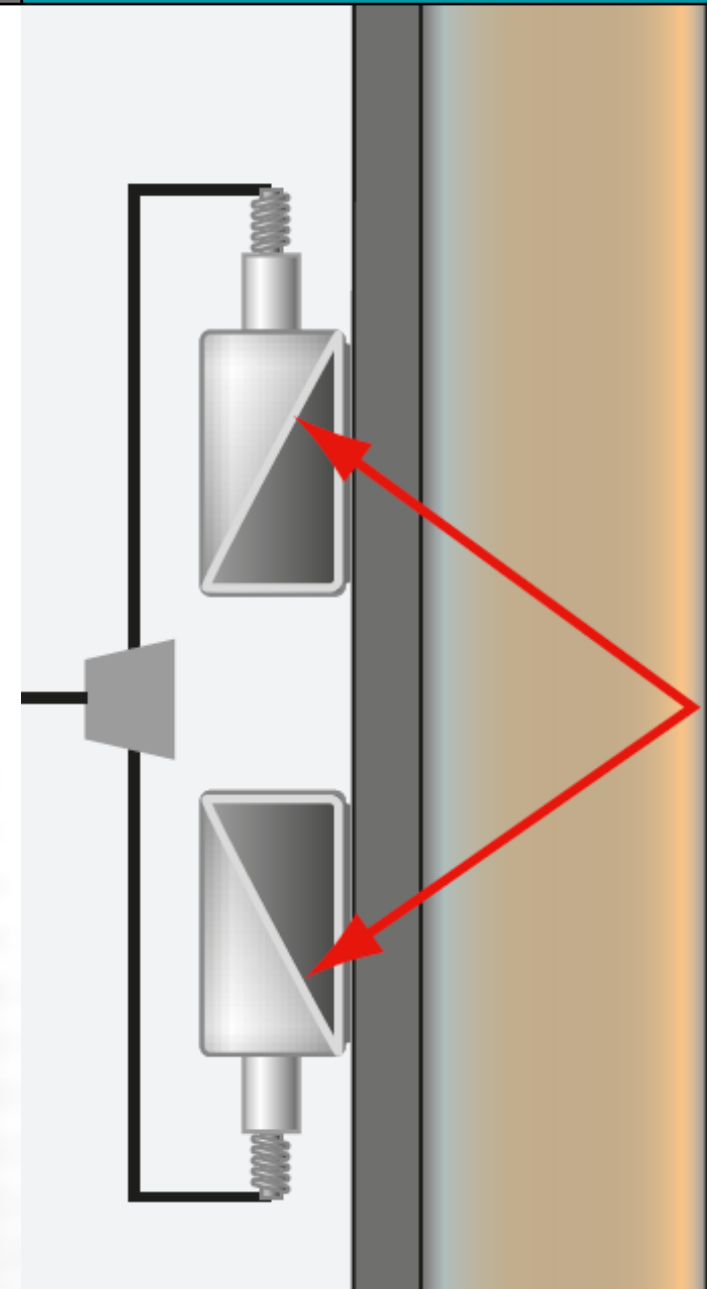



# Problem: Poor Mounting / Transducer Movement on Pipe

**Solution:** *Flexim Has Rugged PermaLok  
Mounting Track*





# Problem: Turn Down Ratio / Low Flows

Solution: *Bi-Directional - Unlimited Turn Down Ratio*

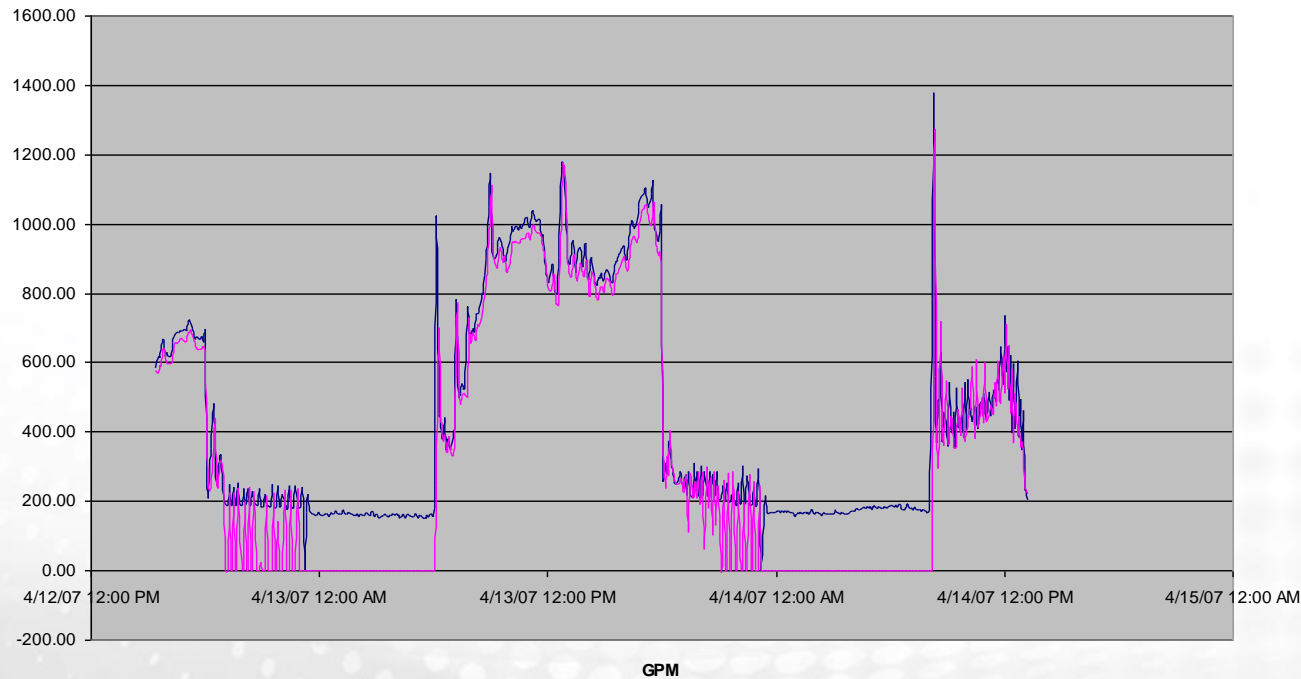



# Clear Advantages of FLUXUS – Liquid Flow Measurement







# Physical Limitations - None

- From ¼" Tubing Lines up to 256" Pipes
- Measurement in Every Environment – Including Submergence (IP68)
- No Limitation on Wall Thickness or Pipe Material
- Inherently Bi-Directional Measurement
- Unlimited Turndown Ratio – Highest Accuracy from Very Low up to High Flow Rates (0.01 ft/sec to >200 ft/sec) XLF down to 0.001 ft/sec
- Independent of Pipe Wall Temperatures -260 °F. to >1150 °F.
- Measurement of Virtually any Liquid – Independent of Entrained Particles or Gas Bubbles due to HybridTrek Mode





# Highly Cost Efficient

- Meter Cost is Independent of Pipe Diameter or Internal Pressure
- No Process Shut-Downs
- No Maintenance
- No Internal Pressure Drops





# Applications in Water and Waste





# NEORSD – Easterly Plant 48" RAS Lines

- Pipe Size: 48" Ductile Iron with .25" Cement Liner
- Dual Beam Meter to Overcome Short Straight Run
- PermaLok Mounting Tracks with Permanent Coupling Pads – No Maintenance





# Cincinnati MSD 8" Sludge to Incinerator

- Pipe Size: 8" SCH 80 Carbon Steel
- High Power Low Frequency G Sensors
- 2 Path Transit-Time Measurement
- 25-30 % Solids
- Schwing Alternating Piston Pumps
- Flow Velocities 0.02 to 0.35 feet/sec





# Cincinnati MSD 8" Sludge to Incinerator

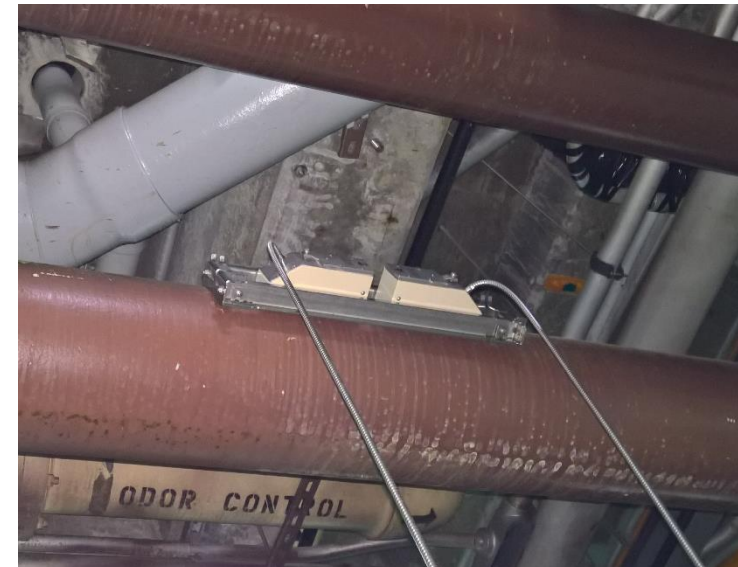
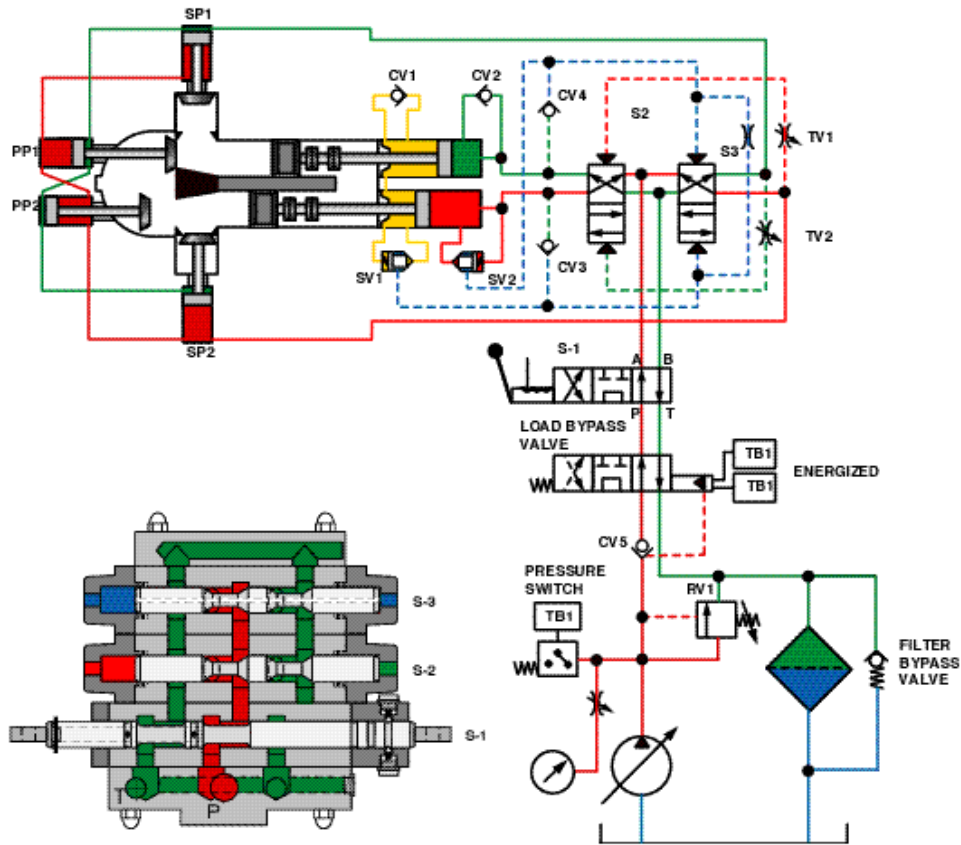



# Cincinnati MSD 8" Sludge to Incinerator





# Avon Lake – 30" Carbon Steel Pipe Drinking Water

- Pipe size: 30" Carbon Steel
- Dual Path Meter Utilizing M-Sized Transducers in Reflect Mode, Providing 4 Paths of Measurement







## Cleveland VAMC – 10” and 8” Cast Iron City Water

- Pipe size: 10” and 8”
- Pipe Material: Cast Iron
- Installed in Metering Pit
- Dual Path Meter Utilizing IP68 (Submersible) Transducers with PermaLok
- 4 Paths of fluid measurement





## Ohio Pump Stations – 4”, 6”, 8” Raw Sewage

- Pipe size: 4”, 6” 8”
- Pipe Material: Concrete Lined Ductile Iron
- Single Channel meters Utilizing “M-Sized” Transducers Installed in Reflect Mode
- 2 Paths of Measurement





# Overcoming Short Straight Run – NEORSD - Westerly

- Recommended Straight Run: 10 Diameters Upstream / 5 Diameters Downstream
- < 1 Foot available
- Pipe Tested with F601 Portable Meter Which Provided Valuable Results
- Successfully Installed 6 Permanent Meters on Pump Discharge

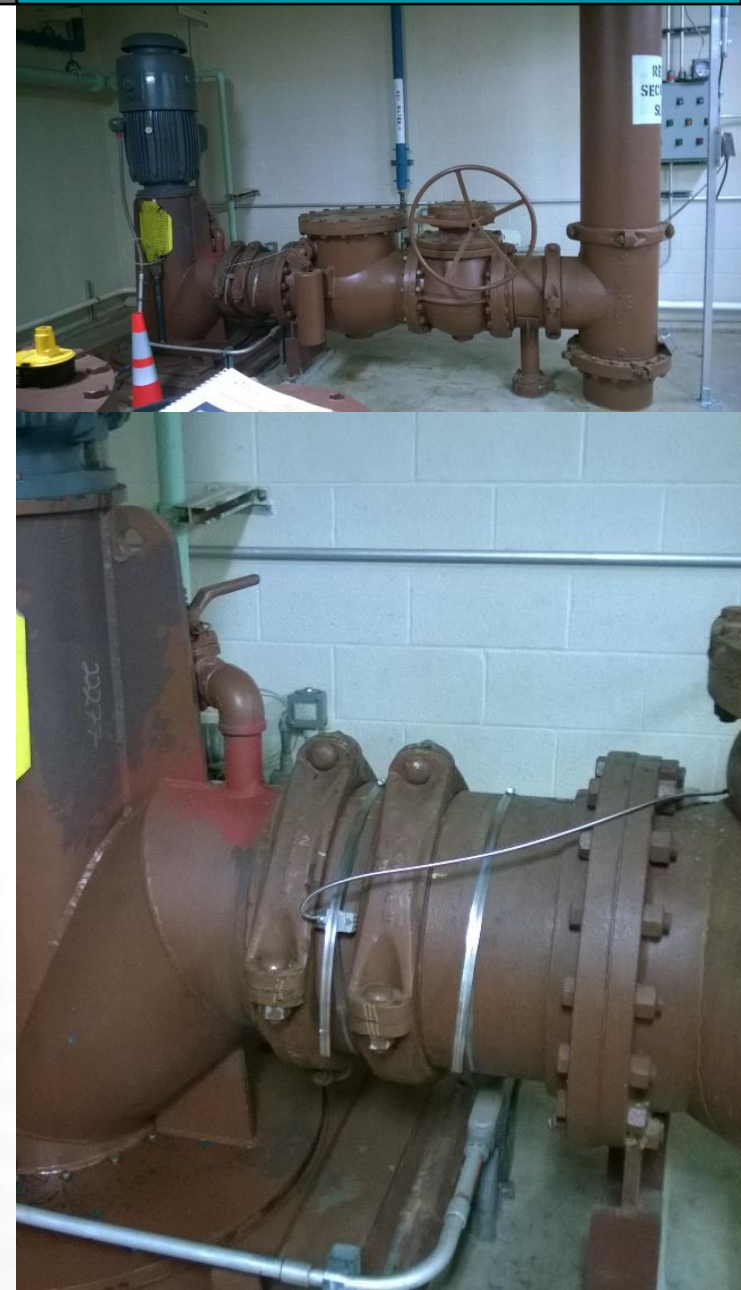



# Overcoming Short Straight Run – City of Pataskala Water Plant

- Recommended Straight Run: 10 Diameters Upstream / 5 Diameters Downstream
- 1 Foot available
- Pipe Tested with F601 Portable Meter Which Provided Valuable Results
- Successfully Installed 2 Permanent Meters on Pump Discharge





# FLUXUS Product line





# Permanent Flow Meter – FLUXUS ADM 7404

- Highly Customizable with a Wide Range of Individual Electrical Inputs & Outputs
- HART, BACnet, Modbus, and Ethernet Digital Communication
- FM Class I, Div. II Versions Available
- Optional 316 SS Enclosure for Corrosive Environments





## Permanent Flow Meter – FLUXUS ADM 8027

- FM Class 1, Div 1 Approved Flow Meter for Direct use in Hazardous Areas
- Explosion-Proof Housing with Optional Intrinsically Safe Outputs
- Inherits all of the features the FLUXUS ADM 7407 offers (intrinsically safe version available)

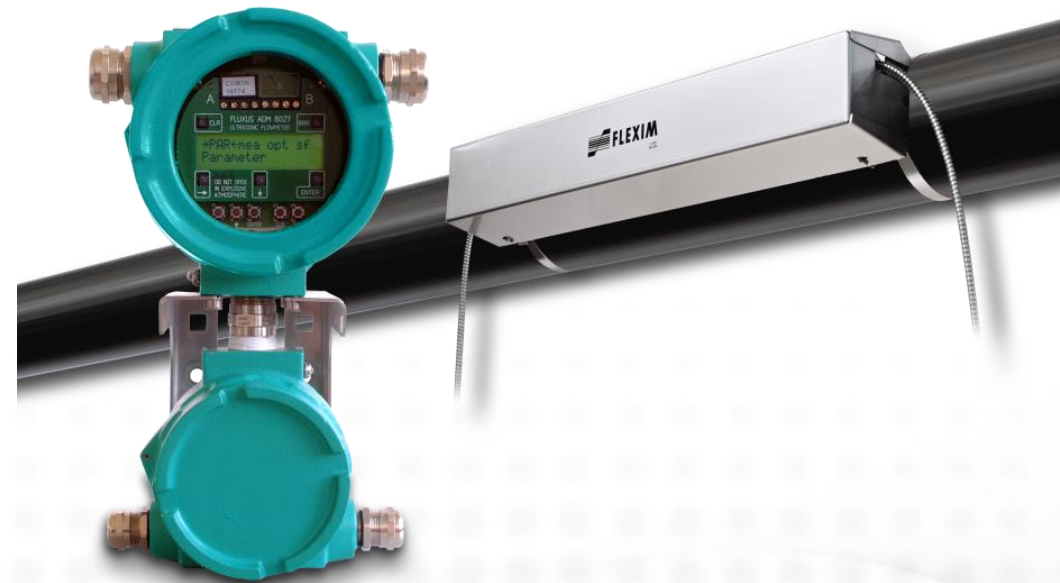



# Portable Flow Meter – FLUXUS F601

- Lightweight, ergonomic and highly intuitive portable flow meter and thermal energy meter
- Accurate measurement results in less than 5 minutes
- Sturdy housing designed for industrial environments with fully protected cable glands
- Over 14hrs of remote measurement







**The Result: Flexim is a Maintenance Free  
Permanent Solution**



*CHALTRON*  
*SYSTEMS, INC.*

**Thank you**