



INVICTA ADVANCED RUBBER COMPONENTS



Our History

Founded by Mr. Gopal Chopra in 1995, Invicta is a family business that has grown from its humble beginnings of 3 employees and 200 sq ft of space to an organisation employing a little over 400 people and 200,000 sq ft of manufacturing space across 4 locations in India.



Having a rich manufacturing experience that spans over 23 years, Invicta caters to the automotive, industrial, power T&D and commercial equipment manufacturing industries as well as other manufacturers through its various products such as rubber parts, rubber bonded parts (engine mounts, rubber bushes etc.), high voltage polymer insulators, mechanical control cables, metal turned parts, sheet metal components, plastic injection moulded parts and rubber tooling.

Being a family run business, Invicta values its relationships with customers, suppliers and employees alike. With an average customer age of 20 years, employees who have been with Invicta for up to 18 years (and counting!) and suppliers who have built their business (and families) working with Invicta for over 20 years all go a long way in establishing Invicta as a reliable and trust-worthy business partner.

Manufacturing Capability

Having multiple product groups means having a varied and flexible manufacturing operation that allows for an efficient and effective deployment across product groups and manufacturing locations. Right from rubber compounding, sheet metal fabrication, an in-house phosphating and ultrasonic cleaning line to our moulding and hydraulic mount and bush assembly lines, Cable assembly lines and insulator manufacturing cells, our processes are well developed and constantly evolving to provide consistent and reliable products and services to our customers.

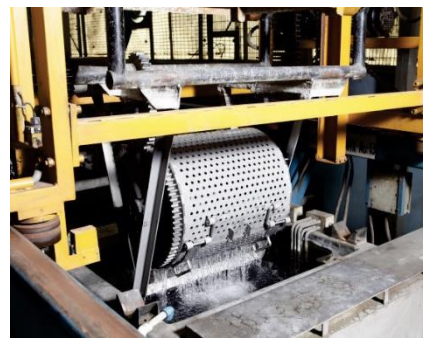

ABOUT INVICTA RUBBERTECH COMPONENTS

At INVICTAINDIA, we produce superior quality rubber products to satisfy your volume and customization needs. Our tradition has been to keep our turnaround time shortest in industry to make us your reliable rubber manufacturing partner. Our engineers keep a check of the specified quality through tolerances around dimensions and on desired properties of finished products to deliver them on time. With years of expertise in natural and synthetic elastomer compounds, we manufacture rubber gaskets, seals, o-rings, hoses, grommets, bellows, plugs, and caps from EPDM, Silicone, Fluorosilicone, FKM (Viton), NBR (Nitrile, Buna-N), HNBR, Neoprene, SBR etc to just name a few. Our experienced engineers are involved throughout the process of rubber product ideation, material suitability analysis, product design, die design, rubber compounding, color matching, prototyping, manufacturing, post production fabrication, and product quality testing to ensure that we always deliver high quality molded and extruded rubber products to our customers expectations. We are proud to be one of the very few rubber manufacturers here in INDIA that provide standard as well as custom size, shape, color, and compound options with extruded and molded rubber components. We are always on board to make suggestions regarding the compounds and properties which would best fit your technical, mechanical, electrical, and chemical properties requirements. We optimize each product related manufacturing process for best quality rubber components for your worry free operations. For us, customer satisfaction is the ultimate goal. Reach out to us for a quick quote or guidance on your project needs around rubber seals, gaskets, o-rings, diaphragms, sleeves, extruded strips, cords, or profiles.

Invicta Rubbertech (a division of Rex Consolidated) is a premier manufacturer and global supplier of high-performance engineered rubber solutions. With decades of expertise in elastomer technology, we specialize in delivering precision-molded and extruded components that meet the rigorous standards of **OEMs** and **aftermarket** customers across the automotive, industrial, defense, and energy sectors. Headquartered in **Faridabad, India**, our state-of-the-art manufacturing facility is driven by a commitment to durability, technical innovation, and uncompromising quality. We leverage advanced materials—including EPDM, Silicone, Viton (FKM), Nitrile (NBR), and Neoprene—to ensure our components perform consistently under extreme temperatures and demanding environmental conditions.

Our Core Product Portfolio

We take pride in a diverse range of engineered products designed for vibration isolation, fluid sealing, and mechanical protection:

- **Rubber Mountings (Engine):** High-strength rubber-to-metal bonded solutions engineered for optimal vibration damping and engine stability.
- **Bushes & Silent Blocks:** Precision-engineered bushings designed to reduce friction and absorb radial/axial shocks in suspension and industrial machinery.
- **Rubber Grommets & Plugs:** Essential protection for wire insulation and hole sealing, available in standard and custom configurations.
- **Rubber Seals & O-Rings:** High-tolerance sealing solutions designed for leak-proof performance in hydraulic and pneumatic systems.
- **Rubber Bellows & Boots:** Flexible, durable covers that protect moving parts from dust, moisture, and contaminants.
- **Rubber Buffers & Stoppers:** Impact-resistant components used to limit travel and protect equipment from mechanical damage.
- **Rubber Extruded Components:** Custom profiles including "U," "D," and hollow shapes for door seals, gaskets, and specialized industrial applications.
- **Rubber Washers & Spacers:** Versatile components providing tight seals and precise spacing in mechanical assemblies.
- **Pads & Anti-Vibration Sheets:** Specialized sheeting designed for heavy-duty machinery foundations to mitigate structural noise and oscillation.



The Invicta Advantage: Why Global Industries Trust Us

- **In-House Design & Prototyping:** From material suitability analysis to die design and prototyping, our engineers partner with you at every stage.
- **Quality Assurance:** Every component undergoes strict testing for elongation strength, abrasion resistance, and durability, ensuring compliance with global standards.
- **Custom Engineering:** We provide tailored solutions, offering various compounds, colors, and shapes to meet your unique specifications.
- **Sustainability Mindset:** We are dedicated to eco-conscious manufacturing, optimizing energy consumption and reducing waste across our production lines.

At **Invicta Rubbertech**, we don't just manufacture parts; we build reliability. Our goal is to keep your machines running smoother, your vehicles safer, and your operations more efficient.



APPLICATIONS



Advanced Materials & Testing

We use high-grade rubber compounds and advanced formulations, supported by strict testing protocols, to ensure every component delivers durability, flexibility, and performance under extreme conditions.



Proven OEM & Aftermarket Supply

Our products are trusted by leading OEMs as well as aftermarket customers, backed by years of reliable supply, strong partnerships, and consistent quality across large-volume and custom orders.



Custom Engineering Capabilities

With in-house design expertise and flexible manufacturing, we provide tailored rubber solutions that meet unique specifications and solve complex challenges for diverse industries.



Consistent Quality & On-Time Delivery

From production to logistics, our processes are built around precision and reliability, ensuring every part meets standards and reaches customers on schedule, without compromise.

Sustainable & Quality Commitments

At Invicta RubberTech, we believe that true progress combines innovation with responsibility. Our sustainability practices are designed to reduce environmental impact while ensuring long-lasting performance in every product we deliver. From using eco-conscious materials and reducing waste in production to optimizing energy consumption, we are committed to building solutions that support a greener tomorrow.

Quality is at the core of our operations and defines how we work every day. Every hose, seal, gasket, and mounting is manufactured under strict quality control systems that meet global standards. Our testing protocols cover durability, flexibility, and resistance under extreme conditions, ensuring that each component performs consistently in the most demanding environments.

By combining sustainability with uncompromising quality, we deliver value that extends beyond products. Our customers gain not only reliable rubber solutions but also the assurance of working with a partner dedicated to continuous improvement, ethical manufacturing, and long-term industry leadership. At Invicta RubberTech, protecting the planet and protecting your performance go hand in hand.



OUR MATERIALS

1. EPDM (-55° C to 150° C)
2. NATURAL (-40° C to 108° C)
3. NEOPRENE (-40° C to 120° C)
4. NITRILE (-30° C to 100° C)
5. POLYURETHANE (-30° C to 80° C)
6. PTFE (-71° C to 260° C)
7. SILICONE (-20° C to 204° C)
8. SPONGE & FOAM
9. TPE
10. VITON
11. FLUOROSILICONE (-70° C to 175° C)
12. HYDROGENATED NITRILE RUBBER (-40° C to 150° C)
13. CARBOXYLATED NITRILE RUBBER (-30° C to 100° C)
14. STYRENE BUTADIENE RUBBER (-40° C to 105° C)
15. PERFLUOROELASTOMER (-40° C to 120° C)

APPLICATION

- 1. AEROSPACE**
- 2. AUTOMOTIVE**
- 3. OIL & GAS INDUSTRIES**
- 4. DEFENSE**
- 5. PHARMACEUTICAL**
- 6. RENEWABLE ENERGY**
- 7. FOOD & DAIRY**
- 8. AGRICULTURE**
- 9. MARINE**
- 10. RAILWAYS**
- 11. GENERAL INDUSTRIES**

BELLOWS

Rubber bellows are used to sealing environments, carrying liquids, slurry and gases, mechanical coupling, and performing electrical contact amongst other things. These bellows are durable and flexible. These bellows are type of cylindrical vessels which are readily compressible and extensible due to various annular convolutions. Rubber bellows are available in a wide variety of shapes, sizes, constructions and elastomer coated fabrics or rubbers to fit any specific applications needs.



CUSTOM EXTRUDED COMPONENTS

INVICTA produces a wide range of custom extruded products such as gaskets, door seals, and spliced rings in different shapes as well as sizes. We can extrude "U", solid "D", hollow "D", and custom shapes from both dense and sponge materials. For special application requirements, we also offer PSA-backed, vulcanized, and spliced custom extrusions. Employing salt bath and microwave curing allows us to meet the tough quality standards for organic and silicone rubber. We produce parts to stringent FDA, Mil-Spec, and RMA (Rubber Manufacturers Association) standards.



RUBBER BUMPER

We manufacture custom rubber bumpers, tips and appliance feet using commercial grades of SBR, as well as Neoprene® 1, EPDM, nitrile, and silicone., including high-temperature silicone bumpers. Materials are available in commercial and specification grades including: NASM, ASTM, AMS, SAE and others.

At Minor Rubber, we have earned the reputation for manufacturing high quality rubber parts. Our attention to detail and commitment to excellence for every project, coupled with our experience and knowledge of the industries we serve, ensure that your rubber bumpers, tips and appliance feet will meet or exceed your expectations. Minor Rubber offers an extensive inventory of high quality bumpers, tips and appliance feet in various sizes and shapes for industrial use. In addition, we have the capability to manufacture a custom part to meet your specific application requirements.

Our industrial rubber bumpers, tips and feet are used in a wide range of applications, including electronics, aerospace, healthcare, construction, transportation, and defence applications.



SILENT BLOCK BUSH

Our company is widely acknowledged as one of the leading manufacturers, exporters and suppliers engaged in offering premium quality Silent Block Bushes. Best of engineering technologies and production techniques are employed to fabricate our Rubber Silent Block Bushes, Silent block Bushes, Automotive Silent Block Bushes, and Silent Block Rubber Bushes.

Types of Silent Block Bushes:

- Cylindrical Type Silent Block Bushes
- Collar Type Silent Block Bushes
- Flange Type Silent Block Bushes



RUBBER TENSIONERS

When the season is over, it's time to make sure your boat is safe for the winter. We offer a wide range of rubber tensioners and accessories for boat covers.

Our tensioning straps are made of weather and ageing resistant black or white EPDM rubber that doesn't mis-colour, and natural rubber with high elasticity.



RUBBER FLANGE

We manufacture a wide range of Rubber Flanges that is extensively demanded by our clients for their durability and economical pricing. These are manufactured using optimal quality material procured from reliable sources. Designed under the vigilance of our diligent technocrats, our range is robust in construction and utilized for suction and discharge of sand and water at high pressures.

By following industrial quality standards, we are highly dedicated towards providing a supreme quality gamut of Rubber Flanges.



ANTI SHOK PAD

Leveraging over the skills of our qualified team of professionals, we are instrumental in offering wide range of Anti Vibration Pads. These Products can be used for industrial as well as for domestic purpose also. These anti vibration pads is made from top quality range of rubber and cork materials that are efficiently designed and fabricated to achieve excellent strength and toughness. Anti Vibration Pad is long lasting cheap in price and its use to avoid vibration. Its weather proof, elastic high tensile property.



O-RING

O-Rings offer the designer an efficient and economical sealing element for a wide range of static or dynamic applications. Inexpensive production methods and its ease of use have made the O-Ring the most widely used seal. A wide choice of elastomer materials for both standard and special applications allow the O-Ring to be used to seal practically all liquid and gaseous media. O-Rings are vulcanised in moulds and are characterised by their circular form with annular cross section.



RUBBER WASHER

Rubber washer is defined as a thin disk made of rubber with a hole in the middle. The washer is normally used to support the weight of a threaded fastener. It is also used as a spacer, spring, wear pad, pre-load indicating device as well as locking device. Washers are made of various materials like metal, plastic, rubber. A common material is rubber. Rubber washers are used in taps or valves where they act as the seal that prevents or closes the flow of liquid or gas. All washers including rubber washers have an outer diameter (OD) about twice their inside diameter (ID). Rubber gaskets which are used in taps to stop the flow of water are also sometimes referred to as washers because they look similar. But, washers and gaskets are usually made differently and designed for different functions.



RUBBER SHEETS

INVICTA INDIA Rubber sheets are available in various lengths and widths. These sheets are cut according to customer requirements. Various types of rubber are used to make sheets. These sheets are very popular and used in an extensive range applications. There are a comprehensive range of rubber sheets for general, industrial and Invicta India applications. These sheets are also available in vulcanized black as well as colored sheets for technical uses and industrial applications. There can also be smooth surfaced rubber sheets or with a canvas-type print on one or both sides of the rubber sheets. These sheets insertions are usually designed for use in applications where stresses are generally static and pressures are low. There can be cloth insertion, metal mesh insertion, gauze, nylon cloth, and copper insertion.

Measurement of thickness of sheets

Rubber sheets are difficult to gauge with conventional thickness measurement techniques. However, with ultrasonic thickness gauges, any point on the entire surface, not just the edges alone, of a rubber sheet can be measured without ever having to contact the opposite side. Ultrasound waves travel through the sheets and reflect from the acoustic interface of the rubber and the substrate. It is important to know the exact nature of the application of the sheets on certain materials and also may require special setups in order to maintain accuracy of thickness readings. Ultrasonic thickness measurements on rubber can be done manually as well as semi-automatically.



AUTOMATIVE BELT

Made to original equipment specifications, high quality cogged auto belts from INVICTA INDIA provide up to 3 times more service life than normal wrapped belts. Durable fibre chip rubber compound is used in these belts to provide high friction co-efficiency, excellent resistance to wear and flexibility. The unique cog design of the belt results in longer flex life over small and high speed. Impregnated with heat and oil resistant rubber compounds, these belts are highly flexible, corrosion and abrasion resistant. Cogged belts from InvictaIndia are applicable for most 2 wheelers, 3 wheelers, Passenger Cars, Multi utility vehicles (MUV), Commercial Vehicles and Tractors and other off-highway applications.



GROMMET

We have available with us a wide array of Industrial Rubber Grommets. For reinforcing the hole and covering from the sharp edges of the hole, these grommets are used. These grommets are precise in sizes, dimensions and finish. We can make these grommets in custom sizes & shapes too.

Features:Reliable

Ductile

Durable



DIAPHRAGMS

For more than 6 years INVICTA INDIA has begun with the manufacturing of rubber diaphragms. Since then the company has been developing as leading supplier and solution finder of individual requirements for all range of diaphragms: punched, moulded, with or without texture and thermoformed. Development partner for the diaphragm and its environment. Specific material development for high temperature. Competence centre to guarantee our customers state of the art development of diaphragms. High performing equipments (hysteresis, test bench...) Mastery of our production process that guarantees a great quality stability



RUBBER MAT



MUD FLAPS

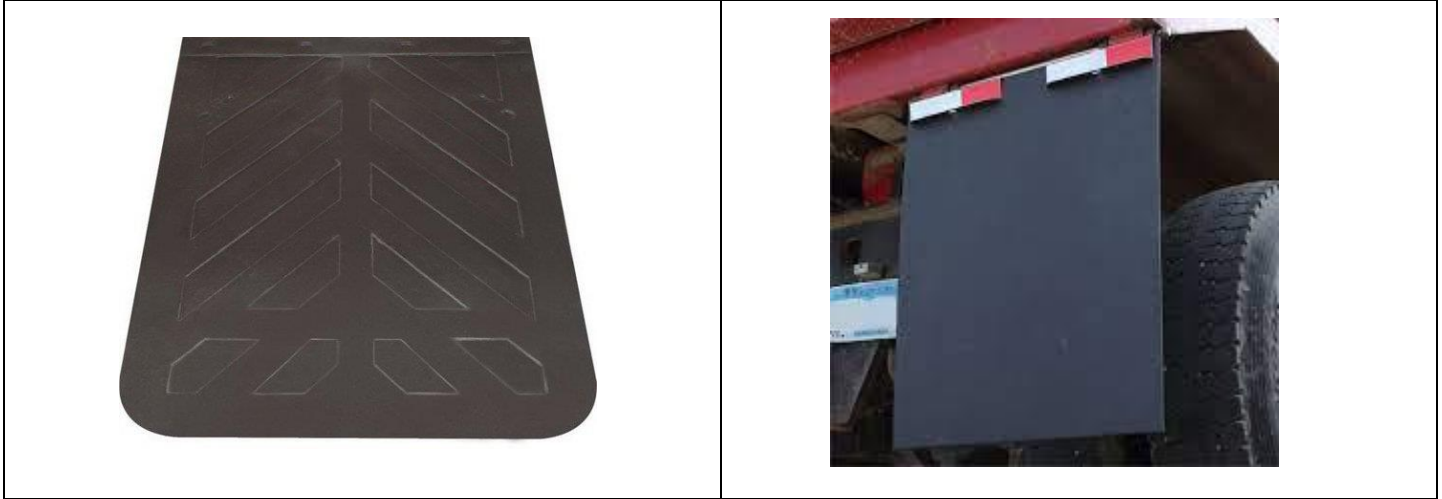

POLYMER INSULATORS

We manufacture strain insulators, tension insulators, dead-end insulators, F-Neck (Pin) Insulators, Drop-Out Fuse insulators, Sub-station post insulators and surge arrestors. Our products range from 11kV to 400kV.

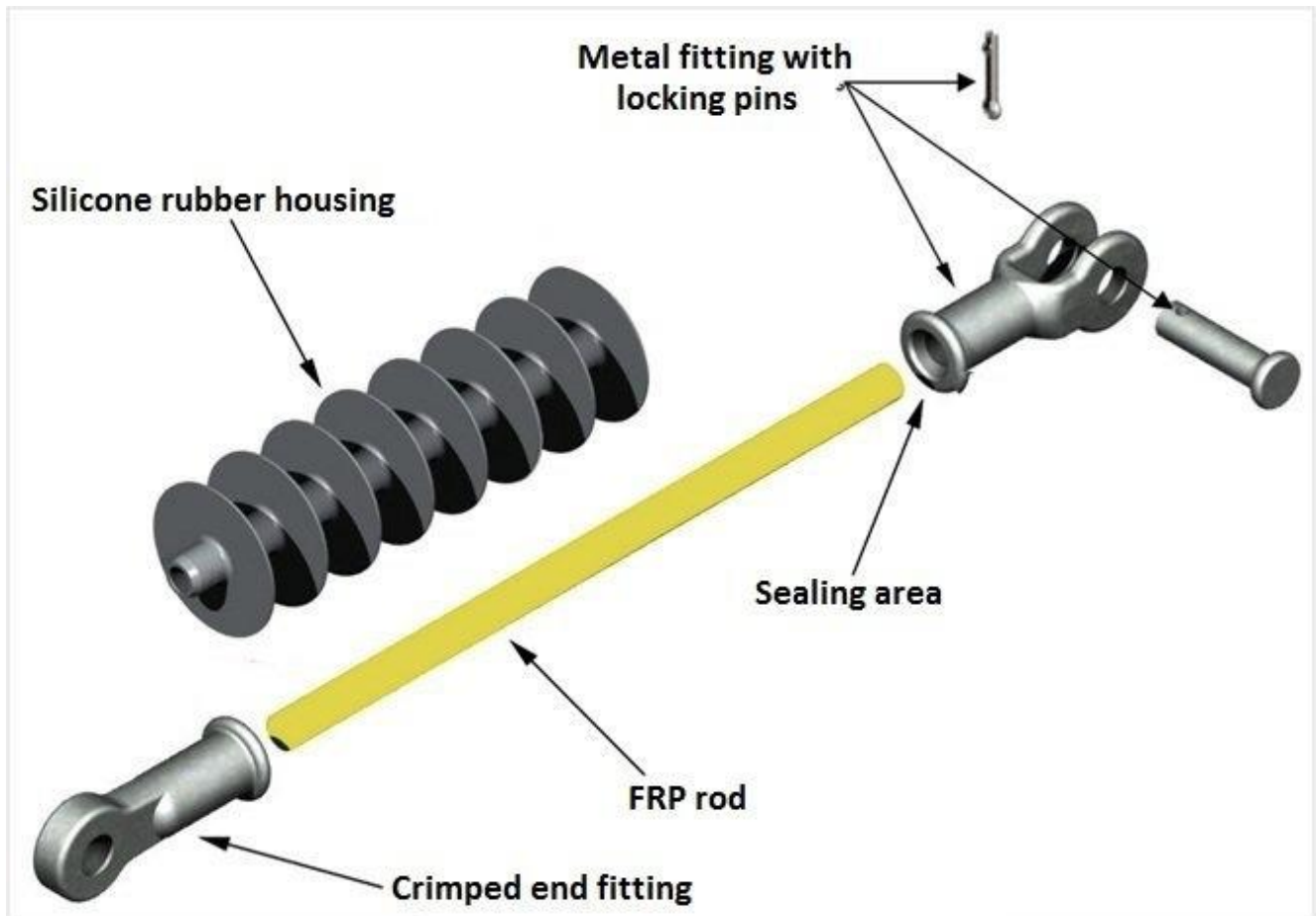













TYRE RECLAIM



CI Solid Rubber Trolley wheel

Invicta India , we are a leading manufacturer and supplier of trolley wheels. Our trolley wheels are designed to provide smooth and easy movement, making them ideal for a variety of applications. Whether you need trolley wheels for a commercial or industrial setting, we have the perfect solution for you

 <ul style="list-style-type: none"> • Size 16*4", • Size mm- 400 mm* 100 mm • Bearing size: 6308 	 <ul style="list-style-type: none"> • Size 14*4" • Size mm - 350 mm*100 mm • Bearing size: 6307 	 <ul style="list-style-type: none"> • Size 14*4" • Size mm - 350 mm*100mm • Bearing size: 6307
 <ul style="list-style-type: none"> • Size 14*3" • Size mm- 350 mm * 75 mm • Bearing size: 6307 and 6205 	 <ul style="list-style-type: none"> • Size 14*3" • Size mm- 350 mm * 75 mm • Bearing size: 6307 and 6205 	 <ul style="list-style-type: none"> • Size 14*2.5" • Size mm- 350 mm * 62 mm • Bearing size: 6307 and 6205
 <ul style="list-style-type: none"> • Size 12*2" • Size mm- 300mm * 50mm • Bearing size: 6205 	 <ul style="list-style-type: none"> • Size 12*2" • Size mm- 300mm * 50mm • Bearing size: 6205 	 <ul style="list-style-type: none"> • Size 10*2" • Size mm- 250mm*50mm • Bearing size: 6205
 <ul style="list-style-type: none"> • Size 8*2" • Size mm- 200mm* 50mm • Bearing size: 6205 	 <ul style="list-style-type: none"> • Size 8*2" • Size mm- 200mm* 50mm • Bearing size: 6205 	 <ul style="list-style-type: none"> • Size 6*2" • Size mm- 150mm*50mm • Bearing size: 6205



- Size 12*2" 25 mm
- Size mm- 300mm*50mm
- Size 10*2" 25 mm
- Size mm- 250 mm* 50mm
- Size 08*2" 25 mm
- Size 200mm*50mm
- Size 06*2" 25 mm
- Size 150mm* 50mm



- Size 8*2" 25 mm
- Size mm- 200mm*50mm



- Size 6*2" 25 mm
- Size mm- 150mm *50mm

Rim Type Solid Rubber Trolley wheel



- Size 16*4",
- Size mm- 400 mm* 100 mm
- Bearing size: 6307



- Size 16*4",
- Size mm- 400 mm* 100 mm
- Bearing size: 6307



- Size 14*3",
- Size mm- 350 mm* 75 mm
- Bearing size: 6205



- Size 12*3.5",
- Size mm- 300 mm* 88 mm
- Bearing size: 6205



- Size 12*3.5",
- Size mm- 300 mm* 88 mm
- Bearing size: 6205



- Size 12*3",
- Size mm- 300 mm* 75 mm
- Bearing size: 6205



- Size 12*2",
- Size mm- 300 mm* 50 mm
- Bearing size: 6205



- Size 12*2",
- Size mm- 300 mm* 50 mm
- Bearing size: 6205

Tyre Type Coupling TC Series



Premium Coupling Series
TC -6,7,8,9,10,11,12,13,14,15,16 to 24



Flex Tyre Type Coupling TC Series



Premium Coupling Series
Flex - 40,45,50,60,70,80,85,90,,100,110,120,140 160

Diaphragm Coupling For Diesel Engines



Diaphragm Coupling For Diesel Engines

100mm, 105mm & 110mm

Anti Vibration Rubber Pad With Lining



Anti Vibration Pad with Lining

- Size : 6* 6 * 2", Size mm: 150mm*150mm* 50mm
- Size : 6*,6*1.5", Size mm: 150mm*150mm* 38mm
- Size:6*6* 1", Size mm:150mm*150*150mm*25mm
- Size: 6*6*0.5", Size mm: 150mm*150mm*12mm
- Size: 6*6*30MM, Size mm: 150mm*150mm*30mm

HUT Type Rubber Mounting-B



Hut Type Rubber Mounting B

- Heavy Duty- Weight 10kg
- Size: 6"

Furniture Rubber Cap



Size Available

- 50mm*50mm Square Cap
- 40mm*40mm Square Cap
- 25mm*25mm Square Cap
- 25mm*50mm Square Cap
- 20mm*40mm Square Cap
- 25mm*25mm Round Cap

Automobile Lift Rubber Pads



Two Post Lift Round Rubber Pad



Two Post Lift Rubber Pad

Size: 4*11" size mm: 100mm*275



Rubber Lift Pad

- Size: 10*6*55mm Thickness,
Size mm: 250*150*55mm
- Size: 6*4*3",
Size mm: 150mm*100mm*75mm
- Size: 6*4*1.5"
Size mm: 150*150*38mm

Sponge-dense-Steel core composite sealing

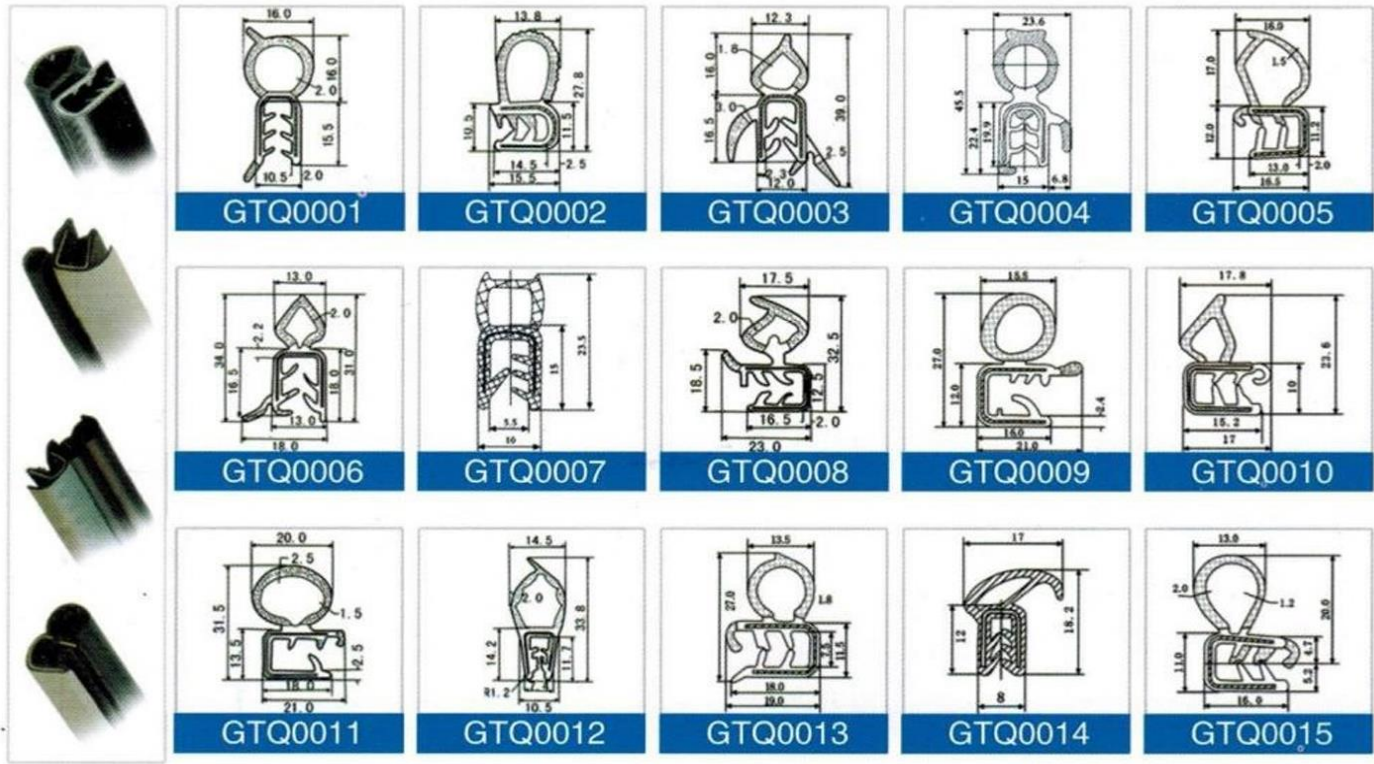

Composite Steel Skeleton Sealing Strip

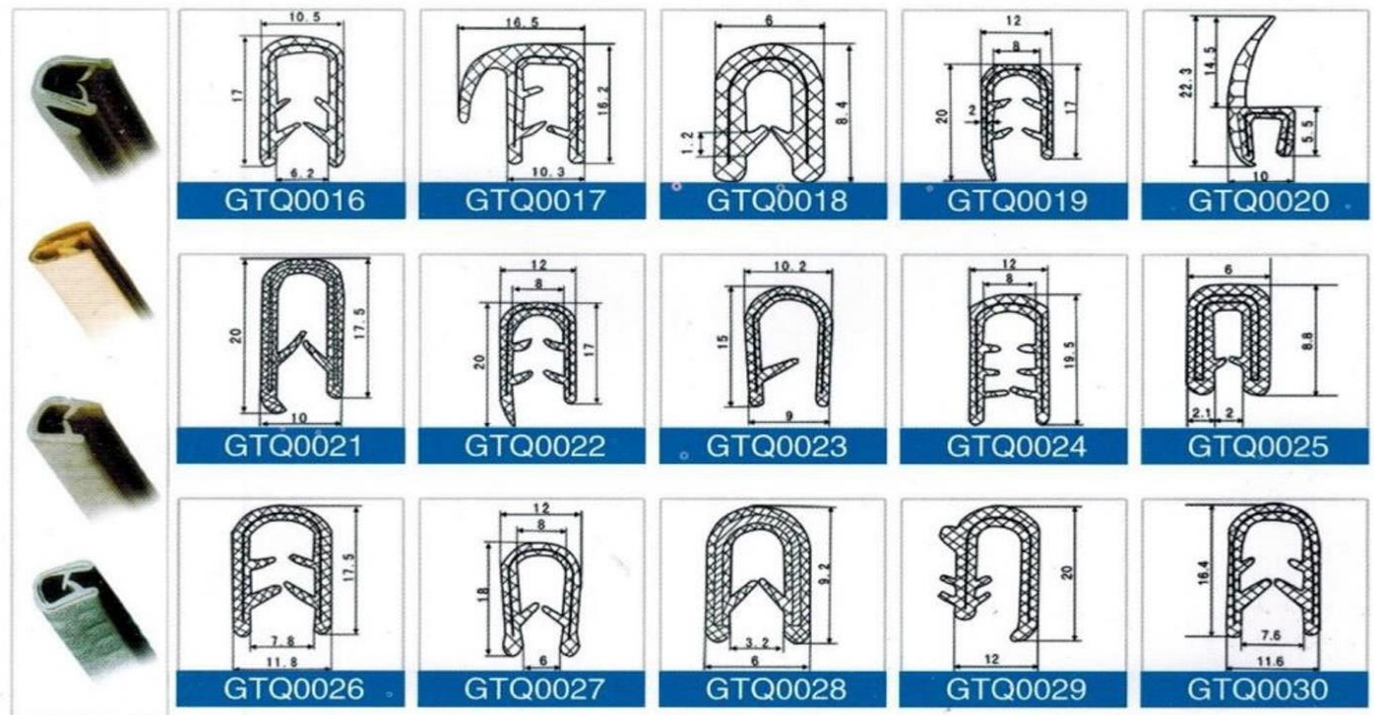

Dense Rubber Car Door & Window sealing strip

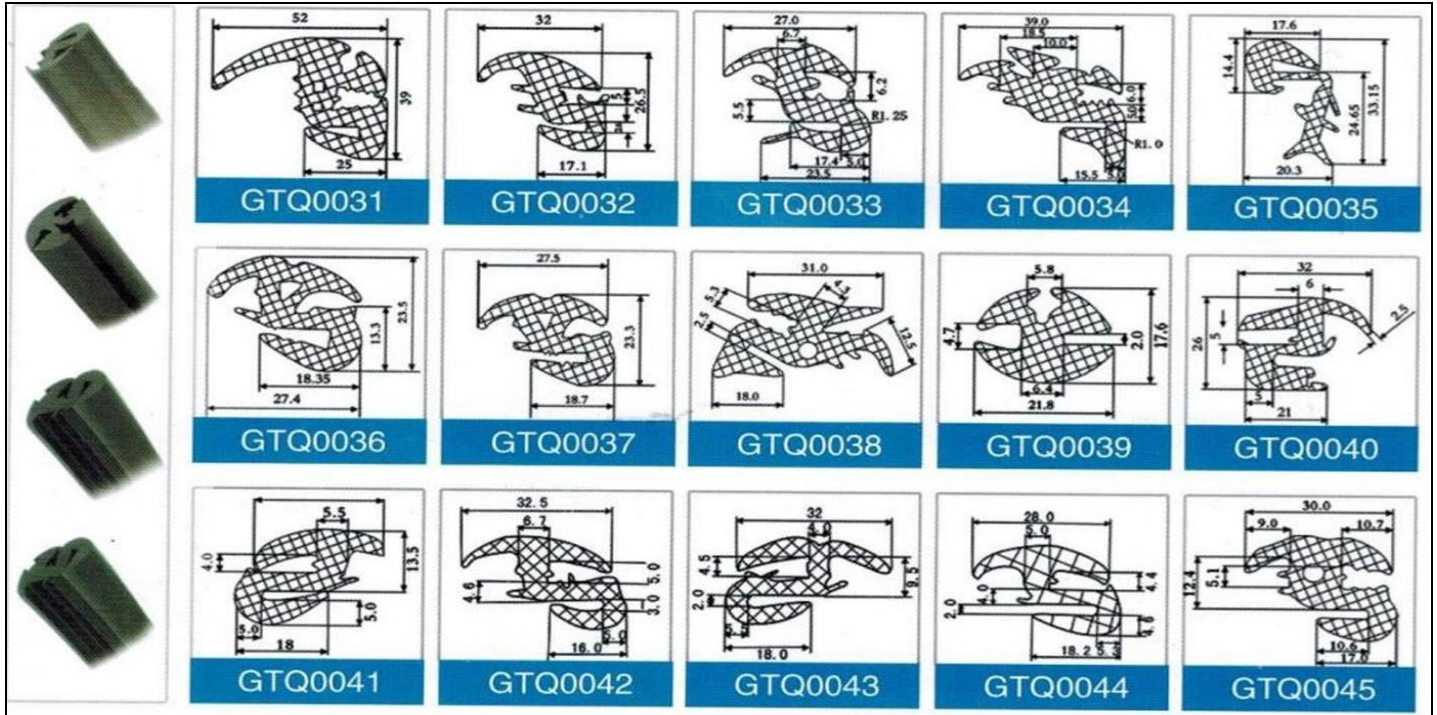

Sponge Rubber Car Door & Window Sealing Strip

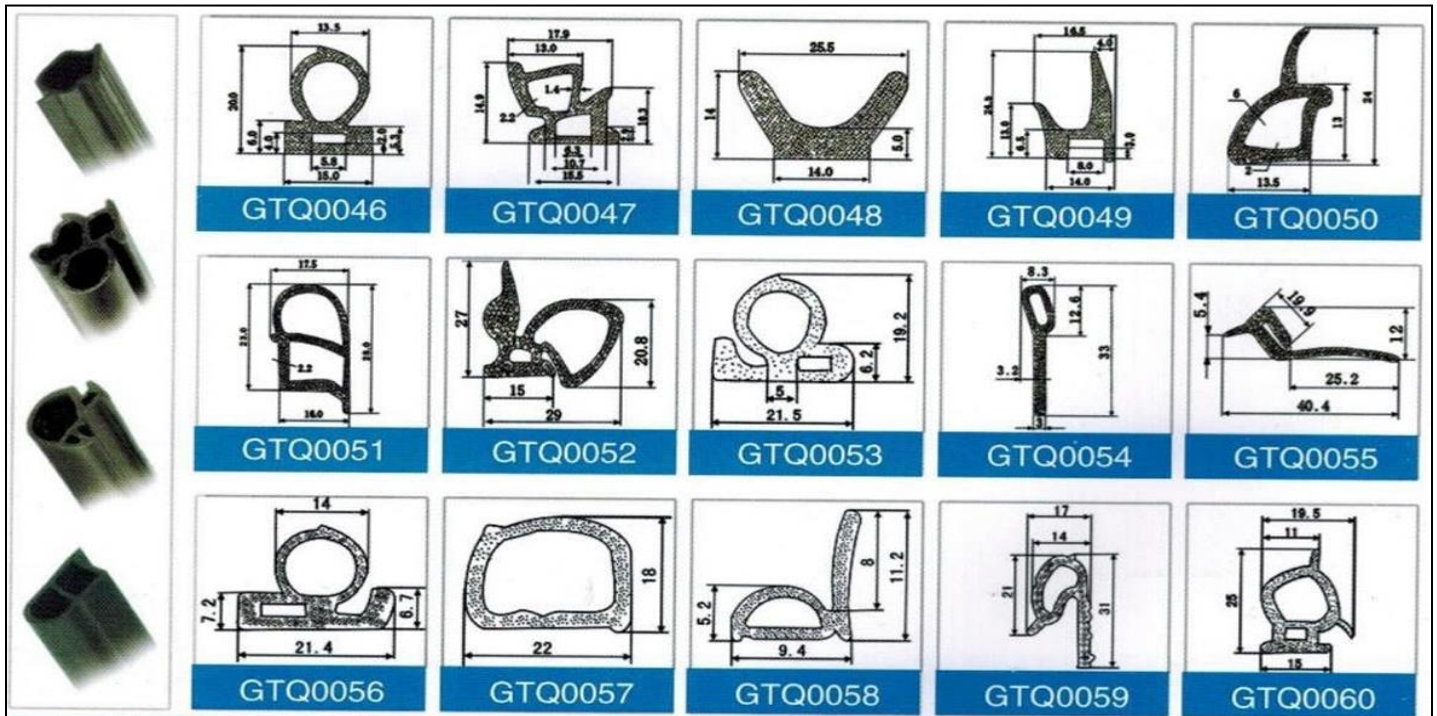

Glass Does Groove Seal Strip Cross Section

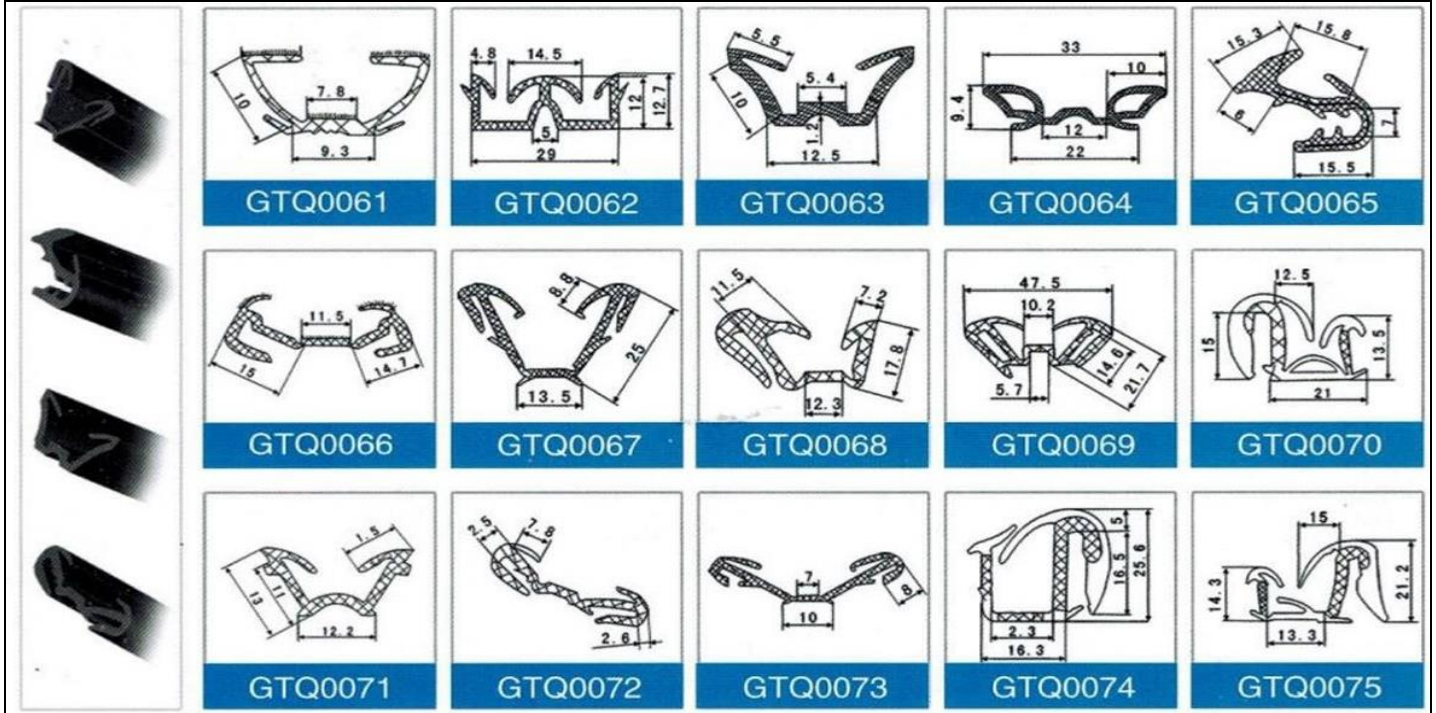

Car Water Cut Sealing Strip Cross Section

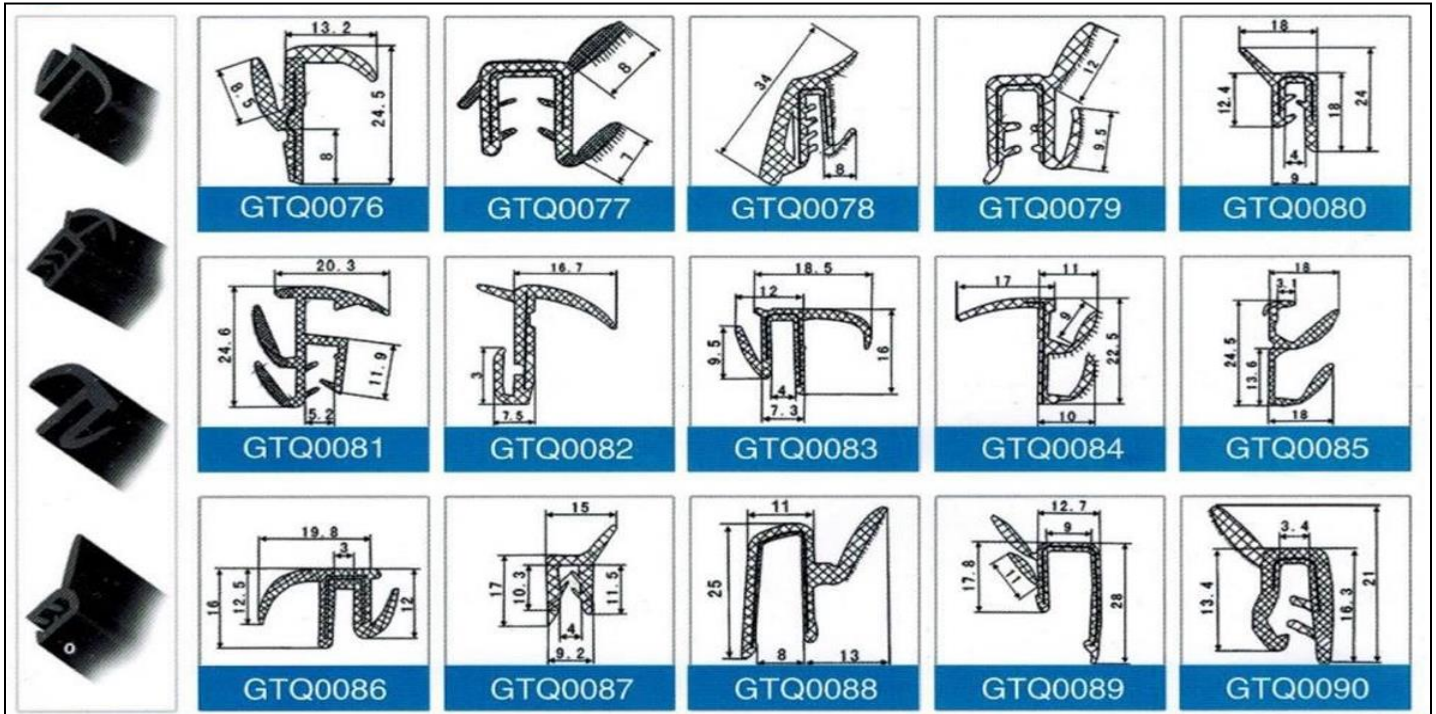

Door seal slot type, Self-Adhesive Series

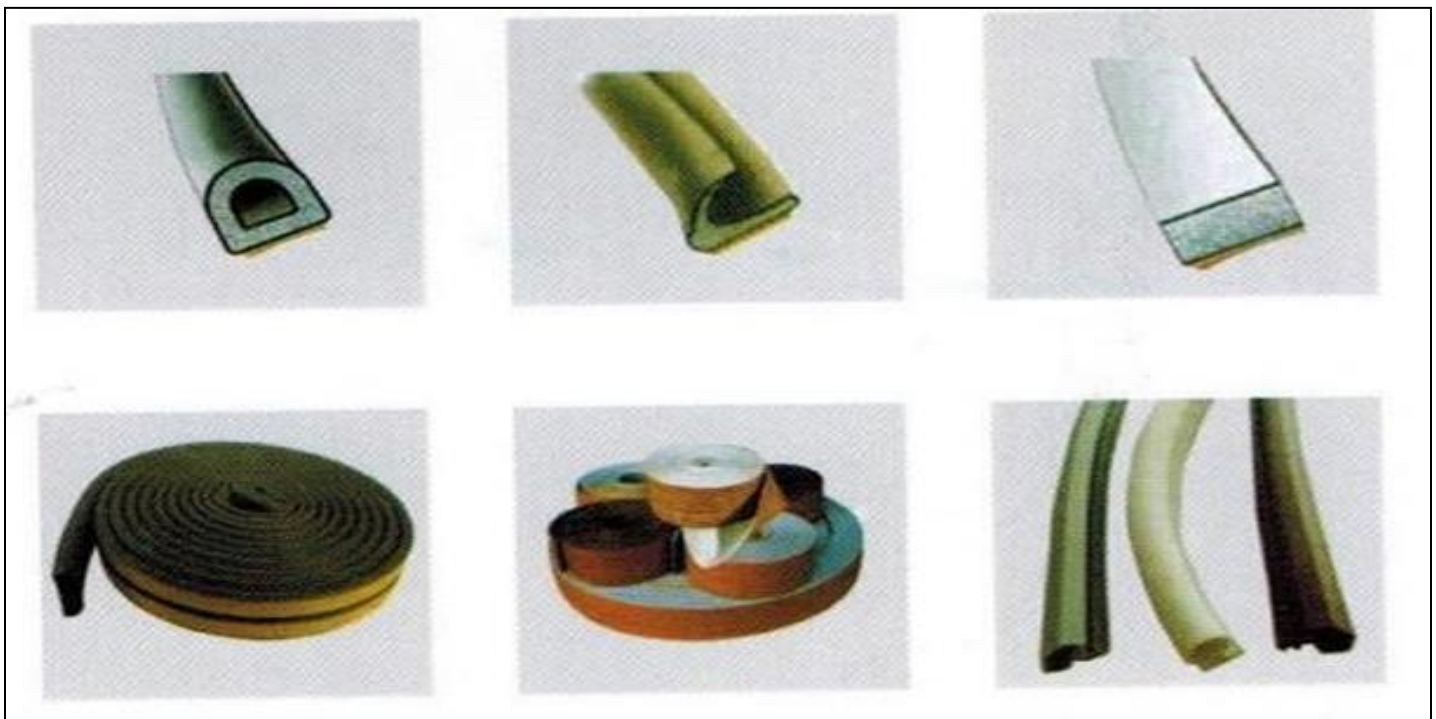

Foam Sealing Strip Series

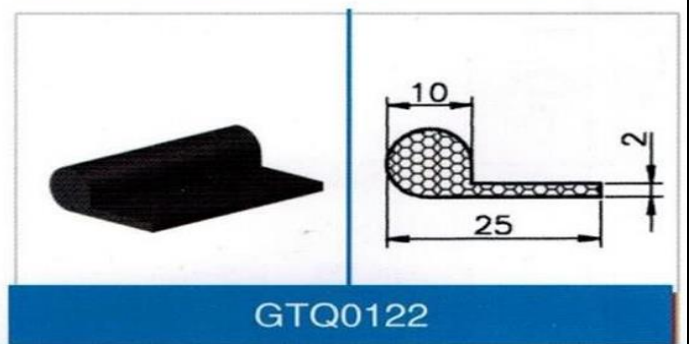
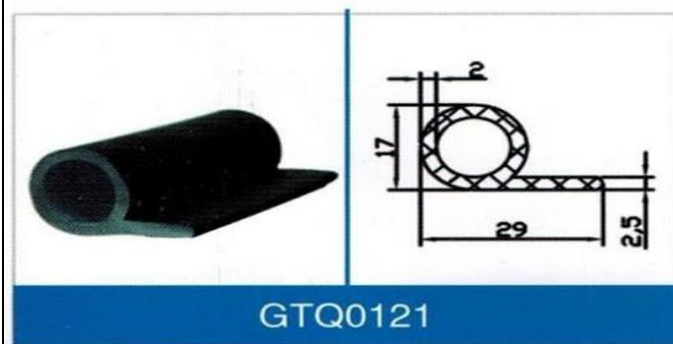
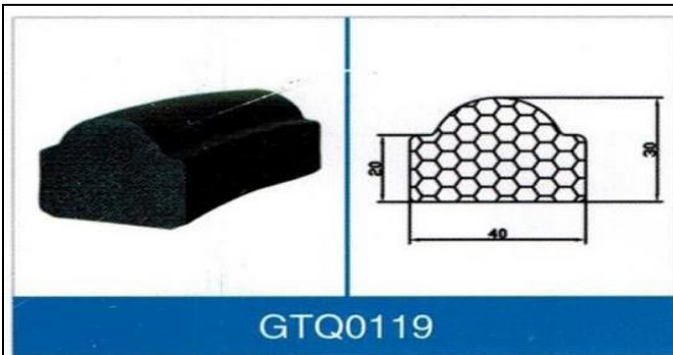
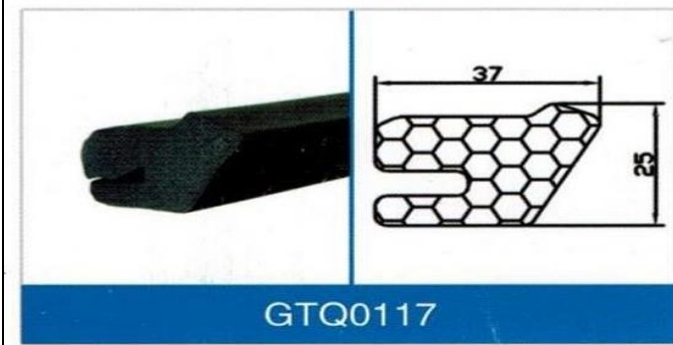
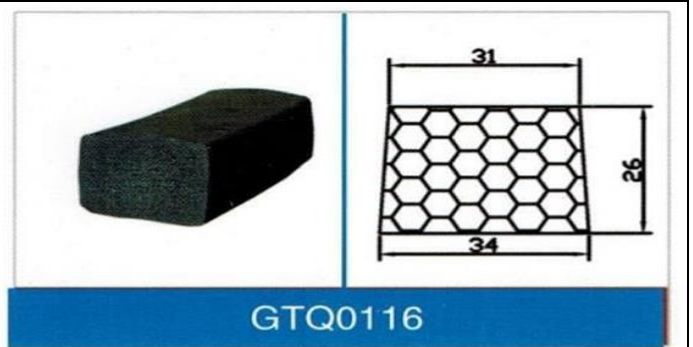
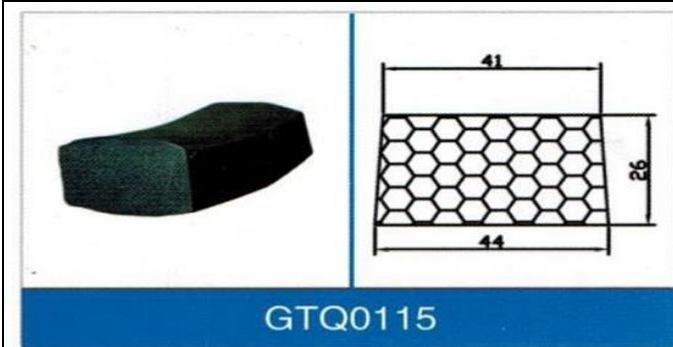

Dense Rubber Car Door & Window sealing strip

 <p>GTQ0123</p>	 <p>GTQ0124</p>	 <p>GTQ0125</p>	 <p>GTQ0126</p>
--	--	---	--

Cabinet Sealing Seal

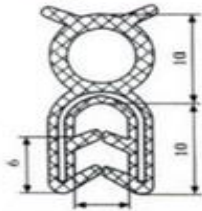

GTQ0127

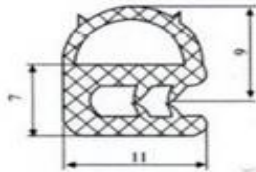

GTQ0128

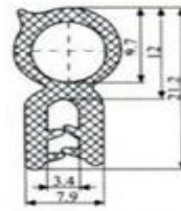

GTQ0129

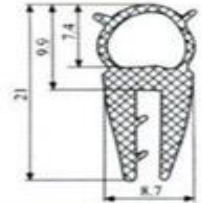

GTQ0130

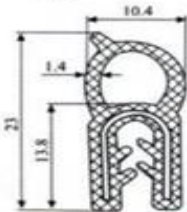

GTQ0131

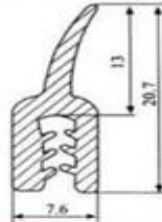

GTQ0132

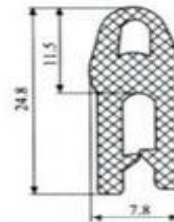

GTQ0133

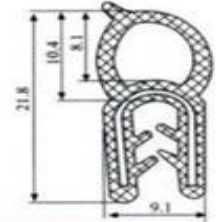

GTQ0134

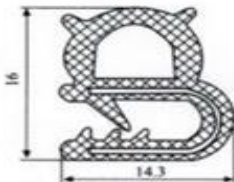

GTQ0135

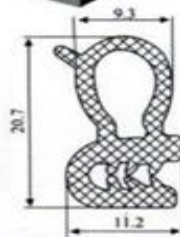

GTQ0136

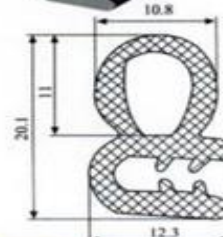

GTQ0137

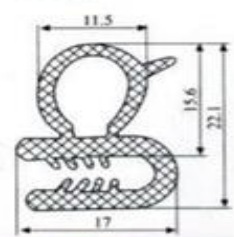

GTQ0138

Subway Train Sealing Strip



Electric Car Sealing Strip

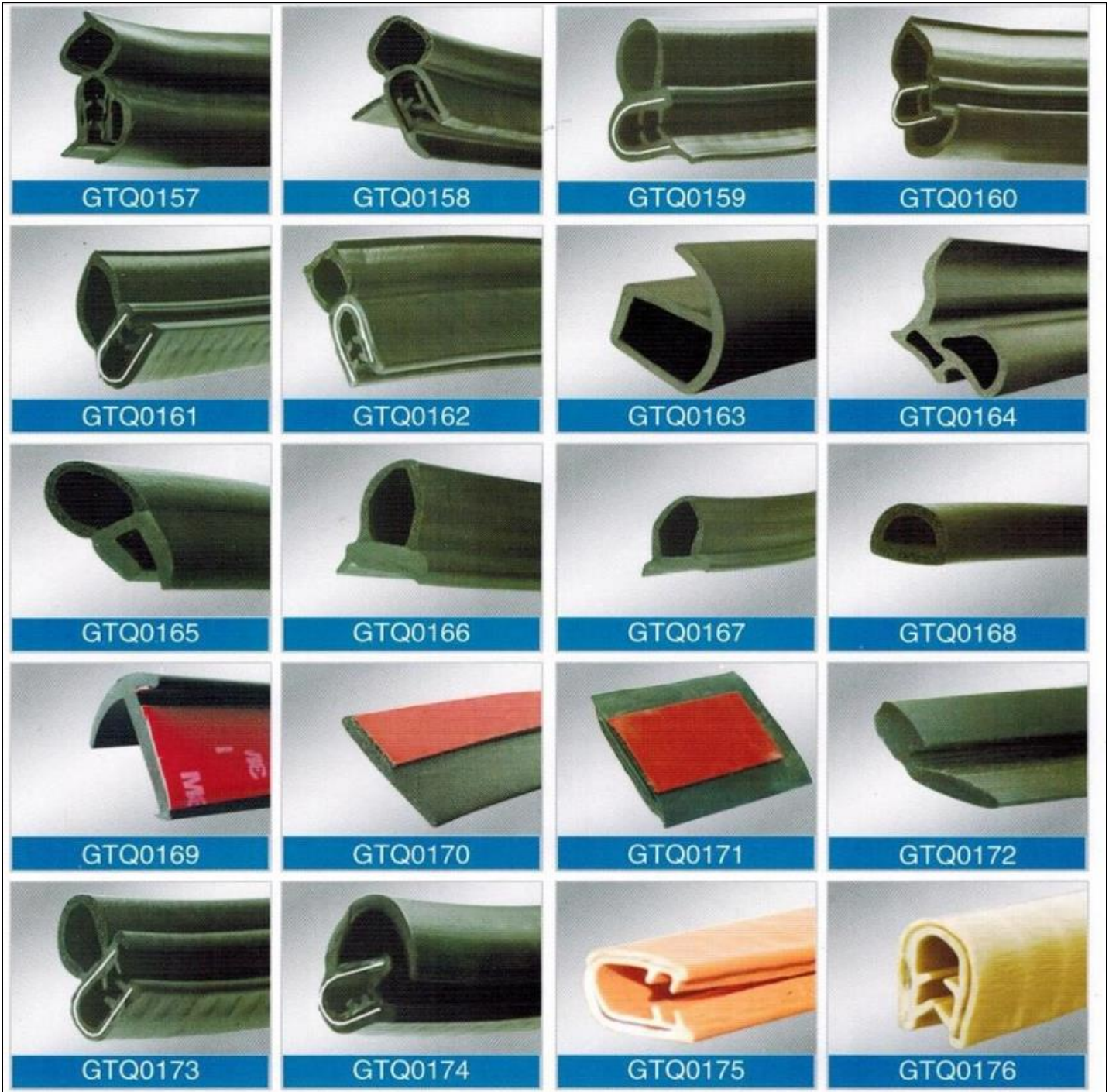

Silicone Rubber Seal



GTQ0300



GTQ0301



GTQ0302



GTQ0303



GTQ0304



GTQ0305



GTQ0306

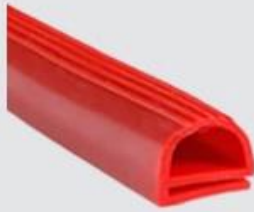

GTQ0307

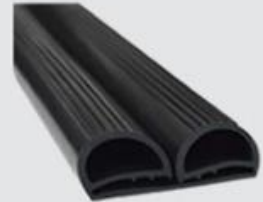

GTQ0308

Sealing Strip for photovoltaic Panels



GTF0001



GTF0002



GTF0003

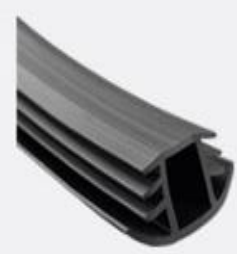

GTF0004

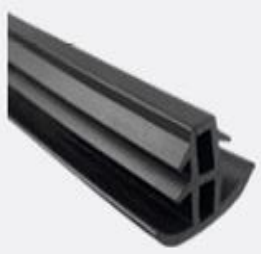

GTF0005

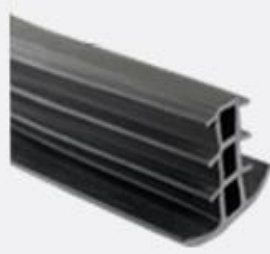

GTF0006

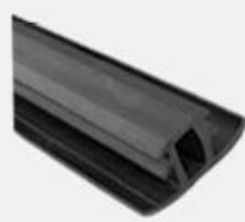

GTF0007



GTF0008

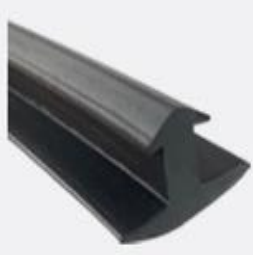

GTF0009

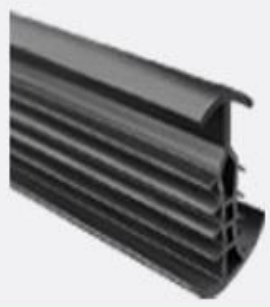

GTF0010

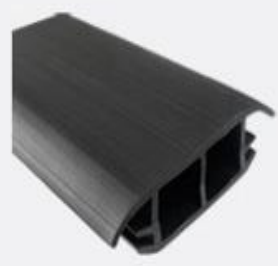

GTF0011

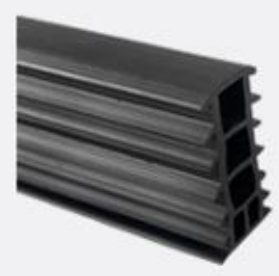

GTF0012

Sealing Strip for waste Dump Truck & Garbage Truck



Hose Products

			
GTJ0401	GTJ0402	GTJ0403	GTJ0404
			
GTJ0405	GTJ0406	GTJ0407	GTJ0408
			
GTJ0409	GTJ0410	GTJ0411	GTJ0412
			
GTJ0413	GTJ0414	GTJ0415	GTJ0416

Moulded Product Series

 <p>GTM0501</p>	 <p>GTM0502</p>	 <p>GTM0503</p>	 <p>GTM0504</p>
 <p>GTM0505</p>	 <p>GTM0506</p>	 <p>GTM0507</p>	 <p>GTM0508</p>
 <p>GTM0508</p>	 <p>GTM0510</p>	 <p>GTM0511</p>	 <p>GTM0512</p>
 <p>GTM0513</p>	 <p>GTM0514</p>	 <p>GTM0515</p>	 <p>GTM0516</p>

Moulded Product Series

			
GTM0517	GTM0518	GTM0519	GTM0520
			
GTM0521	GTM0522	GTM0523	GTM0524
			
GTM0525	GTM0526	GTM0527	GTM0528
			
GTM0529	GTM0530	GTM0531	GTM0532
			
GTM0533	GTM0534	GTM0535	GTM0536

Moulded Product Series

			
GTM0537	GTM0539	GTM0539	GTM0540
			
GTM0541	GTM0542	GTM0543	GTM0544
			
GTM0545	GTM0546	GTM0547	GTM0548
			
GTM0549	GTM0550	GTM0551	GTM0552
			
GTM0553	GTM0554	GTM0555	GTM0556

Stitching Corner sectional View

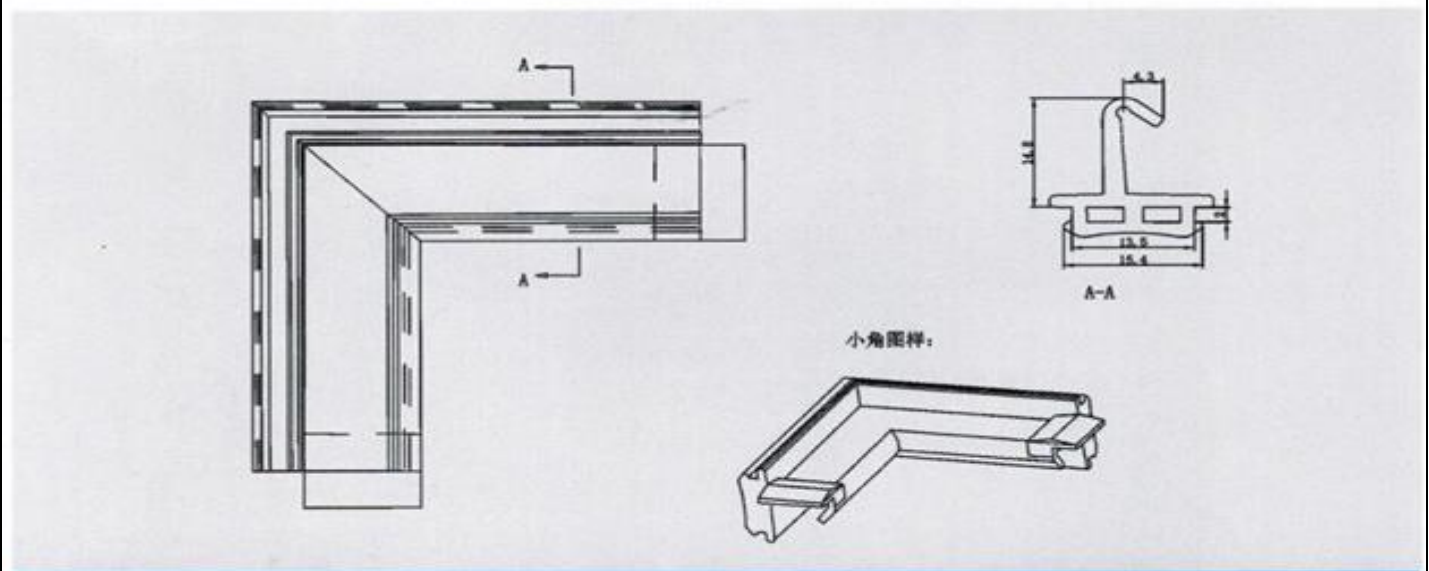
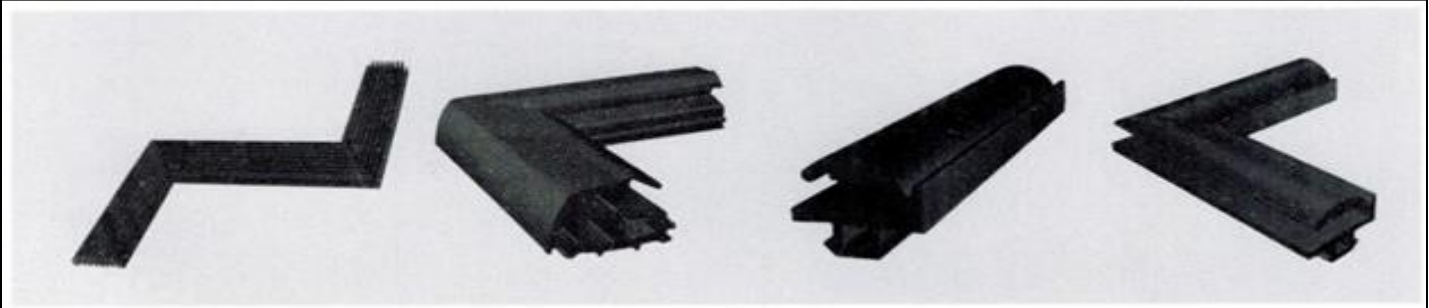

GTJ0709

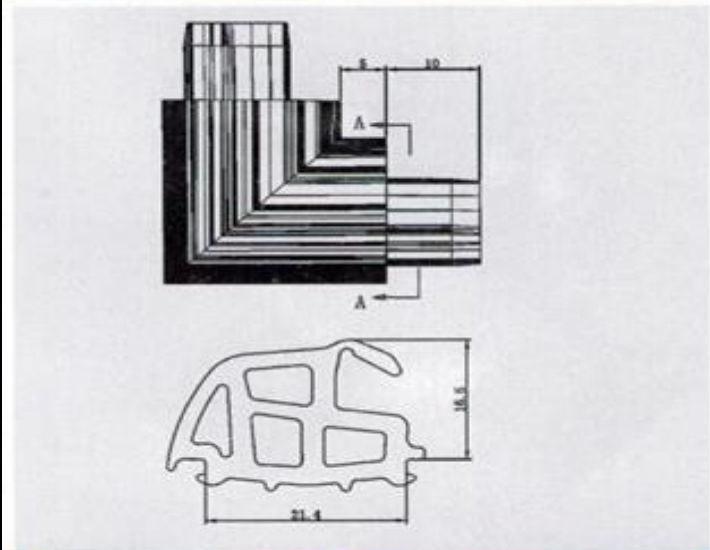

GTJ0710

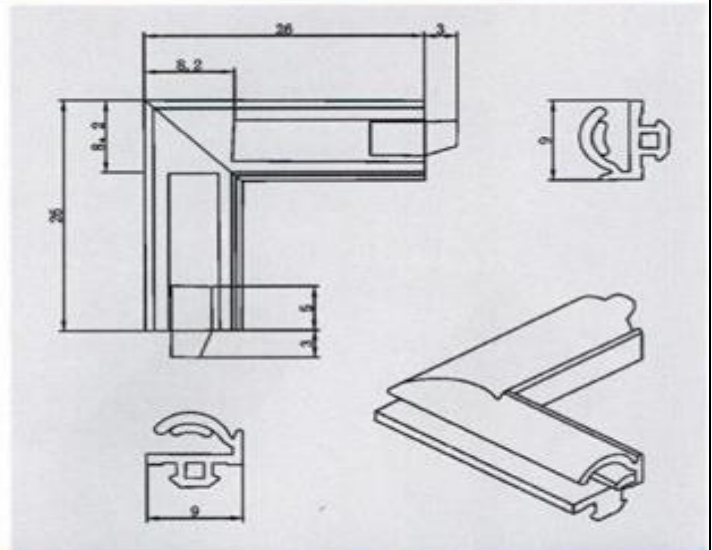

GTJ0711

Building deformation joint rubber sealing strip

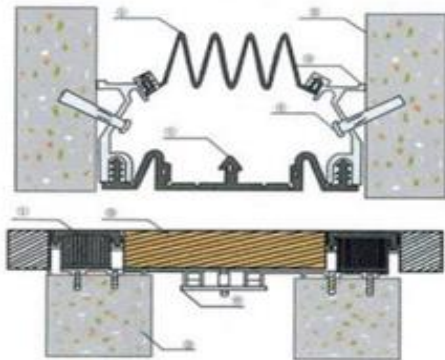

- ① Rubber deformation joint
- ② wall
- ③ Aluminum alloy frame
- ④ Expansion bolt
- ⑤ Decorative material
- ⑥ In shaft

Rubber sealing strip for building curtain wall

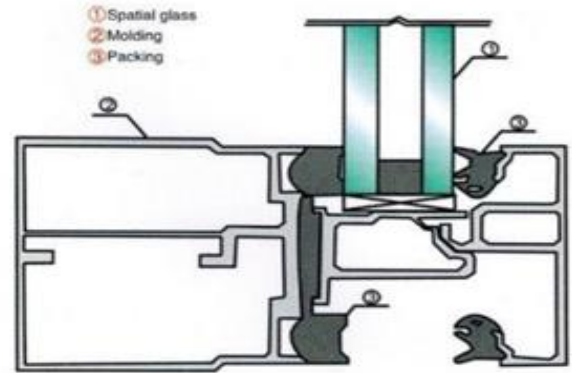

- ① Spatial glass
- ② Molding
- ③ Packing

Rubber sealing strip for aluminum alloy energy saving door and window

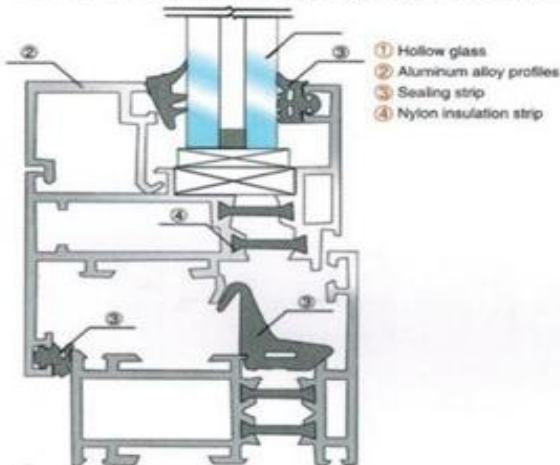

- ① Hollow glass
- ② Aluminum alloy profiles
- ③ Sealing strip
- ④ Nylon insulation strip

Rubber sealing strip for steel doors and windows

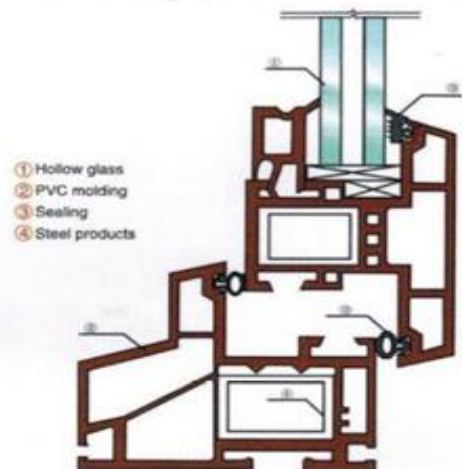

- ① Hollow glass
- ② PVC molding
- ③ Sealing
- ④ Steel products

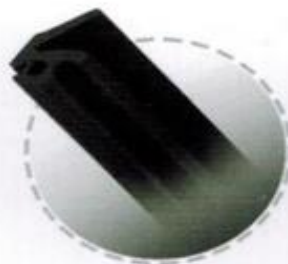
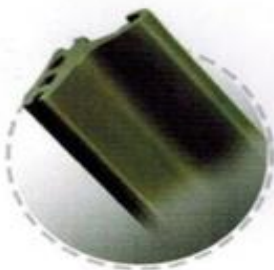

CONTACT INFORMATION

REX Consolidated
80 DLF Industrial Area Phase I
Faridabad Haryana-121003
India

© Copyright 2016 Invicta India Pvt. Ltd.

All information and data stated in this Product Range document has been compiled with utmost care. Nevertheless, Invicta accepts no liability for any errors, omissions or other inaccuracies contained herein. Subject to change without notice. Reprinting or reproduction, in whole or in part, including of photographs, illustrations or graphics, is not permitted without the prior written consent of Invicta India Pvt. Ltd.. We reserve all rights in connection with this document.

Any similarity or resemblance is unintended and is merely a coincidence.

The vehicle applications cited in this Product Range document may possibly be valid only up to the date printed on the last page of the document. All references made in this Product Range document to the item numbers of vehicle manufacturers and/or competitors are provided for the purpose of comparison only. Such information is not allowed to be used in invoices issued to vehicle owners.

For enquiries, please email us : rahul@invictaindia.com

All drawings & illustrations are the property right of INVICTA and cannot be copied, duplicated or re-printed in any form without the prior written consent from INVICTA

Invicta Copyright © 2026

All Right Reserved