

# Pavement Maintenance Solutions



A complete overview of Striping and Road Marking Spray Equipment



PROVEN QUALITY. LEADING TECHNOLOGY.





# ▶ ABOUT GRACO



## ▶ ABOUT GRACO

Graco is a world leader in fluid handling systems and is a renowned quality brand name with almost 100 years experience in moving, measuring, controlling, dispensing, mixing and applying a wide range of fluids and viscous materials. Processing food and cosmetics, applying coatings on walls, furniture, cars, boats, trains and airplanes, marking of lines on roads and sports fields, spraying insulation foam, sealing glass or gluing boxes, lubricating machinery – on-road or off-road, transferring chemicals from A to B, cleaning with high pressure... Graco's innovative technologies are designed to handle these fluids and enable you to achieve your application objectives successfully.

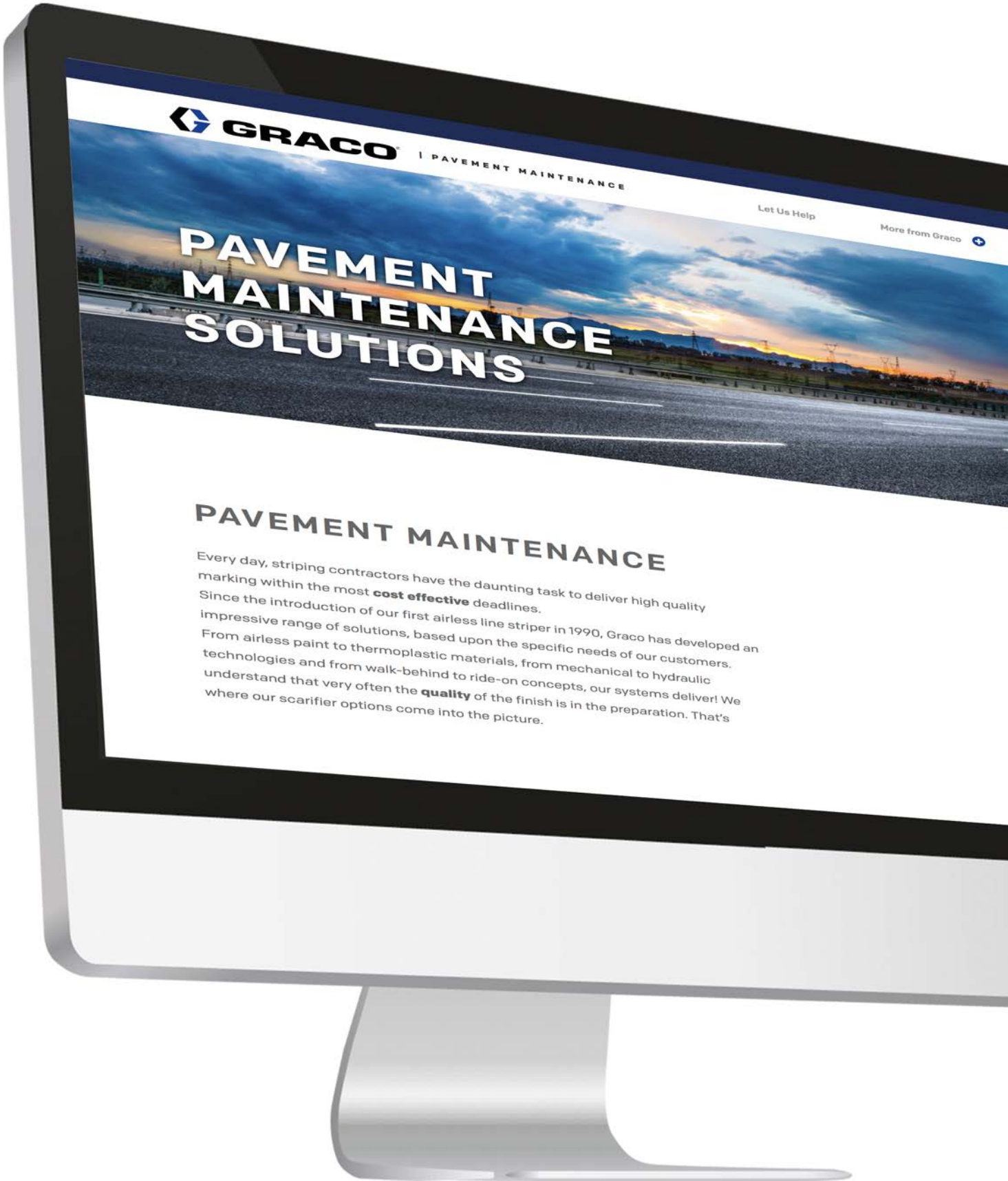

# PAVEMENT MAINTENANCE SOLUTIONS

## PAVEMENT MAINTENANCE

Every day, striping contractors have the daunting task to deliver high quality marking within the most **cost effective** deadlines. Since the introduction of our first airless line striper in 1990, Graco has developed an impressive range of solutions, based upon the specific needs of our customers. From airless paint to thermoplastic materials, from mechanical to hydraulic technologies and from walk-behind to ride-on concepts, our systems deliver! We understand that very often the **quality** of the finish is in the preparation. That's where our scarifier options come into the picture.



▶ **BE THE FIRST TO KNOW!**

The easiest way to stay up to date with our latest innovations is by subscribing to our **digital E-newsletter**. This platform shares success stories from the field, announces new product features and gives our readers VIP info – before anyone else. Subscribe **NOW** at [www.graco.com/stripping](http://www.graco.com/stripping)



▶ **FREE GRACO APP!**

Are you often looking for accessories compatible with Graco's products? Try our **FREE Graco App!** Designed for smartphone or tablet, it is your perfect tool to find what you need in no time.

[www.contractorclub.com](http://www.contractorclub.com)

▶ **CONTACT OUR EXPERTS ONLINE!**

Aiming at the best quality support, our specialised distributors are trained in providing professional local expertise. Can't find what you're looking for and need help?



[www.graco.com/stripping](http://www.graco.com/stripping)



Every day, striping contractors have the daunting task to deliver high quality marking within the most cost effective deadlines. Since the introduction of our first airless line striper in 1990, Graco has developed an impressive range of solutions, based upon the specific needs of our customers. From airless paint to thermoplastic materials, from mechanical to hydraulic technologies and from walk-behind to ride-on concepts, our systems deliver! We understand that very often the quality of the finish is in the preparation.

## Airless Line Striping



Airless painting technology is primarily known for its speed of application. In combination with sharp and crisp line definition, Graco's range of innovative LineLazer systems ensure high quality jobs within the most efficient timeframe.

▶ <b>PAINT APPLICATIONS</b>	<b>08 - 63</b>
<b>LINELAZER™</b>	08 - 39
FEATURES	10 - 21
UNITS	22 - 35
LineDriver™ - LineDriver HD	22
LineDriver ES	23
LineLazer ES 1000	24
LineLazer V ES 2000	25
LineLazer 3400	26
LineLazer V 3900 - LineLazer V 5900	27
LineLazer 130HS	28
LineLazer V 200HS	29
LineLazer V 200DC	30
LineLazer V 250SPS	32
LineLazer V 250DC	33
LineLazer V 200MMA 1:1	34
LineLazer V 250MMA 98:2	35
SPECIFICATIONS	36 - 45
ACCESSORIES	46 - 51
<b>ROADPAK™</b>	52 - 63
UNITS	52 - 53
RoadPak - RoadPak HD System	53
FEATURES	54 - 57
SPECIFICATIONS	58 - 59
ACCESSORIES	60 - 63

# Thermoplastic Striping



In areas with heavy traffic, the durability of road marking is a key priority. Traffic control typically needs to reduce flow obstruction to a minimum. Using thermoplastic material has proven to increase significantly the long term quality of the line. The record drying time of this application contributes greatly to smooth traffic conditions. Technologies like Graco’s on-board melting system and SmartDie applicators don’t just simplify the process, they also offer the control you need of expected line thickness.

- ▶ **THERMOPLASTIC APPLICATIONS** **64 - 73**
- THERMOLAZER™** ..... 64 - 65
- FEATURES ..... 66 - 67
- UNITS ..... 68 - 71
- ThermoLazer 200tc ..... 69
- ThermoLazer 300tc ..... 70
- ThermoLazer ProMelt ..... 71
- SPECIFICATIONS ..... 72
- ACCESSORIES ..... 73

# Parts



Genuine Graco parts greatly contribute to a product’s lifetime. Our set of OEM options add extra flexibility in building application specific systems.

- ▶ **PARTS** **74 - 87**
- OEM PARTS ..... 77
- TIPS & NOZZLES ..... 78 - 82
- HOSES ..... 83
- SWIVELS, ADAPTERS & NIPPLES ..... 84 - 85
- REPAIR PARTS ..... 86 - 87

# Warranty



- WARRANTY ..... 89



# ▶ PAINT APPLICATIONS





## LineLazer™

### FEATURES

#### UNITS

LineDriver  
LineDriver HD  
LineDriver ES  
LineLazer ES 1000  
LineLazer V ES 2000  
LineLazer 3400  
LineLazer V 3900  
LineLazer V 5900  
LineLazer 130HS  
LineLazer V 200HS  
LineLazer V 200DC  
LineLazer V 250SPS  
LineLazer V 250DC  
LineLazer V 200MMA 1:1  
LineLazer V 250MMA 98:2

### SPECIFICATIONS

### ACCESSORIES

## RoadPak™

### FEATURES

#### UNITS

RoadPak  
RoadPak HD

### SPECIFICATIONS

### ACCESSORIES



# ▶ Exclusive Electric Striping Solutions

## ▶ Fume-free, noise-free, and vibration-free performance

Only Graco offers a complete line of electric striping solutions designed to deliver quiet, fume-free performance on indoor jobs, and the power to tackle large outdoor applications.



**LINELAZER ES 1000**  
**PATENT PENDING**

- The industry's first battery-powered striper
- No engine noise, vibration, or fumes
- High-capacity batteries with onboard 12V charger
- Simply plug in to recharge
- Run on 230V wall power - just plug it in



**LINELAZER V ES 2000**  
**STANDARD SERIES**  
**PATENT PENDING**

- Get your job done faster
- Higher output
- Supports 2-gun operation
- LiveLook Display



**LINELAZER V ES 2000**  
**HP AUTOMATIC SERIES**  
**PATENT PENDING**

- Automatic paint gun system
- Simplify layout and skip line work
- Job performance tracking
- J-Log System with USB download



**MAXIMUM ELECTRIC STRIPING PRODUCTIVITY**  
**LINEDRIVER™ ES** **PATENT PENDING**

- No engine noise, vibration, or fumes
- More accurate lines - ExactMil™ speed control and low vibration
- Get the job done fast - higher output with the electric, battery-powered LineDriver ES





### NO ENGINE FUMES

Enables you to stripe indoors without production shut downs or disruptions.

### NO ENGINE NOISE

Do any job anytime, without disruptive engine noise.

### NO ENGINE VIBRATION

Allows for perfect lines on all surfaces and reduces user fatigue.

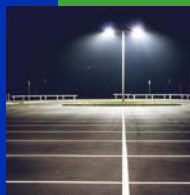

## Typical Applications

### FACTORIES & WAREHOUSES

**INDOOR STRIPING** where exhaust fumes are not allowed

### NIGHTTIME

**OUTDOOR STRIPING** where noise can be a concern

### SPORTS FIELD MARKING

For **PAINTING LINES AND LOGOS** on sports fields

### PARKING GARAGES

Where exhaust fumes and noise can be a concern in **ENCLOSED ENVIRONMENTS**

Product covered by issued and pending patents, see [graco.com/us/en/patents](http://graco.com/us/en/patents).

# Graco Exclusive LazerGuide Solutions

## ► More Profits, less Setup Time

### LazerGuide 2000 Laser-Guided Layout System

- Easy, one-person laser-quality line production to improve productivity and eliminate the need for tape measures, string, or chalk.



**Traditional Method:**  
Requires a string line, chalk and 2 people

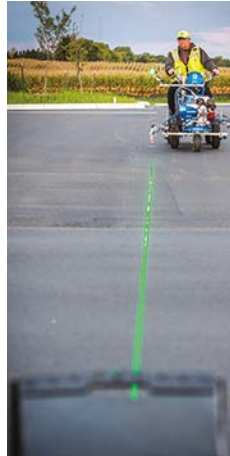

**LazerGuide 2000 Method:**  
No string line, no chalk and 1 person

### Higher Productivity

Stop wasting time with strings, tape measures, and chalk

### Less Labour

One-person parking lot striping

### Less Fatigue

No more kneeling down to move string lines or measuring tapes

### Simple Operation

Just line it up with the target box and go

### Accurate Striping

Straight lines every time - even in windy conditions

## ► Stripe Straighter than ever - Simply Point and Stripe

### LazerGuide 2000 Laser-Guided Layout System

- 1) Place the LazerGuide Target Box
- 2) Line Up the LazerGuide 2000
- 3) Stripe



Parking Lots



Intersections



Athletic Fields



# Graco Exclusive LazerGuide Solutions

## ► Easier, Laser-straight Lines

### LazerGuide 3000 Long-line Laser

- Replace your clunky mechanical pointer to improve your productivity and accuracy for airports, roads, large intersections, or anywhere a straight line is needed.



### Longer Distance Accuracy

Extend reference point up to 10 meter - not possible with a mechanical pointer

### Highly Visible Laser Guide

Quickly locate the laser on all surfaces with Blink Mode

### Safer Operation

Laser is in your natural field of view

### Faster, Simple Operation

Increase your manoeuvrability with no mechanical pointer in the way  
Just line it up and go without the need to get off the machine



## ► Accurate Starts/Stops

### LazerGuide 1700 Start/Stop Laser

- Improve the quality of your line by ensuring that your start and stop points are exactly where you want them to be. Pair with the LazerGuide 2000 or 3000 for the best possible results.

## ► Stripe with Laser Accuracy

### LazerGuide 1700 Start/Stop Laser

- Line up the LazerGuide 1700 Start/Stop Laser directly under your spray tip to ensure accurate start/stop locations when striping, resulting in perfect lines every time.



# Enhancing Line Quality

## ▶ A.V.R.S. = Advanced Vibration Reduction System

Removes engine vibration and takes line quality to the next level.



without A.V.R.S.



with A.V.R.S.

### How does it work?

Uneven road surfaces and a running engine produce vibrations. These are transferred to the striping gun(s) and thus prevent the gun(s) from maintaining a perfectly fixed angle over the surface

### New Concept

Graco invents the AVRS system which reduces vibrations up to 60%. Less vibrations simply result in better quality lines

### A.V.R.S.

Reduced vibration is achieved with an exclusive pump sprayer, a mounting system and a new single gun bar holder

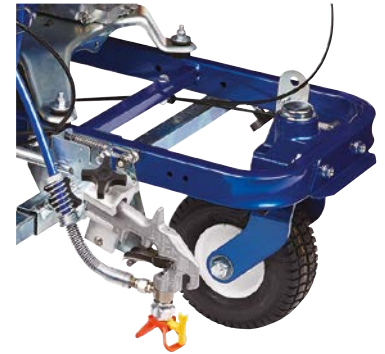

## ▶ Rear Gun Mounting

### Rear Gun Mounting

Photo on the right shows the result obtained when striping 2 lines simultaneously: one gun mounted at the front and a second at the rear. Same machine, same speed, same paint

### Straighter Lines

Lining up the gun(s) with the two rear wheels and axles results in straighter lines

### Front & Rear Mount

Mounting the gun at the front of the machine is a requirement to stripe up to the curb on a parking lot. However, for long line pavement applications, mounting the gun at the rear improves straightness and consistency of the lines

### Easy

The rear gun mounting option eliminates the need to reverse the mount of the engine and the handle

## ▶ Easy Out™ Pump Filter



**The easy out pump filter is designed to filter from the inside out:**

- Filters won't get stuck or collapse when filled with direct or debris
- Large 125 cm<sup>2</sup> filtering area reduces tip clogs and ensures a quality finish
- Vertical filter removes with the cap for less mess

# Endurance™ Pump: Prolonging Pump Life

## ► Graco's Long Life Chromex Endurance Pump sets the industry standard

- Handle the most demanding materials with long-life rod treatment and V-Max Blue™ packings
- Durable Chromex™ rod and stainless steel sleeve deliver superior reliability and life

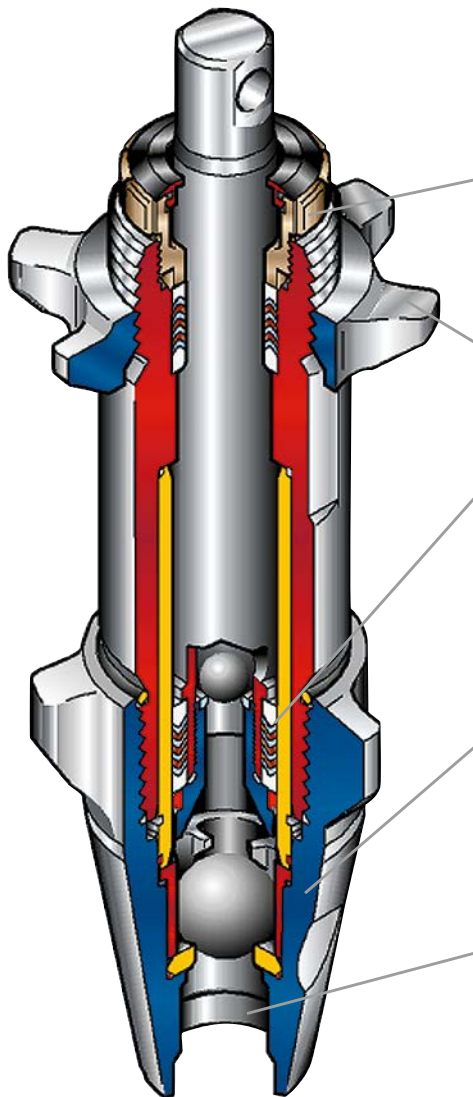

### (A) Adjustable Packing Nut

- When the upper packings are worn out, paint leaks out and pressure drops
- With Graco, you can finish the job by tightening the nut instead of stopping for repair

### (B) Quick Knock-Off™

- To remove the risk of downtime, replace the complete pump, on the job, in about 15 minutes

### (C) "V"-Max Blue™ Packing

- Ultra High Molecular Weight Polyethylene material is compatible with solvent and water-based coatings
- V-Max Design means the packings constantly adjust to pressure and wear = longer lasting

### (D) QuikAccess™

- Graco pumps are field serviceable with only a hammer and a wrench
- Access the inlet and outlet without downtime and costly repairs

### (E) EasyFlow™

- All fluid passages (SST) are machined with smooth curves
- The less fluid frictions allow more flow and heavier coatings

# LineLazer™ V Adjustment Systems

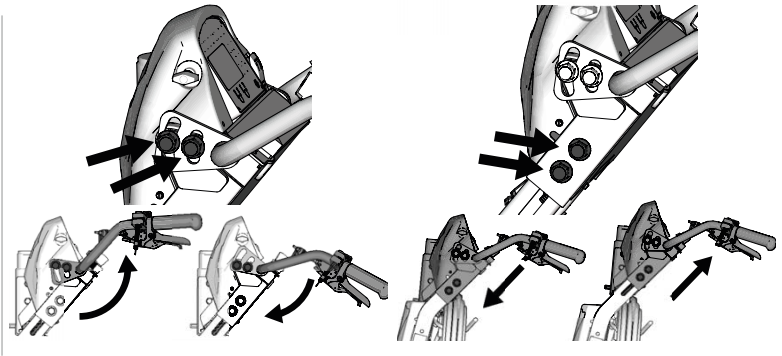

## ► DualComfort Handlebar System

### Improved comfort for all day striping

- Easily adjust the handle bar angle and height
- Sturdy and solid design
- Perfect fit for all size users

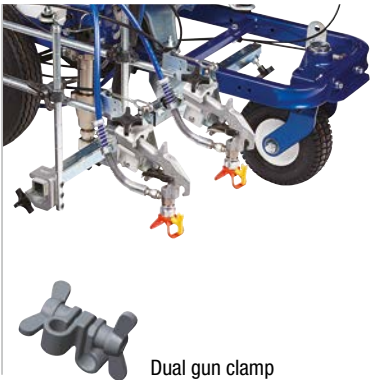

## ► EasyMark Gun Adjustment System

### Gun Adjustment has never been easier

- Markings on gun bars for easy operation
- Removable “G-Clamp” is Industry-First
- New Dual Gun Clamp for solid gun control
- Provides perfect 2-gun alignment

**PATENT PENDING**



## ► EZ Align™ Wheel System

### Improved Front Wheel Adjustment System

- Allows simple realignment of front wheel to maintain “straight” tracking
- No special tools needed to adjust
- Quick and easy “Fine Tune Adjustment”

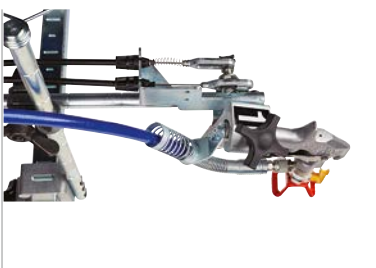

## ► HP Automatic Double Gun Trigger System

### Manual or Automatic Gun control, you choose how to operate your guns!

- Individual gun control system
- Manual control via lever
- Automatic control via push button
- Direct AutoLayout via Auto Guns

See the manual of your LineLazer for more details and instructions

# LineLazer™ V Adjustment Systems

## ▶ LineLazer V LiveLook Display with SmartControl™

LineLazer V comes delivered with an all new LiveLook Display, providing you all your striping information at a glance. The Standard Series allows you to track and show every aspect of your striping job while the HP Automatic Series offers you much more capabilities like Auto and Semi-Auto Guns, Jobsite Data Logging and AutoLayout™.



## ▶ LineLazer V Standard Series: ES 2000 - 3900 - 5900 - 200

Track, measure, and control every aspect of your striping job.

Set the unit to your preferred measurements, indicating volume in gallons or liters; pressure in psi, bar or MPa; distance in feet or meters which also changes line thickness in mils or microns and speed in mph or kph.

## ▶ LineLazer V HP Automatic Series: ES 2000 - 3900 - 5900 - 200 - 250

The HP Automatic Series comes equipped with Automatic guns allowing you to step up in the Road Marking business. Program your unit for automatic or semi-automatic skip-lines, Auto-Layout functionality with built-in parking lot calculators and much more.

## ▶ Main Screens

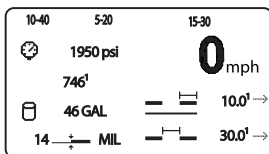

### Main Striping Screen

- Speed
- Pressure
- Litres
- Line thickness
- Line width
- Skip line (*HP Automatic and HP Reflective series*)

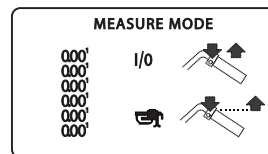

### Measure Mode

Measure distances using your unit

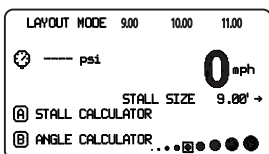

### Layout Mode

(*HP Automatic and HP Reflective Series*)

- Premark your jobsite
- Lay out a parking lot
- Calculate straight parking lots
- Calculate angled parking lots

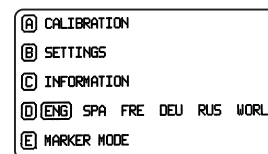

### Settings/Information

- Calibrate your unit
- Set your preferences
- Unit Information
- Language settings
- Marker mode (*HP Automatic and Reflective only*)

## ▶ Calibration Screen

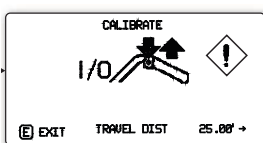

### Calibrate your unit for accurate measurements on each jobsite:

- Speed indication
- Line Thickness calculation
- Measure Mode
- Auto guns (*HP Automatic and HP Reflective Series*)

See the manual of your LineLazer for more details and instructions



# LineLazer™ V Adjustment Systems

## ▶ LineLazer V Automatic Guns

Putting down skip lines has never been easier with automatic guns. With Auto Mode and Semi-Auto Mode, you can control any skip line requirement on jobsites.

### Striping truck features now on a walk-behind unit!

- Program guns to start and stop automatically to deliver perfect lines every time!
- Stripe skip lines with a simple push of a button
- Push button control eliminates hand lever fatigue
- Use semi-automatic mode for single lines with fixed lengths

### Select the gun that you want to use



### Activate the guns for spraying

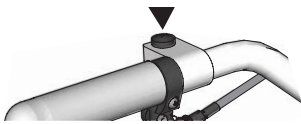

### Automatic guns allow you to spray different types of road markings

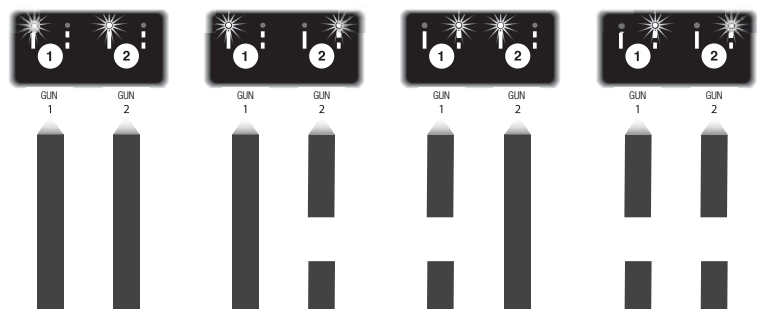

## ▶ LineLazer V AutoLayout II System

Whatever the requirements are for a parking lot layout, AutoLayout II on your LineLazer V HP Automatic or HP Reflective series can limit your manual measuring work and lay out the dots where you want it to directly from the gun.

### Finish Jobs Faster

- Up to 30% faster with walk behind strippers
- Up to 50% faster when using the LineDriver attachment

### Less Hassle, Less Fatigue

- No bending to mark the lines
- Eliminates the strain to read the tape measure
- Takes the hassle out of calculating distances and stall sizes
- Simple to use every time

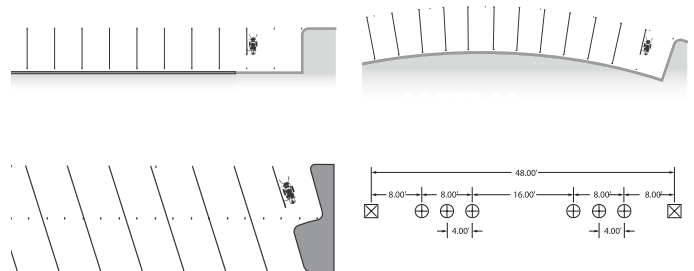

### Screen Overview

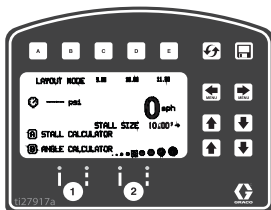

#### Layout Mode:

Use the Layout Mode screen for your Premark or Layout requirements.

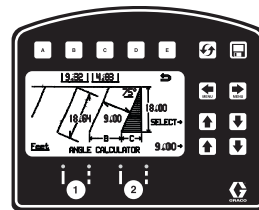

#### Angle Calculator:

Advance in parking lots and calculate the offset for angled parking lots helping you to lay out any parking lot design.

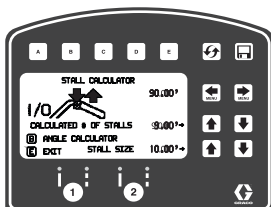

#### Stall Calculator

Preset your unit to lay out parking lots. Calculate the number of stalls or the stall size.

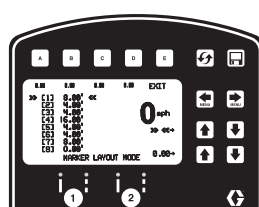

#### Marker Layout Mode:

Predefine marker layouts that do not have consistent distances in between.

# LineLazer™ V Adjustment Systems

## ► J-Log System: Jobsite Data Logging

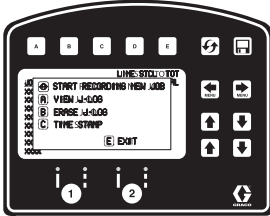

JOB	DATE	TIME	FEET	MIN	IN	IN	IN	IN
0001	25.12.2015	1:00	3:800	12	12.1	14.0	0.0	1.1
0001	25.12.2015	2:00	10:000	14	14.7	0.7	2.0	2.7
0001	25.12.2015	3:00	4:000	15	15.0	3.0	1.0	4.5
0002	25.12.2015	3:00	0	0	0	0.0	4.0	4.0
0002	25.12.2015	6:00	11:000	14	14.9	3.9	1.0	4.9
0002	25.12.2015	7:00	10:000	14	14.3	0.3	0.0	0.3
0003	25.12.2015	9:30	7:000	15	15.3	2.3	0.5	2.8
0003	25.12.2015	10:40	12:000	12	12.1	14.0	1.0	5.1

Track your jobsite data with your unit. Let the unit save data every hour or manually select the moment you need to save data.

### Sub Menu Screens



Set your unit to your needs: time, pressure, volume, contrast, guns

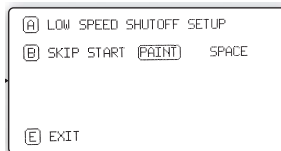

Control your auto-guns with even more advanced gun settings:

- Shut off your guns at low speeds
- Start you skip lines with paint or space

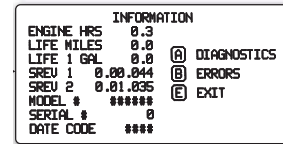

Control in depth information of your unit and check software revision and error codes.

## ► World Symbols for LineLazer V LiveLook Display

LineLazer V LiveLook Display is equipped with a World Symbols feature which can be used in any language.

STRIPING MODE	MEASURE MODE	LAYOUT MODE	SETTINGS/DATA	DATA LOGGING
<p><b>M S A</b> MANUAL OR AUTOMATIC MODE</p> <p> PRESSURE</p> <p> GALLONS/LITERS</p> <p> LINE THICKNESS</p> <p> PAINT LENGTH</p> <p> SPACE LENGTH</p> <p> LINE WIDTH</p> <p> EXIT</p> <p> YELLOW</p> <p> WHITE</p> <p> BLACK</p> <p> BLUE</p> <p> GREEN</p> <p> RED</p> <p> BATTERY LOW</p> <p> BATTERY CHARGING</p>	<p> PRESS TO START/STOP</p> <p> HOLD TO SPRAY A DOT</p>	<p> STALL CALCULATOR</p> <p> ANGLE CALCULATOR</p> <p> STALL WIDTH</p> <p> DOT SIZE SELECTOR</p>	<p> CALIBRATE</p> <p> SETTINGS</p> <p> UNITS</p> <p> INFORMATION &amp; LIFE DATA</p> <p> MARKER LAYOUT MODE</p> <p> GUN SETTINGS</p> <p> SPECIFIC GRAVITY</p> <p> ENGINE HOURS</p> <p> TOTAL DISTANCE</p> <p> TOTAL GALLONS</p> <p> SOFTWARE REV</p> <p> ERROR CODES</p> <p> CONTRAST</p> <p> DIAGNOSTICS</p> <p> TIME AND DATE</p> <p> LOW SPEED SHUTOFF</p>	<p> START RECORDING NEW JOB</p> <p> JOBS</p> <p> TIME STAMPS</p> <p> SCROLL</p> <p> DELETE</p> <p> DISTANCE PAINTED</p> <p> GALLONS OF LINE PAINTED</p> <p> GALLONS OF STENCIL PAINTED</p> <p> TIME AND DATE</p> <p> TOTAL GALLONS/LITERS</p>

# Battery Powered LineLazer™ EPOWER Series



## ▶ 100 Ah Deep-Cycle AGM Battery

### No Exhaust Fumes – No Noise

- Maintenance Free
- Holds up well to vibrations
- Fast recharge time
- Can be “Deep-Cycled” without drastically reducing battery life
- Spray up to 75 litres with one battery and up to 200 litres with 2 batteries



## ▶ On-Board 12V Charger

### Plugs into 230V wall-power

- No external charger needed, only extension cable
- Simple recharge, just plug it in
- Voltage display while using and charging

## ▶ 230V Capability

### Infinite spray time

- Spray while plugging in to 230V wall-power
- Even when battery is depleted
- Use as a stationary sprayer, ideal for stencil jobs



## ▶ Easy Access Controls

### Manage your unit at the handle bar

- On-off switch for pumping system
- Pressure Control with ECO-Mode for optimal battery usage
- LiveLook Display with unit and jobsite information on ES 2000
- Storage space on ES 1000



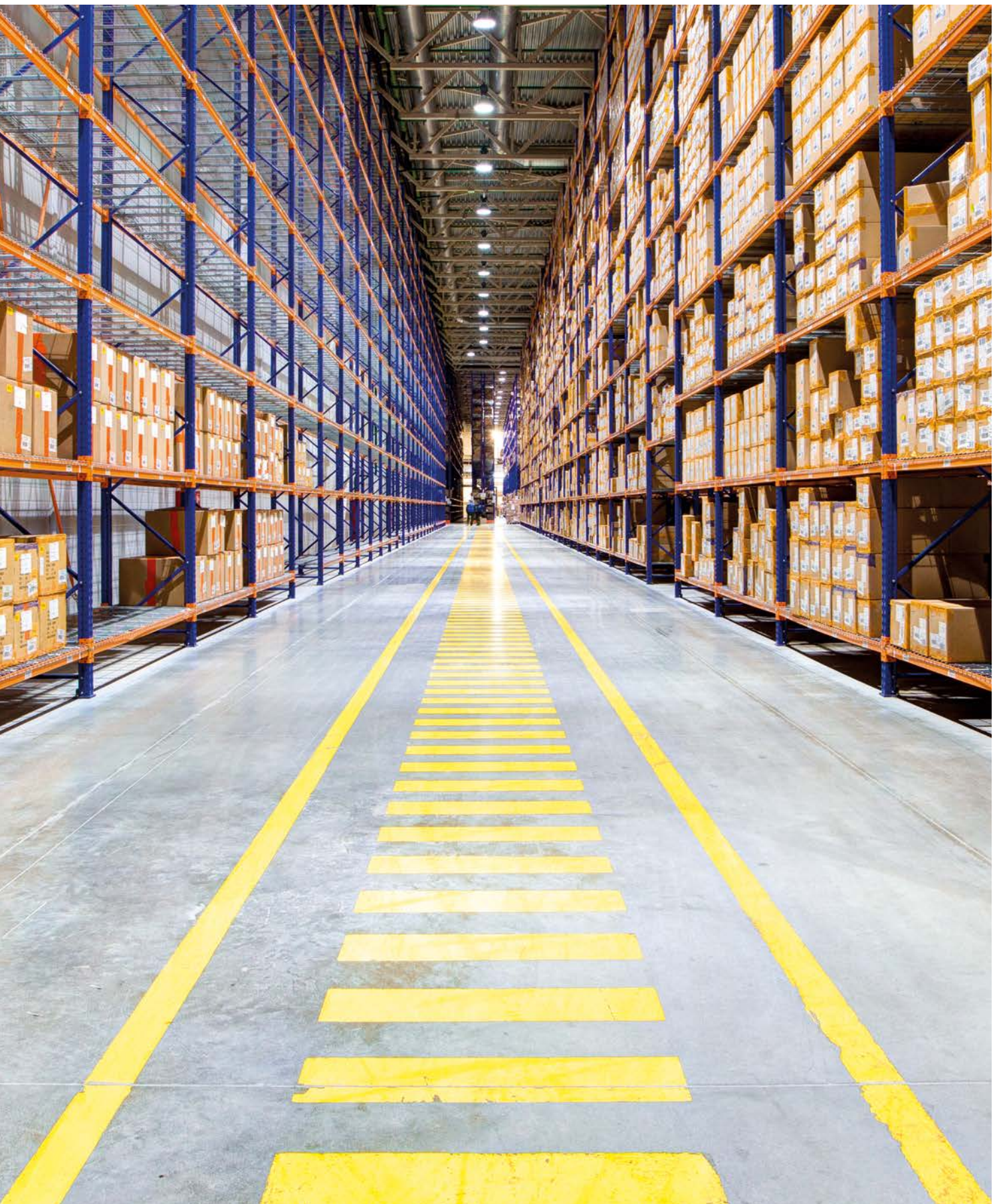



# LineDriver™ - LineDriver™ HD

## Ride-On System

Why walk when you can ride? Graco LineDriver and LineDriver HD attachments connect to your LineLazer striper to provide the most innovative, user-friendly ride-on systems available to double your striping productivity.

### Low-light Accuracy - FlexBeam™ LED Light System

- LED light for improved brightness with long life and less amp draw
- Retractable, breakaway design prevents damage and keeps you striping

### Ride with Ease - Patented Dual Foot Pedal System

- Adjustable pedals to fit every user
- Forward and reverse capability

### Easy Starting - Exclusive ProStart™ Engine Starting System

- Up to 50% less pulling effort to start the engine
- Outperforms other starting systems in cooler weather

### Ultimate Comfort - Cool-Comfort™ Seat

- Grey colour stays cool in direct sunlight
- High-back seat for added support
- Extra padding for all-day comfort

### Reliable, easy-to-start - Honda® Engine

- Contractor preferred - excellent power and proven reliability



Dual Foot Pedal System



LineDriver

# LineDriver™ ES

Electric Battery-Powered Ride-On System



Why walk when you can ride? The Graco LineDriver ES is the quietest, most innovative, user-friendly ride-on system.

Simply connect the LineDriver ES to your LineLazer striper to double your striping productivity on any indoor or outdoor job, without the engine noise, vibration, or fumes.

## High-Speed Production Efficiency

- 16 kph (10 mph) maximum speed
- 9-12 hours of run time

## Quiet, All-Day Reliable Power - High-Capacity Batteries

- Four, 6 V Sealed Lead-Acid 225 Ahr AGM Batteries

## Consistent Lines Every Time - ExactMil™ \* Speed Control

- Set your speed for guaranteed perfect lines every time
- Exactly meet the mil thickness requirement - resulting in quality work with no wasted paint

## Superior Control and Extended Run-Time - SmartDrive™ Technology with Advanced Eco-Mode

- Performance and feel of a Gas-powered LineDriver
- Regenerative braking recharges batteries to extend run-time
- Eco-Mode allows up to 12 full hours of run time and precise control at low speeds

## Simple, Plug-In Charging - Onboard 24 V Charger

- Longer battery life with extended battery-tender feature

## Easy Accessory Charging - Dedicated 12 V Power Supply

- Dual "cigarette lighter" power supplies for all your accessories
- Dual LED light outputs

## Quick-View Power Level - Battery Monitor System

- Displays battery level for easy recall
- Alerts user when battery is low and requires a recharge

## On-Hand Storage - Back Rack Storage Shelf

- Convenient storage for on-the-job supplies

\* PATENT PENDING



# LineLazer™ ES 1000

Mechanical Walk Behind Striper



LineLazer™ ES 1000



Battery Compartment



Built-In Charger

## ► Applications & Materials

Striping without exhaust fumes or noise? Powered by a high-output battery, the LineLazer ES 1000 is safe to use indoors while having the power and performances needed for all jobs.

## ► Features & Benefits

### No Engine noise, vibration and exhaust fumes

- Complete any job at any time without production shutdowns or disruptions
- Reduce user fatigue while delivering perfect lines on all indoor and outdoor surfaces

### Quiet, reliable power

- Maintenance-free sealed deep-cycle 12V 100Ah AGM battery
- Stripe up to 75 liters per charge
- Add a second battery and get up to 200 liters per charge

### On-Board 230V Charger

- Built-In Charger System for 230V. Simply plug in to recharge, no need to remove the battery 230V capability
- Get infinite spray time when using for stationary applications by running on 230V wall power

See page 20 for more detail

### Exclusive LineLazer™ frame

- Industry's best-balanced chassis allows for straighter lines
- Accepts LineDriver, 55 liter hopper, EZ Bead™ system, pointer, LaserGuide systems and LED light

### DualComfort™ Handlebar System

- Fits all users and easy to adjust
- Solid 4-bolt design

### EZ Align™ Front Wheel System

- Simple front wheel alignment keeps unit tracking straight
- Intuitive design without needing any special tools

### EasyMark™ Gun Adjustment System

- Simple guide mark system
- Easy gun on/off, front/back
- Perfect gun set up every time



# LineLazer™ V ES 2000

Battery Operated Mechanical Walk Behind Striper



LineLazer™ V ES 2000



LineDriver ES



LiveLook Display

## ► Applications & Materials

Need more output, dual gun capability and features from a battery powered LineLazer? The LineLazer V ES 2000 is powered by the same high-output battery as the ES 1000 and is available as a Standard and HP Automatic series striper.

### ► LineLazer V Features & Benefits

#### No Engine noise, vibration and exhaust fumes

- Complete any job at any time without production shutdowns or disruptions
- Reduce user fatigue while delivering perfect lines on all indoor and outdoor surfaces

#### Quiet, reliable power

- Maintenance-free two sealed deep-cycle 12V 100Ah AGM battery
- Stripe immediately up to 200 liters per charge

#### LiveLook™ Display with SmartControl™

- Track, measure and control every aspect of your job
- Real-time information for the perfect lines

#### EZ Align Front Wheel System

- Simple front wheel alignment keeps unit tracking straight
- Intuitive design without needing any special tools

Includes all Standard Series Features PLUS:

### ► LineLazer V HP Automatic Series Features & Benefits

#### Automatic Paint Gun System

- Push button control for lower operator fatigue and accurate (skip-)lines
- Manual, semi- and automatic guns/mode

#### Auto-Layout™ II

- SmartControl™ measures while you walk and puts down pre-marks
- No need for measuring tape or string lines cutting
- Cuts your parking lot layout time in half

#### Valuable job information with J-Log System

- Onboard job information for proof of completion
- USB download allows you to capture all job data

See page 36 for more detail on 1- and 2-gun offering in Standard and HP Automatic Series

# LineLazer™ 3400

Mechanical Walk Behind Striper



LineLazer™ 3400



Front Swivel Wheel



Stencilling

## ► Applications & Materials

The LineLazer 3400 is the preferred choice for contractors who are looking for professional performance in a 1-gun striper. This striper is ideal for parking lots and seal coating contractors, schools, park and recreation departments.

## ► Features & Benefits

### Handlebar Design

- Adjustable design, allows for optimal ergonomics and reduced vibration on your hands or all-day striping comfort.
- Contoured grips comfortably fit your hands

### Updated frame

- 7 cm longer for greater stability and straighter lines
- Now accepts 55 liter hopper and EZ Bead™ system

### Front Swivel Wheel

- Provides easier "up to the curb" parking lot striping and hard-to-do curves
- Tapered locking pin design for years of dependable operation

### EasyMark Gun Adjustment System

- Simple guide mark system
- Easy gun on/off, front/back
- Perfect gun set up every time

### Rear Mount Hose Wrap

- Provides easy on/off for stencilling applications

### Electronic Pressure Control

- Accurate, tight tolerance system provides excellent line quality

See page 38 for more detail

# LineLazer™ V 3900 - LineLazer™ V 5900

Mechanical Walk Behind Stripers



LineLazer™ V 5900

LineLazer™ V 3900

## ► Applications & Materials

The LineLazer V 3900 is the airless line striping choice for professional striping contractors who want the industry's best striping unit. The LineLazer V 5900 continues to be the mid to heavy-duty striping solution for professional contractors who recognize the increased productivity this leader delivers.

## ► Features & Benefits

### LiveLook™ Display with SmartControl™

- Track, measure and control every aspect of your job
- Real-time information for the perfect lines

### DualComfort™ Handlebar System

- Fits all users and easy to adjust
- Solid 4-bolt design

### EZ Align Front Wheel System

- Simple front wheel alignment keeps unit tracking straight
- Intuitive design without needing any special tools

### EasyMark Gun Adjustment System

- Simple guide mark system
- Easy gun on/off, front/back
- Perfect gun set up every time

## ► Includes all Standard Series Features PLUS: Features & Benefits

### Automatic Paint Gun System

- Push button control for lower operator fatigue and accurate (skip-)lines
- Manual, semi- and automatic guns/mode

### Auto-Layout™ II

- SmartControl™ measures while you walk and puts down pre-marks
- No need for measuring tape or string lines cutting
- Cuts your parking lot layout time in half

### Valuable job information with J-Log System

- Onboard job information for proof of completion
- USB download allows you to capture all job data

### OnBoard Power

- 12V battery for all your accessory items

See page 38-40 for more detail on 1- and 2-gun offering in Standard and HP Automatic Series



# LineLazer™ 130HS

Hydraulic Walk Behind Striper



LineLazer™ 130HS

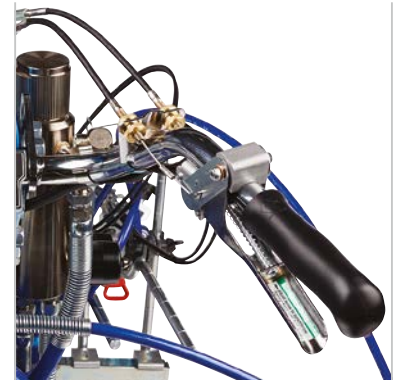

## ► Applications & Materials

The LineLazer 130HS is the ultimate hydraulic airless striping unit that contractors rely on for their most challenging striping jobs. Professional striping contractors wanting hydraulic performance and proven power cannot go wrong with the LineLazer 130HS.

## ► Features & Benefits

### Storage Compartment

- Convenient storage area for tips, guards and miscellaneous items

### DualComfort™ Handlebar System

- Fits all users and easy to adjust
- Solid 4-bolt design

### EZ Align Front Wheel System

- Simple front wheel alignment keeps unit tracking straight
- Intuitive design without needing any special tools

### EasyMark Gun Adjustment System

- Simple guide mark system
- Easy gun on/off, front/back
- Perfect gun set up every time

### QuickSelect Gun Selector

- Independently control two guns with one chrome gun lever

### Honda Power

- Contractor preferred – excellent power and proven reliability
- Oil Alert shuts down engine to prevent damage if oil level drops too low

### Exclusive Easy Out Filter System

- 50 mesh filter for no plug performance
- Inside-out design means less mess and fewer tip clogs

### Rear Gun Mount System

- Place the guns near the rear axle for straighter long lines and smoother curved lines

See page 38 for more detail on 1- and 2-gun offering

# LineLazer™ V 200Hs

Hydraulic Walk Behind Striper



STANDARD  
SERIES

HP AUTOMATIC  
SERIES

HP REFLECTIVE  
SERIES

LineLazer™ V 200Hs



LineLazer™ V 200Hs HP Reflective

## ► Applications & Materials

The LineLazer V 200Hs is the high performance hydraulic striper you'll want for your most demanding jobs. It's proven history of innovative features has made it the striper of choice for contractors demanding a true workhorse. The LineLazer V 200Hs is the perfect unit for large parking lot jobs, airports, and city jobs that not only require precise lines but also demand reflective beads.

### ► Includes all Standard Series Features PLUS: **Features & Benefits**

#### Automatic Paint Gun System

- Push button control for lower operator fatigue and accurate (skip-)lines
- Manual, semi- and automatic guns/mode

#### Auto-Layout™ II

- SmartControl™ measures while you walk and puts down pre-marks
- No need for measuring tape or string lines cutting
- Cuts your parking lot layout time in half

#### Valuable job information with J-Log System

- Onboard job information for proof of completion
- USB download allows you to capture all job data

#### Onboard Power

- 12V battery for all your accessory items

### ► Includes all HP Automatic Series Features PLUS: **Features & Benefits**

#### Pressurized Bead System

- Onboard closed compressor avoids dust and debris from entering
- Ensures proper bead flow and paint penetration
- Large volume bead tank holds up to 54kg
- Bead gun activates automatically with spray gun
- Bead gun with gun-delay ability
- Adjustable nozzle for bead dispensing width adjustment

See page 38-42 for more detail on 1- and 2-gun offering in Standard, HP Automatic and HP Reflective Series

# LineLazer™ V 200dc

Hydraulic Dual Colour Walk Behind Striper



LineLazer™ V 200dc



LineLazer™ V 200DC Standard

## ► Applications & Materials

The LineLazer V 200DC offers you Dual Colour Capability in a push-behind hydraulic airless striping unit. Offered in Standard, HP Automatic and HP Reflective series, the LineLazer V 200DC offers you two units in one. Take one unit to a two-colour jobsite and get the job done faster! As a bonus you'll save on transport compared to transporting two units for individual colours.

*LINELAZER V 200DC includes same features as LineLazer V200HS PLUS:*

## ► Features & Benefits

### Dual-Colour capable

- Dual colour applications with a single unit improves efficiency and profitability

### Dual Graco Hydraulic Motors

- No-stall hydraulic design provides uninterrupted performance

### Dual Endurance Piston Pumps

- Long life pumps provide precise flow for a wide range of striping materials

### Dual 38 Litre hoppers

- Extended striping time with large capacity hoppers

### Onboard Power

- 12V battery for all your accessory items

See page 39-42 for more detail on 1- and 2-gun offering in Standard, HP Automatic and HP Reflective Series







# LineLazer™ V 250sps

Hydraulic Ride-On Striper



LineLazer V 250sps *HP Automatic*



LineLazer V 250sps *HP Reflective*

## ► Applications & Materials

High performance, self-propelled striping with automatic paint guns makes the LineLazer V 250sps the preferred striper for professional contractors who demand more. This striper is ideal for large, heavy-duty line striping jobs including parking lots and road jobs.

### ► Features & Benefits

#### Automatic Paint Gun System

- Push button control for lower operator fatigue and accurate (skip-)lines
- Manual, semi- and automatic guns/mode

#### Exclusive Stand-On Platform

- Integrated platform provides an ergonomic place for standing, great view and all-day comfort

#### Self-Centering Front Wheel

- Eliminates one user interface for simpler operation
- Foam filled for stability

#### EasyMark Gun Adjustment System

- Simple guide mark system
- Easy gun on/off, front/back
- Perfect gun set up every time

### ► Includes all HP Automatic Series Features PLUS: Features & Benefits

#### Pressurized Bead System

- Onboard closed compressor avoids dust and debris from entering
- Ensures proper bead flow and paint penetration
- Large volume bead tank holds up to 54kg
- Bead gun activates automatically with spray gun
- Bead gun with gun-delay ability
- Adjustable nozzle for bead dispensing width adjustment

See page 38-43 for more detail on 1- and 2-gun offering in HP Automatic and HP Reflective Series

# LineLazer™ V 250dc

Hydraulic Dual Colour Ride-On Striper



LineLazer V 250dc HP Automatic



LineLazer V 250dc HP Reflective

## ► Applications & Materials

Spray two colours simultaneously with Graco's new LineLazer V 250dc. Ideally suited for airports, municipalities, DOTs or anyone who needs to spray highlight lines or other dual-colour striping.

## ► Features & Benefits

### Dual-Colour capable

- Dual colour applications with a single unit improves efficiency and profitability

### Dual Graco Hydraulic Motors

- No-stall hydraulic design provides uninterrupted performance

### Dual Endurance Piston Pumps

- Long life pumps provide precise flow for a wide range of striping materials

### EasyMark Gun Adjustment System

- Simple guide mark system
- Easy gun on/off, front/back
- Perfect gun set up every time

## ► Includes all HP Automatic Series Features PLUS: Features & Benefits

### Pressurized Bead System

- Onboard closed compressor avoids dust and debris from entering
- Ensures proper bead flow and paint penetration
- Large volume bead tank holds up to 54kg
- Bead gun activates automatically with spray gun
- Bead gun with gun-delay ability
- Adjustable nozzle for bead dispensing width adjustment

See page 38-43 for more detail on 2- and 3 gun offering in HP Automatic and HP Reflective Series

# LineLazer™ V 200MMA 1:1

Hydraulic Walk Behind 2-Component 1:1 Striper



LineLazer V 200MMA 1:1  
(unit shown includes optional LazerGuide 1700)

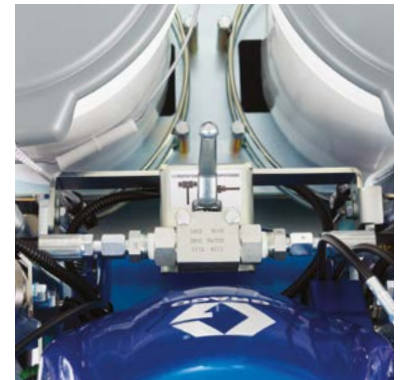

1:1 Hydraulic Proportioner



Air-Purge Fusion Gun

## ► Applications & Materials

The Graco LineLazer 200MMA 1:1 delivers superior performance that guarantees ratio assurance with a 1:1 hydraulic proportioner and an Air-Purge Fusion gun from Graco, a +10 year Industry Proven 2-component internal mixing gun with Air-Purge flushing capability. No need to carry solvent during the jobsite, the gun is purged using compressed air.

## ► Features & Benefits

LINELAZER V 200MMA 1:1 includes same features as LineLazer V200DC HP Reflective PLUS:

### Dual Graco Hydraulic Motors

- No-stall hydraulic design provides uninterrupted performance

### Dual Endurance Piston Pumps

- Long life pumps provide precise flow for a wide range of striping materials

### Dual Paint Bucket holder

- Extended striping time with large 55 litre capacity buckets

### Precise MMA 1:1 Ratio

- Innovative Flow Divider guarantees equal material flow of each component
- Built-in bypass valve for independent pump operation

### Graco Fusion™ Air-Purge Gun mixes materials “at the gun”

- Instant air purge after every line, or disable for purging after last skip-line
- Clears all material in the mixing chamber and eliminates buildup of material on the tip
- Quick-release fluid housing lets you easily change mix chamber without tools
- RAC® 5 SwitchTips™ for easy clearing of a tip clog

See page 38-43 for more detail on 1- and 2-gun offering in Standard, HP Automatic and HP Reflective Series



# LineLazer™ V 250MMA 98:2

Hydraulic Ride-On 2-Component 98:2 Striper

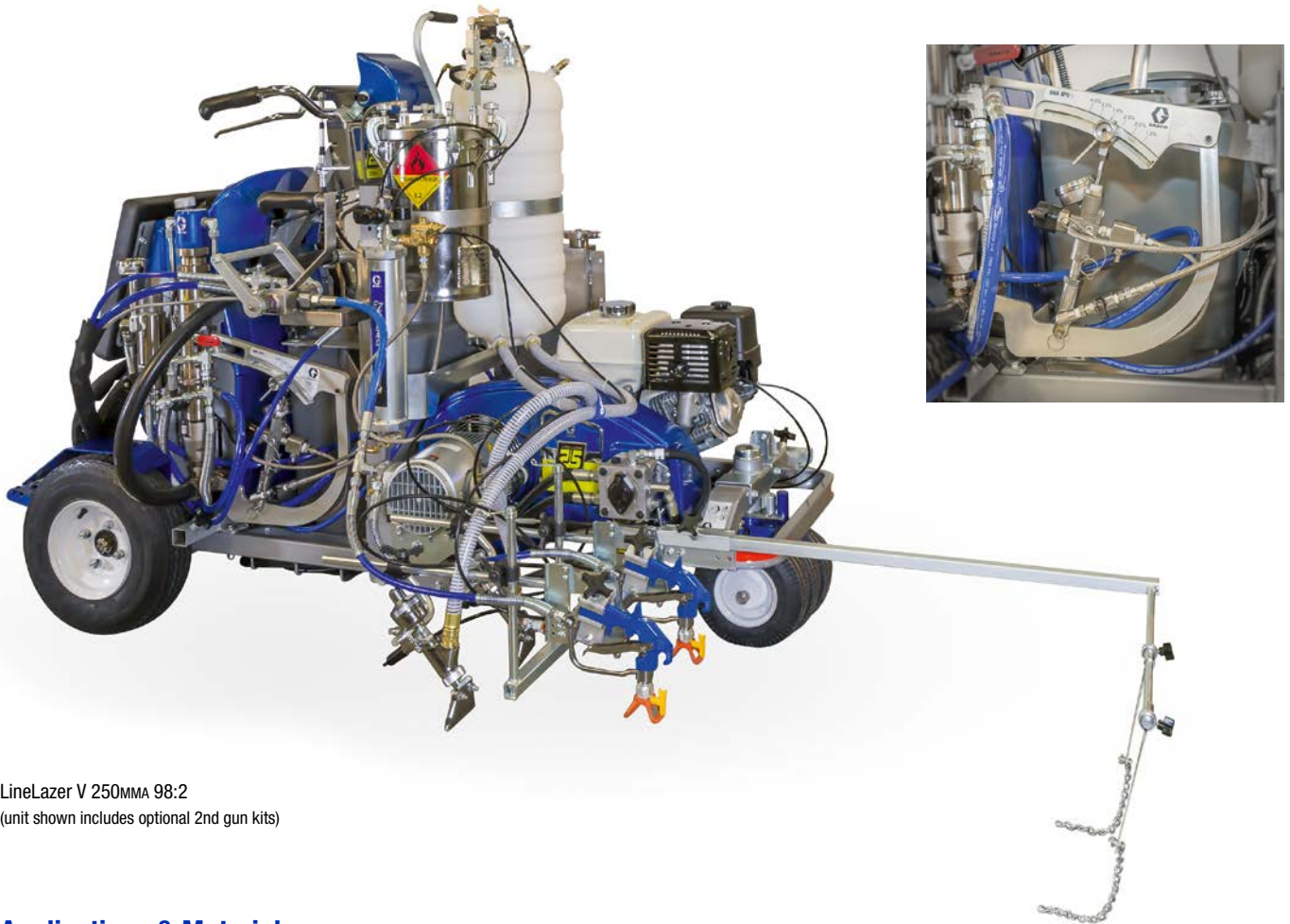

LineLazer V 250MMA 98:2  
(unit shown includes optional 2nd gun kits)

## ► Applications & Materials

Spraying 2-component 98:2 road markings has never been more reliable with LineLazer V 250MMA 98:2. Based upon the LineLazer V 250 range, this unit provides it all: built in 98:2 mixing capabilities and Ratio Assurance, on-board storage tanks and solvent flushing capabilities.

## ► Features & Benefits

### Automatic Paint Gun System

- Push button control for lower operator fatigue and accurate (skip-)lines
- Manual, semi- and automatic guns/mode

### Exclusive Stand-On Platform

- Integrated platform provides an ergonomic place for standing, great view and all-day comfort

### Self-Centering Front Wheel

- Eliminates one user interface for simpler operation
- Foam filled for stability

### EasyMark Gun Adjustment System

- Simple guide mark system
- Easy gun on/off, front/back
- Perfect gun set up every time

### Pressurized Bead System

- Installed and ready to go
- Ensures proper bead flow and paint penetration

### Exclusive 98:2 Mixing System

- On-Board storage tanks for MMA, BPO and solvent
- Exclusive hard-connect MMA and BPO pump design
- Engineered for superior ratio control, from 1.5 to 4.0%
- Integrated mix hose for consistency in material mixing
- Ratio assurance system and mix-manifold for outstanding performance

### 57 Liter MMA Hopper

- Extended striping time with large capacity hopper along with 7 Liter of BPO pressure pot

### Solvent Flush System

- 7 Liter solvent reservoir connected to an endurance piston pump provides pressurized flushing capability of manifold, hose assembly and gun

Ratio Assurance System

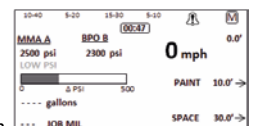

See page 45 for more detail



# Specifications

UNITS - EPOWER SERIES



LineLazer ES 1000

LineLazer V ES 2000

LineLazer V ES 2000



SPECIFICATIONS			
Part Number – 1 mech gun	25M228	25N553	-
Part Number – 2 mech guns	-	25N561	-
Part Number – 1 auto gun	-	-	25N554
Part Number – 1 auto + 1 mech gun	-	-	25N657
Part Number – 2 auto guns	-	-	25N562
Max. Tip Size – 1 gun	0.025"	0.033"	0.033"
Max. Tip Size – 2 guns	-	0.025"	0.025"
Max. Flow – l/min. (gpm)	2.3 (0.6)	4.1 (1.1)	4.1 (1.1)
Max. Pressure – bar (PSI)	227 (3300)	227 (3300)	227 (3300)
Battery Power – Volt (Ah)	12V (100Ah Deep Cycle AGM)	2x 12V (100Ah Deep Cycle AGM)	2x 12V (100Ah Deep Cycle AGM)
Weight – kg (lbs)	154 (340)	195 (430)	200 (440)
FEATURES			
LiveLook Display		✓	✓
Hydraulic Pressure gauge	✓		
SmartControl™	✓	✓	✓
FastFlush™	✓		
Endurance™ Pump	Mechanical	Mechanical	Mechanical
EZ Align™ System	✓	✓	✓
EasyMark System	✓	✓	✓
QuickSelect™ Gun Selector	Manual	Manual	Automatic + Manual
Rear-gun Mounted	✓	✓	✓
DualComfort™ Handle bar system	✓	✓	✓
LineDriver*	Optional	Optional	Optional
ProConnect	✓		
COMPOSITION			
Tips	LL5319	LL5319	LL5319
	LL5421	LL5421	LL5421
Guard	RAC V (243161)	RAC V (243161)	RAC V (243161)
Gun	Flex Plus™ (248157)	Flex Plus (248157)	Flex Plus (248157)
Hose	BlueMax™ II 1/4" x 15 m (249080)	BlueMax™ II 1/4" x 15 m (249080)	BlueMax™ II 1/4" x 15 m (249080)
Pump Filter – mesh	60 (243984)	50 (24V455)	50 (24V455)
Power Supply	1 x 12V - 100Ah battery with 230V inverter (EU, IT, DK, CH, UK - 30 cm cable set)	2 x 12V - 100Ah battery with 230V inverter (EU, IT, DK, CH, UK - 30 cm cable set)	2 x 12V - 100Ah battery with 230V inverter (EU, IT, DK, CH, UK - 30 cm cable set)
TSL	118 ml (238049)	118 ml (238049)	118 ml (238049)

\* See page 22-23 and 51 for more information on LineDriver.



# Specifications

UNITS - STANDARD SERIES



LineLazer 3400



LineLazer 130hs



LineLazer V 3900



SPECIFICATIONS				
Part Number – 1 mech gun	25M224	17H447	17H449	
Part Number – 2 mech guns	-	17H448	17H450	
Max. Tip Size – 1 gun	0.027"	0.037"	0.035"	
Max. Tip Size – 2 guns	-	0.029"	0.025"	
Max Flow – l/min. (gpm)	2.8 (0.75)	4.9 (1.3)	4.7 (1.25)	
Max. Pressure – bar (PSI)	227 (3300)	227 (3300)	227 (3300)	
Motor Rating – cm <sup>3</sup>	120	120	120	
Weight – kg (lbs)	72.5 (160)	119 (263)	104 (230)	
FEATURES				
LiveLook Display			✓	
Endurance Pump	Mechanical	Hydraulic	Mechanical	
AVRS		✓	✓	
EZ Align System		✓	✓	
EasyMark System	✓	✓	✓	
Quick Select Gun Selector		Manual	Manual	
Rear-gun Mounted		✓	✓	
DualComfort Handlebar System		✓	✓	
LineDriver*		Optional	Optional	
COMPOSITION				
Tips	LL5317	LL5319	LL5319	
	LL5319	LL5421	LL5421	
Guard	RAC V (243161)	RAC V (243161)	RAC V (243161)	
Gun	Flex Plus gun (248157)	Flex Plus gun (248157)	Flex Plus gun (248157)	
Hose	Hose 1/4" x 15 m (249080)	Hose 3/8" x 6.7 m (124884)	Hose 3/8" x 15 m (245225)	
Pump Filter	60 mesh (243984)	50 mesh (24V455)	50 mesh (24V455)	
Fuel Capacity - L (gal)	2.5 (0.66)	2.5 (0.66)	2.5 (0.66)	
TSL	118 ml (238049)	118 ml (238049)	118 ml (238049)	

\* See page 22-23 and 51 for more information on LineDriver.



## LineLazer V 5900

## LineLazer V 200hs

## LineLazer V 200dc



	17H454	17H459	-
	17H455	17H461	17Y231
	0.043"	0.047"	0.047"
	0.029"	0.033"	0.033"
	6.0 (1.6)	8.14 (2.15)	8.14 (2.15)
	227 (3300)	227 (3300)	227 (3300)
	160	200	200
	113 (250)	139 (306)	173 (381)
	✓	✓	✓
	Mechanical	Hydraulic	Hydraulic
	✓	✓	✓
	✓	✓	✓
	✓	✓	✓
	Manual	Manual	Manual
	✓	✓	✓
	✓	✓	✓
	Optional	Optional	Optional
	LL5319	LL5319	LL5319
	LL5421	LL5421	LL5421
	RAC V (243161)	RAC V (243161)	RAC V (243161)
	Flex Plus gun (248157)	Flex Plus gun (248157)	Flex Plus gun (248157)
	Hose 3/8" x 15 m (245225)	Hose 3/8" x 6.7 m (124884)	Hose 3/8" x 6.7 m (124884)
	50 mesh (24V455)	50 mesh (24V455)	50 mesh (24V455)
	3.6 (0.95)	3.6 (0.95)	3.6 (0.95)
	118 ml (238049)	118 ml (238049)	118 ml (238049)



# Specifications

UNITS - HP AUTOMATIC SERIES



LineLazer V 3900



LineLazer V 5900



LineLazer V 200hs



SPECIFICATIONS				
Part Number – 1 auto gun	17K577	17K580	17K582	
Part Number – 1 auto + 1 mech gun	17K638	17K636	17K637	
Part Number – 2 auto guns	17K579	17K581	17K583	
Part Number – 3 auto guns	-	-	-	
Max. Tip Size – 1 gun	0.035"	0.043"	0.047"	
Max. Tip Size – 2 guns	0.025"	0.029"	0.033"	
Max. Tip Size – 3 guns	-	-	-	
Max Flow – l/min. (gpm)	4.7 (1.25)	6.0 (1.6)	8.14 (2.15)	
Max. Pressure – bar (PSI)	227 (3300)	227 (3300)	227 (3300)	
Motor Rating – cm <sup>3</sup>	120	160	200	
Weight – kg (lbs)	109 (240)	121 (266)	146 (322)	
FEATURES				
LiveLook Display	✓	✓	✓	
Endurance Pump	Mechanical	Mechanical	Hydraulic	
AVRS	✓	✓	✓	
EZ Align System	✓	✓	✓	
EasyMark System	✓	✓	✓	
DualComfort Handlebar System	✓	✓	✓	
Quick Select Gun Selector	Automatic + Manual	Automatic + Manual	Automatic + Manual	
Rear-gun Mounted	✓	✓	✓	
LineDriver*	Optional	Optional	Optional	
COMPOSITION				
Tips	LL5319	LL5319	LL5319	
	LL5421	LL5421	LL5421	
Guard	RAC V (243161)	RAC V (243161)	RAC V (243161)	
Gun	Flex Plus gun (248157)	Flex Plus gun (248157)	Flex Plus gun (248157)	
Hose	Hose 3/8" x 15 m (245225)	Hose 3/8" x 15 m (245225)	Hose 3/8" x 6.7 m (124884)	
Pump Filter	50 mesh (24V455)	50 mesh (24V455)	50 mesh (24V455)	
Fuel Capacity - L (gal)	2.5 (0.66)	3.6 (0.95)	3.6 (0.95)	
TSL	118 ml (238049)	118 ml (238049)	118 ml (238049)	

\* See page 22-23 and 51 for more information on LineDriver.

## LineLazer V 200oc

## LineLazer V 250sps

## LineLazer V 250oc



-	17H466	-
-	-	-
17Y232	17H467	17H471
-	-	17H472
0.047"	0.055"	0.055"
0.033"	0.039"	0.039"
-	0.031"	0.031"
8.14 (2.15)	9.5 (2.5)	9.5 (2.5)
227 (3300)	227 (3300)	227 (3300)
200	390 - Electric Start	390 - Electric Start
180 (397)	302 (666)	341 (752)
✓	✓	✓
Hydraulic	Hydraulic	Hydraulic
✓	✓	✓
✓	✓	✓
✓	✓	✓
✓	✓	✓
Automatic + Manual	Automatic	Automatic
✓	✓	✓
Optional	Self Propelled System	Self Propelled System
LL5319	LL5321	LL5321
LL5421	LL5425	LL5425
	LL5627	LL5627
RAC V (243161)	RAC V (243161)	RAC V (243161)
Flex Plus gun (248157)	Flex Plus gun (248157)	Flex Plus gun (248157)
Hose 3/8" x 6.7 m (124884)	Hose 3/8" x 3.6 m (191239)	Hose 3/8" x 3.6 m (191239)
	Hose 1/4" x 2 m (245798)	Hose 1/4" x 2 m (245798)
50 mesh (24V455)	50 mesh (24V455)	50 mesh (24V455)
3.6 (0.95)	5.3 (1.4)	5.3 (1.4)
118 ml (238049)	118 ml (238049)	118 ml (238049)

# Specifications

UNITS - HP REFLECTIVE SERIES



LineLazer V 200hs



LineLazer V 200bc



SPECIFICATIONS			
Part Number – PBS 1 auto gun	17J964	-	
Part Number – PBS 2 auto guns	17K585	17Y233	
Part Number – PBS 3 auto guns	-	-	
Part Number – PBS 1 mech gun	17H460	-	
Part Number – PBS 2 mech gun	-	17Y648	
Max. Tip Size – 1 gun	0.047"	0.047"	
Max. Tip Size – 2 guns	0.033"	0.033"	
Max. Tip Size – 3 guns	-	-	
Max Flow – l/min. (gpm)	8.14 (2.15)	8.14 (2.15)	
Max. Pressure – bar (PSI)	227 (3300)	227 (3300)	
Motor Rating – cm <sup>3</sup>	200	200	
Weight – kg (lbs)	189 (417)	223 (492)	
FEATURES			
LiveLook Display	✓	✓	
Endurance Pump	Hydraulic	Hydraulic	
AVRS	✓	✓	
EZ Align System	✓	✓	
EasyMark System	✓	✓	
Quick Select Gun Selector	Automatic + Manual	Automatic + Manual	
Rear-gun Mounted	✓	✓	
Bead Tank	1 Bead Tank	1 Bead Tank	
Bead Guns	17J964 – 1 bead gun		
	17K585 – 2 bead guns	17Y233 - 2 bead guns	
	17K460 – 1 bead gun	17Y648 - 2 bead guns	
DualComfort Handlebar System	✓	✓	
LineDriver *	Optional	Optional	
COMPOSITION			
Tips	LL5319	LL5319	
	LL5421	LL5421	
Bead Nozzle	.234 (238666)	.234 (238666)	
	.281 (238664)	.281 (238664)	
Guard	RAC V (243161)	RAC V (243161)	
Gun	Flex Plus gun (248157)	Flex Plus gun (248157)	
Hose	Hose 3/8" x 6.7 m (124884)	Hose 3/8" x 6.7 m (124884)	
Pump Filter	50 mesh (24V455)	50 mesh (24V455)	
Fuel Capacity - L (gal)	3.6 (0.95)	3.6 (0.95)	
TSL	118 ml (238049)	118 ml (238049)	

\* See page 22-23 and 51 for more information on LineDriver.

\*\* Part 17J951 has one PBS tank and 17H469 has two PBS tanks



**LineLazer V 250sps**

**LineLazer V 250oc**



	17H468	-
	17J951 + 17H469**	17H473
	-	17H474
	-	-
	-	-
	0.055"	0.055"
	0.039"	0.039"
	0.031"	0.031"
	9.5 (2.5)	9.5 (2.5)
	227 (3300)	227 (3300)
	390 - Electric Start	390 - Electric Start
	352 (778)	392 (864)
	✓	✓
	Hydraulic	Hydraulic
	✓	✓
	✓	✓
	Automatic	Automatic
	✓	✓
	1 bead tank (17H468)	2 bead tanks
	1 bead tank (17J951)	
	2 bead tanks (17H469)	
	17H468 - 1 bead gun	17H473 - 2 bead guns
	17J951 - 2 bead guns	17H474 - 3 bead guns
	17H469 - 2 bead guns	
	Self Propelled System	Self Propelled System
	LL5321	LL5321
	LL5425	LL5425
	LL5627	LL5627
	.234 (238666)	.234 (238666)
	.281 (238664)	.281 (238664)
	RAC V (243161)	RAC V (243161)
	Flex Plus gun (248157)	Flex Plus gun (248157)
	Hose 3/8" x 3.6 m (191239)	Hose 3/8" x 3.6 m (191239)
	Hose 1/4" x 2 m (245798)	Hose 1/4" x 2 m (245798)
	50 mesh (24V455)	50 mesh (24V455)
	5.3 (1.4)	5.3 (1.4)
	118 ml (238049)	118 ml (238049)

# Specifications

UNITS - 2-COMPONENT

LineLazer V 200MMA 1:1



LineLazer V 250MMA 98:2

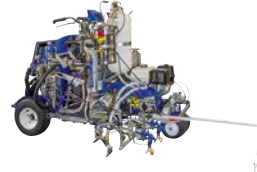

SPECIFICATIONS		
Part Number - PBS 1 Auto Gun	17Y234	17G589
Part Number - PBS 2 Auto Guns	17Y513	-
Max. Tip Size – 1 gun	0.047"	0.055"
Max. Tip Size – 2 guns	0.033"	0.039"
Max. Tip Size – 3 guns	-	0.031"
Max Flow – l/min. (gpm)	8.14 (2.15)	9.5 (2.5)
Max. Pressure – bar (PSI)	227 (3300)	207 (3000)
Motor Rating – cm <sup>3</sup>	200	390 - Electric Start
Weight – kg (lbs)	251 (554)	405 (893)
FEATURES		
LiveLook Display	✓	✓
MMA Pump	Hydraulic	Hydraulic
BPO Pump	-	Hydraulic
Mix Ratio Assurance System	Hydraulic 1:1 Proportioner	✓
Mixing System	Air-Purge Fusion gun with internal mixing	Mix Hose
Solvent Tank + Pump	-	On-Board
AVRS	✓	✓
EasyMark System	✓	✓
Quick Select Gun Selector	Automatic + Manual	Automatic
Rear-gun Mounted	✓	✓
Bead Tank	1 bead tank	1 bead tank
Bead Guns	1 bead gun	1 bead gun
DualComfort Handlebar System	✓	-
LineDriver*	Optional	Self Propelled System
COMPOSITION		
Tips	286427	LL5321
	286631	LL5425
	286835	LL5627
Bead Nozzles	.234 (238666)	.234 (238666)
	.281 (238664)	.281 (238664)
Guard	RAC V (243161)	RAC V (243161)
Gun	Fusion gun (25E471)	HD Blue Texture gun (289605)
Hose	Hose 3/8" x 6.7 m (124884)	MMA Hose 3/8" x 6.7 m (124884)
	-	BPO Hose 1/4" x 5.8 m (17K367)
	50 mesh (24V455)	Solvent Hose 1/4" x 7.6 m (277481)
Mix Hose	-	Hose 3/8" x 50 cm (17H058)
Whip Hose	-	Hose 1/4" x 50 cm (249149)
Fuel Capacity - L (gal)	3.6 (0.95)	5.3 (1.4)
TSL	118 ml (238049)	118 ml (238049)

\* See page 22-23 and 51 for more information on LineDriver.





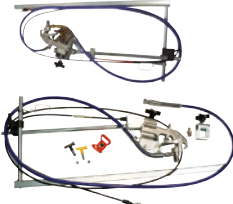

# LineLazer™ Accessories

PART NUMBER	DESCRIPTION
<b>GUN AND HOSE KITS</b>	
	248157 FLEXPLUS STRIPING GUN WITH LL5319 TIP
	245225 LINELAZER HOSE WITH E-NICKEL FITTINGS. 3/8" X 15 M - 227 BAR
	245798 LINELAZER HOSE WITH E-NICKEL FITTINGS. 1/4" X 2 M - 227 BAR (2 <sup>ND</sup> GUN HOSE)
	249080 COUPLED HOSE, 1/4" X 15 M (LINELAZER ES, 3400)
	124884 LINELAZER HOSE WITH E-NICKEL FITTINGS, 3/8" X 6.7 M - 227 BAR (LINELAZER IV & V 130HS, 200HS, 250MMA 98:2)
	191239 LINELAZER HOSE WITH E-NICKEL FITTINGS, 3/8" X 3.6 M - 227 BAR (LINELAZER IV & V 250SPS + 250DC)
<b>PAINT GUN KITS</b>	
	25A676 COMPLETE KIT FOR ADDING 2 <sup>ND</sup> MECHANICAL GUN (LINELAZER 130HS)
	25A491 COMPLETE KIT FOR ADDING 2 <sup>ND</sup> MECHANICAL GUN (LINELAZER V 3900/5900/200, ES)
	25A673 COMPLETE KIT WITH SOLENOID FOR ADDING 2 <sup>ND</sup> AUTO GUN (LINELAZER V HP AUTOMATIC 3900/5900/200)
	25A492 COMPLETE KIT WITHOUT SOLENOID FOR ADDING 2 <sup>ND</sup> AUTO GUN (LINELAZER V HP AUTOMATIC 3900/5900/200)
	17K791 COMPLETE KIT FOR ADDING EXTRA AUTO GUN (LINELAZER V 250SPS+DC)
	287553 COMPLETE KIT FOR ADDING 2 <sup>ND</sup> GUN (LINELAZER III 3900/5900 – LINELAZER IV)
	24M679 COMPLETE KIT FOR ADDING 2 <sup>ND</sup> GUN (LINELAZER IV 250)
	24P930 COMPLETE KIT FOR ADDING 3 <sup>RD</sup> OR 4 <sup>TH</sup> GUN (LINELAZER IV 250)
	24G778 PAINT GUN STENCIL KIT (LL250) INCLUDES: (1) PAINT GUN AND 1/4 IN X 15M HOSE AND MOUNTING BRACKETS
<b>2-COMPONENT</b>	
	25N796 COMPLETE KIT FOR ADDING 2 <sup>ND</sup> FUSION AND BEAD GUN (LINELAZER V 200MMA 1:1)
	289605 HD BLUE TEXTURE GUN (LINELAZER V 250MMA 98:2)
	17K367 BPO HOSE 1/4" X 5.8 M, METAL BRAIDED (LINELAZER V 250MMA 98:2)
	277481 SOLVENT HOSE 1/4" x 7.6 M
	17H058 MIX HOSE, 50 CM, 40 CM STATIC MIXING ELEMENTS (LINELAZER V 250MMA 98:2)
	17K319 COMPLETE KIT FOR ADDING 2 <sup>ND</sup> AUTO GUN (EXCLUDING BEAD GUN KIT) (LINELAZER V 250MMA 98:2)
	17H095 MANIFOLD MIXER, COMPLETE (LINELAZER V 250MMA 98:2)
	17H093 BPO SLAVE PUMP KIT (LINELAZER V 250MMA 98:2)

# LineLazer™ Accessories

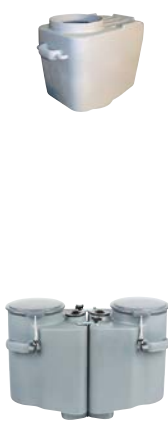
	PART NUMBER	DESCRIPTION
<b>LINELAZER POINTERS</b>		
	277062	SHORT POINTER GUIDE 60 CM
	277063	LONG POINTER GUIDE 100 CM
	24N162	ADJUSTABLE POINTER GUIDE 100 CM (LINELAZER 250)
	25A620	RETRACTABLE POINTER 100 CM (LINELAZER V 130/3900/5900/200, ES)
	24Y511	5-PACK HOSE REPLACEMENT FOR 25A620 RETRACTABLE POINTER
	17P782	LAZERGUIDE 1700, GREEN DOT, WITHOUT BATTERY KIT (LINELAZER ES)
	25A530	LAZERGUIDE 1700, GREEN DOT, WITHOUT BATTERY KIT (LINELAZER V HP AUTO 3900/5900/200)
	25A691	LAZERGUIDE 1700, GREEN DOT, WITHOUT BATTERY KIT (LINELAZER 250)
	17T543	LAZERGUIDE 2000, GREEN LINE, WITHOUT BATTERY KIT (LINELAZER ES)
	17T540	LAZERGUIDE 2000, GREEN LINE, WITHOUT BATTERY KIT (LINELAZER V HPAUTO 3900/5900/200)
	17W270	LAZERGUIDE 2000, GREEN LINE, WITHOUT BATTERY KIT (LINELAZER 250)
	17U800	LAZERGUIDE 2000, GREEN LINE, WITH BATTERY/CHARGER KIT (LINELAZER 3400)
	17T541	LAZERGUIDE 2000, GREEN LINE, WITH BATTERY/CHARGER KIT (LINELAZER V STANDARD 3900/5900/200)
	17T545	LAZERGUIDE 2000, GREEN LINE, WITH BATTERY/CHARGER KIT (LINELAZER IV)
	17V405	LAZERGUIDE 3000, BIG GREEN DOT, WITHOUT BATTERY KIT (LINELAZER V HP AUTO 5900/200)
	17T542	LAZERGUIDE 3000, BIG GREEN DOT, WITHOUT BATTERY KIT (LINELAZER 250)
<b>PAINT HOPPERS</b>		
	17P444	HOPPER 55 L (LINELAZER ES 1000, 3400)
	241104	HOPPER 55 L (LINELAZER 130/3900/5900/200)
	25N710	HOPPER 55 L (LINELAZER V ES 2000)
	278452	HOPPER 95 L HIGH CAPACITY (LINELAZER IV & V 250sps)
	278720	HOPPER 55 L - 1 PIECE (SPLIT DESIGN FOR LINELAZER IV & V 250dc & 250MMA 98:2)
	24V781	DUAL PLASTIC HOPPER COVER KIT - 2 PIECES (LINELAZER IV & V 250dc)
	25N622	DUAL 38 L HOPPER COMPLETE KIT (LINELAZER V 200DC, 200MMA 1:1) 2 HOPPERS, 2 COVERS, 2 GROMMETS AND SUCTION TUBE EXTENSIONS
	24V782	DUAL 55 L HOPPER COMPLETE KIT (LINELAZER IV & V 250dc) 2 HOPPERS, 2 COVERS, 2 GROMMETS AND ALL HARDWARE
	25N603	DUAL PAINT BUCKET HOLDER (LINELAZER 200DC) FOR USING TWO STANDARD PAINT BUCKETS
	24U244	DUAL PAINT BUCKET HOLDER (LINELAZER 250DC) FOR USING TWO STANDARD PAINT BUCKETS

# LineLazer™ Accessories

	PART NUMBER	DESCRIPTION
<b>PRESSURIZED BEAD SYSTEM</b>		
	25R271	PBS CLOSED COMPRESSOR KIT (LINELAZER V 200)
	25R272	PBS CLOSED COMPRESSOR KIT (LINELAZER V 250)
	25R268	PBS 1-GUN KIT (LINELAZER V 200)
	25R267	PBS 2-GUN KIT (LINELAZER V 200)
	25R270	PBS 1-GUN KIT (LINELAZER V 250)
	25R269	PBS 2-GUN KIT (LINELAZER V 250)
	16R963	PBS EXTRA BEAD GUN KIT (LINELAZER IV & V 200HS/LINELAZER IV & V 250)
	238957	HAND BEAD STENCIL KIT (USE WITH THE EZ BEAD PRESSURIZED DISPENSING SYSTEM ONLY) INCLUDES: (1) BEAD GUN, (2) 3/4" X 7.5 M CLEAR HOSES, .234" / .35 DEGREE TIP, 30 CM EXTENSION TUBE AND MOUNTING BRACKETS
	16U439	PBS BEAD TANK KIT
	17V103	BEAD GUN NOZZLE .170
	238663	BEAD GUN NOZZLE .203
	238666	BEAD GUN NOZZLE .234
	238664	BEAD GUN NOZZLE .281
	238665	BEAD GUN NOZZLE .344
	243668	BEAD GUN NOZZLE .420
<b>GRAVITY BEAD SYSTEM</b>		
	24N267	30 CM EZ BEAD DISPENSER KIT (LINELAZER IV & V 250SPS & DC)
	24M641	15 CM EZ BEAD DISPENSER KIT (LINELAZER IV & V 250SPS & DC)
	24M838	15 CM (x2) EZ BEAD DISPENSER KIT (LINELAZER IV & V 250SPS & DC)
	24N265	30 CM EZ BEAD DISPENSER KIT (LINELAZER ES, IV & V)
	24Z727	30 CM EZ BEAD DISPENSER KIT (LINELAZER 3400)
	277065	15 CM EZ BEAD DISPENSER KIT (LINELAZER IV & V)
	24Z726	15 CM EZ BEAD DISPENSER KIT (LINELAZER 3400)
	277064	15 CM (x2) EZ BEAD DISPENSER KIT (LINELAZER IV & V)
	277067	15 CM EZ BEAD DISPENSER WITH HOSE AND WIND DEFLECTOR (LINELAZER ES, IV & V)
	245516	30 CM EZ BEAD DISPENSER WITH HOSE AND WIND DEFLECTOR (LINELAZER ES, IV & V)
	277066	EZ BEAD WIND DEFLECTORS ALUMINUM - 15 CM (x6)
	245520	WIND DEFLECTOR 3x/PACK (30 CM)



# LineLazer™ Accessories

PART NUMBER	DESCRIPTION
<b>WHEEL REPLACEMENTS</b>	
113479	FRONT WHEEL REPLACEMENT (LINELAZER IV & V 250) (PNEUMATIC)
16W284	FRONT WHEEL REPLACEMENT (LINELAZER IV & V 250) (FOAM FILLED)
17R436	3-WHEEL FRONT WHEEL CONVERSION KIT (LINELAZER IV & V 250sps/250dc/250MMA 98:2)
249083	TURF WHEEL KIT (LINEDRIVER, LINELAZER IV & V 250) (2 WHEELS)
249082	TURF WHEEL KIT (LINELAZER IV & V 130/3900/5900/200) (2 WHEELS) (NOT FOR LINELAZER IV AUTO-LAYOUT)
<b>EXTRA ACCESSORIES</b>	
24Z724	SECOND BATTERY KIT WITH CABLES (LINELAZER ES)
25C772	BATTERY WITHOUT CABLES (LINELAZER ES)
24X370	BATTERY WITHOUT CABLES (LINELAZER V HP AUTOMATIC 3900/5900/200)
115753	BATTERY WITHOUT CABLES (LINELAZER 250)
25A526	BATTERY CONVERSION KIT FOR LINELAZER V STANDARD 3900/5900/200 (BATTERY, CHARGER BOARD, HARDWARE)
25A932	HP AUTO CONVERSION KIT FROM LINELAZER V STANDARD TO LINELAZER V HP AUTO (3900/5900/200 ONLY) (BATTERY, ALL CONTROL BOARDS, SOLENOID, GUN CABLE, HARDWARE)
25N790	HP AUTO CONVERSION KIT LINELAZER V STANDARD TO HP AUTO (3900/5900/200 SERIES C ONLY)
25N711	HP AUTO CONVERSION KIT LINELAZER V STANDARD TO HP AUTO (ES 2000 ONLY)
287626	50 CM STRIPING RAMP WITH 2 HEADS
25N787	LINEDRIVER HITCH KIT (LINELAZER ES/130/200/3900/5900)
16P015	SAFETY CONE HOLDER
24N600	SAFETY CONE HOLDER WITH SUPPORT BRACKET
17R472	LED LIGHT KIT (LINELAZER ES)
17R473	LED LIGHT KIT (LINELAZER V HP AUTOMATIC 3900/5900/200)
24M598	LED LIGHT KIT (LINELAZER IV & V 250)
249081	ADJUSTABLE SPRAY SHIELD KIT FOR LINELAZER
17K356	2 <sup>ND</sup> PUMP KIT LL V 250sps (COMPLETE PUMP KIT, HARDWARE, HOSES AND DUAL HOPPER SYSTEM)
25N653	FRONT WEIGHT KIT (LINELAZER V 3900/5900/130HS/200HS/200DC/200MMA 1:1)



# LineLazer™ Accessories

PART NUMBER	DESCRIPTION
<b>MAINTENANCE FLUIDS</b>	
238049	TSL BOTTLE 118 ML
206994	TSL BOTTLE 250 ML
206995	TSL BOTTLE 1 L
206997	TSL BOTTLE 1 L (X12)
206996	TSL BOTTLE 3.8 L
206998	TSL BOTTLE 3.8 L (X4)
253574	PUMP ARMOR 1 L
245133	PUMP ARMOR 3.8 L
207428	HYDRAULIC FLUID 3.8 L
169236	HYDRAULIC FLUID 20 L



# LineDriver™ Units & Accessories



LineDriver 160

▶ Available Units\*

	PART NUMBER	Motor Engine cc (hp)	Fuel Capacity L (gal)	Weight kg (lb)
LineDriver 160	262004	160 cm <sup>3</sup>	3.6 (0.95)	120 (266)
LineDriver HD 200	262005	200 cm <sup>3</sup>	3.6 (0.95)	125 (277)
LineDriver ES	25N556	4x 6V DEEP CYCLE AGM 225AH	-	250 (550)

\*All LineDriver units can be used on the LineLazer, ThermoLazer and the HP GrindLazer

**PART NUMBER**      **DESCRIPTION**

LINE DRIVER



245321      LINEDRIVER HITCH KIT\*\*  
(GRINDLAZER HP DC89 G/1013 G (DCS)/DC1021 G (DCS))

25N787      LINEDRIVER HITCH KIT\*\*  
(LINE LAZER ES/130/200/3900/5900)

25R505      LINEDRIVER HITCH KIT\*\*  
(THERMOLAZER 300TC/PROMELT)



249083      TURF WHEEL KIT LINEDRIVER



245343      BATTERY KIT FOR LINEDRIVER 160/200 (AUXILIARY)

\*\*Includes ball 116913 and washer 110947



# RoadLazer RoadPak™



# RoadPak™ and RoadPak™ HD System

## Truck Mount Striping Systems



RoadPak HD System



RoadPak 1-Pump System



RoadPak 2-Pump System

### ► Applications & Materials

RoadPak System, a complete modular setup to comply with your road striping situation. Based upon a RoadPak Module with 1 or 2 pumps, the RoadPak system is delivered in 12 different options or can be compiled to fulfil your striping needs. The RoadPak HD System offers a whole new level with double the output of RoadPak and the ability to stripe with up to 5 or more guns. This is a high-productivity striping machine which is delivered in 4 different options or can be compiled to fulfil your striping needs.

### ► Features & Benefits Includes all RoadPak System Features PLUS:

#### Heavy-Duty RPS 2900 Hydraulic System

- Proven performer built off of our highly reliable GH™ 833 then optimized for road striping
- No-stall design provides the productivity you get from Graco designed products
- Maximum pressure of 200 bar

#### Displacement Pump System

- Graco's displacement pumps have delivered outstanding results in pumping striping paint for over 20 years
- Prime valve allows you to recirculate paint keeping it mixed and ready to go

#### Heavy-Duty Modular Frame System

- Small frame size allows it to fit almost anywhere – from the back of a pickup or flatbed truck to the bed of a utility vehicle
- Heavy-duty steel frame is built to last
- Simple to add options you want in minutes – optimizing your striping system

#### Heavy-Duty Compressor

- 6.9 bar at 13.1 cfm
- Accumulation Tank for paint and bead guns (20 litres on RoadPak HD to support up to 5 paint and 5 bead guns)

#### Kohler® Power

- RoadPak: 19 hp Kohler engine
- RoadPak HD: 26.5 hp EFI Kohler engine
- Over 15 years of reliable experience

#### 1 or 2-Pump RoadPak System

- RoadPak is delivered as a 1-or 2-pump system allowing single or dual colour option (RoadPak HD always 2 pumps)
- Step up to RoadPak HD to double your output up to 37.8 litre per minute
- Optionally expand your system with extra pumps for other colours



# RoadView HD Camera System

## ► RoadView HD Camera System

Turn your RoadPak into a single user vehicle with the RoadView HD Camera System. It allows single users to do the jobs once reserved for the “big trucks” – all from the inside comfort of the striping vehicle.



The camera mounts on the gun arm and travels from one side of the truck to the other without adjustments. The view of the camera allows users to see from behind the paint and bead guns, which is very similar to the view from a walk behind unit. A quick disconnect electrical system for the camera allows safe storing when not using and also allows you to switch between the standard 16 mm or optional 6 mm camera. The 16 mm camera provides a “farther-out” view, while the 6 mm camera option is a great choice for those striping contractors who prefer a “closer-in” view.

It's easy to match up old stripes with the remote, hand activated Switch System. With a push of your thumb, you control the start and stop on those tough restripe jobs.



6 mm Camera

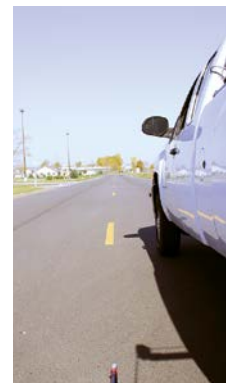

16 mm Camera



## ► Specifications

- LCD Monitor measurement 9 inch Diagonal: 22.9 cm x 14.5 cm x 3.2 cm
- Ratio: 16:9 Wide TFT Screen
- Camera (16 mm): 6.4 cm x 5 cm x 5 cm
- Power Source: DC 12V
- Operating Temperature: -42°C to 65°C



# RoadPak™ Advanced Controller

## ▶ RoadPak Advanced Controller

The RoadPak Advanced Controller offers an operator simple to use controls that will make striping road jobs easy. Check your Roadpak, program skip lines, measure distances, all from within the comfort of the vehicle.



## ▶ Pattern Capability

### Road Markings

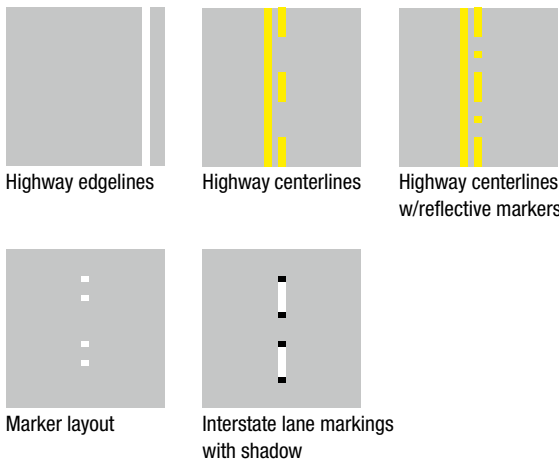

### Airport Patterns

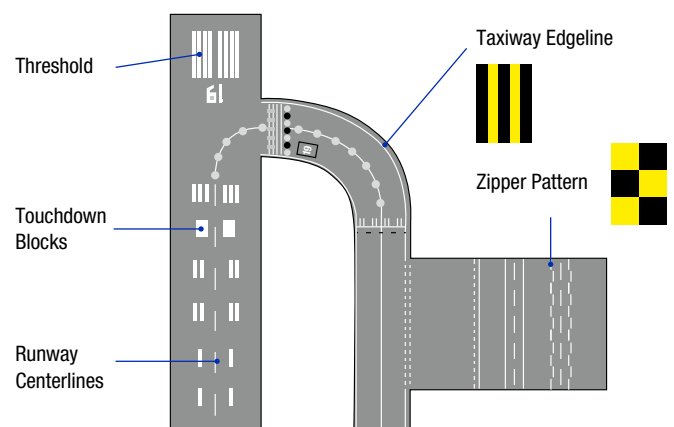

## ▶ Features

### Main Screen with Pattern Preview

Main screen provides all necessary information while striping. Pattern preview provides a quick visual of colours and patterns selected.

### Preset Buttons

User defined preset buttons allow you to adjust the main screen to your personal needs.

### 4-Axis Joy-Stick

Easily move through menus and settings and changing or (de)activating parameters.

### 5-Gun Toggle Control

Toggle switch for all 5 guns allows for quick activation and control.

### Proof-of-Job

Included with Export Capabilities to download jobsite data to USB stick for "proof-of-job".

### Pattern Ability

Wide variety of gun activation and pattern capability:

- o Manual
- o Automatic
- o Semi-Automatic
- o Zipper Pattern
- o Solid & Skip lines
- o Shadow and Contrast lines

# RoadLazer RoadPak™

---



# RoadPak™ Mount System

## ► RoadPak Mount System

Install your RoadPak on almost any vehicle using a Single-Hitch Mounting Frame or a Slide-In Mounting Frame. The Mounting Frame allows you to attach your gun arm to your vehicle for easy left/right spraying but comes in two easy-to-install options depending on the vehicle on which you want to install your RoadPak.

## ► Mount Systems

### Slide-In Mounting Frame



The Slide-in Mounting Frame allows many different vehicles to perform your road striping jobs.

### Single-Hitch Mounting Frame



A Single-Hitch Mounting Frame allows you to use your existing vehicle with little or no modifications to carry your gun bar arm with the RoadPak System.

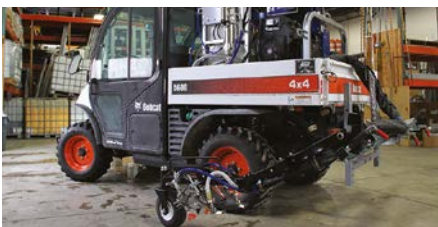

# Specifications

ROADPAK

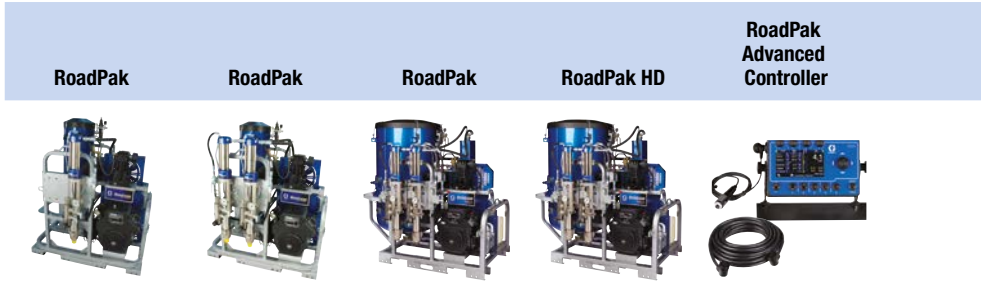

SPECIFICATIONS	RoadPak	RoadPak	RoadPak	RoadPak HD	RoadPak Advanced Controller
Part Number	25M701	25M703	25M704	25M706	25M711
Pumps	1	2	2	2	-
Guns	-	-	-	-	-
Engine - hp	19	19	19	26.5	-
Max. Flow - lpm (gpm)	18.9 (5)	18.9 (5)	18.9 (5)	37.8 (10)	-
Bead Tank - kg (lb)	204 (450)	204 (450)	612 (1350)	612 (1350)	-

ROADPAK SYSTEM READY-TO-STRIPE						
1	RPS – OPTION 1					
		25D268	✓			✓
2	RPS – OPTION 2					
		25D269	✓			✓
3	RPS – OPTION 3					
		25D270	✓			✓
4	RPS – OPTION 4					
		25D271	✓			✓
5	RPS – OPTION 5					
		25D272		✓		✓
6	RPS – OPTION 6					
		25D273		✓		✓
7	RPS – OPTION 7					
		25D274		✓		✓
8	RPS – OPTION 8					
		25D275		✓		✓
9	RPS – OPTION 9					
		25D276			✓	✓
10	RPS – OPTION 10					
		25D277			✓	✓
11	RPS – OPTION 11					
		25D278			✓	✓
12	RPS – OPTION 12					
		25D279			✓	✓
13	RPS – OPTION 13					
		25D280			✓	✓
14	RPS – OPTION 14					
		25D281			✓	✓
12	RPS – OPTION 15					
		25D282			✓	✓
16	RPS – OPTION 16					
		25D283			✓	✓

\* The adjustable gun arm beam (24G630) is included by default



RoadPak Gun Arm	RoadPak Gun Arm	RoadPak HD Gun Arm	Slide-in Mounting Frame	RoadView HD Camera System	Simple Guide System	Gun Lift Winch Kit	Rear Seat Kit	Steerable Carriage
-----------------	-----------------	--------------------	-------------------------	---------------------------	---------------------	--------------------	---------------	--------------------



	25M708	25M709	25M710	24G627	24G633	24G634	25M713	25M716	25M712
	1	2	2	-	-	-	-	-	-
	2	2	3	-	-	-	-	-	-
	-	-	-	-	-	-	-	-	-
	-	-	-	-	-	-	-	-	-
	-	-	-	-	-	-	-	-	-

	✓			✓		✓			
	✓			✓	✓	✓			
	✓			✓		✓	✓	✓	✓
	✓			✓	✓	✓	✓	✓	✓
		✓		✓		✓			
		✓		✓	✓	✓			
		✓		✓		✓	✓	✓	✓
		✓		✓	✓	✓	✓	✓	✓
		✓		✓		✓			
		✓		✓	✓	✓			
		✓		✓		✓	✓	✓	✓
		✓		✓	✓	✓	✓	✓	✓
			✓	✓		✓	✓		
			✓	✓	✓	✓	✓		
			✓	✓		✓	✓	✓	✓
			✓	✓	✓	✓	✓	✓	✓

# RoadPak™ Accessories

**PART  
NUMBER**                      **DESCRIPTION**

## CHOOSE YOUR ROADPAK MODULE\*



25M701	ROADPAK MODULE - 1-PUMP - 18.9 LPM - 204 KG BEAD TANK
25M703	ROADPAK MODULE - 2-PUMP - 18.9 LPM - 204 KG BEAD TANK
25M704	ROADPAK MODULE - 2-PUMP - 18.9 LPM - 612 KG BEAD TANK
25M706	ROADPAK HD MODULE - 2-PUMP - 37.8 LPM - 612 KG BEAD TANK

\* See OEM section for modules without bead tanks

## CHOOSE YOUR GUN ARM MOUNTING SYSTEM



24G627	SLIDE-IN MOUNTING FRAME
24G626	SINGLE HITCH MOUNTING FRAME

## CHOOSE YOUR GUN ARM



25M708	1-PUMP, 2-GUN ROADPAK GUN ARM (2x paint guns, 2x bead guns, all hoses)
25M709	2-PUMP, 2-GUN ROADPAK GUN ARM (2x paint guns, 2x bead guns, all hoses)
25M710	2-PUMP, 3-GUN ROADPAK GUN ARM (3x paint guns, 3x bead guns, all hoses, stabilizing wheel and longer gun mount bar)
25D932	2-PUMP, 3-GUN ROADPAK GUN ARM (3x paint guns, all hoses, stabilizing wheel and longer gun mount bar) -> No bead guns
25D642	ROADPAK ADDITIONAL GUN KIT (ROADPAK AS OF 2018) Kit comes with a dual acting paint gun, dual acting bead gun, the hardware and hoses to connect the guns to the system.
24G630	ADJUSTABLE GUN ARM BEAM



# RoadPak™ Accessories

**PART  
NUMBER**                      **DESCRIPTION**

## CHOOSE YOUR ROADPAK MAJOR ASSEMBLY ADD-ONS



25M711                      ROADPAK ADVANCED CONTROLLER



24G633                      ROADVIEW HD CAMERA SYSTEM

24G771                      6 MM CAMERA KIT  
Kit includes a 6mm camera. Cable included to connect to monitor (closer in view)



24H555                      16 MM CAMERA KIT  
Kit includes a 16 mm camera. Cable included to connect to monitor (farther out view)



24G634                      SIMPLE GUIDE SYSTEM

241880                      DYNAMIC FRONT ARTICULATING POINTER  
Dynamic front articulating pointer. Excellent for those hard-to-stripe curves

## CHOOSE YOUR ROADPAK MODULE ACCESSORIES



25M716                      REAR SEAT KIT  
Seat with safety belt, base mounting plate, bracket for controller

25M712                      STEERABLE CARRIAGE KIT  
Kit has the steerable carriage controller, gun arm actuator and mounting brackets



17U930                      LAZERGUIDE 3000  
Long-Line Laser for RoadPak



25M713                      GUN LIFT/WINCH KIT  
Kit comes with a winch, the mounting brackets, and the wiring to connect it to a RoadPak system. The winch can easily be moved from one side of the vehicle to the other.



24G766                      RPS 2900 COMPLETE PUMP KIT  
Kit has an RPS 2900 Pump with all the hydraulic lines and fasteners needed to mount to the RoadPak system.



25D643                      PRESSURE BALANCE KIT  
To balance pressure between two pumps pumping same colour. Provides the same pressure to each gun.



24G769                      125 LITRE ROTOMOLD PAINT TANK  
Kit includes a 125 litre paint tank, mounting brackets and fasteners. It can be mounted onto the RoadPak frame or the accessory frame kit.

239934                      PAINT TRANSFER KIT  
Kit used to transfer paint from one location to another. Air-driven, double-diaphragm Husky™ pump powered by the RoadPak. Includes all hoses, fittings, 208 litre drum and siphon kit.



# RoadPak™ Accessories

PART NUMBER	DESCRIPTION
<b>CHOOSE YOUR ROADPAK MODULE ACCESSORIES (continued)</b>	
239935	<b>PAINT DRUM AGITATOR KIT</b> Kit used to mix paint in a 208 litre drum. All SST construction air-driven Twistork™ motor powered by the RoadPak air system.
24J149	<b>BOTTOM FEED FITTINGS KIT (FOR PAINT TANK)</b> Kit allows user to drill a hole in the bottom of the 125 litre paint tank and connect fittings so the material can flow out the bottom of the tank rather than being sucked out the top.
24G774	<b>ROADPAK Y-STRAINER KIT</b> Kit is a Y-strainer that connects inline between the paint drum and the pump inlet.
24G765	<b>ROADPAK 205 KG BEAD TANK KIT</b> Kit has a bead tank with regulator, mounting brackets and fasteners. It can be mounted onto the RoadPak frame or the accessory frame kit
25D608	<b>ROADPAK 615 KG BEAD TANK KIT WITH FRAME</b> Kit has a 615 kg bead tank installed in an accessory frame
25D641	<b>ROADPAK 615 KG BEAD TANK</b> Kit has a 615 kg bead tank with regulator, mounting brackets and fasteners
24G772	<b>ROADPAK 3<sup>RD</sup> GUN KIT (ROADPAK BEFORE 2018)</b> Kit comes with a dual acting paint gun, dual acting bead gun, the hardware and hoses to connect the guns to the system
24G775	<b>ROADPAK DOUBLE DROP KIT</b> Kit is for element double drop application. It comes with one bead gun, one bead hose and fittings to connect the parts
24G776	<b>WATERBORNE SIPHON KIT (ROADPAK ONLY)</b> Suction hose for waterborne materials
24G777	<b>SOLVENT SIPHON KIT (ROADPAK ONLY)</b> Suction hose for oil-based materials
24G979	<b>BEAD GUN KIT</b> Kit for a single bead gun
24G980	<b>PAINT GUN KIT</b> Kit for a single paint gun
24G778	<b>ROADPAK STENCIL GUN KIT</b>
238957	<b>HAND BEAD GUN KIT</b>
24H585	<b>ROADPAK ACCESSORY FRAME KIT</b> Accessory frame that includes the hardware to connect it to the RoadPak frame







# ► THERMOPLASTIC APPLICATIONS







# ThermoLazer™

## FEATURES

### UNITS

ThermoLazer 200tc  
ThermoLazer 300tc  
ThermoLazer ProMelt

## SPECIFICATIONS

## ACCESSORIES



# ThermoLazer™ Kettle Systems

A kettle system for your needs. That's what we strive for. High volume ThermoLazers with external refills or built-in heaters or a medium volume ThermoLazer with easy kettle exchange for colour changes, Graco offers it all.



## ▶ ThermoLazer 200rc Exchangeable Kettle System

Easy exchange of the kettle system allows fast colour changes. Use multiple colours on the same machine by exchanging kettles on the jobsite. No more hassle with multiple dedicated units.



## ▶ ThermoLazer 300rc Dual PaddleMax™ System

Reduce the need to constantly refill with a 135kg single chamber hopper. The single chamber design allows easy refills from an external kettle system and the Dual Paddles make mixing materials easy.



## ▶ ThermoLazer ProMelt QuadMelt™ System

Stepping up to the ProMelt QuadMelt system offers you four on-board chambers that can melt 135 kg of material in less than 1 hour, significantly increasing your daily productivity. The four chamber design offers more surface area to quickly melt thermoplastic and is supported by 100,000 BTU burners which increases melt time and productivity.

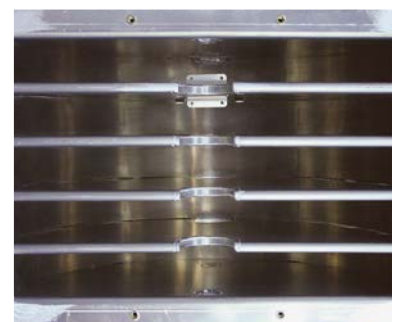

# ThermoLazer™ Die Systems

From narrow over wide to double lines, choose the Die-System for your ThermoLazer: SmartDie II for ThermoLazer 300Tc and ProMelt or FlexDie for ThermoLazer 200Tc. These hardened steel dies come with an innovative, built-in line thickness adjustment system that allow you to easily dial down to the desired depth. Our Die Systems come in a variety of sizes allowing you to do narrow or wide lines or win time and money with our Double Line Systems.



## ► Line Types

### Narrow Lines



### Wide Lines



### Double Lines



## ► Features



Line Thickness Adjustment

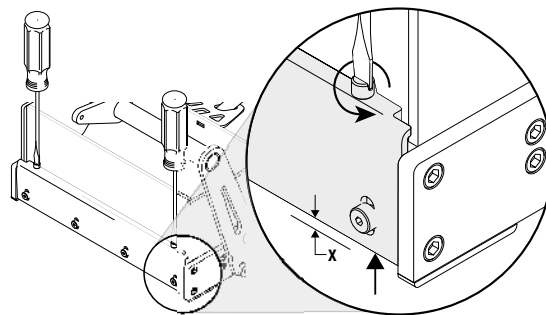

X ↑	↻ #Turns
30	0.6
60	1.2
90	1.8
120	2.4
150	3.0
mm	#Turns
0.5	0.4
1.0	0.8
1.5	1.2
2.0	1.6

BlackDie™ surface for maximum heat retention



Handle bar for easy die replacement and disassembly without tools



# ThermoLazer™ Units





# ThermoLazer™ 200Tc



ThermoLazer 200Tc



## ► Applications & Materials

The ThermoLazer System, brought to you by Graco is one of the most productive and easy to use thermoplastic handliners in the industry. The ThermoLazer 200Tc is an ideal unit to expand your thermo fleet with a small push-behind unit for those small jobs.

## ► Features & Benefits

### FlexDie™ System

- Delivers excellent line quality with exclusive deep-die, all steel construction and a no-tools change-out design

### 90 kg Material Kettle

- Easy-to-fill cylindrical kettle allows precise melting of thermoplastic material, and its no-tool change-out design lets you switch colours fast

### 18 kg Bead Hopper

- Perfectly matched to the material kettle with a superior flow design

### Direct Heat System

- Direct flames and an on-board hand torch deliver maximum heat, resulting in maximum material flow

### Tri-Wheel System

- Dual solid front and single solid rear wheels provide smooth, quiet operation

### Adjustable Handle

- Handle easily adjusts to multiple heights

### Adjustable Front Pointer

- Easily adjusts for all size dies for following all marks and creating straight lines

### Bead Dispenser

- 30 cm dispenser with 2.5 cm increments allows you to "dial-in" the drop rate

# ThermoLazer™ 300Tc



ThermoLazer 300Tc



## ► Applications & Materials

The ThermoLazer 300Tc with its 135 kg material kettle allows more striping and less time spent refilling with material, while its' EasyGlide™ Wheel Mount System makes this unit as easy to maneuver as a LineLazer.

## ► Features & Benefits

### SmartDie II System

- Delivers excellent line quality with exclusive deep-die, all steel construction and a no-tools change out design

### 135 kg Material Kettle

- Easy-to-fill kettle with PaddleMax Dual mixer for improved mixing

### 40 kg Bead Hopper

- Perfectly matched to the material kettle with a superior flow design

### Direct Heat System

- Direct flames and an on-board hand torch deliver maximum heat, resulting in maximum material flow

### Adjustable Handle

- Handle easily adjusts to multiple heights

### Adjustable Front Pointer

- Easily adjusts for all size dies for following all marks and creating straight lines

### Bead Dispenser

- 30 cm dispenser with 2,5 cm increments allows you to "dial-in" the drop rate

# ThermoLazer™ ProMelt

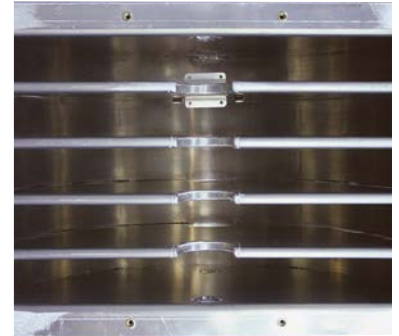

ThermoLazer ProMelt

## ► Applications & Materials

Only Graco's breakthrough technology allows you to melt 135 kg of thermoplastic on-board in less than an hour. It's like having a premelter on wheels without the cost. Finally a solution for melting and applying thermoplastic without the hassle and cost of premelters.

## ► Features & Benefits

### ProMelt Technology

- 4 Chamber Melting System—More surface area to melt thermoplastic fast
- 100,000 BTUs—Faster melt time means more jobs get done everyday

### SmartDie II System

- Delivers excellent line quality with exclusive deep-die, all steel construction and a no-tools change-out design

### 135 kg Material Kettle

- Easy-to-fill four chamber Quadmelt kettle system for improved heat transfer and mixing

### 40 kg Bead Hopper

- Perfectly matched to the material kettle with a superior flow design

### Adjustable Handle

- Handle easily adjusts to multiple heights

### Adjustable Front Pointer

- Easily adjusts for all size dies for following all marks and creating straight lines

### Bead Dispenser

- 30 cm dispenser with 2,5 cm increments allows you to "dial-in" the drop rate



# Specifications

## UNITS

ThermoLazer 200rc



ThermoLazer 300rc



ThermoLazer ProMelt



SPECIFICATIONS			
Part Number - unit only	24U281	24H622	24H624
Fuel	LP gas (LP tank not included)	LP gas (LP tank not included)	LP gas (LP tank not included)
Die Heater system	-	Tri-Flame	Tri-Flame
Main Burners	30.000 BTU	30.000 BTU	100.000 BTU
Material Capacity – kg (lb)	90 (200)	135 (300)	135 (300)
Melt Time for full capacity Thermoplastic	-	4-4,5 hours without premelt system	Less than 1 hour
Melt chamber	Single	Single	QuadMelt
Bead Hopper Capacity – kg (lbs)	18 (40)	40 (90)	40 (90)
Weight – kg (lbs)	118 (260)	133 (295)	157 (345)
FEATURES			
Dies available	FlexDie	SmartDie II	SmartDie II
Temperature Limit Control	N/A	N/A	475° F Switch
Electronic Ignition	No	✓	✓
Torch	✓	✓	✓
LineDriver*	No	Optional	Optional
External 4-torch die heat system	Burners on FlexDie	Optional	Standard
Internal Mixing Paddles	Single mixing paddle	Dual PaddleMax System	QuadMix System
Hopper Lid System	Flat, Single Lid	Flat, Dual Lid	Raised, Single Lid
Bead Dispense System	30 cm with 2.5 cm doors	30 cm with 2.5 cm doors	30 cm with 2.5 cm doors

\* SEE PAGE 22-23 AND 51 FOR MORE INFORMATION ON LINEDRIVER.



# THERMOLAZER™ ACCESSORIES

PART NUMBER	DESCRIPTION
24R144	BEAD DISPENSER KIT (30 CM WITH 2.5 CM SLOTS)
257368	SCREEN, FILTER
24C528	KIT, DOUBLE DROP DISPENSER (THERMOLAZER 300TC/PROMELT)
24J179	SCRAPER KIT, LONG HANDLE (FOR CLEANING PROMELT KETTLE)
24J356	SCRAPER BLADES (5-PACK)
24H619	REAR BURNER KIT 4-TORCH (THERMOLAZER 300TC/PROMELT)
25R505	LINEDRIVER HITCH KIT (THERMOLAZER 300TC/PROMELT)
17B190	40 CM BEAD DISPENSER (FOR DIES LARGER THAN 30 CM)
16Y835	EXTRA KETTLE FOR THERMOLAZER 200tc (ADDING EXTRA COLOUR)



PART NUMBER	SIZE CM (IN)
THERMOLAZER 300tc + THERMOLAZER PROMELT	

## SMARTDIE

SINGLE LINE SMARTDIE	PART NUMBER	SIZE CM (IN)
	17A173	5 (2)
	24H431	8 (3)
	24H426	10 (4)
	17J250	12 (4.75)
	24H432	13 (5)
	24H427	15 (6)
	24H433	18 (7)
	24H428	20 (8)
	24H434	22.5 (9)
	24H429	25 (10)
	24H430	30 (12)
	17A174	40 (16)



DOUBLE LINE SMARTDIE	PART NUMBER	SIZE CM (IN)
	24H437	8-8-8 (3-3-3)
	24H435	10-8-10 (4-3-4)
	24H436	10-10-10 (4-4-4)
	24J785	10-15-10 (4-6-4)

PART NUMBER	SIZE CM (IN)
THERMOLAZER 200tc	

## FLEXDIE

SINGLE LINE FLEXDIE	PART NUMBER	SIZE CM (IN)
	16Y661	5 (2)
	16Y662	8 (3)
	16Y320	10 (4)
	16Y663	12 (5)
	16Y190	15 (6)
	16Y664	18 (7)
	16Y326	20 (8)
	16Y665	22.5 (9)
	16Y332	25 (10)
	16Y207	30 (12)

DOUBLE LINE FLEXDIE	PART NUMBER	SIZE CM (IN)
	16Y338	8-8-8 (3-3-3)
	16Y352	10-8-10 (4-3-4)
	16Y363	10-10-10 (4-4-4)

# ▶ PARTS







**OEM PARTS**

**TIPS & NOZZLES**

**HOSES**

**SWIVELS, ADAPTERS & NIPPLES**

**REPAIR PARTS**

# OEM Pumps and Guns



# OEM Pumps and Guns

## PUMPS



PART NUMBER	DESCRIPTION	BEAD TANK (KG)	FLOW (LPM)	MAX. PRESSURE (BAR)
25M701	ROADPAK 1-PUMP MODULE	204	18.9	200
25M702	ROADPAK 1-PUMP MODULE, OEM	NO BEAD TANK	18.9	200
25M703	ROADPAK 2-PUMP MODULE	204	18.9	200
25M704	ROADPAK 2-PUMP MODULE	612	18.9	200
25M705	ROADPAK 2-PUMP MODULE, OEM	NO BEAD TANK	18.9	200
25M706	ROADPAK HD 2-PUMP MODULE	612	37.8	200
25M707	ROADPAK HD 2-PUMP MODULE, OEM	NO BEAD TANK	37.8	200
24G767	RPS 2900 OEM KIT		18.9	275
24U325	GH2570 OEM KIT		26.5	172
24J345	LL 130hs PUMP KIT		4.9	227
24B932	LL 200hs PUMP KIT		8.14	250
16T532	LL 250 PUMP KIT		9.5	227
24W299	GH 300 PUMP KIT		11.3	227
24W298	GH 200 PUMP KIT		8.1	227
238349	VISCOUNT PUMP, ROADLAZER		9.5	138



## GUNS



238377	AUTOMATIC PAINT GUN			
24G980	AUTOMATIC PAINT GUN DOUBLE ACTING			
238338	AUTOMATIC BEAD GUN			
24G979	AUTOMATIC BEAD GUN DOUBLE ACTING			
248157	FLEXPLUS STRIPING GUN, RAC V GUARD, LL5319 TIP			
235460	SILVER GUN, 2-FINGER, FLAT TIP GUARD, NO TIP			



# LL5 Spray Tips: Creating Laser-Sharp Lines

## ► Graco's LineLazer RAC V SwitchTips

Specially designed for Line Striping Equipment, Graco's LL5 spray tips create clean and laser-sharp lines with no fuzzy edges. LL5 tips spray heavy waterbase to thin alkyd traffic paint and ensures consistent paint thickness, from edge to edge, less overspray and long-lasting lines.

### Understanding Tips

The pump delivers:

- Paint flow
- Paint pressure

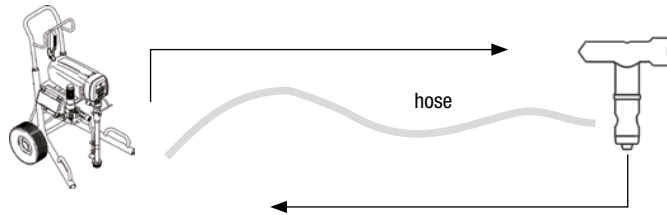

The tip defines:

- Spray angle
- Spray volume

The tip size tells the pump how hard it must work.

### The Secret behind the Numbers

(All tip specifications are measured 30 cm away from the surface)



The first digit describes the angle, i.e. 6 = 60°.

Multiply first digit by 5 to get the actual fan width when spraying 30 cm away from the wall, i.e.  $6 \times 5 = 30$  cm.

The 2<sup>nd</sup> and 3<sup>rd</sup> digits describe the orifice size, i.e. 21 = 0.021".

### Adjusting to the Right Tip

Basic rule: when switching tips, adjust to the new fan width and new orifice size. Together. e.g.: 517 -> 619

PROBLEM	SOLUTIONS
<p><b>Too much paint?</b></p> <p>0.017" = 1.17 lpm</p>	<p>1. Reduce orifice size</p> <p><b>513</b></p> <p>0.013" = 0.7 lpm</p> <p>2. Increase fan angle</p> <p><b>717</b></p>
<p><b>Not enough paint?</b></p> <p>0.017" = 1.17 lpm</p>	<p>1. Increase orifice size</p> <p><b>521</b></p> <p>0.021" = 1.8 lpm</p> <p>2. Decrease fan angle</p> <p><b>317</b></p>

# LL5 Spray Tips

## When to replace a Tip?

A spray tip controls the amount of fluid sprayed by using different orifice sizes. The shape of the orifice on the other hand, determines the spray pattern. The chart below explains the impact of tip wear on the quality of your job.

### WHAT IS TIP WEAR?

- 1) **FAN WIDTH DECREASES** = MORE PASSES NECESSARY = MORE LABOUR  
 +  
 2) **ORIFICE SIZE INCREASES** = MORE PAINT COMES OUT = MORE MATERIAL COST  
 ———  
**TOTAL: TWICE THE LABOUR!** + 30% MORE PAINT FOR THE SAME SURFACE!

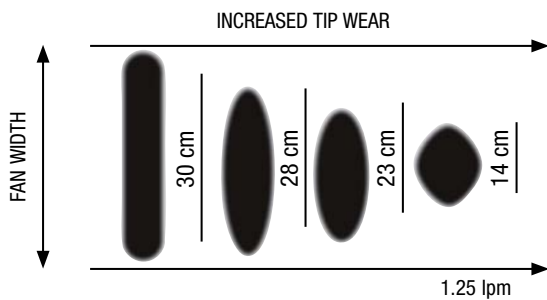

### TIP WEAR CHART:

FAN WIDTH - NEW TIP	FAN WIDTH - WHEN WORN
5 cm	4 cm
10 cm	8 cm
15 cm	12 cm
20 cm	15 cm
25 cm	20 cm
30 cm	25 cm
35 cm	30 cm
40 cm	35 cm
45 cm	40 cm

\* These are recommendations only.

\* Paint abrasion and pressure are the two variables increasing wear speed.

# Spray Tips

## LL5XXX



ORIFICE	FLOW LPM	FAN WIDTH			
		5 cm	10 cm	15 cm	30 cm
.013	.69	213	-	-	-
.015	.91	215	315	-	-
.017	1.17	217	317	417	-
.019	1.47	219	319	419	-
.021	1.79	-	321	421	621
.023	2.15	-	323	423	623
.025	2.54	-	325	425	625
.027	2.96	-	327	427	627
.029	3.42	-	329	429	629
.031	3.90	-	331	431	631
.033	4.42	-	333	-	-
.035	4.98	-	335	435	635
.039	6.18	-	339	439	639
.043	7.51	-	343	443	643
.055	12.29	-	355	-	-

**PART  
NUMBER**      **DESCRIPTION**

## GUARDS



243161      RAC V GUARD



# Spray Tips

262XXX



		FAN WIDTH								
ORIFICE	FLOW LPM	5 cm	10 cm	15 cm	20 cm	25 cm	30 cm	35 cm	40 cm	50 cm
.007	.2	-	207	307	-	-	-	-	-	-
.009	.3	109	209	309	409	509	609	-	-	-
.011	.5	111	211	311	411	511	611	-	-	-
.013	.69	113	213	313	413	513	613	-	-	-
.015	.91	115	215	315	415	515	615	-	815	-
.017	1.17	-	217	317	417	517	617	-	817	917
.019	1.47	119	219	319	419	519	619	-	819	-
.021	1.79	121	221	321	421	521	621	721	821	-
.023	2.15	-	223	323	423	523	623	723	-	-
.025	2.54	-	225	325	425	525	625	725	-	-
.027	2.96	-	-	327	427	527	627	-	827	-
.029	3.42	-	-	-	429	529	629	729	-	-
.031	3.90	-	-	331	431	531	631	-	831	-
.033	4.42	-	-	-	433	533	633	-	833	-
.035	4.98	-	235	-	435	535	635	735	835	935
.039	5.86	-	-	-	439	-	-	-	-	-
.043	6.45	-	-	-	443	543	-	-	-	-
.045	7.5	-	-	-	-	-	645	-	-	-
.051	10.5	-	-	-	451	551	-	-	-	-
.055	12.3	-	-	-	455	555	655	-	-	-
.063	16.3	-	-	-	-	563	-	-	-	-

# Spray Tips

163XXX



ORIFICE	FLOW LPM	FAN WIDTH								
		5 cm	10 cm	15 cm	20 cm	25 cm	30 cm	35 cm	40 cm	45 cm
.07	.20	107	207	307	-	-	-	-	-	-
.09	.33	109	209	309	409	509	609	-	-	-
.111	.49	111	211	311	411	511	611	711	-	-
.13	.69	113	213	313	413	513	613	713	813	-
.15	.91	115	215	315	415	515	615	715	815	915
.17	1.17	117	217	317	417	517	617	717	817	917
.19	1.47	119	219	319	419	519	619	719	819	919
.21	1.79	121	221	321	421	521	621	721	821	921
.23	2.15	-	223	323	423	523	623	723	823	923
.25	2.54	-	225	325	425	525	625	725	825	925
.27	2.96	-	227	327	427	527	627	727	827	927
.29	3.42	-	-	329	429	529	629	729	829	929
.31	3.90	-	231	331	431	531	631	731	831	931
.33	4.42	-	-	-	433	-	633	733	833	933
.35	4.98	-	235	335	435	535	635	735	835	935
.37	5.56	-	-	-	-	-	637	737	-	-
.39	6.18	-	239	339	439	539	639	-	839	939
.41	6.83	-	-	341	441	541	641	-	841	-
.43	7.51	-	-	-	443	543	643	-	-	943
.45	8.23	-	-	-	445	545	645	-	845	-
.47	8.98	-	-	-	-	547	647	-	847	-
.49	9.76	-	-	-	449	-	-	749	849	-
.51	10.67	-	-	351	451	551	651	-	-	-
.55	12.29	-	-	-	455	555	655	-	-	-
.57	13.20	-	-	357	457	557	657	757	-	-
.59	14.14	-	-	-	459	-	-	-	-	-
.61	15.12	-	-	-	461	561	661	-	861	-
.63	16.13	-	-	-	463	563	663	-	-	-
.65	17.17	-	-	-	465	565	665	-	865	-
.67	18.24	-	-	-	-	-	667	-	-	-
.71	20.48	-	-	-	471	-	671	-	871	-
.77	24.00	-	-	-	477	-	-	-	-	-

**PART  
NUMBER**

**DESCRIPTION**

## GUARDS



220251

FLAT TIP GUARD

# Hoses

PART NUMBER	DESCRIPTION	FITTINGS
<b>BLUEMAX™ II</b>		
227 bar (3300 psi)		
82°C Temperature Rating		
238358	3/16 in x 0.9 m	1/4" NPS(f) – 1/4" NPT(m)
238959	3/16 in x 1.4 m	1/4" NPS(f) – 1/4" NPT(m)
238359	3/16 in x 1.8 m	1/4" NPS(f) – 1/4" NPT(m)
214981	3/16 in x 4.6 m	1/4" NPS(f)
214698	3/16 in x 7.5 m	1/4" NPS(f)
214697	3/16 in x 15 m	1/4" NPS(f)
223756	1/4 in x 4.6 m	1/4" NPS(f)
240793	1/4 in x 7.5 m	1/4" NPS(f)
240794	1/4 in x 15 m	1/4" NPS(f)
223771	1/4 in x 30 m	1/4" NPS(f)
240796	3/8 in x 7.5 m	3/8" NPS(f)
240797	3/8 in x 15 m	3/8" NPS(f)
241275	3/8 in x 30 m	3/8" NPS(f)
<b>BLUEMAX II HP</b>		
276 bar (4000 psi)		
82°C Temperature Rating		
277249	1/4 in x 0.9 m	1/4" NPS(f) – 3/8" NPT(m)
277250	1/4 in x 15 m	1/4" NPS(f)
277351	3/8 in x 0.9 m	3/8" NPS(f) – 1/2" NPT(m)
277251	3/8 in x 15 m	3/8" NPS(f)
277253	1/2 in x 15 m	1/2" NPT(f)
<b>XTREME DUTY HIGH PRESSURE AIRLESS HOSE</b>		
310 bar (4500 psi)		
H42503	1/4 in x 0.9 m	1/4" NPS(f)
H42506	1/4 in x 1.8 m	1/4" NPS(f)
H42510	1/4 in x 3 m	1/4" NPS(f)
H42525	1/4 in x 7.5 m	1/4" NPS(f)
H42550	1/4 in x 15 m	1/4" NPS(f)
H4251X	1/4 in x 30 m	1/4" NPS(f)
H43803	3/8 in x 0.9 m	3/8" NPS(f)
H43806	3/8 in x 1.8 m	3/8" NPS(f)
H43810	3/8 in x 3 m	3/8" NPS(f)



# Swivels, Adapters & Nipples

PART NUMBER	DESCRIPTION	MAX. WORKING PRESSURE – BAR	SEAL MATERIAL	SWIVEL MATERIAL

## GUN SWIVELS

### M X F STRAIGHT SWIVEL UNION

244515	1/4" NPT(M) x 1/4" NPSM(F)	210	LEATHER	CS
223341	1/4" NPT(M) x 1/4" NPSM(F)	250	PTFE	CS
239663	1/4" NPT(M) x 1/4" NPSM(F)	250	LEATHER	CS
207947	1/2" NPT(M) x 1/2" NPT(F)	410		CS ZINK PLATED

## SWIVEL UNIONS

### M X F STRAIGHT SWIVEL UNION

156823	1/4" NPT(M) x 1/4" NPT(F)	690		CS
157705	1/4" NPT(M) x 3/8" NPSM(F)	515		CS
190451	1/2" NPT(M) x 1/2" NPSM(F)	206		CS

### F X F STRAIGHT SWIVEL UNION

159153	1/4" NPT(F) x 3/8" NPT(F)	515		CS
156173	3/8" NPSM(F) x 1/4" NPT(F)	510		CS
161077	1/2" NPT(F) x 3/8" NPSM(F)	240		CS
155865	1/2" NPSM(F) x 1/2" NPT(F)	500		CS

## HEX NIPPLE

### M X M STRAIGHT NIPPLE

162453	1/4" NPSM(F) x 1/4" NPT NPSM	515		CS
156971	1/4" NPT x 1/4" NPT	515		CS
156849	3/8" NPT x 3/8" NPT	500		CS
196178	3/8" NPSM x 3/8" NPT	350		CS WITH E-NICKEL
157350	3/8" NPT x 1/4" NPT	413		CS
158491	1/2" NPT x 1/2" NPT	510		CS

# Swivels, Adapters & Nipples

PART NUMBER	DESCRIPTION	MAX. WORKING PRESSURE – BAR	SEAL MATERIAL	SWIVEL MATERIAL

## REDUCING NIPPLES

### M X M

191872	1/8" NPT x 1/4" NPSM	345		CS
165274	1/4" NPT x 11/16" - 27 UNS	345		CS
164856	3/8" NPT x 1/4" NPT	550		SS
164672	3/8" NPT x 1/4" NPSM	413		CS
196177	3/8" NPT x 1/4" NPSM	415		CS WITH E-NICKEL
161800	3/4" NPT x 3/8" NPSM	275		CS
196142	3/4" NPT x 1/2" NPT	345		CS
158979	1/2" NPT x 3/8" NPT	375		CS WITH E-NICKEL
159239	1/2" NPT x 3/8" NPT	510		CS

## ADAPTERS

### M X F

244825	1/4" NPT, 7/8" - 14 UNP	230		CS
104969	1/2" NPT x 3/4" NPT	275		CS
181085	7/8" NPT - 14 UNF, 11/16" NPT - 16 UNEF metric gun to Graco guard	345		CS
181084	7/8" - 14 UNF, 3/4" NPT	345		CS
164120	11/16" - 16 UNEF, 3/4" NPT 7/8" - 14 UNF-2B Graco gun to metric guard	345		CS
159841	1/4" NPT(F) x 3/8" NPT(M)	345		CS

## PIPE TEES

### F X F X M

106228	2 X 1/4" NPT(F) x 1/4" NPT(M)	210		BRASS
108673	2 X 3/8" NPT(F) x 3/8" NPT(M)	275		SS
111337	2 X 3/4" NPT(F) x 3/4" NPT(M)	275		CS

## BALL VALVES

239280	1/4" NPT(MBE)	350		FLUOELASTOMER
238694	3/8" NPT(MBE)	350		PTFE / SS
223522	1/4" NPT(M) x DRILLED PLUG	350		FLUOELASTOMER
224441	3/8" NPT(M) x DRILLED PLUG	350		FLUOELASTOMER
238967	3/8" NPT(M) (MBE)	350		PTFE WITH PEEK SEAT

# Repair Parts

LINELAZER - ROADPAK	QUICK REFERENCE							
	LINELAZER ES 1000	LINELAZER V ES 2000	LINELAZER 3400	LINELAZER V 3900	LINELAZER V 5900	LINELAZER 130HS	LINELAZER V 200HS/DC	
LOWER PUMP KIT	242731	277069	246428	277069	277070	248748	277068	
PACKING REPAIR KIT	244194	248212	244194	248212	248213	288471	246341	
CARBIDE SEAT KIT	246429	239922	246429	239922	244199	244199	240918	
PUMP ROD	24W617	248206	249125	248206	248207	288479	249000	
PUMP SLEEVE	24W619	248209	243176	248209	248210	248210	240921	
FILTER REPAIR KIT	-	-	287685	288100	288100	248749	288100	
CLUTCH REPAIR KIT	-	-	241109	241109	241113	-	-	
PINION HOUSING KIT	-	-	287376	287463	287465	-	-	
DRIVE HOUSING KIT	24W817	287284	-	287467	287469	-	-	
DISTANCE SENSOR KIT	-	15K357	-	15K357	15K357	-	15K357	
HYDRAULIC TRIP ROD/PISTON/CAP REPAIR KIT	-	-	-	-	-	288735	288754	
HYDRAULIC MOTOR REPAIR KIT	-	-	-	-	-	288758	248021	
HYDRAULIC MOTOR SEAL REPAIR KIT	-	-	-	-	-	246174	246174	
HYDRAULIC PUMP KIT (HD)	-	-	-	-	-	288733	287179	
HYDRAULIC 1:1 PROPORTIONER KIT	-	-	-	-	-	-	-	
MIX MANIFOLD COMPLETE	-	-	-	-	-	-	-	
BPO SLAVE PUMP COMPLETE	-	-	-	-	-	-	-	
BPO SLAVE PUMP BEARING & WIPER KIT	-	-	-	-	-	-	-	
BPO SLAVE PUMP FOOT VALVE REPAIR KIT	-	-	-	-	-	-	-	
BPO SLAVE PUMP THROAT SEAL REPAIR KIT	-	-	-	-	-	-	-	
BPO SLAVE PUMP PISTON REPAIR KIT	-	-	-	-	-	-	-	
BAFFLE KETTLE REPAIR KIT	-	-	-	-	-	-	-	
TEMPERATURE CONTROL KIT	-	-	-	-	-	-	-	
PILOT REPAIR KIT	-	-	-	-	-	-	-	
THERMOPILE REPAIR KIT	-	-	-	-	-	-	-	
GAS VALVE REPAIR KIT	-	-	-	-	-	-	-	
IGNITER REPAIR KIT	-	-	-	-	-	-	-	
COMPLETE PILOT/THERMOPILE REPAIR KIT	-	-	-	-	-	-	-	

# Repair Parts

	LINELAZER V 250SPS/DC	LINELAZER V 200mma 1:1	LINELAZER V 250mma 98:2	LINEDRIVER 160	LINEDRIVER HD 200	LINEDRIVER ES	ROADPAK	THERMOLAZER 200tc	THERMOLAZER 300tc	THERMOLAZER ProMelt
	277068	277068	277068	-	-	-	287834	-	-	-
	246341	246341	246341	-	-	-	287835	-	-	-
	240918	240918	240918	-	-	-	287838	-	-	-
	249000	249000	249000	-	-	-	287832	-	-	-
	240921	240921	240921	-	-	-	287833	-	-	-
	24N517	288100	24N517	-	-	-	-	-	-	-
	-	-	-	116875	247631	-	-	-	-	-
	-	-	-	-	-	-	-	-	-	-
	-	-	-	-	-	-	-	-	-	-
	15K357	15K357	15K357	-	-	-	-	-	-	-
	288754	288754	288754	-	-	-	-	-	-	-
	248021	248021	248021	-	-	-	-	-	-	-
	246174	246174	246174	-	-	-	287870	-	-	-
	16X083	287179	16X083	247930	247930	-	24J517 (17V283)	-	-	-
	-	131818	-	-	-	-	-	-	-	-
	-	-	17H095	-	-	-	-	-	-	-
	-	-	17H093	-	-	-	-	-	-	-
	-	-	16P185	-	-	-	-	-	-	-
	-	-	16N961	-	-	-	-	-	-	-
	-	-	16N963	-	-	-	-	-	-	-
	-	-	16N964	-	-	-	-	-	-	-
	-	-	-	-	-	-	-	-	-	24J571
	-	-	-	-	-	-	-	17B232	24C397	24J569
	-	-	-	-	-	-	-	24J574	24J575	24J574
	-	-	-	-	-	-	-	122944	122944	122944
	-	-	-	-	-	-	-	17B233	16F638	16F638
	-	-	-	-	-	-	-	-	123085	123085
	-	-	-	-	-	-	-	24U190	24U190	24T749



# ▶ WARRANTY

---





► **Warranty**

	5 YEARS	2 YEARS	1 YEAR
<b>UNITS</b>			
CART		CONTROL BOX & COMPONENTS	FLUID SECTION
DRIVE SYSTEM		ELECTRIC COMPONENTS	HYDRAULIC GROUP
HYDRAULIC MOTOR HARD PARTS		CLUTCH	GAS GROUP
		PUMP LOWER HARD PARTS	

**ACCESSORIES**

			GUN BODIES & ATTACHMENTS
--	--	--	--------------------------

**WEAR ITEMS**

			Graco does not cover wear items: tips, filters, sleeves, rods, packings, repair kits, seats, balls, brushes, dies, ...
--	--	--	--

**OTHER WARRANTIES**

			Components not manufactured by Graco are covered by their own warranties: gasoline engines, hoses and batteries. All Graco products are covered by a one year warranty period against manufacturing defects. Consult our "Blue Book" (Form No. B0170) for complete detailed information on Graco's policies (warranty, freight, returns, etc.).
--	--	--	---









## ABOUT GRACO

Founded in 1926, Graco is a world leader in fluid handling systems and components. Graco products move, measure, control, dispense and apply a wide range of fluids and viscous materials used in vehicle lubrication, commercial and industrial settings.

The company's success is based on its unwavering commitment to technical excellence, world-class manufacturing and unparalleled customer service. Working closely with qualified distributors, Graco offers systems, products and technology that set the quality standard in a wide range of fluid handling solutions. Graco provides equipment for spray finishing, protective coating, paint circulation, lubrication, and dispensing sealants and adhesives, along with power application equipment for the contractor industry. Graco's ongoing investment in fluid management and control will continue to provide innovative solutions to a diverse global market.

## GRACO LOCATIONS

### MAILING ADDRESS

P.O. Box 1441  
Minneapolis, MN 55440-1441  
Tel: 612-623-6000  
Fax: 612-623-6777

### AMERICAS

#### MINNESOTA

Worldwide Headquarters  
Graco Inc.  
88-11th Avenue N.E.  
Minneapolis, MN 55413

### EUROPE

#### BELGIUM

European Headquarters  
Graco Distribution BV  
Industrieterrein-Oude Bunders  
Slakweidestraat 31  
3630 Maasmechelen  
Belgium  
Tel: 32 89 770 700  
Fax: 32 89 770 777

### ASIA PACIFIC

#### AUSTRALIA

Graco Australia Pty Ltd.  
Suite 17, 2 Enterprise Drive  
Bundoora, Victoria 3083  
Australia  
Tel: 61 3 9468 8500  
Fax: 61 3 9468 8599

#### CHINA

Graco Hong Kong Ltd.  
Shanghai Representative Office  
Building 7  
1029 Zhongshan Road South  
Huangpu District  
Shanghai 200011  
The People's Republic of China  
Tel: 86 21 649 50088  
Fax: 86 21 649 50077

#### INDIA

Graco Hong Kong Ltd.  
India Liaison Office  
Room 432, Augusta Point  
Regus Business Centre 53  
Golf Course Road  
Gurgaon, Haryana  
India 122001  
Tel: 91 124 435 4208  
Fax: 91 124 435 4001

#### JAPAN

Graco K.K.  
1-27-12 Hayabuchi  
Tsuzuki-ku  
Yokohama City, Japan 2240025  
Tel: 81 45 593 7300  
Fax: 81 45 593 7301

#### KOREA

Graco Korea Inc.  
38, Samsung 1-ro 1-gil  
Hwaseong-si, Gyeonggi-do,  
18449  
Republic of Korea  
Tel: 82 31 8015 0961  
Fax: 82 31 613 9801

All written and visual data contained in this document are based on the latest product information available at the time of publication. Graco reserves the right to make changes at any time without notice.

Graco is certified ISO 9001.



**Europe**  
+32 89 770 700  
FAX +32 89 770 777  
WWW.GRACO.COM