

March[®] Rifle Scope

First Focal Plane Reticle Scope

Owner's Manual
(English Language Edition)



*Thank you for purchasing your March Rifle Scope.
Please read this owner's manual thoroughly before
using your scope.*

WARNING:

Never use a telescope to look at the Sun.

Using a rifle scope to look at the Sun will cause permanent and irreversible eye damage.

Make sure that you set enough eye relief position of your scope to prevent injury from recoil. Setting your new scope with incorrect eye relief and improper mounting can cause physical damage to the shooter.

Before you mount your new March Scope

Your new March scope has come out of the factory but will need to be set up for your eyes. Before you begin using your March scope, you will need to take a moment to level the scope's reticle, focus the reticle for your eyes and bore sight your rifle.

Leveling the reticle for your new March scope is covered on Page 4. Taking the time to do this as you set up your new scope is important to avoid canting and long range shooting errors.

The best way to focus your March scope's reticle is covered on Page 4. This can either be done before or after the scope is mounted on your rifle.

Bore sighting your March scope is covered in more detail on Page 5. Making sure the rings and bases are perfectly aligned before setting up your new scope will help to remove possible sighting errors by eliminating structural pressure on your new scope. It will also keep your March scope as close to its optical center as possible.

Adjusting your new March scope to the extremes of the elevation or windage dials prevents you from sighting through the central axis of the scope. This means you will see the target through the outer edges of the optics, and this will degrade the image resolution.

We hope the following advice is helpful to you in setting up your new March scope.



Mounting your new March Scope

Preferred Rings and Bases

March recommends a one piece base such as a picatinny mount or a Stolle type benchrest rail. A one piece mount removes many of the alignment problems commonly seen in two piece mounting systems.

If a one piece base is not an option with your rifle, then that should not be a serious problem. We recommend that whenever scope rings are installed on a rifle, their alignment needs to be checked before a scope is mounted.

The best way to do this is to use a precision 30mm ring (or 34mm for the March-X and March-FX models) alignment tool. Some lapping of the scope rings may be required to bring the scope rings into alignment. However, if a scope is mounted in rings that are out of alignment then damage to your new March scope could occur or potentially unreliable performance. Your March Scope dealer can advise on some proper tools to assist you mount your scope in the rings.

Position the scope rings so they do not sit too near the extreme ends of the scope or even too close together and use a torque wrench to tighten the scope ring screws. Positioning the rings at the extreme end of the scope body could also cause damage to your new March. Check manufacturers specifications for torque value. Usually 1.7-2.2 Nm but will vary depending on Alloy or Steel.

Setting the Eye Relief

With the bolt removed from the unloaded rifle, aim the rifle in your usual shooting position. Very slowly move your March scope until you can see the full field of view. No dark circles at the edges should be present at this stage, and there will be a comfortable eye relief.

Make sure that you set enough eye relief position of your scope to prevent injury from recoil. Setting your new scope with incorrect eye relief and improper mounting can cause physical damage to the shooter.

Leveling the Reticle

It is very important for the vertical reticle to be level with the center of your rifle's bore. If this is not the case, canting of the rifle will occur and this will cause accuracy problems at long range.

One of the easiest ways to check vertical alignment is to use a vertical string line for example at about 10m in front of your rifle. Making sure your rifle is completely level, look through your March scope and confirm the vertical reticle is in line with the vertical string line.

At this point, use a torque wrench to tighten the scope ring screws.

Be sure to not over tighten the screws as this could also cause damage to your new March. Check that the scope has not moved as the screws are tightened.

Focus the Reticle

With your March scope securely installed on your rifle, it is now time to focus the reticle to your eyes.

With your scope at its lowest power setting, rotate the eyepiece counter-clockwise (when viewed from a normal shooting position) until the eyepiece moves freely. Looking through scope, aim at plain back ground such as the blue sky or a sheet of white paper.

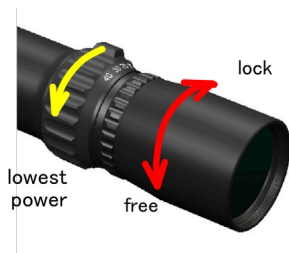

DO NOT ATTEMPT TO LOOK AT THE SUN, AS PERMANENT EYE DAMAGE WILL RESULT.

When you turn the eyepiece, the reticle's clarity will change as the focal length changes. When the reticle is focused for your eyes, turn the locking ring counter-clockwise until it is firm against the eyepiece.

Do not attempt to over tighten but it must be firm.

Eyepiece Adjustment Line

(Zoom Scopes except EP-Zoom)

The factory setting of the eyepiece is at -0.5 diopter. It is indicated with white line.

The adjustment to suit normal eyesight should not be too far from this position.

Once the eyepiece is set at the best position for your eyes, it isn't necessary to alter the setting often unless changing of visual acuity or user.

Rotate eyepiece lock ring and align it on the white line to set back to factory setting of the eyepiece.

The factory setting of the eyepiece is indicated with white line.



Sighting in your March Rifle Scope

The easiest way to sight in your March scope is to bore sight your rifle against a target located between for example 25 and 50 meters away. Bore sighting is easy. With your rifle securely rested and the bolt removed, look through the bore and move the rifle until you can see the target centered in the bore.

Without moving the rifle, look through the scope and adjust the windage and elevation setting to adjust the scope's reticle to the center of the target.

Fire a shot at the target and adjust the windage and elevation settings to move the reticle to the bullet's point of impact.

Turning the elevation dial towards "UP" moves the Point of Aim (POA) higher, while turning the dial towards "DN" moves the POA lower. Turning the windage dial towards "R" moves the POA to the right, while turning it to "L" moves the POA to the left.

After you have adjusted your scope to the point of impact, move the reticle back to the center of the target and fire another shot.

Repeat the adjustments to the windage and elevation dials until the point of aim meets the point of impact.

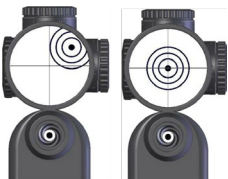

Important note:

Please check where your dials settings are after you have zeroed your rifle to the point of aim. The farther away the adjustments are from the central position (elevation and windage) the more optical resolution will degrade. Also you will not have available full amount of elevation or windage in one direction. So if your scope adjustment is set a long way off center to get the rifle zeroed this will indicate the alignment of the rifle bore is not at the same axis of the scope mount or base position.

Focus/Parallax adjustment

Your March Rifle Scope has a side focus dial that can be used to focus the scope on targets from approximately 10 yards to infinity.

The number on the dial is not an absolute reflection of the actual distance as this is affected by the user's eyesight and changing environmental factors.

It is critical, particularly for target shooting, that the setting be absolutely parallax free.

This means there should be no movement of the reticle relative to the target. To check this, move your head very slightly upwards and down or left to right and see that the reticle position does not move on the target. Be careful not to accidentally move your rifle when checking this.

The reticle should remain in the exact position aimed on the target as you slightly move your head position for parallax free operation. Adjust the focus dial until parallax free. If parallax movement is not completely removed you will have larger than usual grouping dispersion of your shots.



Side Focus dial



Side Focus Dial
Illumination Model

If the focus dial or zoom ring is stiff.

The side focus dial and zoom ring may be stiff to rotate due to lack of use or during cold weather. This is due to a settling of the lubricant on the airtight seals over time, or an increased viscosity in the lubricant at lower temperatures. Gently turning the dial back and forth will restore normal function.

Setting Elevation and Windage Zero

Customizing the windage and elevation zero on your new March scope is easy. Loosen the three set screws using the provided Allen wrench (see picture). Once loose, the dial should turn easily and you can set the dial to any position required. Retighten the set screws being careful not to over tighten them as damage may result.

Tactical type Dial

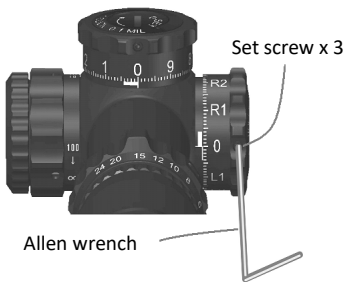

Normal type Dial



Zero Set Function

March-F and March-FX models have a Zero Set capability. After setting the elevation dial to the desired position,

hold the dial with your fingers and turn the “0-SET” Dial clockwise using a coin or correctly sized screw drive until the bottom stop is reached.

At this point the elevation cannot be lowered so that you will not lose your starting point.

If you do not need to use the Zero Set function, turn the “0-SET” dial counter-clockwise until it reaches the top of its travel.

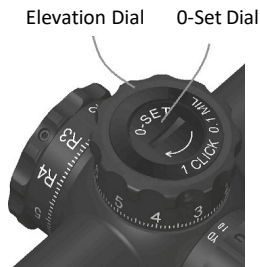

*Please note that the direction of rotation differs according to the model. Please refer to each product page for details.

For 4.5-28 × 52 and 1.5x-15x42, turn the “0-SET” Dial counterclockwise using a coin or correctly sized screw drive until the bottom stop is reached.

If you do not need to use the Zero Set function, turn the “0-SET” dial clockwise until it reaches the top of its travel.

Illuminating the Reticle

The Illumination Model (when fitted) on March scopes produces four levels of light intensity on the reticle for precision shooting in low light or night conditions. Pushing the rubber switch on the focusing dial activates the Illumination mode.

The Illumination Model cycles through OFF-1-2-3-4-OFF each time the switch is pressed.

The 4 setting is the brightest. The Illumination Model will automatically switch off after one hour to conserve battery life.



Rubber Tactical Switch

Changing the battery

in the Illumination Module

Turn the switch counter-clockwise to expose the battery compartment. Replace the battery with a lithium CR2032 battery. Pay special attention to the battery polarity: the positive (+) side of the battery must face the scope body.



Focusing Dial

Lithium Battery (CR2032)

Illumination Module Cap

Using the Zoom to change magnification

Turn the zoom ring clockwise to increase your scope's magnification and counter-clockwise to decrease magnification. Use the index point to select the most appropriate setting.



Zoom ring

Modifier Disk

30mm MD disk for 42mm objective lens

35mm MD disk for 52mm objective lens

43mm MD disk for 56mm objective lens

The Modifier Disk does not use any lenses. It is a lightweight aluminum disk with a smaller diameter hole in it to reduce the amount of light entering the scope.

The Modifier Disk screws onto the scope via the threads in front of the objective lens.

Using Modifier Disk with your March scope will:

a; reduce the amount of light entering the scope by as much as 50%(30mmMD disk), 50%(35mmMD disk), 40%(43mm MD disk).

(depending on the brightness of the conditions)

b; increase the depth of focus by up to 50%(30mm MD disk), 50%(35mm MD disk), 40%(43mmMD disk).

If unnecessary brightness is reduced and the focus depth increased, a user's ability in reading mirage is enhanced as the sight picture is more defined in difficult conditions.



For light reduction purposes, it is possible to use a camera filter on the eyepiece

($\text{Ø} = 37\text{mm}$, $P = 0.75$).

March recommends against using a filter on the objective lens because this affects target resolution.

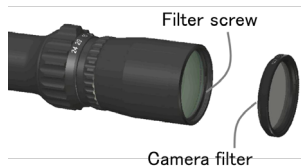

March™ Flip Cap



- a) Slide the correctly sized flip cap onto the eyepiece or objective end of the scope until it meets the inner edge of the cap. If the flip cap is difficult to install due to stiffness, warm it up first (only warm it slightly, do not apply direct heat).
- b) After flipping the cap open, push the cap down until it locks into the open position. Make sure to lock the cap open when using the scope.
- c) While flip caps protect against rain and dust, they are not waterproof. All March scopes are waterproof.

Parts No.	Item	Model
FC-41	41mm Flip cap for eyepiece	Eyepiece
FC-46	46mm Flip cap for eyepiece	Wide Angle Eyepiece
FC-33	33mm Flip cap for 24mm objective	1x-4x24, 1x-4.5x24, 1x-8x24, 1x-10x24
FC-51	51mm Flip cap for 42mm objective	2.5x-25x42, 3x-24x42, 1.5x-15x42
FC-60	60mm Flip cap for 52mm objective	48x52, 40x-60x52, 2.5x-25x52, 3x-24x52, 10x-60x52, 4.5-28x52, 4x-40x52
FC-64	64mm Flip cap for 56mm objective	5x-40x56, 5x-50x56, 8x-80x56, 10x-60x56, 5x-42x56, 6-60x56

Fast Lever

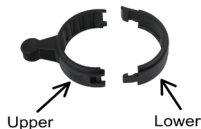

Wider nails



a) Firstly set the upper part of Fast Lever (with knob) on the scope magnification zoom ring.

Set the wider nails toward left. Set the lever knob right on the scope zoom ring knob. Make sure if the lever can fit on the scope zoom ring properly.



b) Next set the lower part of lever on the scope zoom ring.

Set the small hook of the lower part onto the windage side hook of the upper part.

Then set the bigger hook of the lower part onto the other side of the upper part until it clicks into place. It will be all set when the lever can fit and cover on the scope zoom ring completely.



How to remove the lever?

Once unhook the bigger hook of the lower part, all parts can be removed easily.

Manufacturing a March

Lens Design

March Rifle Scopes (except 1x-4x24, 1x-4.5x24, 1x-8x24 and 1x-10x24) use multi-coated Extra-low Dispersion (ED) lenses to reduce chromatic aberration and to provide high image resolution even at maximum magnification.

ED lenses have a smaller refractive index than typical optical lenses in the blue to red wavelength. This produces superior sharpness and color correction. ED lenses are often used in microscopes, high-end telescopes and semiconductors. ED lenses make it possible to maintain a consistent, high quality image from the lowest to highest magnification settings in your new March scope.

Internal Construction

March Rifle Scopes are made from specially heat-treated, high-grade aluminum, special alloy steel and brass. The scope body is filled with argon gas to create a stable environment. To ensure that March Scopes remain airtight, each scope is fitted with high performance, industrial grade rubber O-rings.

First Focal Plane (FFP) design;

A reticle placed in the first focal plane will keep the same value regardless of the magnification setting selected. This helps to simplify ranging targets and aiming off in difficult conditions. The reticle and the target will increase in size as the magnification is increased but any hash marks or divisions in the reticle pattern will retain a constant value.

For example, one Mil-Radian is a consistent measurement across the whole power range.

To determine what measurements are covered by your March's reticle, please refer to the reticle information contained at the end of this manual.



Low Magnification

High Magnification

March-F

Compact Zoom
1x-8x24mm
1x-8x24mm Shorty



(100yard fixed focus)

Windage and elevation markings

1 Click: 0.1Mil

1 Turn: 10Mil

Total adj. range: 56 Mil



Elevation dial

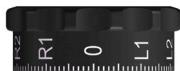

Windage dial



The Length

1x-8x24mm is 258mm

1x-8x24mm Shorty is 212mm

Reticle

FMC-1 Reticle

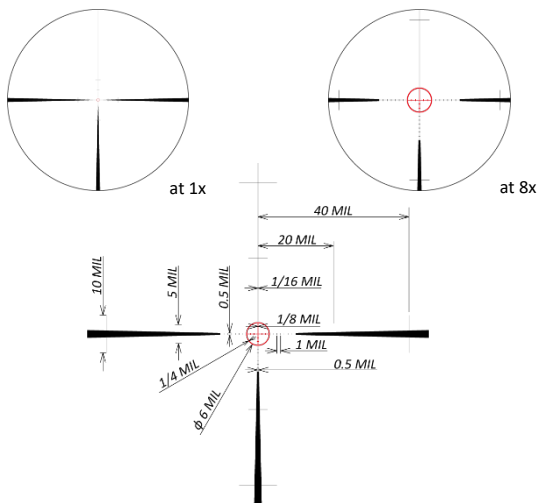

FMC-2 Reticle

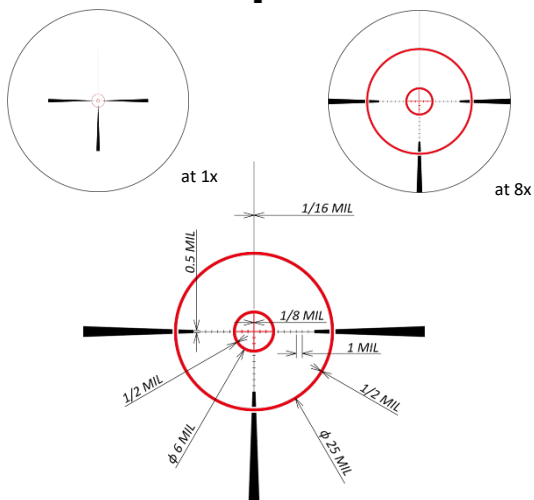

FMC-3 Reticle

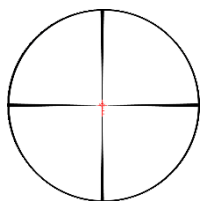

at 1x

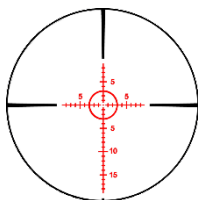

at 8x

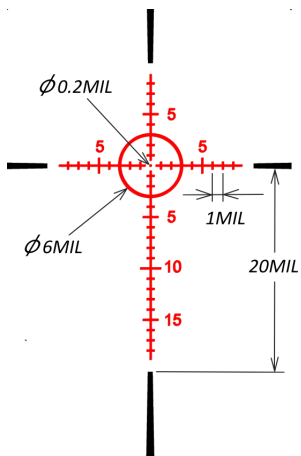

March-F Compact Zoom DR 1x-10x24mm Shorty



The March-F 1x-10x24mm Shorty is the world's lightest and shortest scope with 10 magnification ratio. The length is only 214mm(8.4 inch) and the weight is only 505g(17.8oz).

Windage and elevation markings

1 Click: 0.1Mil

1 Turn: 10Mil

Total adj. range: 56 Mil



Elevation dial

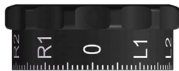

Windage dial

Dual Reticle

Illuminated center dot : 0.1MIL at 10x

DR-1

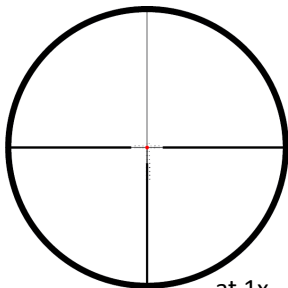

at 1x

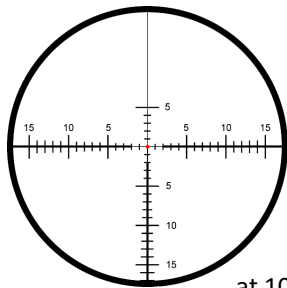

at 10x

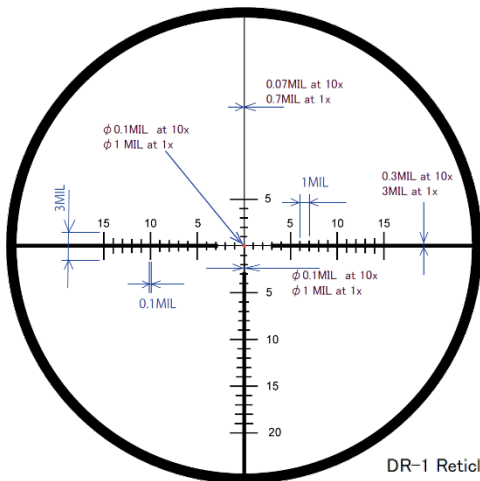

DR-1 Reticle

DR-TR1

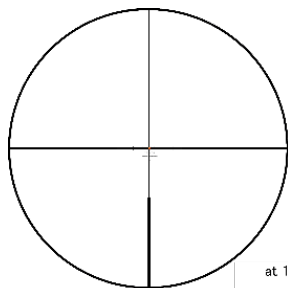

at 1x

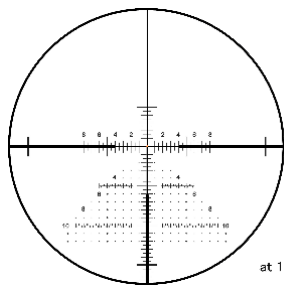

at 10x

DR-TR1 reticle

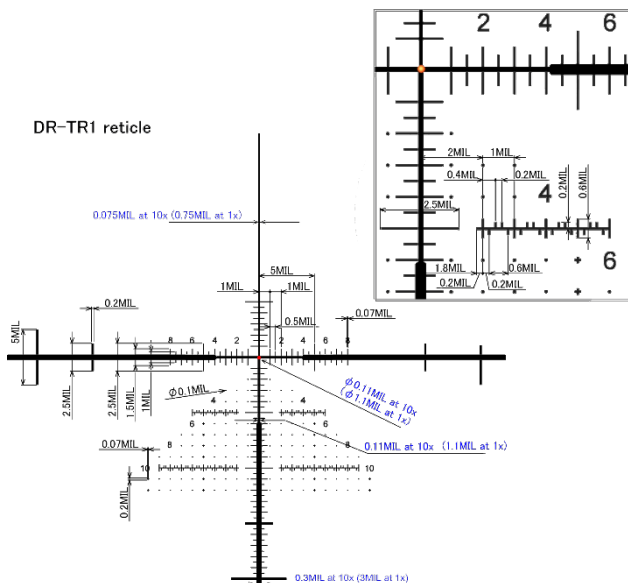

March-F

3x-24x42mm

3x-24x52mm



Mil model



MOA model



Windage and elevation markings:

Mil model
Elevation dial



1 Click: 0.1Mil
1 Turn: 10Mil

MOA model
Elevation dial



1 Click: 1/4MOA
1 Turn: 25MOA

Mil model
Windage dial

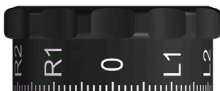

1 Click: 0.1Mil
1 Turn: 10Mil

MOA model
Windage dial



1 Click: 1/4MOA
1 Turn: 25MOA

Mil model [D24V42FML, D24V42FIML]
 [D24V52FML, D24V52FIML]

FML Reticle

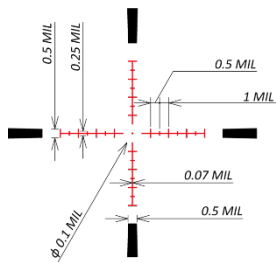
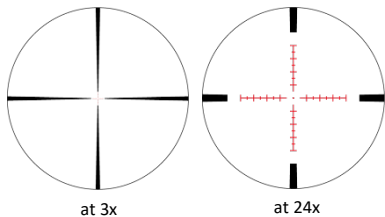

FML-1 Reticle

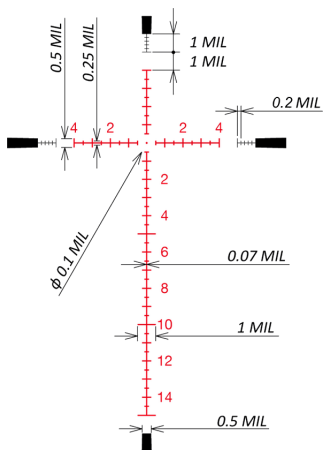
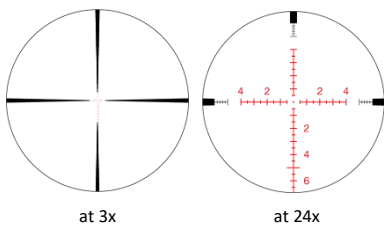

FML-T1 Reticle

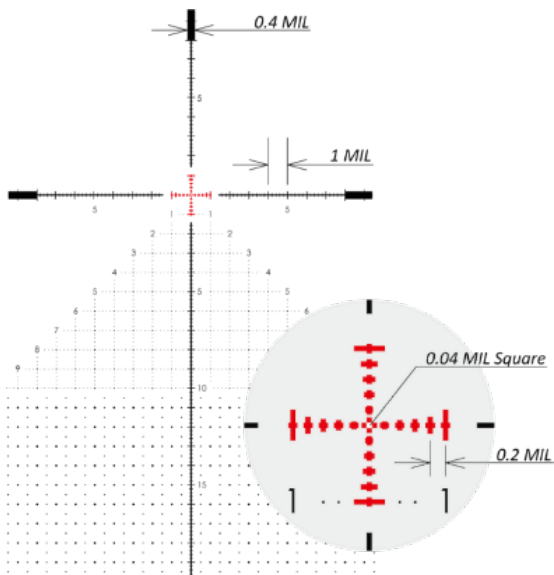
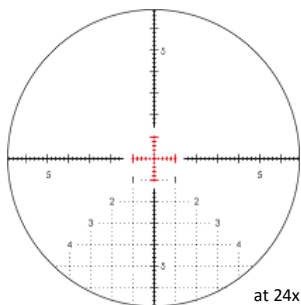
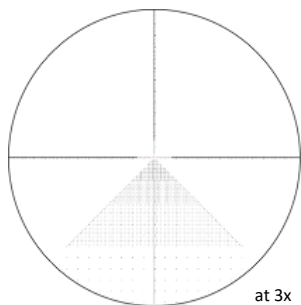

FML-TR1H Reticle

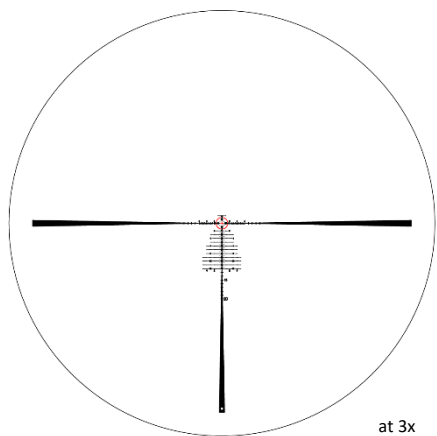

at 3x

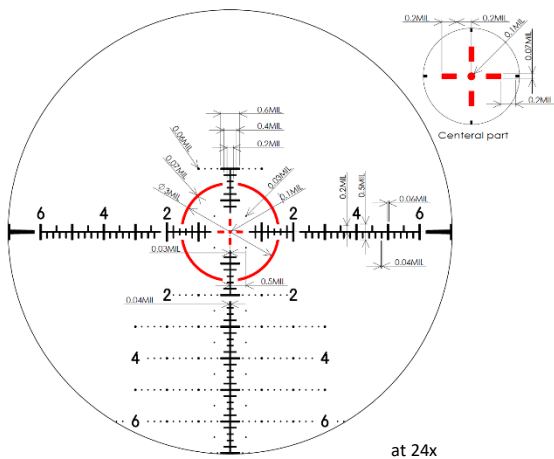

at 24x

MOA model

FMA-1 Reticle [D24V42FIMA, D24V52FIMA]

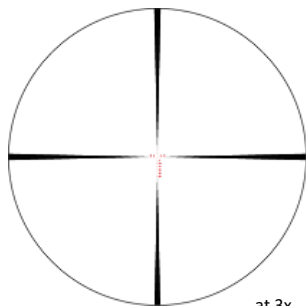

at 3x

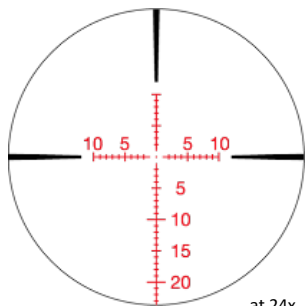

at 24x

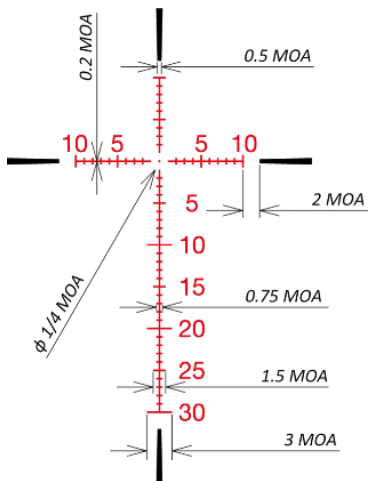

FMA-2 Reticle [D24V42FMA, D24V52FMA]

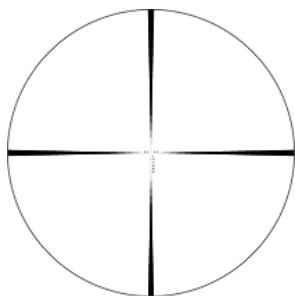

at 3x

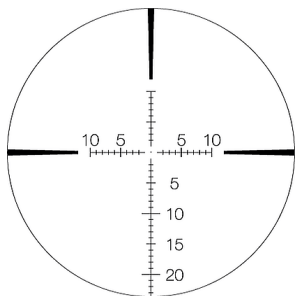

at 24x

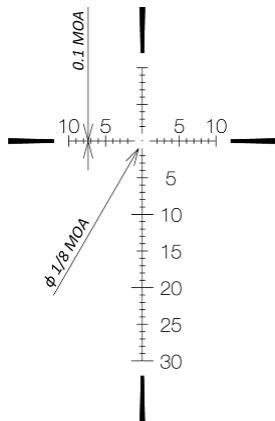

FMA-2 reticle is half as thick as FMA-1.

FMA-2 reticle cannot be fitted to illuminated models.

March-FX 5x-40x56mm



Windage and elevation markings:

Elevation dial

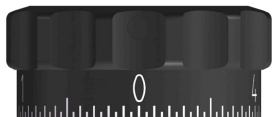

0.05Mil model dial
1 Click: 0.05Mil
1 Turn: 5Mil
Total adj. range: 24Mil

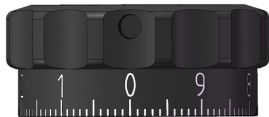

0.1Mil model dial
1 Click: 0.1Mil
1 Turn: 10Mil
Total adj. range: 24Mil



1/4MOA model dial
1 Click: 1/4MOA
1 Turn: 25MOA
Total adj. range: 66MOA

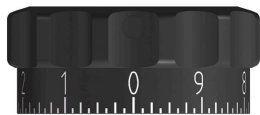

1/8MOA model dial
1 Click: 1/8MOA
1 Turn: 10MOA
Total adj. range: 66MOA

Windage dial



0.05Mil model dial
1 Click: 0.05Mil
1 Turn: 5Mil
Total adj. range: 12Mil



0.1Mil model dial
1 Click: 0.1Mil
1 Turn: 10Mil
Total adj. range: 12Mil



1/4MOA model dial
1 Click: 1/4MOA
1 Turn: 25MOA
Total adj. range: 38MOA

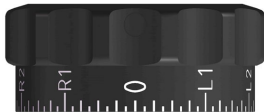

1/8MOA model dial
1 Click: 1/8MOA
1 Turn: 10MOA
Total adj. range: 38MOA

Reticle:

Mil model [D40V56FML, D40V56FIML]
[D40V56FML10, D40V56FIML10]

FML-1 Reticle

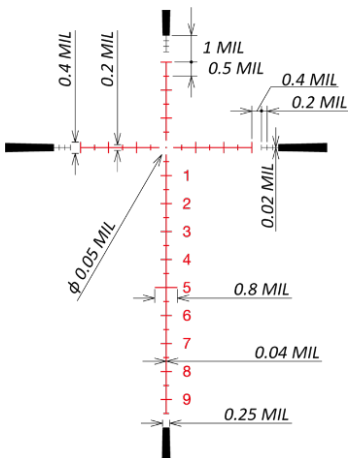
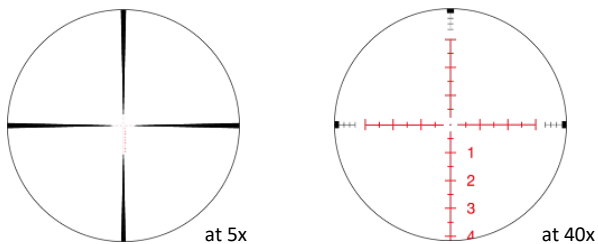

MOA model [D40V56FIMA4, D40V56FIMA8]

FMA-1 Reticle

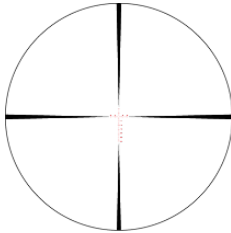

at 5x

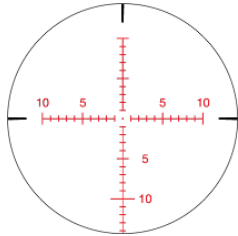

at 40x

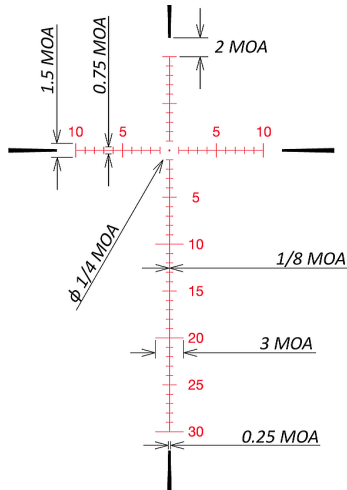

MOA model [D40V56FMA4, D40V56FMA8]

FMA-2 Reticle

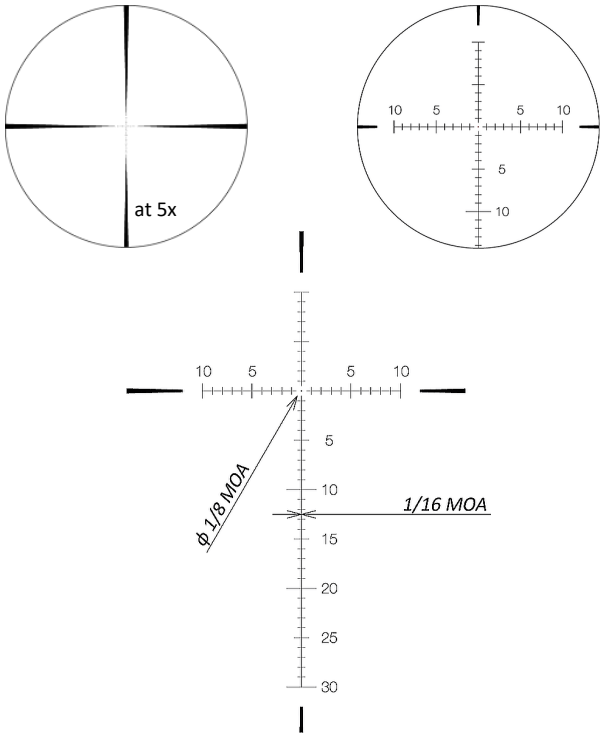

FMA-2 reticle is half as thick as FMA-1.

FMA-2 reticle cannot be fitted to illuminated models.

MarchFX

5x-40x56mm GEN-II



Windage and elevation markings:

Elevation dial



0.05Mil model dial
1 Click: 0.05Mil
1 Turn: 5Mil
Total adj. range: 24Mil



0.1Mil model dial
1 Click: 0.1Mil
1 Turn: 10Mil
Total adj. range: 24Mil



1/8MOA model dial
1 Click: 1/8MOA
1 Turn: 10MOA
Total adj. range: 66MOA

Windage dial



0.05Mil model dial
1 Click: 0.05Mil
1 Turn: 5Mil
Total adj. range: 12Mil



0.1Mil model dial
1 Click: 0.1Mil
1 Turn: 10Mil
Total adj. range: 12Mil



1/8MOA model dial
1 Click: 1/8MOA
1 Turn: 10MOA
Total adj. range: 38MOA

Elevation Dial Locking Mechanism

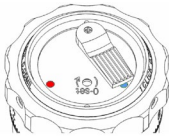

Dial Unlock

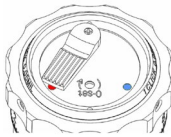

Dial Lock

When setting the Lock Lever on top of the Dial at the red mark, the Dial will be locked.

When setting the Lock Lever on top of the Dial at the blue mark, the Dial will be unlocked.

O-Set

After setting the Elevation Dial at the desired position, screw in the hexagon socket screw on top of the Dial until it stops. Elevation Dial can only be used in the Upward direction than that position.

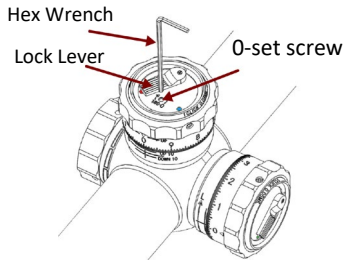

Focus/Parallax adjustment

Side focus dial that can be used to focus the scope on targets from approximately 10 yards to infinity. It is critical, particularly for target shooting, that the setting be absolutely parallax free.

Side Focus Dial



Illuminated model



Non-Illuminated model

This means there should be no movement of the reticle relative to the target. To check this, move your head very slightly upwards and downwards or left to right and see that the reticle position does not move on the target. Be careful not to accidentally move your rifle when checking this.

Fast focus eyepiece

This Fast Focus Eyepiece is capable of adjusting ± 2 diopter in a single turn. Hence this enables prompt adjustment for the Eyepiece.



Focus the Reticle

With your March scope securely installed on your rifle, it is now time to focus the reticle to your eyes.

With your scope at its lowest power setting, rotate the eyepiece counter-clockwise (when viewed from a normal shooting position) until the eyepiece moves freely. When looking through the scope, aim at plain back ground such as the blue sky or a sheet of white paper. When you turn the eyepiece, the reticle's clarity will change as the focal length changes. When the reticle is focused for your eyes, turn the locking ring counter-clockwise until it is firm against the eyepiece. Do not attempt to over tighten but it must be firm.

DO NOT ATTEMPT TO LOOK AT THE SUN, AS PERMANENT EYE DAMAGE WILL RESULT.

Six Level Illumination switch

By rotating the dial, the shooter can change the brightness from six levels. 1 is the darkest and 6 is the brightest.

The rubber switch turns illumination on or off while maintaining the selected brightness level.

The illumination switch will automatically shut down after one hour of no use . When turning on the switch after being turned off, it will illuminate in the previously selected brightness level.



Dark-----Bright
1 • 2 • 3 • 4 • 5 • 6

Reticle:

Mil model [D40V56FML-G2, D40V56FIML-G2]
[D40V56FML10-G2, D40V56FIML10-G2]

FML-1 Reticle

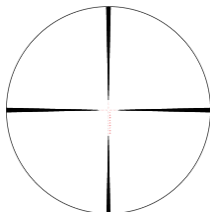

at 5x

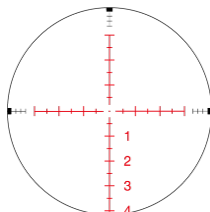

at 40x

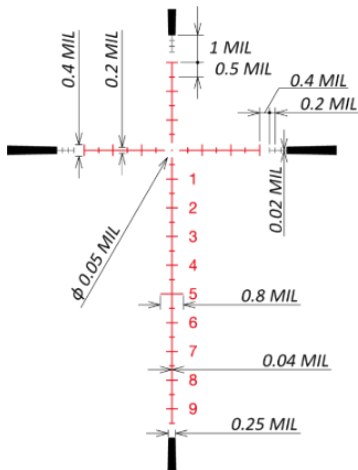

Reticle:

Mil model [D40V56FML-G2, D40V56FIML-G2]
[D40V56FML10-G2, D40V56FIML10-G2]

FML-PDKI Reticle

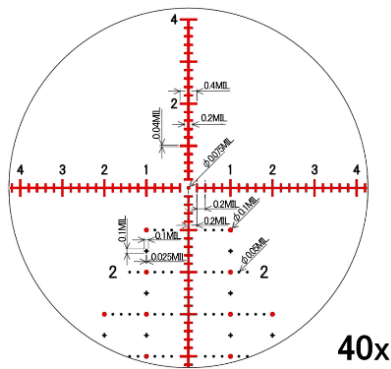
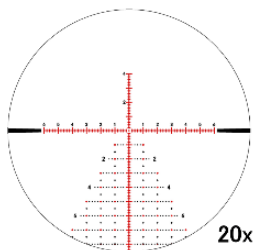
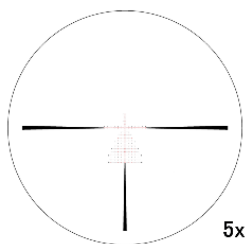

MOA model [D40V56FIMA8-G2]

FMA-1 Reticle

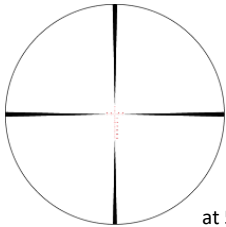

at 5x

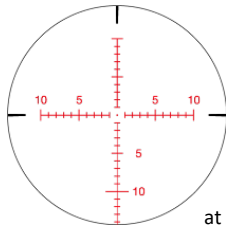

at 40x

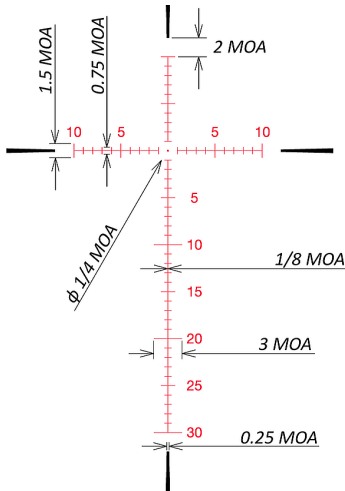

MOA model [D40V56FMA8-G2]

FMA-2 Reticle

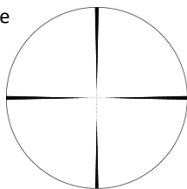

at 5x

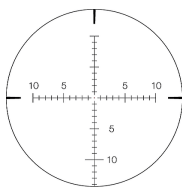

at 40x

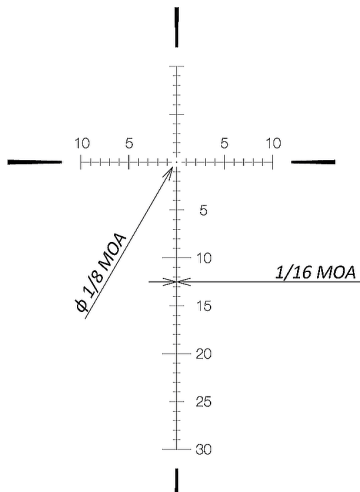

FMA-2 reticle is half as thick as FMA-1.

MarchFX 4.5x-28x52mm 34mm Tube



First Focal Plane Scope with 6.2 Magnification Ratio incorporates High Master optical system combined with a thermal construction. This 4.5-28x52 scope guarantees superb image quality and focus stability across a broad range of temperatures.

25 Degree Wide Angle (Large Eye Box) Eyepiece will enhance FOV throughout the 6.2 magnification range. Fast pitch eyepiece setting comes in handy when the time is the essence.



Windage and elevation markings:

Elevation dial



0.1Mil model dial
1 Click: 0.1Mil
1 Turn: 10Mil
Total adj. range: 30Mil

Windage dial with cap



0.1Mil model dial
1 Click: 0.1Mil
1 Turn: 10Mil
Total adj. range: 20Mil





Zero Set Function

March-FX 4.5x-28x52 models have a Zero Set capability. After setting the elevation dial to the desired position, hold the dial with your fingers and turn the “0-SET” Dial counter-clockwise using a coin or correctly sized screw driver until the bottom stop is reached.

At this point the elevation cannot be lowered so that you will not lose your starting point.

If you do not need to use the Zero Set function, turn the “0-SET” dial clockwise until it reaches the top of its travel.

For light reduction purposes, it is possible to use a camera filter on the eyepiece ($\text{Ø} = 43\text{mm}$, $\text{P} = 0.75$).

March recommends against using a filter on the objective lens because that affects target resolution.



Filter screw

FML-TR1
Mil model

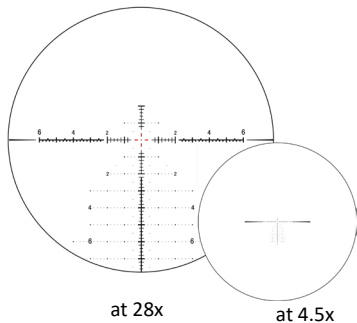

FML-3
Mil model

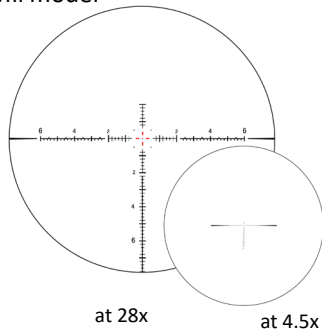

FML-3 & TR1 reticle subtensions

4.5-28x52
FML-TR1

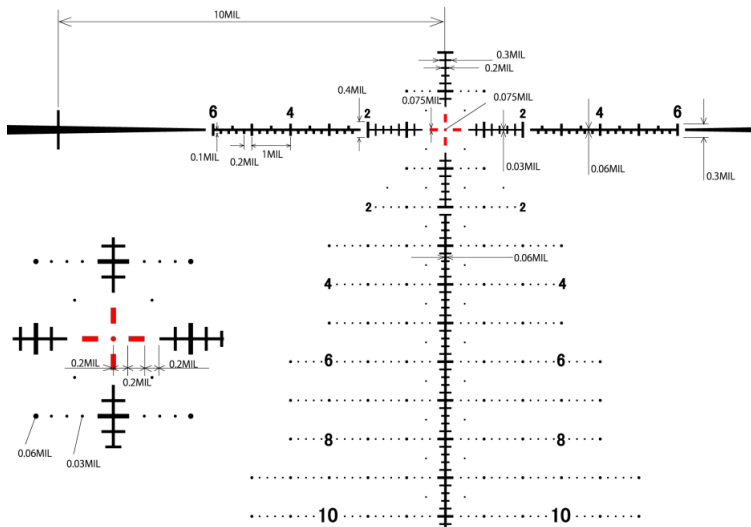

FML-PDK
Mil model
Non-Illumi

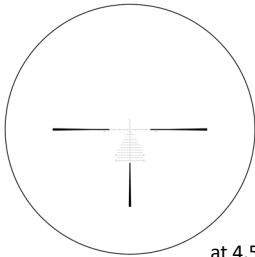

at 4.5x

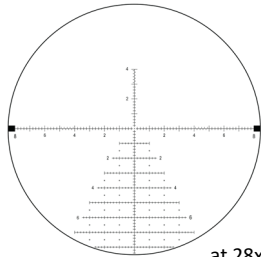

at 28x

FML-LDK
Mil model
Non-Illumi

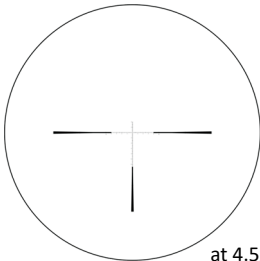

at 4.5x

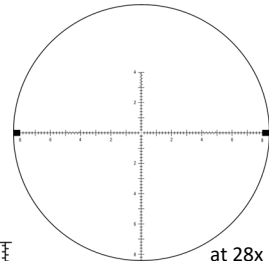

at 28x

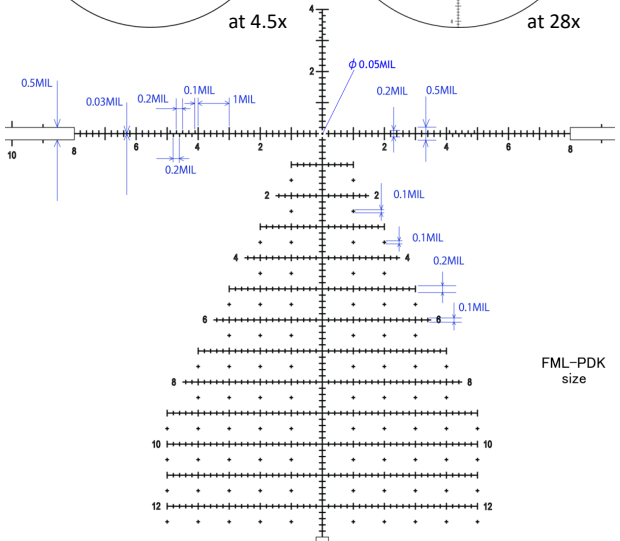

MarchFX 5x-42x56mm

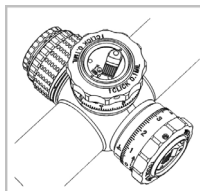

Windage and elevation markings:

Elevation dial

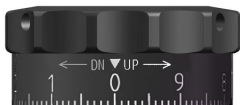

0.1Mil model dial
1 Click: 0.1Mil
1 Turn: 10Mil
Total adj. range: 40Mil

Windage dial

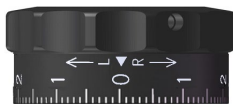

0.1Mil model dial
1 Click: 0.1Mil
1 Turn: 10Mil
Total adj. range: 14Mil



1/4MOA model dial
1 Click: 1/4MOA
1 Turn: 25MOA
Total adj. range: 130MOA



1/4MOA model dial
1 Click: 1/4MOA
1 Turn: 25MOA
Total adj. range: 48MOA

“NOTE:

This riflescope has an internal adjustment range of 40MIL; 20 up, 20 down (130MOA; 75 up, 75 down). In any riflescope the best image quality is at or near the center of the adjustments. Because of the very wide adjustment range of this riflescope, you may experience some image quality degradation as you near the limits of the adjustment range. This can occur because of the extreme refraction of the incoming light at the edges of the objective lens. This degradation will worsen as the magnification increases.

Therefore, we recommend using an appropriate canted rail if you plan to use this riflescope consistently near the limits of the adjustment range and at higher magnification. It can be utilised to gain additional elevation and to keep the scope optically centred as much as possible.

A 20MOA rail will shift the adjustment range by about 5.7MIL to 25.7MIL up and 14.3MIL down.

A 30MOA rail will shift the adjustment range by about 8.6MIL to 28.6MIL up and 11.4MIL down.

Dial Locking Mechanism

Elevation Dial

Windage Dial

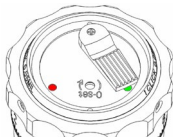
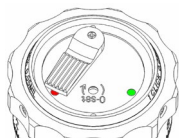
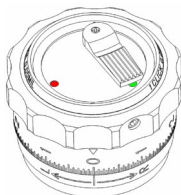

Dial Lock

Dial Unlock

When setting the Lock Lever on top of the Dial at the red mark, the Dial will be locked.

When setting the Lock Lever on top of the Dial at the green mark, the Dial will be unlocked.

0-Set

After setting the Elevation Dial at the desired position, screw in the hexagon socket screw on top of the Dial until it stops. Elevation Dial can only be used in the Upward direction than that position.

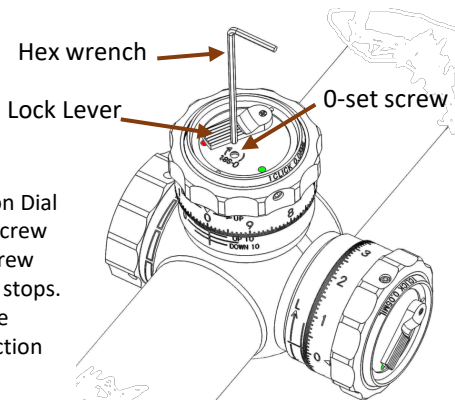

Focus Dial Locking Mechanism

By adopting the focus dial locking system, it avoids the focus dial to be turned unexpectedly and being out of focus.



When pushing in the focus dial to the red direction, it will lock as in the right figure.

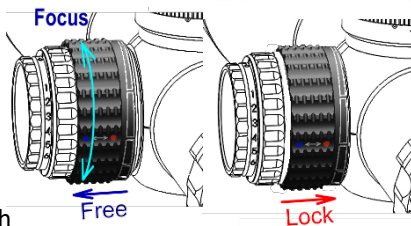

When pulling it out to the blue direction, it will be unlocked.

Six Level Illumination switch

By rotating the dial, the shooter can change the brightness from six levels. 1 is the darkest and 6 is the brightest.

The rubber switch turns illumination on or off while maintaining the selected brightness level.

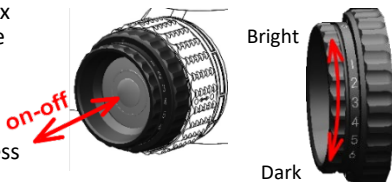

The illumination switch will automatically shut down after one hour of no use as with the four level illumination switch.

When turning on the switch after being turned off, it will illuminate in the previously selected brightness level.

Dark-----Bright
1 • 2 • 3 • 4 • 5 • 6

In order to change the battery (please refer to the left figure), turn the switch counter-clockwise to open the battery compartment and then replace the battery with a lithium battery (CR2032). The flat surface of the battery (+) must face the scope body. After replacing the battery, please lock in the switch by turning it clockwise.



Fast focus & Wide angle Eyepiece

This Fast Focus Eyepiece is capable of adjusting ± 2 diopter in a single turn. Hence this enables prompt adjustment for the Eyepiece.

With this 26 Degree Wide Angle Eyepiece, you will be able to aim the target / game with a wide view.

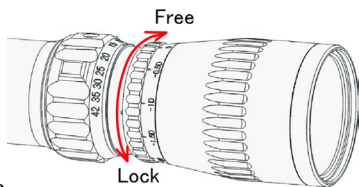

Focus the Reticle

With your March scope securely installed on your rifle, it is now time to focus the reticle to your eyes.

With your scope at its lowest power setting, rotate the eyepiece counter-clockwise (when viewed from a normal shooting position) until the eyepiece moves freely. Looking through scope, aim at plain back ground such as the blue sky or a sheet of white paper.

DO NOT ATTEMPT TO LOOK AT THE SUN, AS PERMANENT EYE DAMAGE WILL RESULT.

When you turn the eyepiece, the reticle's clarity will change as the focal length changes. When the reticle is focused for your eyes, turn the locking ring counter-clockwise until it is firm against the eyepiece.

Do not attempt to over tighten but it must be firm.

FML-MT Mil Model (Illuminated)

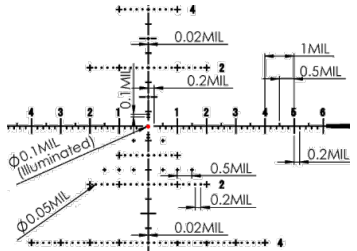
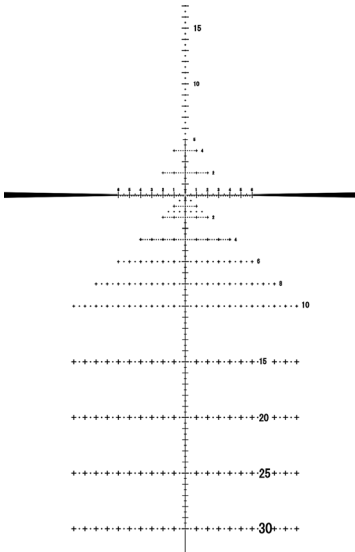
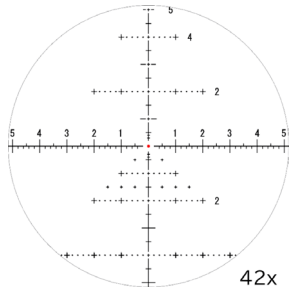
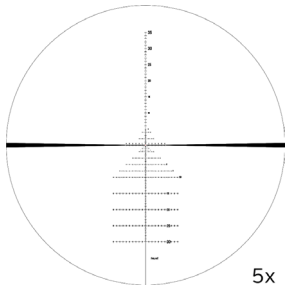

FML-TR1
Mil model

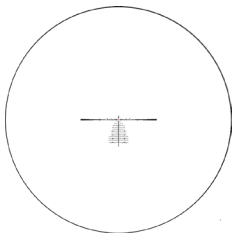

FML-3
Mil model

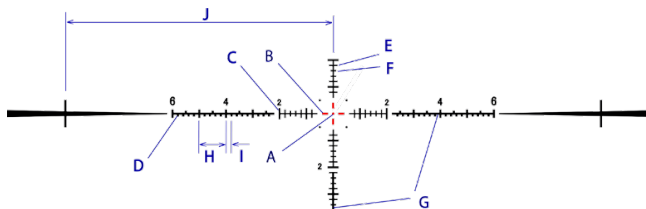
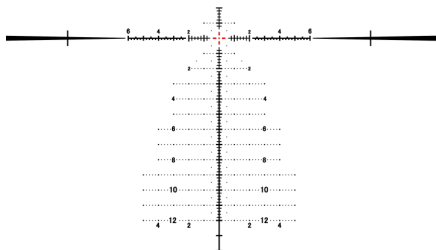
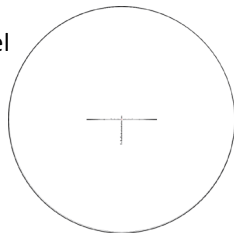

FML-3 & TR1 reticle subtensions

- A: 0.06Mil
- B: 0.06
- C: 0.4
- D: 0.1
- E: 0.3
- F: 0.2
- G: 0.05
- H: 1
- I: 0.2
- J: 10

FMA-MT MOA Model (Illuminated)

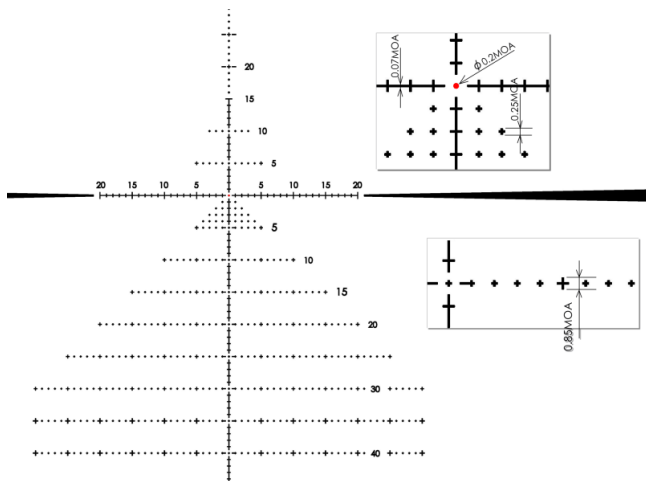
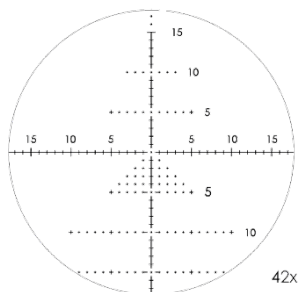
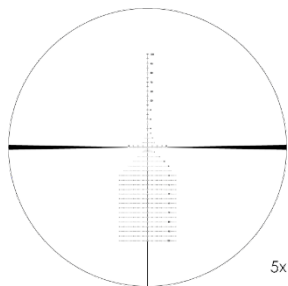

FMA-TR1 MOA model

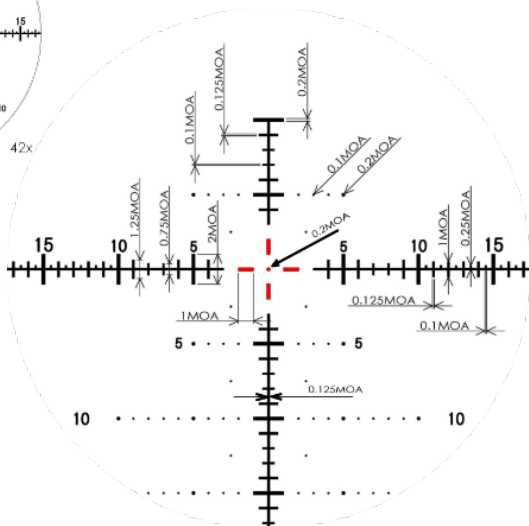
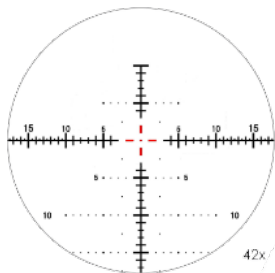
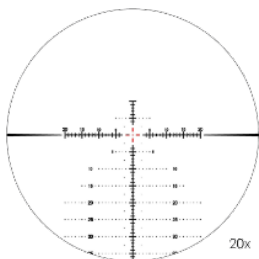
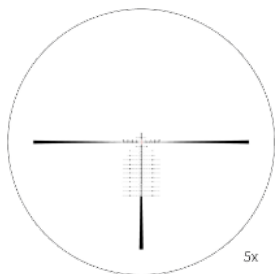

FMA-3 MOA model

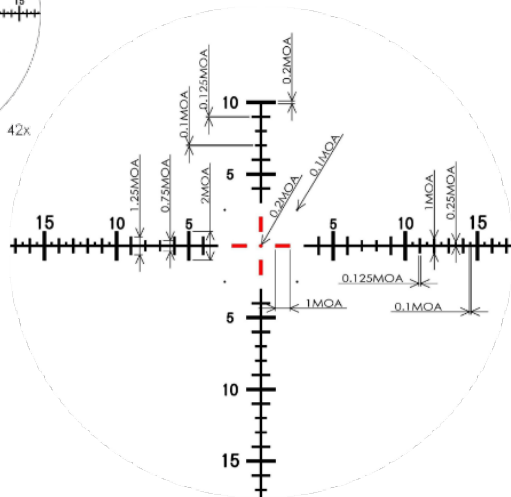
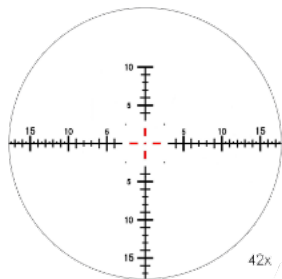
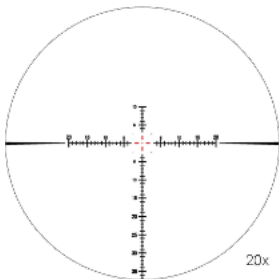
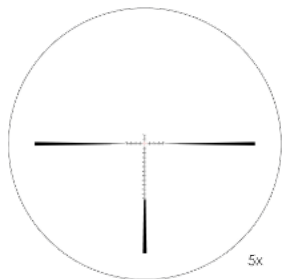

March-FX How to adjust 5-42x56

High Master
Wide Angle



By shortening the objective focal length of 5-42×56, we were able to realize a great amount of elevation travel compared with other scopes which has the same 34mm body tube diameter.

cf. 5-40×56 : 22MIL/76MOA, 5-50×56 & 10-60×56 & 8-80×56 : 60MOA (equivalent to about 17.1MIL)

This 5-42×56 has 40MIL (equivalent to about 140MOA) which has the most travel amount among all the 34mm body tube diameter March scopes.

However the focal depth will be shallower due to short objective focal length, and this will require finer adjustments for the side focus. In case you find the image to blur, please readjust by following.

- 1) Please set the magnification at 5x.

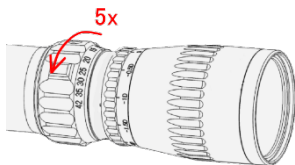

- 2) Rotate the eyepiece and find the spot where you can see the reticle the best. Please check below to see how to properly adjust the diopter.

<https://marchscopes.com/news/4946/>



- 3) When you find the position where you can see the best, rotate the stop ring and stabilize the eyepiece. You only need to set the eyepiece once to suit your diopter.

- 4) Please set the magnification at 42x.

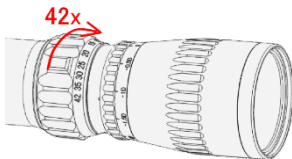

5) Adjust the side focus and bring the target into focus.

* When you rotate the elevation, focus may shift. In this case, please readjust the side focus turret.

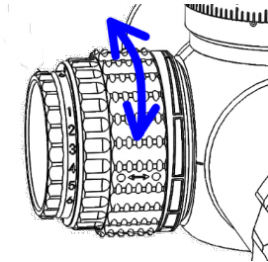

In any riflescope the best image quality is at or near the center of the adjustments.

Because of the very wide adjustment range of this riflescope, you may experience some image quality degradation as you near the limits of the adjustment range.

This can occur because of the extreme refraction of the incoming light at the edges of the objective lens.

This degradation will worsen as the magnification increases but if you readjust the focus turret each time, you will be able to see the image clearly.

In case you do not wish to adjust each time, we recommend using an appropriate canted rail if you plan to use this riflescope consistently near the limits of the adjustment range and at higher magnification. It can be utilized to gain additional elevation and to keep the scope optically centered as much as possible.

A 20MOA rail will shift the adjustment range by about 5.7MIL to 25.7MIL up and 14.3MIL down.
A 30MOA rail will shift the adjustment range by about 8.6MIL to 28.6MIL up and 11.4MIL down.

== Caution ! ==



Dial Lock



Dial Unlock

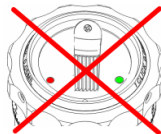

Elevation and Windage dial locking mechanism

Please set the Lock Lever on top of the dial to either the green or the red mark as far as it will go. If you rotate the dial with the Lock lever **set at the red mark or between the green and the red mark**, the locking system will be damaged. Please make sure **that the lock lever is set** at the correct position.

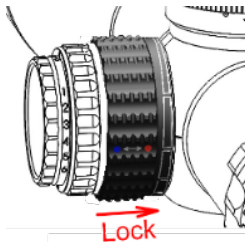
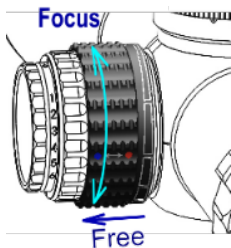

Focus dial locking mechanism

When you lock the focus dial, please push it in as far as it will go. When you unlock the focus dial, please pull it out as far as it will go. If you rotate the focus dial in between **or at a locked position**, the locking system will be damaged. Please make sure to rotate the focus dial at the correct position.

(Note)

The aim of the Locking mechanism of Elevation, Windage, Side focus dials is to prevent the dials from accidentally rotating while on the move during competitions or hunting. As the lock is not stiff, if you rotate the dials at incorrect positions with strong force it may lead to the damage of the locking system. Also once the dials are in a locked position, please make sure not to rotate them.

If any accident or misuse of the locking Elevation, Windage and Focus dials lead to the damage of the locking system, DEON will repair it for a fee. By any chance the locking system may damage, it will not affect other than the locking mechanism itself. Dials can be used and E/W dials will still track correctly.



1x-8x24 FFP Scope				
SPECIFICATIONS				
Model No.		D8V24FML	D8V24FIML	D8SV24FIML
Magnification	Low	1x		
	High	8x		
Effective Lens Diameter		24mm		
Exit Pupil		High 3mm		
Field of View real	Degree	Low 19.67°		
		High 2.46°		
	ft/Yd	Low 104ft/100Yd (34.67m/100m)		
		High 12.9ft/100Yd (4.30m/100m)		
Eye Relief		Low 74-102mm		
		High 74-97mm		
1 Click Value		0.1 Mil		
1 Turn travel		10 Mil		
Elevation Travel		56 Mil		
Windage Travel		56 Mil		
Focus		Side Focus/Parallax		Fixed
Distance		10yd-Infinity		100yd
Finish		Matte Black		
Illumination		-	Illumination	Illumination
Reticle		FMC-1, FMC-2, FMC-3		
Body Tube Diameter		30mm		
Weight		530g(18.7oz)	560g(19.8oz)	485g(17.1oz)

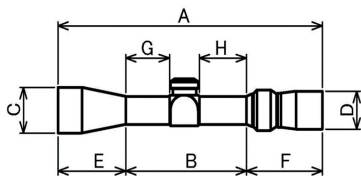

	1x-8x24	1x-8x24Shorty
A	258mm (10.2inch)	212mm (8.3inch)
B	129mm (5.1inch)	83mm (3.3inch)
C	33mm (1.3inch)	33mm (1.3inch)
D	41mm (1.6inch)	41mm (1.6inch)
E	35mm (1.4inch)	35mm (1.4inch)
F	94mm (3.7inch)	94mm (3.7inch)
G	49mm (1.9inch)	3mm (0.11inch)
H	42mm (1.7inch)	42mm (1.7inch)



1x-10x24 FFP Scope			
SPECIFICATIONS			
Model No.		D10SV24FIML (Tactical turrets)	D10SV24FIMLN (Capped turrets)
Magnification	Low	1x	
	High	10x	
Effective Lens Diameter		24mm	
Exit Pupil	Low	8.6mm	
	High	2.4mm	
Field of View real	Degree	Low	19.2°
		High	1.92°
	ft/Yd	Low	101.5ft/100Yd (33.83m/100m)
		High	10.05ft/100Yd (3.35m/100m)
Eye Relief	Low	72-104mm	
	High	75-100mm	
1 Click Value		0.1 Mil	
1 Turn travel		10 Mil	
Elevation Travel		56 Mil	
Windage Travel		56 Mil	
Focus		Side Focus/Parallax	
Distance		10yd-Infinity	
Finish		Matte Black	
Illumination		Illumination	
Reticle		DR-1, DR-TR1	
Body Tube Diameter		30mm	
Weight		505g(17.8oz)	

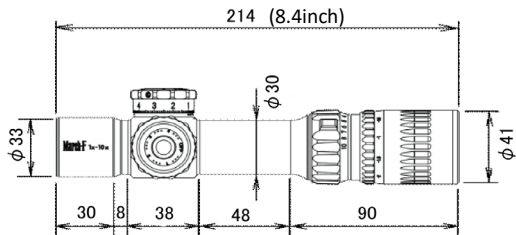



3x-24x42 FFP Scope SPECIFICATIONS					
		MIL model		MOA model	
Model No.		D24V42FML	D24V42FIML	D24V42FMA	D24V42FIMA
Magnification	Low	3x			
	High	24x			
Effective Lens Diameter		42mm			
Exit Pupil		High 1.75mm			
Field of View real	Degree	Low 6.67°			
		High 0.83°			
	ft/Yd	Low 35ft/100Yd (11.66m/100m)			
		High 4.3ft/100Yd (1.45m/100m)			
Eye Relief		Low 85-100mm			
		High 89-96mm			
1 Click Value		0.1 Mil		1/4 MOA	
1 Turn travel		10 Mil		25 MOA	
Elevation Travel		28 Mil		100 MOA	
Windage Travel		28 Mil		100 MOA	
Focus		Side Focus/Parallax			
Distance		10yd-Infinity			
Finish		Matte Black			
Illumination		-	Illumination	-	Illumination
Reticle		FML FML-1 FML-T1 FML-TR1H	FML FML-1 FML-T1 FML-TR1H	FMA-2	FMA-1
Body Tube Diameter		30mm			
Weight		610g (21.5oz)	640g (22.6oz)	610g (21.5oz)	640g (22.6oz)

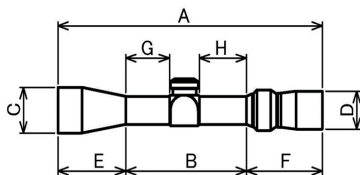

	3x-24x42
A	312mm (12.3inch)
B	139mm (5.5inch)
C	51mm (2.0inch)
D	41mm (1.6inch)
E	81mm (3.2inch)
F	92mm (3.6inch)
G	53mm (2.1inch)
H	48mm (1.9inch)



3x-24x52 FFP Scope SPECIFICATIONS					
		MIL model		MOA model	
Model No.		D24V52FML	D24V52FIML	D24V52FMA	D24V52FIMA
Magnification	Low	3x			
	High	24x			
Effective Lens Diameter		52mm			
Exit Pupil	High	2.17mm			
Field of View real	Degree	Low	6.6°		
		High	0.83°		
	ft/Yd	Low	35ft/100Yd (11.66m/100m)		
		High	4.3ft/100Yd (1.45m/100m)		
Eye Relief	Low	85-100mm			
	High	89-96mm			
1 Click Value		0.1 Mil		1/4 MOA	
1 Turn travel		10 Mil		25 MOA	
Elevation Travel		34 Mil		120 MOA	
Windage Travel		17 Mil		60 MOA	
Focus		Side Focus/Parallax			
Distance		10yd-Infinity			
Finish		Matte Black			
Illumination		-	Illumination	-	Illumination
Reticle		FML FML-1 FML-T1 FML-TR1H	FML FML-1 FML-T1 FML-TR1H	FMA-2	FMA-1
Body Tube Diameter		30mm			
Weight		665g (23.3oz)	695g (24.3oz)	665g (23.3oz)	695g (24.3oz)

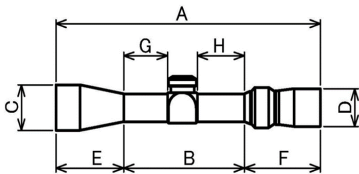

	3x-24x52
A	336mm (13.2inch)
B	139mm (5.5inch)
C	60mm (2.4inch)
D	41mm (1.6inch)
E	105mm (4.1inch)
F	94mm (3.7inch)
G	53mm (2.1inch)
H	48mm (1.9inch)



4.5x-28x52 FFP Scope SPECIFICATIONS			
		MIL model	
Model No.		D28HV52WFIML	D28HV52WFML
Magnification	Low	4.5x	
	High	28x	
Effective Lens Diameter		52mm	
Exit Pupil	High	1.86mm	
Field of View real	Degree	Low	5.56°
		High	0.892°
	ft/Yd	Low	29.1ft/100Yd (9.7m/100m)
		High	4.68ft/100Yd (1.56m/100m)
Eye Relief	Low	70-93.7mm	
	High	72-90mm	
1 Click Value		0.1 Mil	
1 Turn travel		10 Mil	
Elevation Travel		30 Mil	
Windage Travel		20 Mil	
Focus		Side Focus/Parallax	
Distance		10yd-Infinity	
Finish		Matte Black	
Illumination		Illumination	-
Reticle	FML-3		FML-PDK
	FML-TR1		FML-LDK
Body Tube Diameter		34mm	
Weight		845g (29.8oz)	815g (28.7oz)

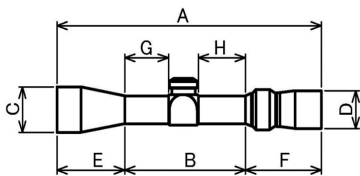

	4.5x-28x52
A	318mm (12.5inch)
B	129mm (5.0inch)
C	60mm (2.4inch)
D	46mm (1.8inch)
E	93mm (3.7inch)
F	96mm (3.8inch)
G	42mm (1.6inch)
H	49mm (1.9inch)



5x-40x56 FFP Scope SPECIFICATIONS									
		0.05MIL		0.1MIL		1/4 MOA		1/8 MOA	
Model No.		D40V56FML	D40V56FIML	D40V56FML10	D40V56FIML10	D40V56FMA4	D40V56FIMA4	D40V56FMA8 D40V56FIMA8	
Magnification	Low	5x							
	High	40x							
Effective Lens Dia.		56mm							
Exit Pupil		High		1.4mm					
Field of View real	Degree	Low		4°					
		High		0.5°					
	ft/Yd	Low		21ft/100Yd (6.98m/100m)					
		High		2.6ft/100Yd (0.87m/100m)					
Eye Relief		Low		96-100mm					
		High		92-98mm					
1 Click Value		0.05MIL		0.1MIL		1/4 MOA		1/8 MOA	
1 Turn travel		5 Mil		10MIL		25MOA		10MOA	
Elevation Travel		24 Mil				66MOA			
Windage Travel		12 Mil				38MOA			
Focus		Side Focus/Parallax							
Distance		10yd-Infinity							
Finish		Matte Black							
Illumination		-	Illumi	-	Illumi	-	Illumi	-	Illumi
Reticle		FML-1	FML-1	FML-1	FML-1	FMA-2	FMA-1	FMA-2	FMA-1
Body Tube Diameter		34mm							
Weight		860g (30.3oz)	890g (31.4oz)	860g (30.3oz)	890g (31.4oz)	860g (30.3oz)	890g (31.4oz)	860g (30.3oz)	890g (31.4oz)

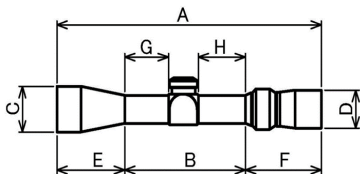

5x-40x56	
A	387mm (15.2inch)
B	155mm (6.1inch)
C	64mm (2.5inch)
D	41mm (1.6inch)
E	144mm (5.7inch)
F	88mm (3.5inch)
G	66mm (2.6inch)
H	52mm (2.0inch)



		0.05MIL		0.1MIL		1/8 MOA	
Model No.		D40V56FML-G2	D40V56FML-G2	D40V56FML10-G2	D40V56FML10-G2	D40V56FMA8-G2	D40V56FMA8-G2
Magnification	Low	5x					
	High	40x					
Effective Lens Dia.		56mm					
Exit Pupil		High 1.4mm					
Field of View real	Degree	Low 4°					
		High 0.5°					
	ft/Yd	Low 21ft/100Yd (6.98m/100m)					
		High 2.6ft/100Yd (0.87m/100m)					
Eye Relief	Low	96-100mm					
	High	92-98mm					
1 Click Value		0.05MIL		0.1MIL		1/8 MOA	
1 Turn travel		5 Mil		10MIL		10MOA	
Elevation Travel		24 Mil				66MOA	
Windage Travel		12 Mil				38MOA	
Focus		Side Focus/Parallax					
Distance		10yd-Infinity					
Finish		Matte Black					
Illumination		-	Illumi	-	Illumi	-	Illumi
Reticle		FML-1 FML-PDKI	FML-1 FML-PDKI	FML-1 FML-PDKI	FML-1 FML-PDKI	FMA-2	FMA-1
Body Tube Diameter		34mm					
Weight		915g (32.3oz)	950g (33.5oz)	915g (32.3oz)	950g (33.5oz)	915g (32.3oz)	950g (33.5oz)

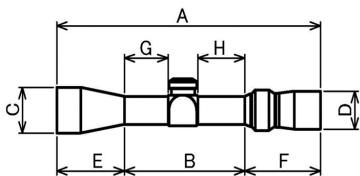

	5x-40x56-G2
A	387mm (15.2inch)
B	155mm (6.1inch)
C	64mm (2.5inch)
D	41mm (1.6inch)
E	144mm (5.7inch)
F	88mm (3.5inch)
G	66mm (2.6inch)
H	52mm (2.0inch)



March-FX 5x-42x56HM SPECIFICATIONS			
		MIL model	MOA model
Model No.		D42HV56WFIML	D42HV56FWFIMA
Magnification	Low	5x	
	High	42x	
Effective Lens Diameter		56mm	
Exit Pupil	Low	5.2mm	
	High	1.33mm	
Field of View	Degree	Low	5.2°
		High	0.62°
	ft/Yd	Low	26.19ft/100Yds
		High	3.25ft/100Yds
Eye Relief	Low	71-90.4mm	
	High	74.2-90mm	
1 Click Value		0.1MIL	1/4MOA
1 Turn travel		10MIL	25MOA
Elevation Travel		40MIL	130MOA
Windage Travel		14MIL	48MOA
Focus		Side Focus/Parallax	
Distance		10m-Infinity	
Finish		Matte Black	
Illumination		Illumination	
Reticle		FML-MT	FMA-MT
		FML-TR1	FMA-TR1
		FML-3	FMA-3
Weight		950g (33.5oz)	

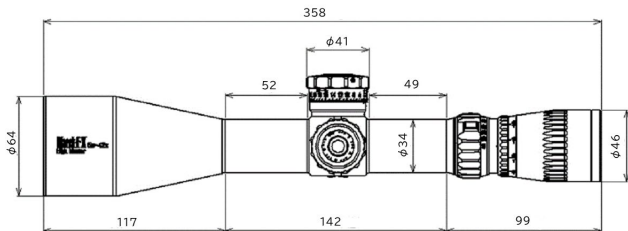

Caring for your March Rifle Scope

March Rifle Scopes are sealed units however condensation may form on the outside of the lens under extreme conditions. Should this occur, dry with a soft lens cloth immediately and allow the lens to dry completely. Doing this will prevent water spots developing on the lens surface.

March recommends that only quality lens cleaning material is used on the objective and eyepiece lenses to avoid scratching the glass.

Repair Services

Please retain and follow the Warranty paperwork in case your March Rifle Scope requires repair with the Warranty period. Please inquire of the dealer purchased from, and follow their repair request instruction. When returning your March Rifle Scope for repair, please enclose and provide a full description of the issue you are having on the form provided with your Warranty.

Should repairs be required outside Warranty period, please contact the dealer purchased from or Deon Optical Design Corporation before sending.

Memo



March®

Manufacturer

DEON

DEON Optical Design Corporation

9700-3 Miyagawa, Chino-shi,

Nagano-ken, 391-0013 Japan

E-mail: info@deon.co.jp

URL: <https://marchscopes.com>