

130	1500	1600	△ to 400 PSI	1600 Ft. Elev.	@400 PSI % Grade	Elev. △	Grd. △	Dist. △ @ 1,600'
Laterals	PSI	PSI						
7	278	291	109	251	15.7%	833	52.0%	700'@15%
6	266	279	121	280	17.5%	815	50.9%	
5	247	259	141	324	20.3%	779	48.7%	
4	233	246	154	355	22.2%	703	44.0%	
3	214	226	174	400	25.0%	620	38.7%	
2	196	209	191	440	27.5%	517	32.3%	
1	175	188	212	489	30.6%	415	25.9%	
0	157	169	243	561	35.0%	334	20.9%	

130	1500	1600	△ to 400 PSI	1600 Ft. Elev.	@400 PSI % Grade
Laterals	PSI	PSI			
7	640	652	-252	-581	-36.3%
6	620	632	-232	-535	-33.5%
5	585	598	-198	-455	-28.5%
4	538	551	-151	-348	-21.7%
3	483	495	-95	-220	-13.7%
2	421	433	-33	-77	-4.8%
1	355	368	32	74	4.6%
0	289	302	111	227	14.2%

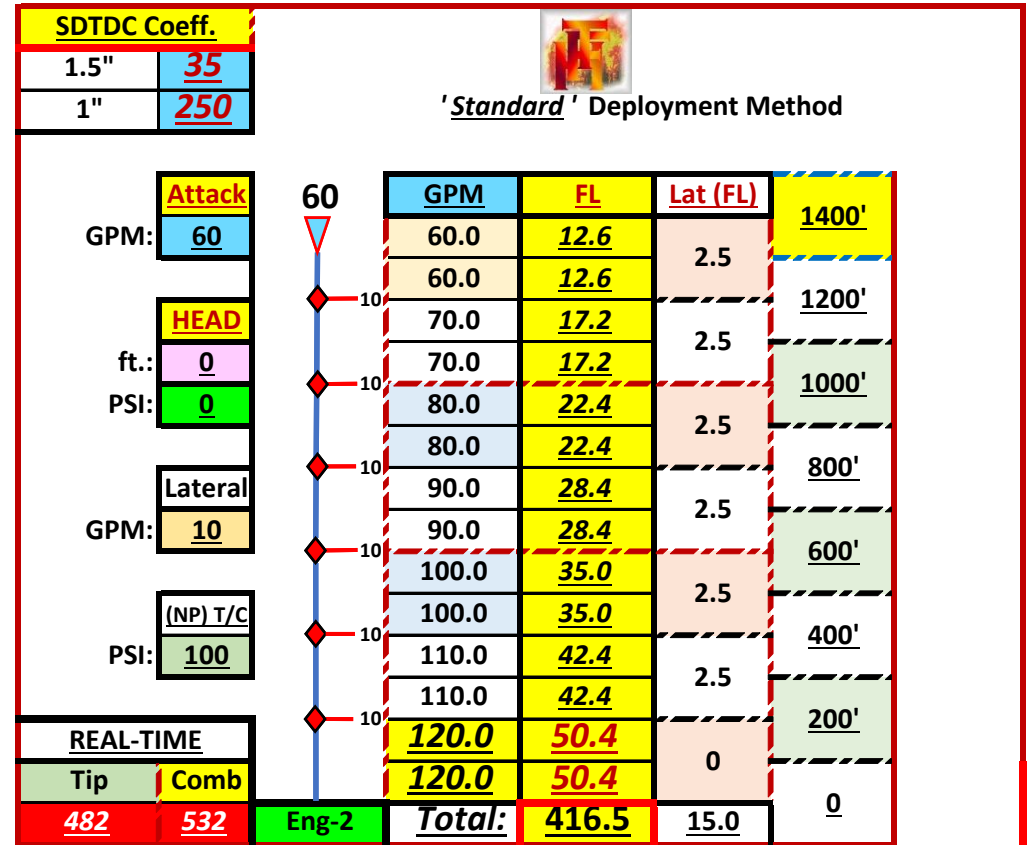
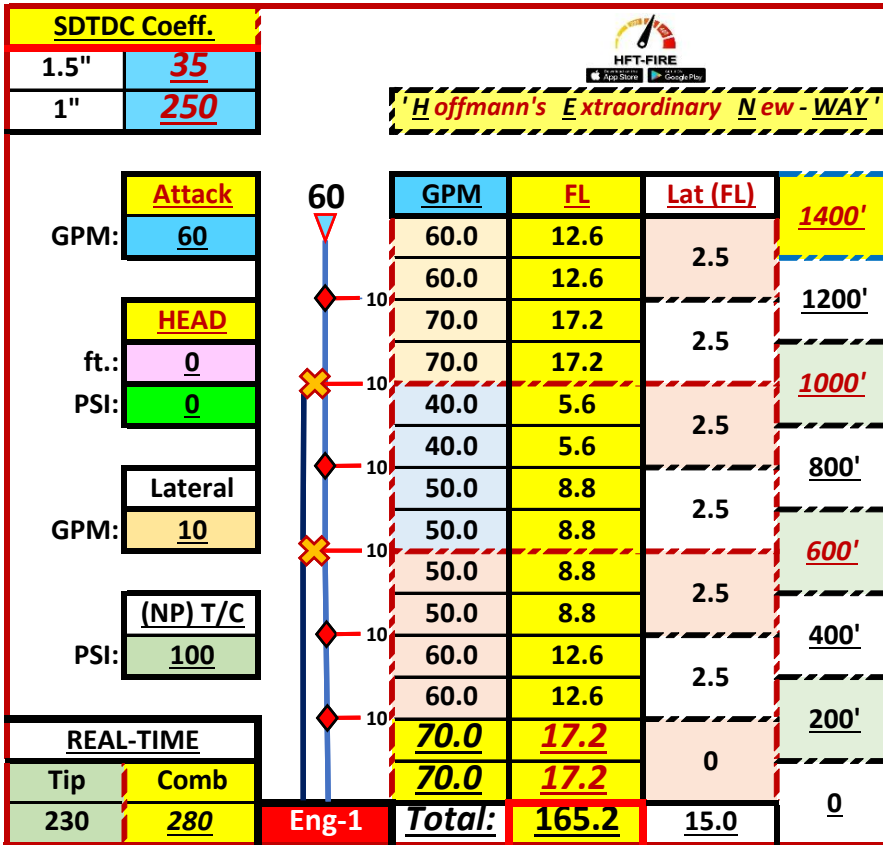

120	1300	1400	△ to	1400	@400 PSI	Dist. △		
Laterals	PSI	PSI	400 PSI	Ft. Elev.	% Grade	Elev. △	Grd. △	@ 1,400'
6	268	280	120	276	19.7%	408	41.4%	600'@19%
5	256	269	131	303	21.6%	416	40.2%	
4	238	251	149	344	24.6%	425	37.9%	
3	226	238	162	373	26.6%	411	33.0%	
2	208	221	180	414	29.5%	402	27.6%	
1	192	205	195	450	32.1%	383	21.2%	
0	169	182	218	503	35.9%	379	15.6%	

120	1300	1400	△ to	1400	@400 PSI	Dist. △		
Laterals	PSI	PSI	400 PSI	Ft. Elev.	% Grade	Elev. △	Grd. △	@ 1,400'
6	519	532	-132	-303	-21.6%			
5	500	513	-113	-260	-18.6%			
4	468	481	-81	-187	-13.3%			
3	426	439	-39	-89	-6.4%			
2	376	389	11	26	1.9%			
1	321	334	67	153	10.9%			
0	264	276	124	285	20.3%			

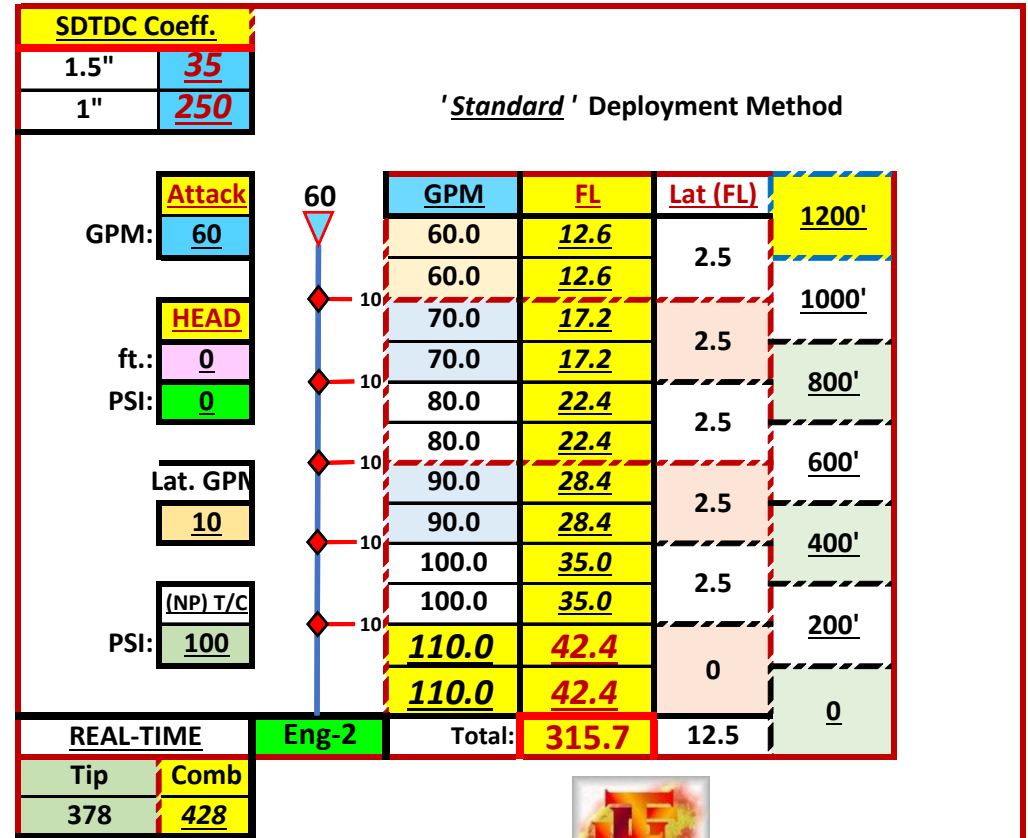
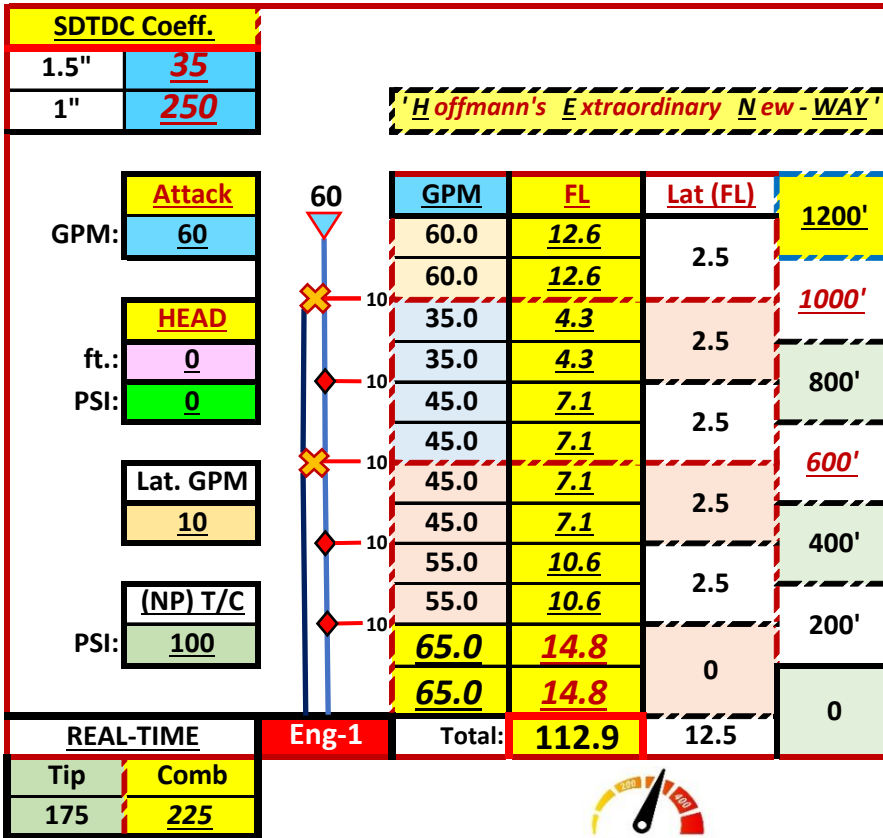

110	1100	1200	Δ to 400 PSI	<u>1200</u> @400 PSI	Dist. Δ @ 1,200'
Laterals	PSI	PSI		Ft. Elev. % Grade	
5	213	225	175	402 33.5%	467 38.9% 400' @33%
4	202	214	186	427 35.6%	453 37.7%
3	185	198	202	465 38.8%	424 35.3%
2	174	187	213	492 41.0%	362 30.2%
1	158	171	229	529 44.1%	296 24.7%
0	144	157	243	561 46.7%	218 18.1%

110	1100	1200	Δ to 400 PSI	<u>1200</u> @400 PSI	Dist. Δ @ 1,200'
Laterals	PSI	PSI		Ft. Elev. % Grade	
5	416	428	-28	-65 -5.4%	
4	398	411	-11	-25 -2.1%	
3	369	382	18	42 3.5%	
2	331	344	56	130 10.8%	
1	287	299	101	232 19.4%	
0	239	251	149	343 28.6%	

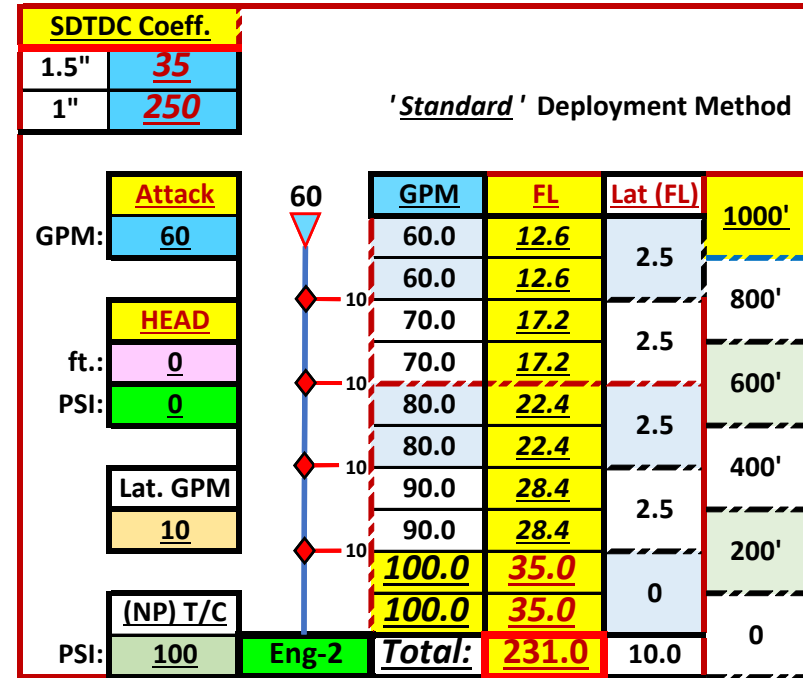
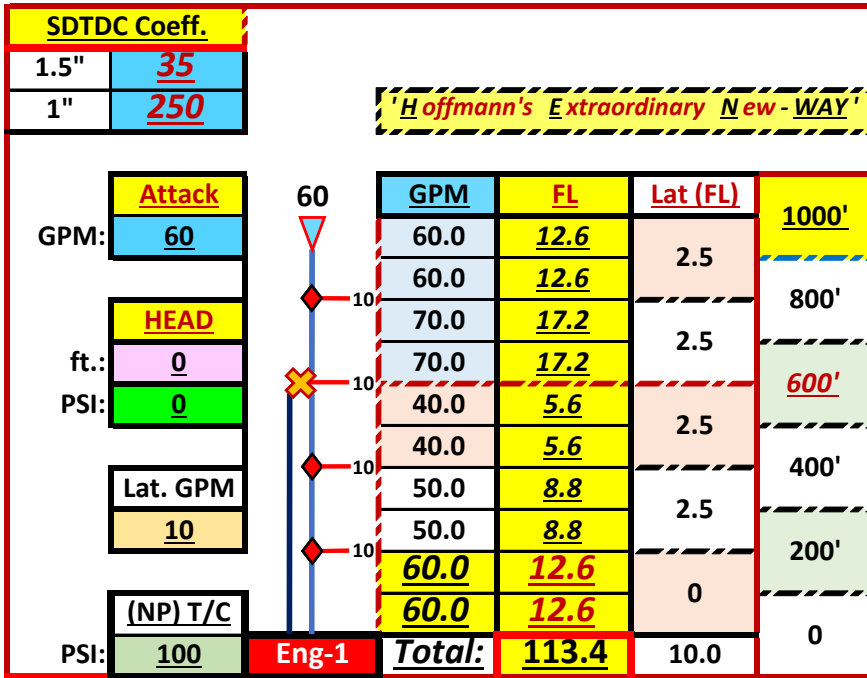

100	900	1000	△ to 400 PSI	1000 Ft. Elev.	@400 PSI % Grd.	Elev. △	Grd △	Dist. △ @ 1,000'
Laterals	PSI	PSI						
4	211	223	177	407	40.7%	271	27.1%	300'@41%
3	201	213	187	430	43.0%	258	25.8%	
2	186	198	202	465	46.5%	232	23.2%	
1	175	188	212	489	48.9%	178	17.8%	
0	157	169	231	532	53.2%	131	13.1%	

100	900	1000	△ to 400 PSI	1000 Ft. Elev.	@400 PSI % Grd.	Elev. △	Grd △	Dist. △ @ 1,000'
Laterals	PSI	PSI						
4	328	341	59	136	13.6%			
3	313	325	75	172	17.2%			
2	286	299	101	233	23.3%			
1	252	265	135	311	31.1%			
0	213	226	174	401	40.1%			

REAL-TIME

Tip	Comb
173	223



REAL-TIME

Tip	Comb
291	341

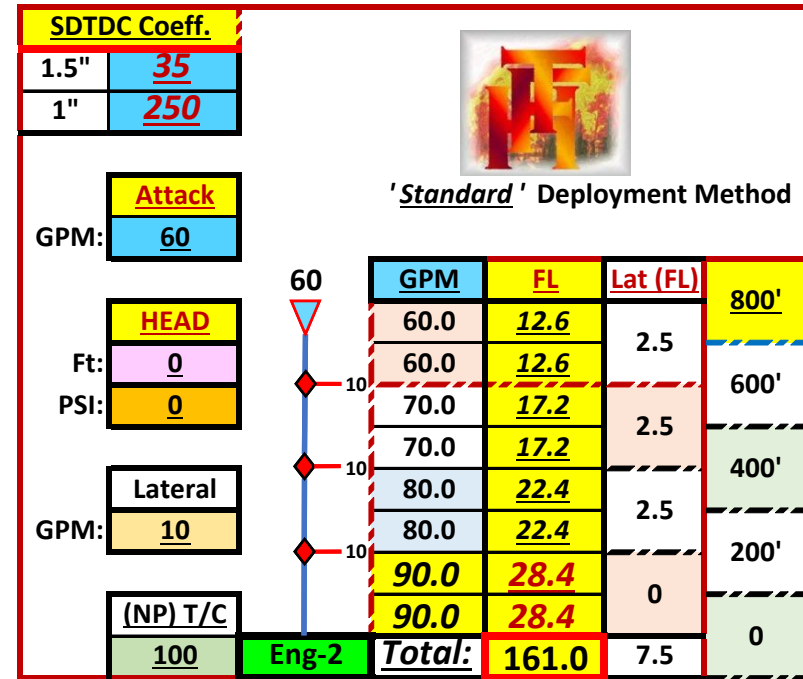
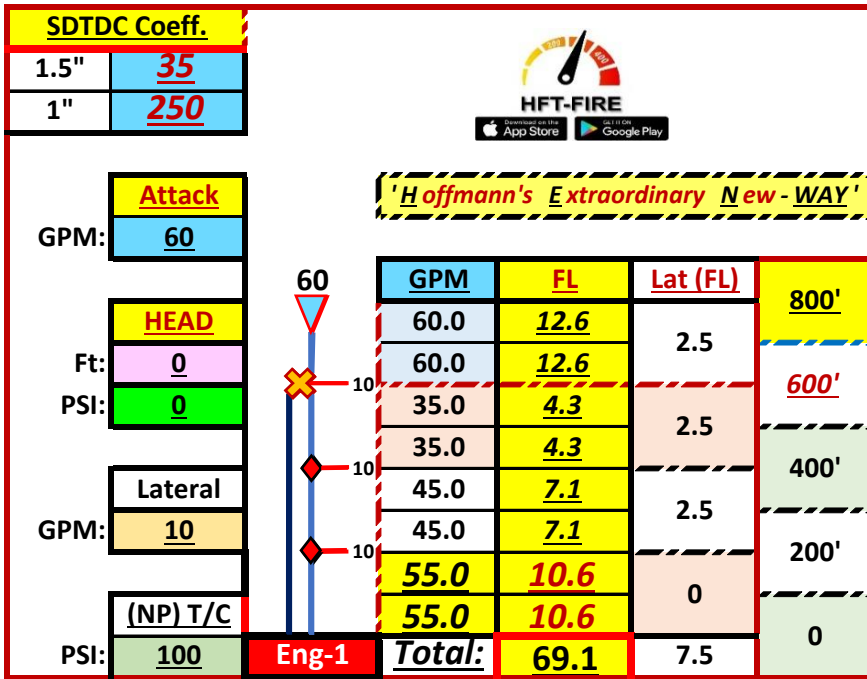

90	700	800	△ to 400 PSI	800 @400 PSI		Elev. △	Grd. △	Dist. △ @ 700'
	PSI	PSI		Ft. Elev.	% Grd.			
Laterals								
3	164	177	223	515	64.3%	212	26.5%	100'@73%
2	155	167	233	537	67.1%	200	25.1%	
1	141	153	247	568	71.0%	178	22.2%	
0	132	144	256	590	73.7%	131	16.3%	

90	700	800	△ to 400 PSI	800 @400 PSI		Elev. △	Grd. △	Dist. △ @ 700'
	PSI	PSI		Ft. Elev.	% Grd.			
Laterals								
3	256	269	132	303	37.9%			
2	242	254	146	336	42.0%			
1	218	231	169	390	48.8%			
0	188	201	199	459	57.4%			

REAL-TIME

Tip	Comb
127	177

REAL-TIME

Tip	Comb
219	269

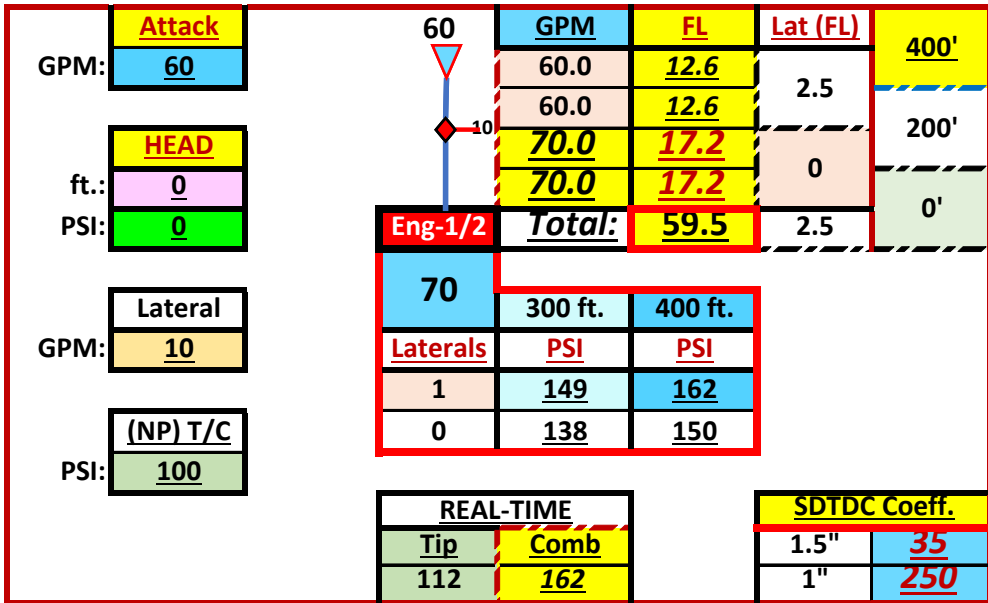
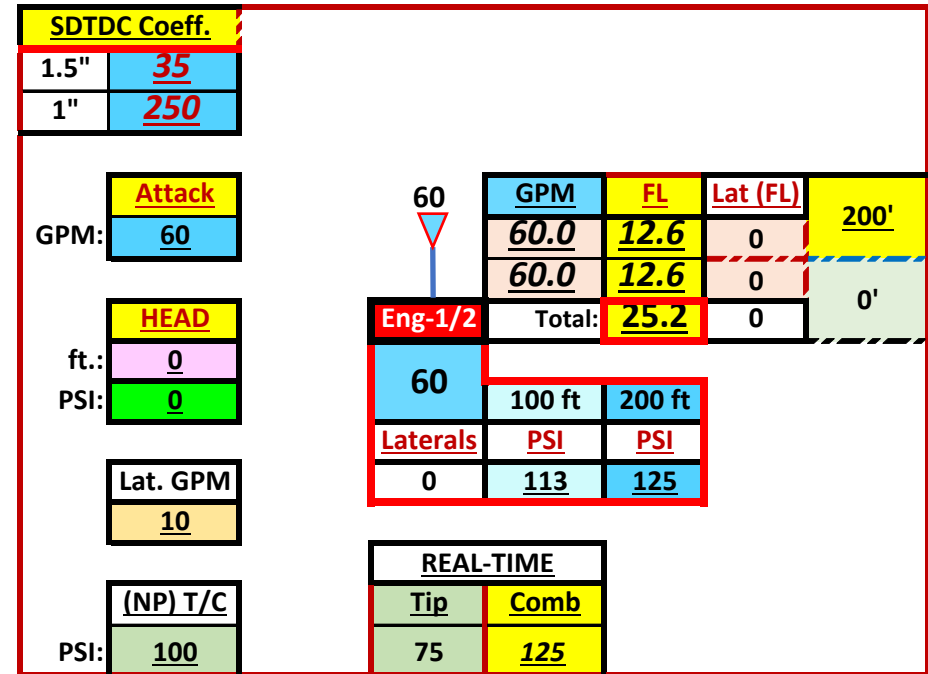
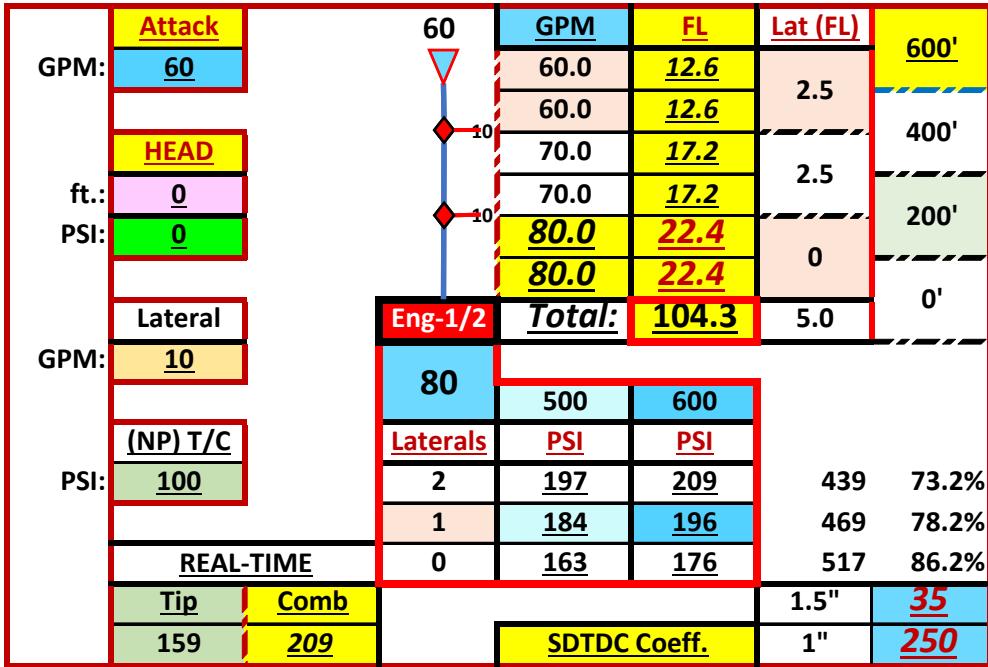

'Standard' vs.
 'Hoffmann's
 Extraordinary
 New-WAY'
 methodology



HFT Fire and Rescue Technologies and Equipment, LLC
 Copyright © 2016-2020 - ALL RIGHTS RESERVED