



Proprietary and Restricted Rights Notice

Information within this document is subject to change without notice. No part of this documentation may be reproduced in any form or by any means including photocopying, recording or microfilming or by any information storage and retrieval system including a web site, without written permission of 3D Systems.

No liability is assumed by 3D Systems with respect to the use of the information contain herein. While every precaution has been taken in the preparation of this documentation, 3D Systems assumes no responsibility for errors or omissions that may appear in this document. References in this document do not constitute an endorsement of any products or services.

© 1996-2019 3D Systems All rights reserved

Geomagic Solutions, Geomagic, the Geomagic logo, Geomagic Control, Geomagic Design X, Geomagic Design, Geomagic Essentials, Geomagic Freeform, Geomagic Freeform Plus, Geomagic Touch, Geomagic Touch X, Geomagic Phantom Premium, Geomagic Sculpt, and Geomagic Wrap are either trademarks or registered trademarks of 3D Systems.

All other company and product names referenced herein are trademarks or registered trademarks of their respective owners.

About Us

3D Systems is a leading global provider of 3D content-to-print solutions including 3D printers, print materials and on-demand custom parts services for professionals and consumers alike. The company also provides CAD modeling, reverse engineering and inspection software tools and consumer 3D printers, apps and services. Its expertly integrated solutions replace and complement traditional methods and reduce the time and cost of designing and manufacturing new products. 3D Systems' products and services are used to rapidly design, communicate, prototype or produce real functional parts, empowering customers to create and make with confidence.

More information on the company is available at www.3DSystems.com

ACTIVITY: User Interface Customizations

To locate where all system files are located, click the Directories category and view the disk paths on the option page. System paths change based on operating system version in use.



1. Change the location of the **Default Open Directory**.

- Click the **Application Button > Options**.
- Click **Frequently Used** (default).
- Locate the **Default Open Directory** option at the top of the page.
- Change the path using the **Browse** button to a directory containing data files for **Geomagic Essentials**.
- Click **OK** to exit.

Quick Access Toolbar

1. The **Quick Access Toolbar** (QAT) is located by default above the main ribbon bar at the top left edge of the application window. The QAT by default contains the **Open** (file), **Save** (file), **Undo** and **Redo** commands.
 - An expansion arrow is located at the right end of the **QAT**, see **Figure 120**. When clicked, options for the **QAT** are presented.



Figure 120

- Click on the **QAT** expansion button.
 - From the **QAT** options menu, select **Show Below the Ribbon**. The **QAT** will be positioned below the main ribbon bar.
 - Click on the **QAT** expansion button again.
 - From the **QAT** options menu, select **Show Above the Ribbon**. The **QAT** will be positioned above the main ribbon bar at its default location.
2. Any command on the ribbon can be added to the **QAT**, a maximum of 50 commands may be added to the **QAT**.
 - Click **View > Navigation > Rotation Center** down arrow on the ribbon; the menu of options for the **Rotation Center** command will appear. Instead of activating a command, **RMB** click on **Set Rotation Center** and select **Add to Quick Access Toolbar** from the options menu.

The **Set Rotation Center** icon will appear on the **QAT**.

- To remove a command from the **QAT**, **RMB** click the **Set Rotation Center** icon on the **QAT** and select **Remove From Quick Access Toolbar** on the options menu.

The process for adding and removing commands on the **QAT** are the same for every command on the ribbon bar. This enables you to have commands from different tabs and be able to invoke frequently used commands without tab switching.

End of Activity

Directories The default directory for opening and saving data files.
Workspace Defines the default settings for: - Decimal Places - Unit system - Language - Color Scheme.
Display Size Controls the default pixel size of commonly displayed primitives and geometry types in the Graphics Window .
Selection Tools Defaults settings in pixels for the Paintbrush and Line selection tools.
Invert Scroll Wheel Zoom Toggles the magnification direction of the Zoom command on the mouse scroll wheel.
Enable Spaceball This option will toggle on/off the use of a Spaceball connected to the system.

Table of Contents

Introduction	8
Overview	8
Intended Audience.....	8
Prerequisites.....	8
Guide Length	Error! Bookmark not defined.
Guide Conventions	8
Graphical User Interface.....	9
Navigation & Selection	12
Mouse Commands.....	12
Panel Window	19
Panel Tabs	19
Dialogs	22
Context Menus	23
User Interface Context Menu.....	23
Model Manager Context Menu.....	23
Graphics Window Context Menu	24
Search	24
Help	25
Help Dialog.....	25
Context Sensitive Help	25
Data Types	26
Unordered Point Data	26
Ordered Point Data	27
Polygon Data	28
NURBS Data	29
Curve Data.....	30
Scan Registration	31
Overview	31
Manual Registration (1-Point).....	31
Global Registration.....	34
Combine Point Objects (Unordered Point Data).....	34
Registering Ordered Scan Data	35
Manual Registration (n-Point).....	37
Global Registration.....	39
Combine Point Objects (Ordered Point Data)	40
Points	41
Overview	41
Disconnected Components	42
Outliers	42
Manual Editing	43
Reduce Noise.....	44

Point Sampling.....	46
Wrap.....	47
Feature Objects.....	48
Overview.....	48
Sphere Feature.....	49
Feature Properties.....	50
Cone Feature.....	51
Cylinder Feature.....	51
Plane Feature.....	53
Circle Feature.....	55
Alignment.....	56
Align to World.....	57
Create a Point of Origin.....	58
Polygon Objects.....	59
Overview.....	59
Manual Editing.....	60
Floating Triangles.....	61
Reduce Noise.....	61
Mesh Doctor.....	62
Filling Holes.....	63
Checking the Mesh.....	70
Fill Single.....	72
Sandpaper.....	72
Defeature.....	73
Mesh Maintenance.....	73
Decimate.....	74
Exact Surfaces.....	77
Overview.....	77
AutoSurface.....	78
Deviation Analysis.....	79
Exporting the NURBS Surfaces.....	79
Curves.....	80
Overview.....	80
Projected Curve Creation.....	80
Mesh Maintenance.....	80
Draw/Edit Projected Curves.....	81
Convert Projected Curves to Boundaries.....	82
Section Curves.....	83
Curve by Section (Spline).....	83
Curve by Section (Line/Arc).....	84
Appendix.....	86
Mouse Controls.....	86
Hot Keys.....	87
Options.....	87
Quick Access Toolbar.....	89
Ribbon Customization.....	89
Error! Bookmark not defined.	

Hot Keys

Listed in the table are the default **Hot Keys**. These hot keys will allow you to access certain commands quickly without selecting the command from the Menu Bar or a Tool Bar.

CTRL+N	New File
CTRL+O	Open File
CTRL+S	Save File
CTRL+Z	Undo
CTRL+Y	Redo
CTRL+T	Activate Rectangle Selection Tool
CTRL+L	Activate Lasso Selection Tool
CTRL+P	Activate Paintbrush Selection Tool
CTRL+U	Activate Custom Region Selection Tool
CTRL+W	Activate Polyline Selection Tool
CTRL+V	Toggle Select Visible / Select Through
CTRL+A	Select All
CTRL+C	Clear All
CTRL+F	Set Rotation Center
CTRL+R	Reset Current View
CTRL+B	Reset Bounding Box
F1	Activate Help
F5	Select All Objects of Same Type as Active Object
F12	Toggle On / Off Transparency
ESC	Interrupt Operation
DEL	Delete; Points, Polygons, Faces, Curves, Surfaces
CTRL+X	Application Options

Options

When first opened, the **Frequently Used** page is displayed. Other settings are for more advanced users. The **Frequently Used** options are described below:

Frequently Used

Appendix

Mouse Controls

Right-Hand Mouse is shown

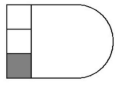
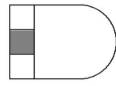
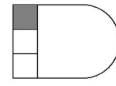
	<p>MB1</p>	<ul style="list-style-type: none"> ❖ Selection Button <ul style="list-style-type: none"> ➢ Use to change ribbons or tabbed panels ➢ Use to activate commands ➢ Use to activate objects in the Model Manager Panel ➢ Use to make selections in the Graphics Window on the active object(s) by clicking or click/drag selection tool. ❖ Move Command Plane <ul style="list-style-type: none"> ➢ CTRL+Click to click/drag a command plane when a command has the Align Plane option ❖ Model Manager Panel <ul style="list-style-type: none"> ➢ SHIFT+Click on object in the graphics area to locate it in the Model Manager ❖ Light Bulb <ul style="list-style-type: none"> ➢ ALT+Click to move Graphics Window light bulb
	<p>Scroll Wheel</p>	<ul style="list-style-type: none"> ❖ Zoom <ul style="list-style-type: none"> ➢ Zoom in or out by placing cursor at area of interest and rolling scroll wheel. Roll wheel away from you to decrease magnification, roll wheel towards you to increase magnification. ❖ Pan <ul style="list-style-type: none"> ➢ ALT+Click enables display panning in Graphics Window ❖ Feature Selection <ul style="list-style-type: none"> ➢ CTRL+Scroll cycles through the stack of feature that are within the selection zone of the cursor ❖ Dialogs <ul style="list-style-type: none"> ➢ Increases or decreases the value in a numeric field when the mouse cursor is located within a numeric input field
	<p>MB2</p> <p>MB3</p>	<ul style="list-style-type: none"> ❖ Click and drag changes 3D view of objects in the Graphics Window ❖ Pan <ul style="list-style-type: none"> ➢ ALT+Click enables display panning in Graphics Window ❖ Pop-Up Menu's <ul style="list-style-type: none"> ➢ Single click in the Graphics Window will display a pop-up menu of common commands ➢ Click on object in Model Manager Panel to display context menu ➢ Click on UI elements to display UI context menu

Right-Hand Mouse Arrangement:

- MB1= Left Mouse Button (LMB)
- MB2 = Middle Mouse Button (MMB)
- MB3 = Right Mouse Button (RMB)

Left-Hand Mouse Arrangement:

- MB1= Left Mouse Button (RMB)
- MB2 = Middle Mouse Button (MMB)
- MB3 = Right Mouse Button (LMB)

Introduction

Overview

This guide covers the fundamental commands and workflows utilizing **Geomagic Essentials** software and covers the fundamental commands, concepts and workflows.



Intended Audience

This guide is targeted to users of **Geomagic** products who require an entry level understanding of captured data processing.

Prerequisites

None

Guide Conventions

Bold Text	Indicates mouse button clicks to locate a command in the user interface in the format of Tab > Group > Command , example: View > Navigation > Fit Model to View View (Tab) > Navigation (Group) > Fit Model to View (Command) Bold text also may be used to draw attention to or create emphasis for key concepts in activity steps.
•	A dotted bullet indicates an actionable item in the training activities.
	This symbol is used to identify additional information within the context of an activity step. Text following this symbol is not actionable within an activity step.
⦿	A circled bullet is an information item found outside of an activity.
	<i>This symbol is used to strongly advise or convey important information when used.</i>

2. Click **Apply** to fit the line/arc curve through the section.

 You can view the fitting of the curve section; make fitting adjustments and **Apply** again to update the fit of the curve at any time while in the dialog.

 Using increasingly smaller values with the **Line/Arc** option active will produce more small circular arcs in your curve profile and vice versa.

- Click **OK** to exit the dialog.
- A curve object is created in the **Model Manager Panel**, Right click all other objects and Hide them to view the new **Free Curve** object, see **Figure 119**.



 Line/Arc free curve objects may be edited in the *Sketch* environment.

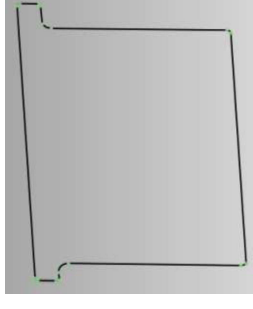

Figure 119

End of Activity

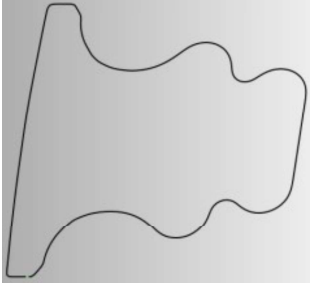

Figure 117

2. Click **Apply** to fit the spline curve through the section.

You can view the fitting of the spline; make fitting adjustments and Apply again to update the fit of the spline curve at any time while in the dialog.

- Click **OK** to exit the dialog.
- A curve object is created in the **Model Manager Panel**, Right click and choose **Hide** on the root to view the new **Free Curve** object, see **Figure 117**.



Free Curve objects may be saved as an IGES file for downstream applications.

Curve by Section (Line/Arc)



1. Make the polygon object **active** by clicking it in the **Model Manager Panel**.
 - Click **Model > Free Curves > Create by Section** on the ribbon.
 - In the **Section Type** roll-up group, verify that **Planar** is selected.
 - In the **Align Plane** roll-up group, verify that the **Define** drop-down list is set to **System Plane** and set the **Plane** drop-down list to **YZ-Plane**.
 - In the **Align Plane** roll-up group set the **Position** value to **0.0 mm**, press **Enter** to update the section plane position in the **Graphics Window**, see **Figure 118**.

The white section plane can be moved in the Graphics Window by holding the CTRL key down while click/dragging.

- In the **Curve Properties** roll-up group set **Curve Type** to **Line/Arc**, set the **Tolerance** value to **0.05 mm**.

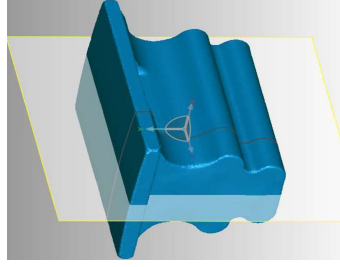

Figure 118

Graphical User Interface

Introduction to the Graphical User Interface (GUI).

ACTIVITY: Getting Started

Objective

Locate the primary components of the application user interface.



1. From the Windows Start button, select **Start > All Programs > 3D Systems > Geomagic Essentials** to start the application.



2. From the **Desktop**, double-click the **Geomagic Essentials** icon to start the application. The application will start as shown in **Figure 1**.

Clicking a Tab will change the current ribbon to display different command Tab Groups.

In the Panel Window area, the Model Manager Panel displays objects that are opened, imported or created.

The Getting Started tab above the Graphics Window provides access to the Recent Files list, Tasks and other useful Resources.

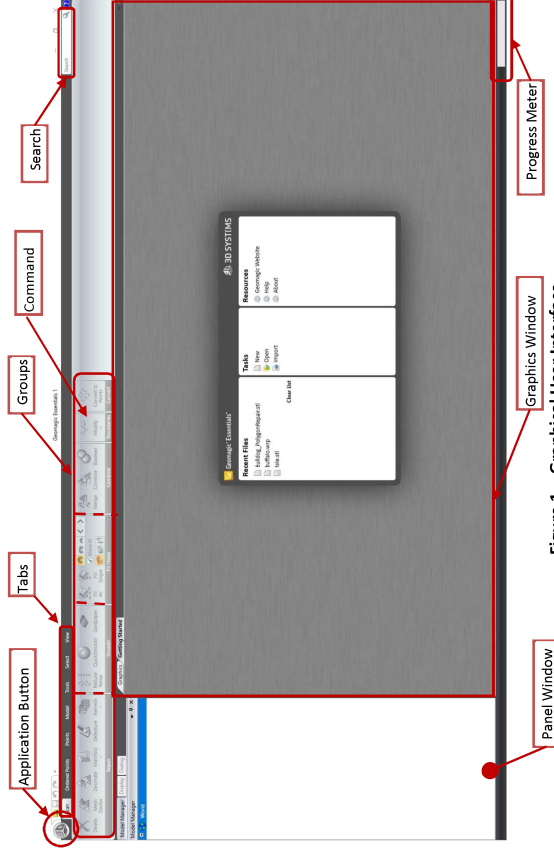

Figure 1 – Graphical User Interface

File Open



1. Click the **Getting Started** tab and select **Open** from the **Tasks** list or click the **Application Button** at the top left corner of the application and select **Open** from the menu.

- Use the **Open Files** dialog to navigate to the training files folder. Choose **TR-00.wrp** from the **Open Files** dialog.

☞ Files in *Geomagic Essentials format* have a *.WRP* extension.

- Click **Open**. The file is loaded and displayed in the **Graphics Window**, see **Figure 2**.
- ☞ When a data file is opened in *Geomagic Essentials*, the *Graphics* tab activates in the *Graphic Window*.

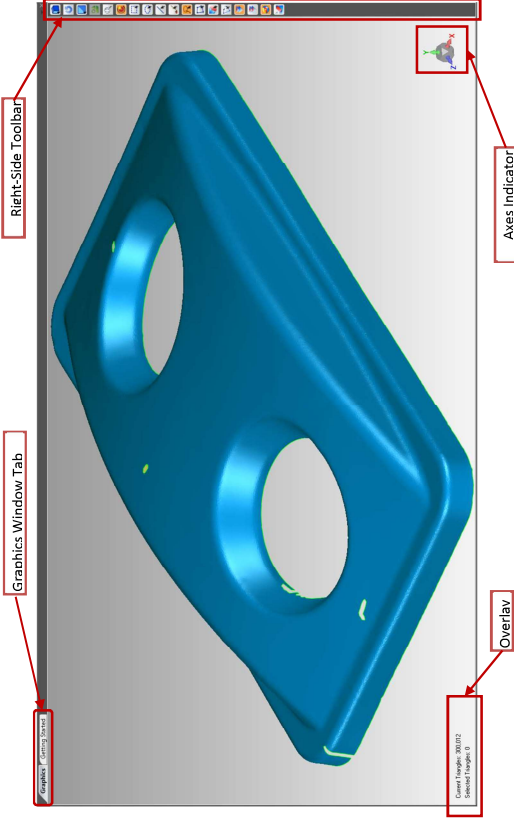

Figure 2

End of Activity

Section Curves

Free Curve object has no association with either the point or polygon model it is derived from and is an independent object in the **Model Manager Panel**. The **Create by Section** command creates a **Free Curve** object by either **Cylindrical** or **Planar** sections. **Free Curve** objects created with a cylindrical section are spline based and are not editable. **Free Curve** objects created by planar section may be either line/arc or spline based. **Line/arc Free Curve** objects are particularly useful for creating extrusion/revolve profiles in CAD systems.

Free Curve objects may be derived from projected curves by using the **Model > Projected Curves > Convert to > Free Curves** command on the **Curves** ribbon.

Line/arc planar sections are classified as **Sketch** objects in the **Model Manager Panel** and may be edited in the **Sketch** environment.

All **Free Curve** sections may be transferred to CAD/CAM/CAE applications by way of **IGES**;

ACTIVITY: Create by Section

Objective

Create a spline based curve using a planar section for downstream applications.

- Create by Section

Training File

TR-10.wrp

File Open



1. Use your choice of methods to access the **Open** command.
 - Navigate to the training files folder and **Open TR-10.wrp**.

Curve by Section (Spline)



1. Click **Model > Free Curves > Create by Section** on the ribbon.
 - In the **Section Type** roll-up group; verify that **Planar** radio button is selected.
 - In the **Align Plane** roll-up group; verify that the **Define** drop-down list is set to **System Plane** and the **Plane** drop-down list is set to **XY-Plane**.
 - In the **Align Plane** roll-up group set the **Position** value to **14.0 mm**, press **Enter** to update the section plane position in the **Graphics Window**, see **Figure 116**.
 - In the **Curve Properties** roll-up group set **Curve Type to Spline**, set the **Fitting** drop-down list to **Tolerance** and change the **Tolerance** value to **0.005 mm**.

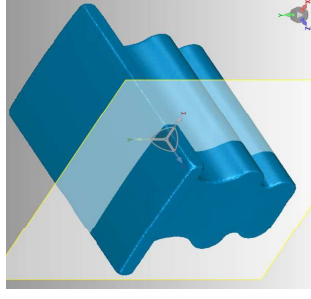

Figure 116

4. Rotate the model to the opposite side and place a checkmark in the **Curvature Map** checkbox in the **Display** roll-up group.
 - Use the **Curvature Map** and **position** the points as before on the areas of curvature as shown in **Figure 114**.
 - Turn off the curvature map by **deselecting** the **Curvature Map** option in the **Display** group of the dialog.

☞ If you make a mistake, use CTRL+Z to undo and try again.

☞ You can increase the curvature map intensity by pressing the “+” key and decrease the intensity of the curvature map by pressing the “-” key. Green indicates little or no curvature. Rounds/edges are shaded to dark blue while radii are shaded to dark red.

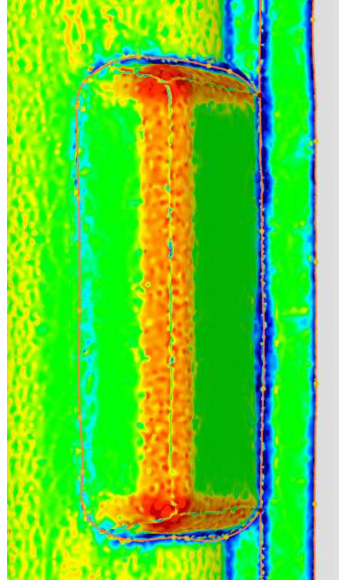

Figure 114 - Curvature Map Displayed

5. After editing and verifying that the curves are positioned correctly on the edges specified, click **OK** to exit the dialog.

Convert Projected Curves to Boundaries



1. Click **Model > Projected Curves > Convert to > Boundaries** on the ribbon.

☞ The projected curves will be converted to Boundaries, see Figure 115.

*☞ Boundaries may be deleted by **Polygons > Boundaries > Remove Boundary**.*

*☞ Boundaries will “fix” in place any triangles they touch; many commands including **Decimate** and **Mesh Doctor** will honor boundaries when operating on a mesh. Boundaries can also be used as constrained contours in surfacing.*



Figure 115

End of Activity

Right-Side Toolbar

This toolbar contains commonly used view and selection commands.

Axes Indicator (Navigation Widget)

The **Axes Indicator** displays the current orientation of the model relative to the **World CSYS**. (This is not coordinate system 0, 0, 0.) The **Axes Indicator** allows the user to control the view orientation by selecting elements of the indicator.

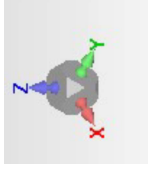

Showing World CSYS Orientation

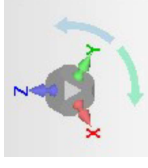

Planar Rotation - 90°

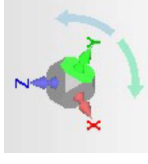

Change Orientation - Y-Axis

Overlay

Information displayed in the **Overlay** area is controlled in the **Overlay** roll-up group of the **Display** panel.



Navigation & Selection

This section uses a polygon object as an example; all commands in this section work the same for point and CAD objects except where noted.

Mouse Commands

ACTIVITY: Using the Mouse

Objective

Learn the mouse operations in the Graphics Window.

Pan and Zoom

1. Position the current view by using the **Pan** command.
 - Place your cursor in the **Graphics Window**, press the **ALT** key and hold down the **right-mouse button (RMB)**.
 - **Move** the mouse right or left to pan from one side to the other. **Move** the mouse away or towards you to pan from top to bottom.
 - Release the **right-mouse button (RMB)** to stop the pan operation.
2. Change the magnification of the object in the **Graphics Window** by using the **Zoom** command.
 - Place your cursor in the **Graphics Window** at a location of interest and use the **scroll-wheel** to zoom in by rolling the **scroll-wheel** towards you. To zoom out, roll the **scroll-wheel** away from you.

The Zoom command is sensitive to cursor position, move the cursor and zoom in/out at the area of interest.



3. Cause all objects to **Fit** within the **Graphics Window**.

- Click the **Fit Model to View** icon on the **Right-Side Toolbar**.

View Rotation

1. Place the cursor in the **Graphics Window**; press and hold the **middle-mouse button (MMB)**.
 - **Move** the mouse in the **Graphics Window** to rotate the object.
 - **Moving** the mouse inside the circle that appears in the **Graphics Window** performs a spherical (3D) rotation.
 - **Moving** the mouse outside the circle that appears in the **Graphics Window** performs a planar rotation, parallel to the current view.

Draw/Edit Projected Curves

1. **Rotate** the model and **Zoom** to the view as shown in **Figure 111**.

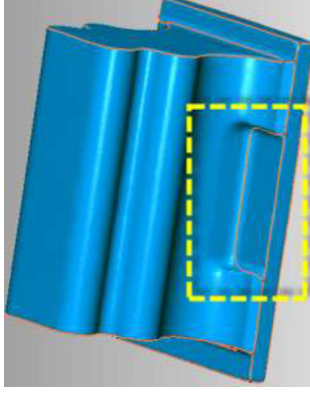

Figure 111

2. Click **Model** > **Projected Curves** > **Draw** on the ribbon.



There are several curve editing tools available, in this section we will focus on dragging the projected curves from the previous section to better align with the edges of the model.

Projected curves have red endpoints and yellow control points along their length, moving/adding or deleting a control point will affect the shape of the curve. Moving the endpoints will affect the position of the endpoint and shape of a curve near the endpoint edited.

As you cursor over an endpoint or control point a square selection box will appear indicating you can snap your cursor to that point. As you cursor over a curve segment a round selection circle will appear indicating you can snap your cursor to that curve segment.



- Verify that the **Draw** icon is active (orange highlight).

3. Hover over each of the endpoints and control points until a **selection box** appears and **click/drag** to **move** each point to the new locations as shown in **Figure 113**.

If you make a mistake, use CTRL+Z to undo and try again.

Press F1 while hovering the cursor over the Draw Curves dialog for a full description of the editing tools; in particular the About the Draw Operations. For basic details on the available Operation tools, refer to Error! Not a valid bookmark self-reference. – Curve and Contour Operations



Figure 112 - Before Curve Editing

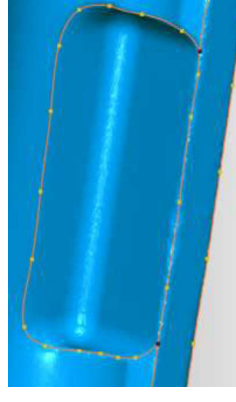

Figure 113 - After Curve Editing

Curves

Overview

Curves may be drawn directly on polygon models and converted to free curve objects for export, or to points or boundaries. Curves converted to boundaries are useful for mesh protection and surfacing.

Planar free curves may be created and can be used to describe profile geometry.

Free curves may be saved as an IGES file for import to an application that supports free curve geometry.

Projected Curve Creation

ACTIVITY: Projected Curve Creation

Objective

Learn how to extract and edit a curve object from a polygon object; commands covered in this section include:

- Mesh Doctor
- Extract
- Draw
- Convert to Boundaries

Training File

TR-09.wrp

File Open



1. Use your choice of methods to access the **Open** command.
 - Navigate to the training files folder and open **TR-09.wrp**.

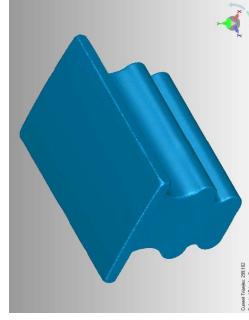

Figure 110

Mesh Maintenance



1. Click **Scan > Repair > Mesh Doctor** on the ribbon.
 - Click **Apply** if any errors in the mesh are found.
 - Click **OK** to exit the dialog.

☞ Curve extraction and editing require a "clean" mesh for best operation; it is a good practice to check the mesh prior to any operations that require the use of curves.

☞ Curves are also used in surfacing to create contours; a "clean" mesh is also required for surfacing.



2. The default center of view rotation is the bounding box center of all visible objects. To change the center of rotation:

- In the **Graphics Window**, **right-mouse button (RMB)**–click to see the **right-click menu**.
- Select **Set Rotation Center** from the **right-click menu**.
- A special cursor will appear for **Set Rotation Center**.
- **Left-mouse button (LMB)**–click a location on the object in the **Graphics Window**.
- **Rotate** the object again; notice how the object rotates about the last selected location point.

☞ If **Toggle Dynamic Rotation Center** is active in the **Right-Side Toolbar**, setting the rotation using this method will have no effect.



3. In the **Graphics Window**, **right-mouse button (RMB)**–click to see the **right-click menu**.

- Select **Reset Rotation Center** from the **right-click menu** to restore the rotation center to the center of the visible object(s) bounding box.

Viewing Tools



1. Locate the **Predefined Views** fly-out on the **Right-Side Toolbar** and click through each of the icons on the fly-out to familiarize yourself with both the fly-out behavior and changing the view orientation.

☞ *Predefined Views are orthogonal to the World Coordinate System (World CSYS).*



2. The **Reset Current View** icon when clicked will restore the last predefined view, reset the rotation center and zoom to view all visible objects.



3. Locate the **Shading** fly-out on the **Right-Side Toolbar** and click the icons to change between **Smooth Shading** and **Flat Shading**.

☞ *Smooth Shading diffuses pixels of the active object causing it to appear smoother than it is. Flat Shading reveals the object as it actually is.*



4. The **Toggle All Features** icon toggles on/off the visibility of all **Features** in the **Graphics Window**. **Left-mouse button (LMB)**–click the icon several times to view/hide the **Feature** object. *If there are no available Features, the icon will be grayed out.*

☞ *Features are Geomagic Essentials objects that have many uses.*



5. **Fit Model to View** will cause all objects to **Fit** within the **Graphics Window**.

☞ *Fit Model to View will zoom to the extents of all visible objects.*



6. **Toggle Dynamic Rotation Center** will place the center of rotation at the cursor location each time the **left-mouse button (LMB)** is clicked on the active object.

☞ *This command is activated by clicking the icon and remains on until it is clicked again. When active, the background color of the icon is orange.*

Selection Tools

1. Click the **Select Visible** icon from the **Right-Side Toolbar**.

Causes the selection tools to operate only on visible data in the current view, obscured data will not be selected.

2. Click the **Rectangle Selection Tool** icon.
Place the cursor on the object, click and hold the **left-mouse button (LMB)**.
Drag your cursor to define the second corner of selection zone. As you move the cursor, a rectangle is visible in the area to be selected.
3. **Release the left-mouse button (LMB)**. The polygons in the selection zone turn **red**, indicating that they are selected for some type of operation.
4. Hold down the **CTRL** key while selecting in the same area from the previous step (red).
Holding CTRL when using any selection tool will cause any area selected to be deselected.
5. Create more selections using the **Rectangle Selection Tool** icon.
6. Delete selected areas by pressing the **DEL** key or clicking **Scan > Repair > Delete** on the ribbon.
7. Press **CTRL+Z** to undo the last command.
8. Select and delete additional areas using the **Circle Selection Tool**, **Line Selection Tool**, **Paint Brush Selection Tool**, and **Lasso Selection Tool**.
9. Select the tools from the **Right-Side Toolbar** and make selections on the object in the **Graphics Window**.
10. Press the **DEL** key to delete selected areas.

The Line Selection Tool is active only on polygon objects.

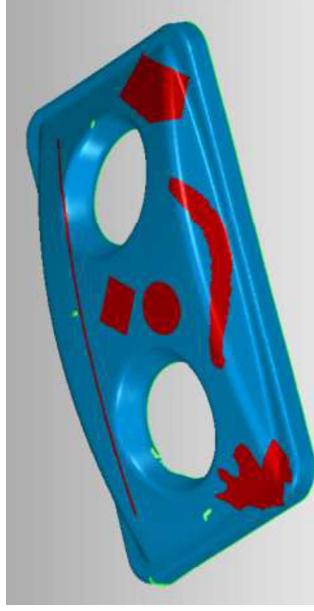

Figure 3 - Example of selected areas

Deviation Analysis

1. To perform a deviation analysis of a fitted surface, click **Tools > Compare > Deviation** on the ribbon.
 - In the **Spectrum** roll-up group, set the values for **Max/Min Critical** to **0.1/-0.1 mm** and the values for **Max/Min Nominal** to **0.05/-0.05**.
 - Click **Apply** to generate a deviation spectrum analysis, see **Figure 109**

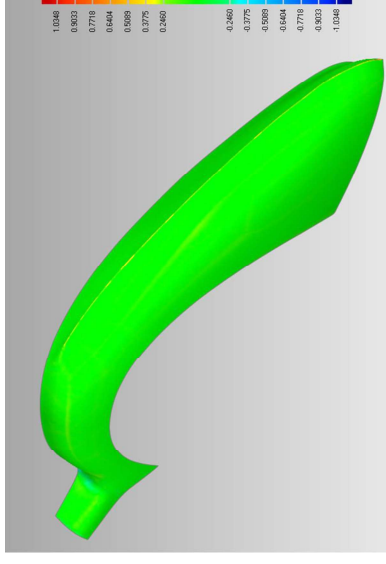

Figure 109

2. Observe the deviation map and spectrum, note that the **Constant** fitted surface is has less deviation than the **Adaptive** fitted surface from the surface fitting section of this activity.
 - Click **OK** to exit the dialog.

Exporting the NURBS Surfaces

1. Once you have applied a NURBS surface to the model, you can export this surface data to your CAE system. **Right-click** on the surfaced object in the **Model Manager Panel**.
 - Select **Save...** from the **right-click menu**.
2. Navigate to the **Desktop** in the **Save As** dialog.
 - Enter a new **File name: cad-data**
 - Select **IGES File (*.igs; *.iges)** from the **Save as type** drop-down list.
 - Click **Save**.
 - Click **Ok** when the **Export Options** dialog appears. The **IGES** file will be written to the desktop and ready for import into another CAE application.

End of Activity

AutoSurface

-  Click **Model > AutoSurface > Start AutoSurface** on the ribbon.
 - The **Entering Exact Surfaces** dialog will appear with the option to **Create New Patch Layout** selected.
 - Click **OK** to continue to **Exact Surfacing**.

After Exact Surfacing initializes, the Model Manager Panel icon for the object to be surfaced will change to an hour glass shape, indicating that it is now an Exact Surface object.
-  Click **Model > AutoSurface > AutoSurface** on the ribbon.
 - In the **Geometry Type** roll-up group, select the **Mechanical** radio button.
 - In the **Patch Count** roll-up group, select the **AutoEstimate** radio button.
 - In the **Surface Detail** roll-up group, place the slider control at **2**.
 - In the **Surface Fitting** roll-up group, select **Constant** and remove the checkmark from the **Merge patches automatically** checkbox.
- In the **Options** roll-up group, set the checkboxes as follows: **Sharpen all constrained contours = On, Extend contour lines = Off, Interactive mode = Off**.

- Click **Apply** to begin the surfacing process.

After a few moments, the object in the display will update to an Olive color, the object now has a NURBS surface applied to it, see Figure 108.

- Click **OK** to exit the dialog.

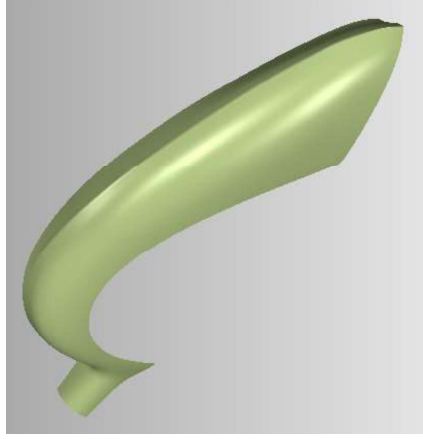

Figure 108 – NURBS Surfaces

End of Activity

- Press **CTRL+Z** to recover (undo) the most recently deleted areas of the object.

There is one level of undo in the application.

- Press **CTRL+C** to clear all selections.



- Click the **Select Through** icon on the **Right-Side Toolbar** and select an area on the object using the **Rectangle Selection Tool**.
 - Rotate the object around to view the other side of your selection. Notice that **Select Through** causes the current selection tool to affect all areas within the selection boundary, not just those visible on screen, see **Figure 4** and **Figure 5**.
 - Press **CTRL+C** to clear all selected areas.

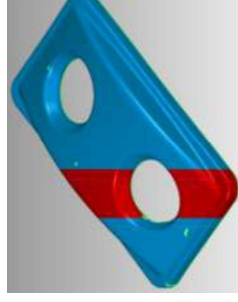

Figure 4 - Initial Selection

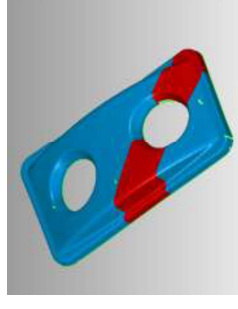

Figure 5 - Result of Selection



- Click the **Select Visible** icon on the **Right-Side Toolbar** to toggle off **Select Through** mode.

- Press **CTRL+C** to clear all selections.

- Rotate the object as shown in **Figure 6**.

A polygon object has a scan side that is blue in color (normal) and a back face side that is yellow in color.

The **Select Backfaces Mode** is **On** by default. Turning it **Off** disables direct selection of back faces (yellow side).



Figure 6

12. Make the selection with your cursor as shown in **Figure 7**.

☞ Notice that both the normal side and the back face side may be selected.

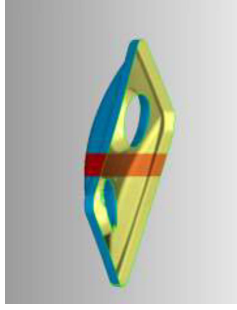

Figure 7 – Select Backfaces Mode: ON

13. Press **CTRL+C** to clear all selections.

14. Click the **Select Backfaces Mode** icon on the **Right-Side Toolbar** to turn it **Off**.

☞ When turned Off, selection tools cannot directly select back faces.

15. Make the selection again as shown in **Figure 8**.

☞ Notice that no back faces (yellow) were selected in the area specified.

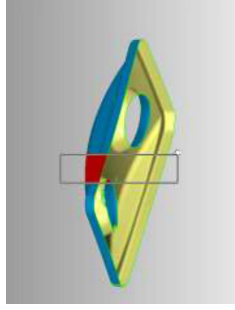

Figure 8 – Select Backfaces Mode: OFF

16. Press **CTRL+C** to clear all selections.

17. Select **Isometric View** from the **Predefined Views** fly-out on the **Right-Side Toolbar** to rotate the object into an isometric view as shown in **Figure 9**.

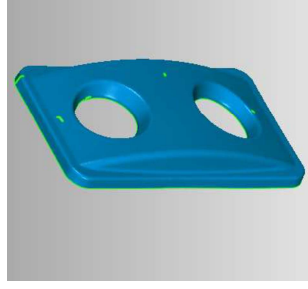

Figure 9

18. From the **Right-Side Toolbar**, click the **Polyline Selection Tool** icon.

☞ The Polyline Selection Tool will create a selection defined by clicking locations to define a boundary.



Exact Surfaces

Overview

An **Exact Surface** is a collection of smaller bounded quadrangular patches. A polygon object intended for **Exact Surfacing** can be an open or a closed volume object. Quadrilateral patches are arranged in a layout appropriate to represent the shape. A multiple resolution grid structure is laid on each patch, and a **NURBS surface** is fit to each patch. Automatic UV parameterization with global connectivity and G1 continuity is guaranteed across adjacent patches. Tangent continuity is achieved across all patch boundaries and corners unless specified otherwise by the user. The **NURBS surface** can be exported as an **IGES** or **STEP** file, and imported into any CAD/CAM or visualization system.

Good Patch Structure

Most important in producing a satisfactory **NURBS surface** object is obtaining a good patch structure. The ideal structure is:

- **Regular:** Each patch is approximately rectangular with vertices of degree four.
- **Shape appropriate:** There are no severe or multiple curvature changes (bumps or holes) in the interior of a patch.
- **Efficient:** The model contains close to the minimal number of patches consistent with the first two requirements.

ACTIVITY: AutoSurface

Objective

Learn how to use **AutoSurface** and discover the components that make up the **NURBS** control network.

Training File

TR-08.wrp

Open Data



1. Use your choice of methods to access the **Open** command.
 - Navigate to the training files folder and open **TR-08.wrp**, see **Figure 107**.

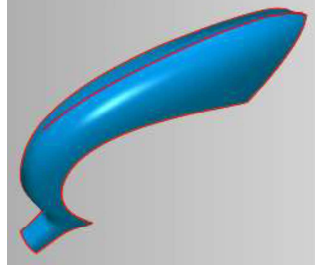

Figure 107

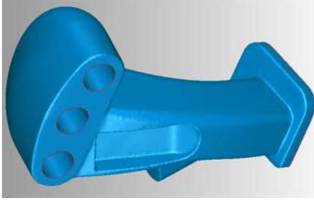

Figure 106

8. Click the **Display Panel** tab.
 - Locate the **Geometry Display** roll-up group.
 - Remove the checkmark in the checkbox next to **Edges**. The display of triangle edges will be turned off, see **Figure 106**.
 - Click the **Dialog Panel** tab to return to the **Decimate** command.
 - Click **OK** to exit the dialog.

Decimation decreases the computation time of surfacing and should be done (if necessary) as a final step prior to surfacing a part.

Large triangles make hole filling, extrusions, etc. difficult to work with. If a part is already highly decimated in areas that need these types of repairs, the **Refine** command performs the opposite effect on the mesh, subdividing triangles.

End of Activity

19. Click a set of points as shown in **Figure 10**. As you click, a boundary line will appear from click to click.
 - To define the last point in your **Polyline Selection**, move your cursor to the last location and press the **right-mouse button (RMB)** to end the process and make your selection.
 - **Rotate** the object slightly to review the selected data.
 - Press **CTRL+C** to clear the selection.



Figure 10



20. Click the **Custom Region Selection Tool** icon on the **Right-Side Toolbar**.

☞ The Custom Region Selection Tool will find both visible and non-visible areas within the bounded area you create. If the Custom Region Selection Tool is accidentally started it can be stopped by pressing the ESC key.

21. Click a set of points as shown in **Figure 11**. As you click around the region, a white boundary line will appear from click to click.
 - When you get close to your starting point, press the **right-mouse button (RMB)** to close the selected boundary.

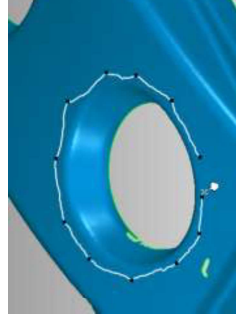

Figure 11



Figure 12

22. When the boundary is closed, it should appear as shown in **Figure 12** with the interior area selected (red).

☞ Data inside the boundary not visible to you in the current view, such as undercuts or back-draft conditions will also be selected.

23. Press **CTRL+C** to clear the selection.
 - **Rotate** the object slightly to see data not visible in the current view is selected.



24. Select adjacent triangles that meet at a specified angle of less than 3 degrees.

- Click the **Paint Brush Selection Tool** icon on the **Right-Side Toolbar**.
- Click the **Select by Angle Mode** icon on the **Right-Side Toolbar**, and select the flat area as shown in **Figure 13**.

☞ *Adjacent triangles in the polygon mesh that are within a 3 degree angle (default) of each other will be selected as shown in Figure 14.*

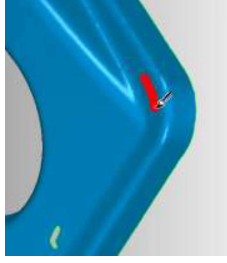

Figure 13

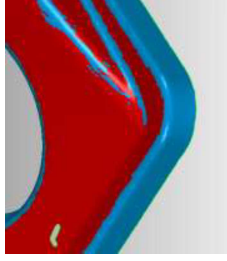

Figure 14

25. Press **CTRL+C** to clear the selection.

26. Adjust selection **Crease Angle**.

- Press **CTRL+X** to open the **Options** dialog.
- Locate the **Display** category on the dialog and click **Select**.
- On the **Selection** page; locate **Crease Angle** in the **Select by Crease Angle** group and change the value to **1.5**.
- Click **OK** to dismiss the **Options** dialog.

27. Make the same selection as before with **Select by Angle Mode** still active.

- The selected area should appear as shown in **Figure 15**.
- Click the **Select by Angle Mode** icon again to turn it **Off**.

☞ *This type of selection mode has many uses, including finding areas that are flat for other commands. The smoothness of a polygon object affects how this selection mode works.*

☞ *This tool is only active on polygon objects.*

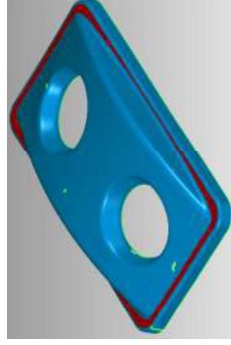

Figure 15

➔ **The majority of commands in the application operate using the following selection syntax:**

- If nothing is selected when a command is activated; the command will affect the entire active object or all active objects.
- If a selection is present when a command is activated; the command will affect the selected area only.

End of Activity

5. Click the **Reset** button at the bottom of the dialog.

- Enter a value of **40.0** in the **Reduce to Percentage** parameter field.
- Place a checkmark in the **Curvature Priority** checkbox in the **Advanced** roll-up group.
- Set the slider control for **Curvature Priority** to **3**.
- Click **Apply**, the mesh will redraw similar to **Figure 103**.

☞ *Notice a higher triangle density in the areas of high curvature.*

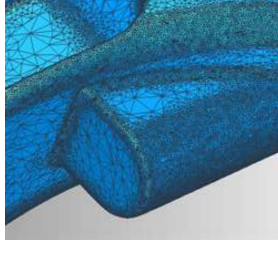

Figure 103

6. Click the **Reset** button at the bottom of the dialog.

- Enter a value of **40.0** in the **Reduce to Percentage** parameter field.
- Place a checkmark in the **Mesh Priority** checkbox in the **Advanced** roll-up group.
- Set the slider control for **Mesh Priority** to **3**.
- Click **Apply**, the mesh will redraw similar to **Figure 104**.



Figure 104

7. Change the **Reduce to Percentage** value to **30.0**.

- Click **Apply**. Note the triangle count in the **Overlay**.
- From the **Right-Side Toolbar** click **Fit Model to View**.
- Rotate model as shown in **Figure 105**, observe the reorganization of the mesh.



➔ **Take care not to over-decimate, areas of high curvature can become faceted and distort the captured information.**

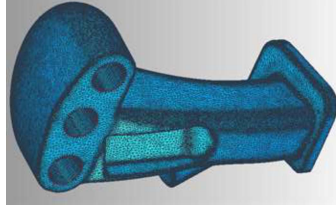

Figure 105

Decimate



1. Click **Scan > Repair > Decimate** on the ribbon.

Meshes that have undergone extensive repairs or are very dense can benefit from decimation. Decimation is the process of triangle reduction, when performed, it also reorganizes the mesh.

Decimation can also aid with smoothing an object in areas of low curvature.

2. To view the effect of **Decimate** on the mesh.
 - Click the **Display Panel** tab.
 - Locate the **Geometry Display** roll-up group.
 - Place a checkmark in the **Edges** checkbox.
 - **Zoom** to an area that contains high and low curvature similar to **Figure 101**.
 - Click the **Dialog Panel** tab to return to the **Decimate** command.

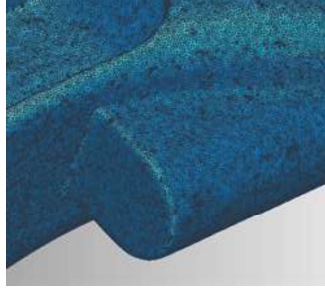

Figure 101

3. In the **Reduce to Percentage** parameter field, enter a value of **40.0** and press **Enter**; the **Target Triangle Count** will update.

A percentage or triangle count can be specified for the amount of decimation.

- Place a checkmark in the **Fix Boundaries** checkbox to protect triangle structure where boundaries are located.
- At this time the **Curvature Priority**, **Mesh Priority** and **Maximum Aspect Ratio** checkboxes in the **Advanced** roll-up group should be cleared (off).

4. Click the **Apply** button, after a few moments the mesh will redraw and appear similar to **Figure 102**.

- Note the reduction of triangles in the **Overlay**.

A specific area may be decimated by pre-selection before performing entering this command.

Some curvature protection is always present, especially on an object with areas of high curvature such as this one. On meshes that have little or no areas of high curvature, a uniform mesh will result.

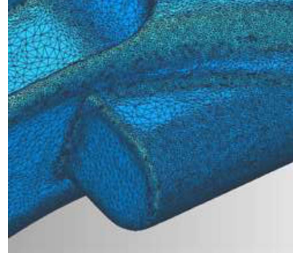

Figure 102

Panel Window

Panel Tabs

ACTIVITY: Exploring the Panels



Objective

Explore the tabs of the **Panel Window**.

- If you accidentally hide a panel and want to make it visible again, click **View > Panels > Panel Visibility and select the hidden panel from the list that appears, to make it visible**.

Training File

TR-00.wrp

1. Click the **File Open** icon on the **Quick Access Toolbar**.
 - Use the **Open Files** dialog to navigate to the folder where the training files reside. Choose **TR-00.wrp** from the **Open Files** dialog.
 - Click the **Open** button.
2. The **Model Manager Panel** tab contains objects either created or loaded into the current session. A **right-click menu** is available on objects in the tree, the commands available from the **right-click menu** change depending on the type of object selected.
3. Objects with a "+" sign next to them are nested in a collapsed branch of the tree. Clicking the "+" sign will expand the tree to reveal any nested objects.
 - Items on the tree may be renamed, deleted, hidden, saved out exclusively of other objects, or made into groups.
4. The **Display Panel** tab contains the following **roll-up groups** of display options; **General**, **Geometry Display**, **Lighting** and **Overlay**.
 - A roll-up group can be expanded or collapsed by clicking the title bar containing the roll-up group name.
5. The **General** roll-up group contains visibility options.
 - Clicking in a checkbox will toggle an option on/off.
 - Place/remove a checkmark in each of the **World CSYS**, **Axes Indicator**, and **Bounding Box** checkboxes to toggle visibility of each item in the **Graphics Window**.

You may have to zoom out to see the location of the World CSYS which is positioned at 0,0,0 of the World Coordinate System.

- Place a checkmark in the **Transparency** checkbox and move its **slider control** to change the opacity/transparency of the active object in the **Graphics Window**.
- Remove the checkmark from the **Transparency** checkbox.



6. Set the view to **Top View**.
 - Click **Top View** icon on the **Right-Side Toolbar**.

If you don't like the appearance, you can click Reset while in the command to restore the object back to its original state.



7. Clip the displayed object to view inside of it.
 - Click the **View Clipping** checkbox in the **General** roll-up group.
 - Select the **Isometric View** icon in the **Right-Side Toolbar**, see **Figure 16**.



Figure 16 – Clipped View

8. Adjust the **slider control** to change the value of **View Clipping** plane. Parts of the object are clipped (hidden from view).
 - Click the **Show Clipping Plane** checkbox to see the **View Clipping** plane, see **Figure 17**.

This command is useful for working from the inside of closed objects.

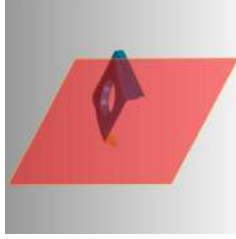

Figure 17 – Clipping Plane Visible

9. Change the orientation of the view clipping plane.
 - Remove the **checkboxmark** from the **View Clipping** checkbox.
 - **Rotate** the object in the **Graphics Window**.
 - Place a **checkboxmark** in the **View Clipping** checkbox.

Notice how the view is clipped parallel to the screen.

10. Adjust the **slider control** to see the results.
11. Remove the **checkboxmark** from the **View Clipping** checkbox.
12. The **Points Display Size** and **Edge Display Size** options control the size of points in a point cloud object and the mesh edge size in a polygon object.

13. The **Static Display Percentage** and **Dynamic Display Percentage** options limit the amount of data visible when at rest (static) or when moved (dynamic) with rotate, zoom, or pan.

This will increase display rendering speed, which is useful when working with large scan data files.

5. Click **OK** to exit the dialog.

If you don't like the appearance, you can click Reset while in the command to restore the object back to its original state.

Defeature



1. **Zoom** in on the side of the joystick embossed with the words "Made in USA". From the **Right-Side Toolbar**, click the **Custom Region Selection Tool**.
 - Click a series of points around the words, as shown in **Figure 99**. A white line will appear through the points you pick. To close the loop, either press the **spacebar**, or click the **RMB**. Once the loop is closed, all connecting triangles in the area will be selected.

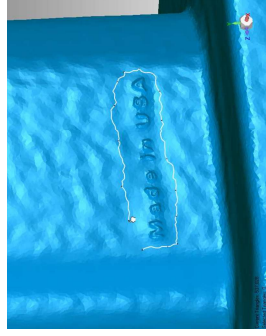

Figure 99 - Before

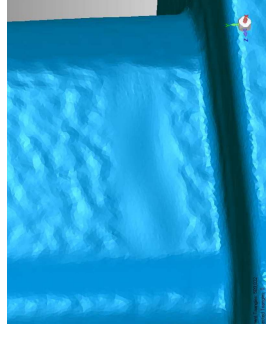

Figure 100 - After



2. With the area selected, click **Scan > Repair > Defeature** on the ribbon. The selected area is removed, as shown in **Figure 100**. The **Defeature** command is useful for removing unwanted features of the model.

Defeature deletes the selected area and performs a curvature-based hole fill.

Mesh Maintenance

1. At this stage in the activity, the polygon object should be 'watertight'.
 - Click **Tools > Measure > Compute > Compute Volume** to check the volume of the active object. If you get a value of **zero**, there is a hole somewhere in the mesh; otherwise, this object is a completely closed volume.
 - **A closed volume object is required for rapid prototype printing or SLA processing.**
2. If the object is not closed, locate the hole(s) and fill them.
3. Click **Scan > Repair > Mesh Doctor** on the ribbon.
 - Click **Apply** if any errors in the mesh are found.
 - Click **OK** to exit the dialog.

After all repairs that affect or change the mesh are completed, it is a good practice to check the mesh for any errors that may exist.

The constrained boundaries left by the Extrude Boundary and Trim with Plane commands will hold the edges they are on to prevent spike removal from rounding them off.

Fill Single

1. **Rotate** the object and locate the hole shown in **Figure 97**.
 - Click **Scan > Fill Holes > Fill Single** on the ribbon.
 - Select **Curvature** as the fill technique and **Complete** as the fill mode.
 - **Cursor** to the hole, when it highlights in **red**, **click the edge** to fill it.
 - Click the **Fill Single** button again to exit the **Fill Single** method.

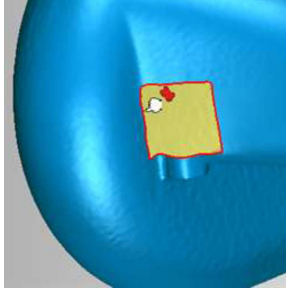

Figure 97

2. Press **CTRL+D** to fit the view.

Sandpaper

1. Click **Scan > Smooth > Sandpaper** on the ribbon.
2. Under the **Operation** roll-up group select the **QuickSmooth** radio button. Adjust the **Strength** slider to **0** (Min.)
3. Place your cursor over one of the rough areas shown in **Figure 98**, press and hold the **LMB**. A circular cursor will appear, indicating smoothing is active. Move the cursor back and forth over the areas as if you were rubbing your thumb over a clay model. Smooth as necessary.

The cursor changes in size based on the underlying mesh density.

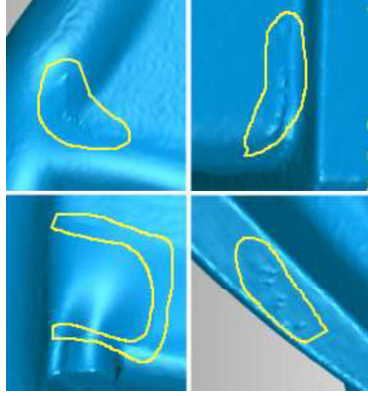

Figure 98

4. Try to find other small areas of the object that could use some smoothing, experiment with the **Relax** parameter and the **Strength** slider. Move to the next step when you are done.

13. The **Lighting** roll-up group provides options to change lighting themes from one to four lights and has slider controls. Experiment with the **Lighting** controls and themes to find one that best suits your taste.

You can use the Reset button to return all options to their defaults.

14. The **Overlay** roll-up group controls the visibility of information that shows up in the **lower left corner** of the **Graphics Window**.

- Place a checkmark in the **Model Information**, **Bounding Box Dimensions** and **Memory Usage** checkboxes. Note the information that displays into the **Overlay** section of the **Graphics Window**.

Model Information displays the total number of elements (points, polygons, etc.) of the active object, plus the number of currently selected elements.

- **It is recommended that the Model Information option be left active. The information provided is helpful when editing objects.**

15. The **Dialog Panel** tab automatically displays dialog based commands when they are activated. If no command is active, then this **Panel** is empty.

When a command is active in the Dialog Panel tab and focus has been shifted to another Panel tab in the Panel Window; you will not be able to access other commands. Return to the Dialog Panel tab and complete the currently active command to continue.

End of Activity

Dialogs

Geomagic Essentials dialogs have several controls in common with each other; this section describes the most commonly used controls and conventions. The majority of Geomagic Essentials commands are dialog based.



OK button; accepts any changes made while in the dialog and exits the dialog.



Cancel button; discards any changes made while in the dialog and exits the dialog.



Apply button; updates the command to any changes made while in the dialog – this is useful to preview parameter/option changes while making adjustments, without committing to the current settings.

If an Apply button is present in a dialog, you must press it to activate the command.



Next button; Analogous to OK and restarting the command.



Reset button; resets dialog parameters to defaults; equivalent to restarting command.



Slider Control; when scrolled to the right, increases parameter affected.

Roll-Up Groups; when rolled up, an arrow in the group title points downward, see Figure 18. Clicking anywhere on a rolled up group title will expand the group and reveal additional dialog elements, values, inputs or activate extended commands, see Figure 19.



Figure 18

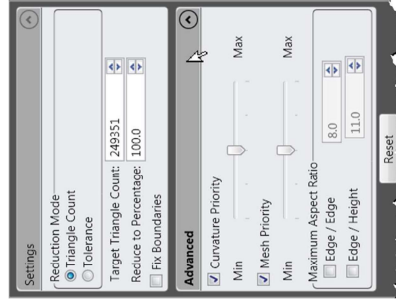

Figure 19

ACTIVITY: Level II

Objective

Apply additional repair/smoothing, trimming, boundary editing, decimation and deviation analysis commands.

Commands covered in this section include the following:

- Fill Single
- Defeature
- Sandpaper
- Relax
- Modify > Create/Fit Hole
- Move > Extrude Boundary
- Move > Project Boundary to Plane
- Trim > Trim with Plane
- Decimate

Training File

TR-07.wrp

File Open



1. Navigate to the training files folder and open **TR-07.wrp**.



- Zoom and Rotate the view to look at different portions of the polygon object in greater detail.



- Select **Isometric View** from the **Predefined View** fly-out on the **Right-Side Toolbar**.



- Select **Fit Model to View** on the **Right-Side Toolbar**, see **Figure 96**.

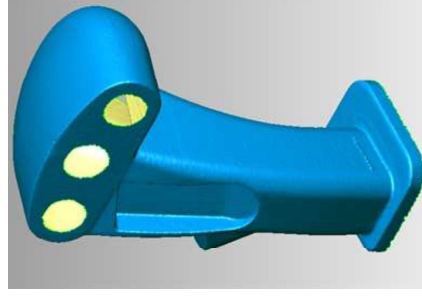

Figure 96

Checking the Mesh

1. Click **Scan > Repair > Mesh Doctor** on the ribbon.
 - Click **Apply** to resolve any errors found.
 - Click **OK** to exit the dialog.

After repair operations that affect the mesh like hole filling, it is a good practice to run the Mesh Doctor to check the mesh.

2. **Zoom, Pan** and **Rotate** the fairing, it should look similar to **Figure 95**.

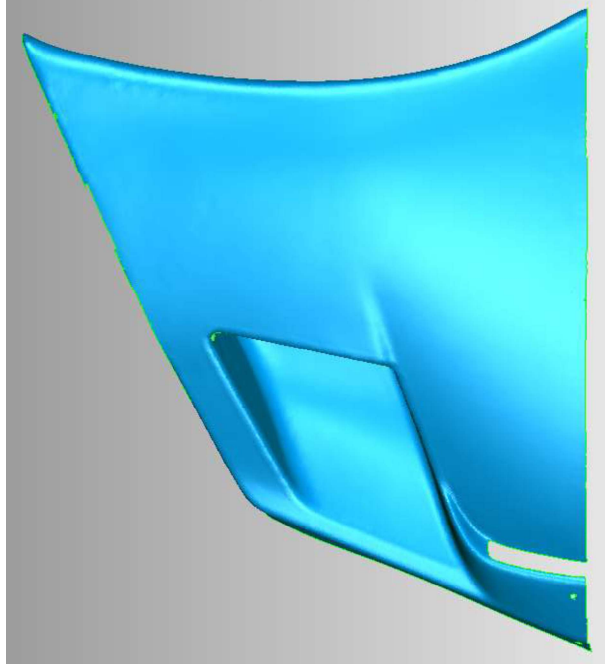

Figure 95

3. This is a good time to save your work. Click the **Application Button** at the top left of the application and select **Save As** from the application menu.
 - Navigate to the **Desktop** in the **Save As** dialog and change the **File name** to **Fairing**.
 - Click the **Save** button.

End of Activity

Context Menus

Geomagic Essentials has several context menus activated by right-clicking in one of three locations; at the top of the screen on a user interface element, on an object in the **Model Manager Panel** tab and in the **Graphics Window**.

User Interface Context Menu



- Quickly add any command to the **Quick Access Toolbar**.
- Display the **Quick Access Toolbar** below the ribbon.
- Hide the ribbon; reappears when a tab is clicked.

Model Manager Context Menu

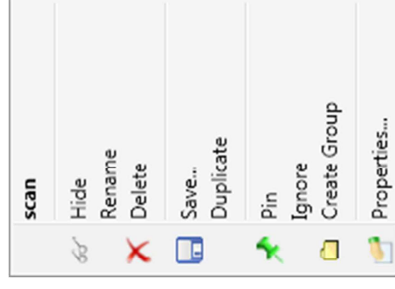

- Display's the name of the selected object.
- **Hide** the object in the **Graphics Window**; if the object is currently hidden the menu will display the **Show** option.
- **Rename** the selected object; this can also be done by double-clicking the object in the **Model Manager Panel** tree.
- **Delete**, removes the selected object from the current session – this action cannot be undone.
- **Save** the current object out to a file in one of the supported formats for the data type of the object.
- **Duplicate** creates an exact copy of a top level object on the tree; if the object has branch nodes they will also be copied. Useful for creating duplicates for alternative workflows or a backup object.
- **Pin/Ignore**; Used only for **Global Registration** command. **Pin** will constrain the location of the selected object. **Ignore** is useful when a one or more of scans are in a group and you do not want them used in **Global Registration** command.
- **Create Group** creates a folder object on the **Model Manager Panel** tree that can be used to store objects of the same data type.
- **Properties...** displays the properties of the selected object, useful when a **Feature** object is selected.

Graphics Window Context Menu



- ☉ With no selection made in the **Graphics Window** a context menu of commonly used view and selection commands are available.

☞ Default right-click menu shown.



- ☉ With a selection made in the **Graphics Window** a context menu with data sensitive shortcuts is added to the top of the context menu.

☞ Polygon context menu shown.

Search

The **Search Box** at the top right corner of the application builds a ribbon based on what is typed into the text box. The example in **Figure 20** shows the word **feature** typed into the **Search Box** and the ribbon that is dynamically created with commands that contain the text string.

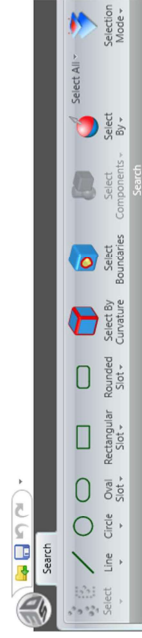

Figure 20

Clicking the “X” in the **Search Box** will remove the search ribbon and restore the previous ribbons.

4. **Zoom** to the area with the small holes shown in **Figure 93**. In the **Hole Selection** roll-up group of the **Fill All** dialog toggle on the **Maximum Circumference** parameter by placing a check in the checkbox. The numeric field below it will become active.

☞ In the **Overlay**, **Hole Circumference** information is displayed when the **Maximum Circumference** parameter is activated.

- **Cursor** over a few holes, you will see the information change dynamically as you pass over a hole boundary.

- Hover the cursor over the hole shown in **Figure 94** and **LMB click** the boundary.

☞ The **Maximum Circumference** parameter updates to the size of the selected boundary and only holes smaller than the selected hole will remain highlighted in red. The **Selected Holes** information in the **Overlay** will also update.

☞ Any hole boundaries of the same or less size than the number entered into this field will be excluded from the **Fill All** operation.



Figure 93



Figure 94

5. Click **Apply** in the **Fill All** dialog to fill the **Selected Holes**.
6. Toggle the **Maximum Circumference** parameter **off** in the **Fill All** dialog, the remaining holes will again be selected.
7. Click **Apply** to fill all remaining holes.
8. Click **OK** to exit the dialog.

Fill All



1. Click **Scan > Fill Holes > Fill All** on the ribbon. The **Fill All** dialog will start and the number of **Selected Holes** will be displayed in the **Overlay** of the **Graphics Window**.
There are several small holes scattered throughout the mesh, the Fill All command can be used for these smaller holes.

➡ **Notice that ALL boundaries are counted, including the entire outside perimeter of this object.**

- In the **Hole Selection** roll-up group, click the **up arrow** at the right side of the list next to **Selected Largest**. The largest boundary is deselected; notice that **Selected Holes** changed in the **Overlay**.
 - Click the **up arrow** again. The next largest boundary (air duct) will be deselected and removed from the count in the **Overlay**.
2. Locate the holes in **Figure 92**; the boundaries are **red**, which means they will be filled if not deselected. Hover the cursor over one of them; hold the **CTRL** key down while you **LMB** click the boundary.
 - The hole boundary will be deselected and removed from the hole count, perform the same operation on the other hole shown in **Figure 92**.

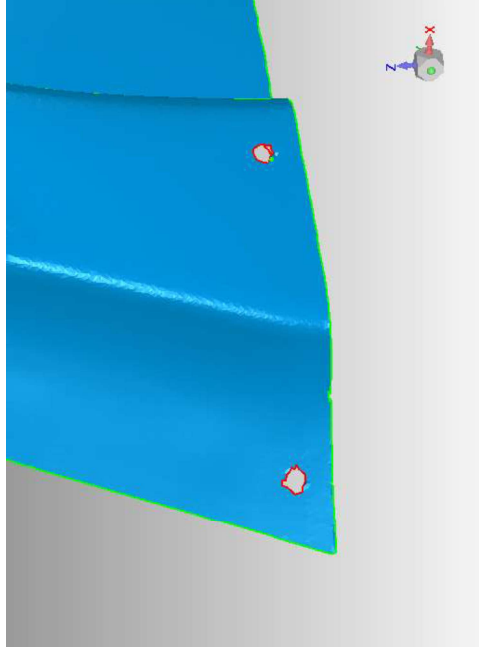

Figure 92



3. Select **Right View** from the **Predefined View** fly-out on the **Right-Side Toolbar**.

Help

Help Dialog

Pressing the **F1** key will open a help dialog that contains Contents, Index and Search commands.

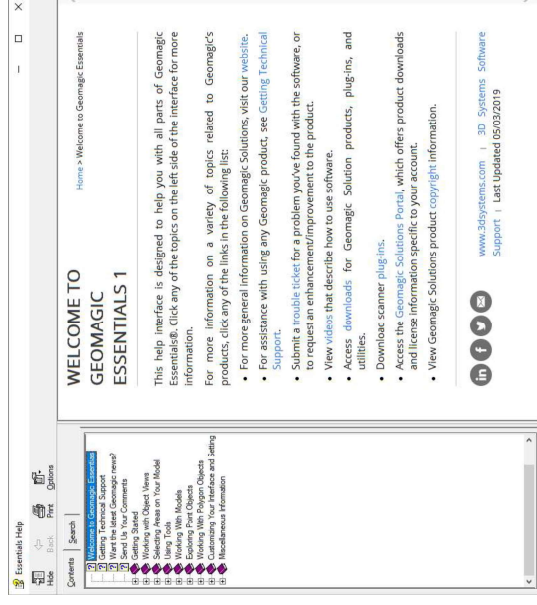

Context Sensitive Help

Placing the cursor over any icon and pressing the **F1** key will invoke help for that command. When a dialog is active; placing the cursor anywhere in the dialog and pressing **F1** will invoke help for the command active in the dialog.

Data Types

The application supports several data types including collected point data, polygon data and surface data.

Point clouds are common data types which consist of individual point locations. The application can import several hardware device native file formats and also provides plug-ins for several hardware devices, enabling direct input of scan data into the application.

Unordered Point Data

- Unordered or raw point data is a collection of points, each having an X, Y, Z location. When viewed up close, unordered point data is semi-transparent.
- Unordered point data may contain normal/vector information or not, point data which contains no normal information will be black in color, as shown in **Figure 21**. The same point data after shading is shown in **Figure 22**.
- Shading point data enables a better view of the shape. When point data is shaded, the default color becomes light green in color.

☞ Data collected using a scanner plug-in is automatically shaded.

Shading can be applied to an unshaded point object in one of two ways:

- **Points > Repair > Shading > Shade Points**
- **Points > Repair > Shading > Repair Normals**



Identifies an object in the **Model Manager Panel** as unordered point data.

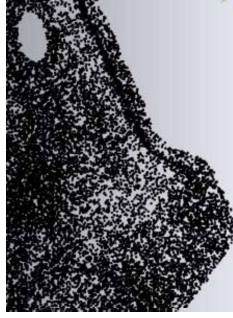

Figure 21 - Unshaded Point Data

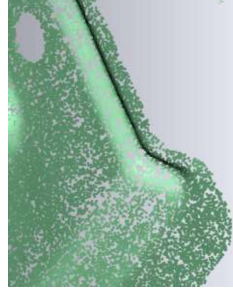

Figure 22 - Shaded Point Data

*☞ When using **Repair Normals** for the first time on an unshaded object, you may be presented with a continuation dialog box – this dialog should be answered “Yes” if encountered to allow access to the entire command.*

11. Locate and navigate as necessary to make the selections shown in **Figure 91**.

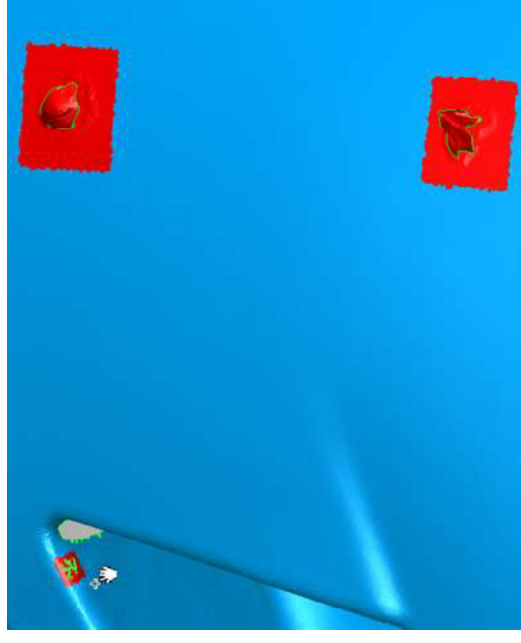

Figure 91



12. After making the selections, press the **DEL** key to remove the selected triangles.

13. Floating triangles are uncovered in the areas where you made your selections. You can remove floating data while still in the **Fill Single** command.

- **RMB** click to bring up the **right-click menu** hole editing commands again and click on **Delete Floating Data**. All floating triangles will be removed.
- **RMB** click again and select **Fill** from the **right-click menu**.



14. On the ribbon, select **Complete** mode and verify that the **Curvature** technique is selected.

15. Move the cursor over a boundary in each area where the selected triangles were deleted and **click** each boundary to fill each hole.

16. You have completed filling single closed and partial holes; it is time to switch to **Fill All** for the remaining holes.

- Click the **Fill Single** icon on the ribbon to exit the command.

7. **Rotate/Zoom** the view as shown in **Figure 89**.

- While in filling mode a different **right-click menu** is available. **RMB** click in the **Graphics Window**.
- From the **right-click menu** click **Select Triangles**; You are placed in selection mode; using your selection tools, select triangles as shown in **Figure 89**.

Hole filling re-builds curvature better when the hole boundary is a rectangular in shape.



Figure 89



8. Press the **DEL** key to remove the selected areas.
9. **RMB** click in the **Graphics Window** again and select **Fill** from the **right-click menu**.
 - **Select** the top left corner for the **1st point** and the top right corner as the **2nd point** to create the boundary shown in **Figure 90**.

Pressing the ESC key after points are selected in a partial fill mode will deselect the points to start a partial fill over.

- **Click** on the **red** boundary to complete the partial fill.

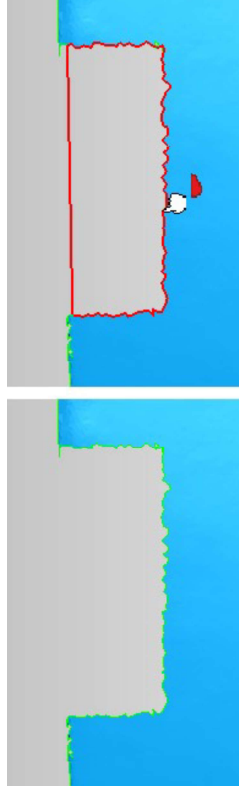

Figure 90

10. **RMB** to bring up the **Fill Holes** editing commands.
 - Click **Select Triangles** from the **right-click menu**.

Ordered Point Data

- Ordered point data is averaged into a cell/grid format and does not contain as many points as unordered point data.
- Unlike unordered point data, you cannot see through a point cloud of ordered point data because of the cell structure.
- Ordered point data spacing is always uniform with a grid like structure and is also green in color when viewed in the application.
- Ordered point data has a different set of point tools than unordered point data.
- When multiple ordered point data scans are combined into a single point object, the result is an unordered point cloud.



Identifies an object in the **Model Manager Panel** as **ordered** point data.



Figure 23 – Ordered (Cell) Point Data

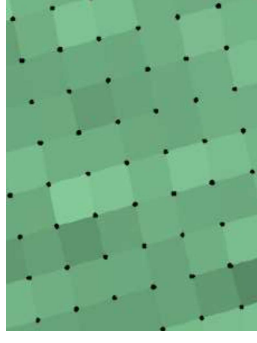

Figure 24 – Cells with Points Displayed

Polygon Data

Polygon data is sometimes referred to as a mesh; triangles are formed by linking point data that result in a mesh. Polygon data comes from a variety of sources that include modeling software, scanning devices and a result of wrapping points in **Geomagic Essentials**.

- When a polygonal object is generated the normal faces are colored blue by default, the back face or opposite side of the normal face is colored yellow.
- If the mesh of a polygon object is modified, the underlying point structure will likewise be modified.
- In the event that any polygon object normals are inverted either from other software or from the wrapping process in **Geomagic Essentials**, use **Scan > Repair>Remesh > Flip Normals** on the ribbon to reverse the orientation of normals.

Identifies an object in the **Model Manager Panel** as polygon data.



Figure 25 – Polygon Object Normals Correct

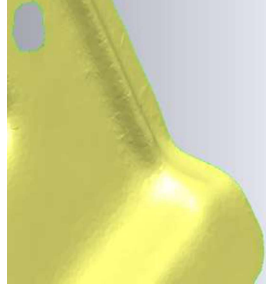

Figure 26 – Polygon Object Normals Inverted

Clicking the **Display Panel** tab and toggling on **Edges** in the **Geometry Display** roll-up group will reveal the mesh construct of any polygon object.

An optimized mesh has a higher ratio of triangles in areas of high curvature to low curvature. An optimized mesh retains the proper shape description; see **Figure 27** and **Figure 28**.



Figure 27 – Uniform Mesh

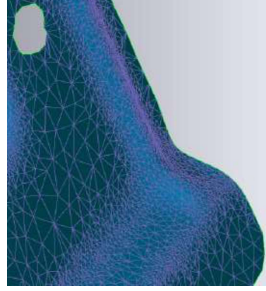

Figure 28 – Optimized Mesh

A polygon object can also be changed into the point object.



Scan > Convert > Convert to Points on the ribbon changes a polygon object into an unordered point object.

4. As you move the cursor to the other corner, the boundary area to fill will dynamically highlight in red. The red dot will snap to triangle vertices as you move over them.

- Place the cursor at the other corner of the cut-out as shown in **Figure 87**.
- **LMB** click at this corner, this locates the **2ND** point on the boundary.

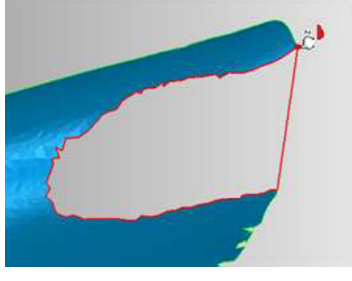

Figure 87

5. Hover the cursor in the **red** bounded area as shown in **Figure 88**.

- **LMB** click in this area or on the boundary to apply the fill to the area outlined in red.



Figure 88

6. You are still in **Fill Single/Partial** mode; select the **Curvature** technique on the ribbon.





Figure 84

1. **Rotate** the view to the other end and locate the hole shown in **Figure 84**.
 - **Hover** the cursor over the boundary, it will turn red.
 - **LMB** click the red boundary and the hole will be filled.
 - Filled holes are shown in red, in the **Fill Hole** group, toggle **Show Fill** off to see the hole as it will appear once you exit hole filling. Toggle **Show Fill** back on.

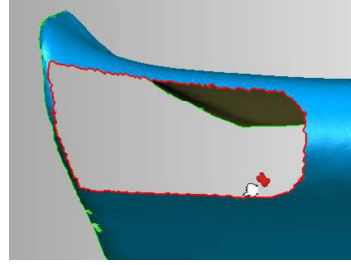

Figure 85

2. **Rotate** and **Zoom** to the view shown in **Figure 85** at the upper right corner where you deleted triangles earlier.
 - **Hover** the cursor over the boundary, and **LMB** click; the hole will be filled.
 - This is not a good fill, press **CTRL+Z** to undo the fill.

You can CTRL+Z to undo any fill, the limit that may be undone is 10.

- Select **Tangent** as the **Fill Technique** on the ribbon. This will keep the filled curve from projecting too far.
- **Hover** over the boundary again and **LMB** click; the hole will be filled.

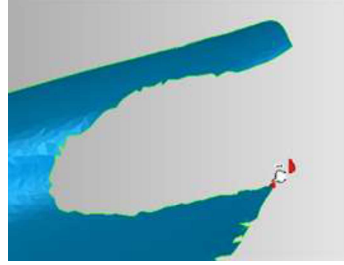

Figure 86

3. **Rotate** and **Zoom** the view to the lower right corner where you deleted triangles earlier.
 - Select **Partial** as the **Fill Mode** on the ribbon.
 - As you hover near the corner of the cut-out, a red dot will appear as shown in **Figure 86**.
 - **LMB** click at this corner, this locates the **1st** point on the boundary.

NURBS Data

NURBS is a type of surface and is produced by the command **AutoSurface**.

- NURBS is an acronym for **Non Uniform Rational Bezier Spline**.
- A polygon object is required to create a NURBS structure in **AutoSurface**.
- An object that has had NURBS based surfacing applied in **AutoSurface** is olive green in color.
- An object that has had NURBS based surfacing applied in **AutoSurface** may be down converted to a polygon object.



Identifies an object in the **Model Manager Panel** as **AutoSurface** data.

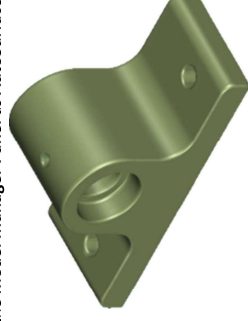

Figure 29 – NURBS data generated by **AutoSurface**

Curve Data

Curve data is analogous to wireframe geometry; it can be either drawn directly or extracted from a model. Curve data has many properties:

- Curves can be drawn manually.
- Curves may be converted to **Free Curves**.
- Curves may be converted to **Boundaries**.
- **Free Curves** can be projected onto polygon models.
- Curves may be defined by a section cut.
- **Free Curves** may be saved in **IGES** format.



- Identifies an object in the **Model Manager Panel** as **3D Curve** data.
- Identifies an object in the **Model Manager Panel** as **2D Curve** data.

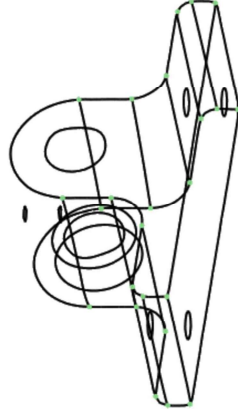

Figure 30 – Curves

Filling Holes



1. There are two ways to fill holes; **Fill All** and **Fill Single**. **Fill All** finds all boundaries and does as the name implies. **Fill Single** interacts with each hole; you can also change either/both the **Technique** and **Mode** as desired in **Fill Single** mode.



- **Fill Techniques** control the curvature of a fill.

• *Curvature filling starts tangent to edges and ends tangent based on curve projection.*

• *Tangent filling starts tangent to edges and projects a flattened curve.*

• *Flat filling is as the name indicates.*

- **Fill Modes** control the way a hole fill occurs.

• *Complete fills a closed boundary.*

• *Partial fills between two selected points and an included boundary.*

• *Bridge fills from selected triangles edges to selected triangle edges.*

Fill Techniques



Figure 82

Fill Modes

Fill Single



1. Click **Scan > Fill Holes > Fill Single** on the ribbon.

- Verify that **Curvature** technique and **Complete** mode are active.

2. **Rotate** the view as shown in **Figure 83**.

- **Hover** the cursor over the boundary. It will turn red.
- **LMB** click the red boundary and the hole will be filled.

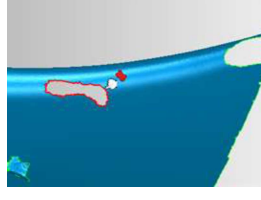

Figure 83

- View the object from different viewpoints using zoom and rotate.
 - Click **OK** to accept the noise reduction.
 - The fairing should appear similar to **Figure 81**.
 - Change the light source using **ALT+LMB** for a better view.

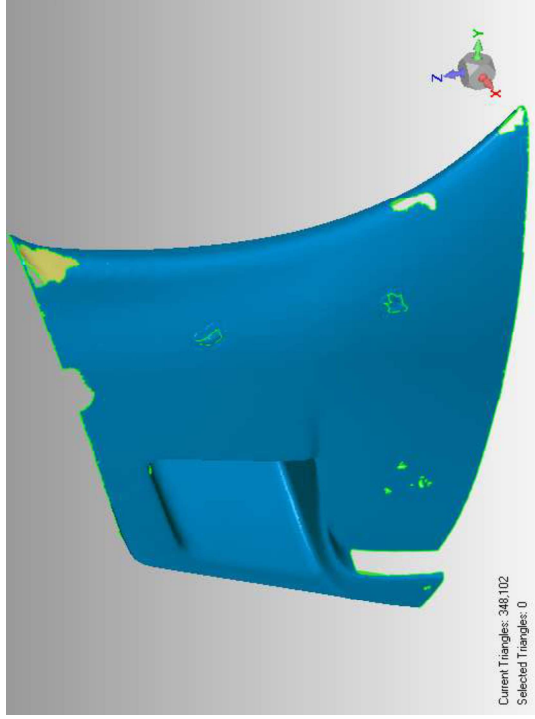

Figure 81

Mesh Doctor



- Click **Scan > Repair > Mesh Doctor** on the ribbon.
 - The Mesh Doctor detects a wide variety of mesh issues and provides numerous methods for resolving them. Mesh Doctor will not analyze a pre-selection; the entire mesh will always be analyzed.*
 - With **Auto-Repair** selected in the **Type** group, remove the checkmark from the **Small Holes** checkbox and place a checkmark in the **Small Tunnels** checkbox in the **Analysis** roll-up group.
 - Click the **Apply** button.
 - We turned off the Small Holes check so we can control filling with the Fill Holes command.*
 - Mesh Doctor will perform the repairs selected in the Analysis roll-up group.*
- Click **OK** once repairs are complete.
 - The Advanced roll-up group of the Mesh Doctor contains the parameters used in mesh analysis.*

Scan Registration

Overview

The process of registration provides the ability to align scans with different coordinate systems.

Manual Registration (1-Point)

One point registration allows the user to align multiple scan objects using a single pick location that is common between the Fixed and the Float views in the same view orientation.

ACTIVITY: Scan Registration (Unordered Point Data)

Objective

In this activity you will align scans of unordered point objects using **Manual Registration**, refine the alignment using **Global Registration** and combine the individual scans into a single object for more processing. The scan data used in this activity is typical of raw (unordered) point data scans of a part scanned in different set-ups.

Commands

- Manual Registration
- Global Registration
- Combine Point Objects

Training File

TR-01.wrp

Open Data



- Open training file **TR-01.wrp**.
 - Click the **Getting Started** tab and select **Open** from the **Tasks** list.
 - Use the **Open Files** dialog to navigate to the folder where the training files reside. Select **TR-01.wrp** in the **Open Files** dialog.
 - Click **Open** to open selected file.
 - Both scan objects should be active when the file is opened. If they are not active, make them active by **CTRL+LMB** clicking them in the **Model Manager Panel**.



Figure 31

- Click **Points > Scan Registration > Manual Registration** on the ribbon to start the **Manual Registration** command.
 - The Graphics Window will be divided into 3 view ports. The upper left view port is the Fixed view port and the upper right view port is the Floating view port. The wide frame at the bottom serves as a preview after registering the object in the Floating view port to the object in the Fixed view port.*
- Select the **1-Point Registration** radio button in the **Mode** roll-up group if it is not already active.

4. Define **Fixed** and **Floating** objects to align.

- From the **Fixed** list in the **Define Sets** roll-up group, select **Scan 001**. The selected scan will turn red and appear in the **Fixed** view port (top left view).
- From the **Floating** list in the **Define Sets** roll-up group, select **Scan 002**. The selected scan will turn green and appear in the **Floating** view port. (top right view)

The Fixed and Floating objects selected in the lists will appear in the Fixed and Floating frames similar to Figure 32.

*There are two sides to each scan; always make sure you rotate the **dark red** and **bright green** sides of the scans towards you for registration.*

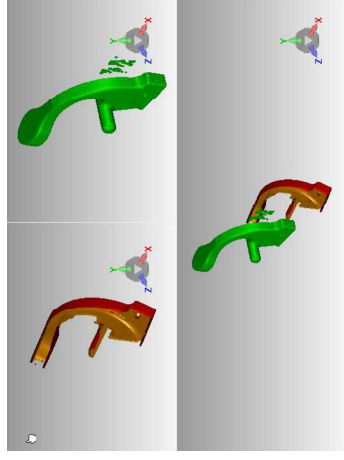

Figure 32

5. Orient **Fixed** and **Floating** views for selection.

- **Rotate** each of the scans to the positions shown in **Figure 33**.

*It is important that the **Fixed** and **Floating** view orientations be as close as possible to each other when using **1-Point Registration** (default), otherwise the registration may not work correctly.*

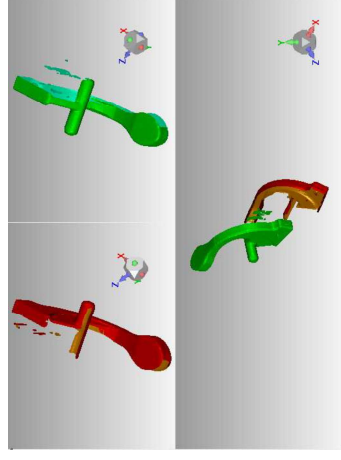

Figure 33



Figure 78

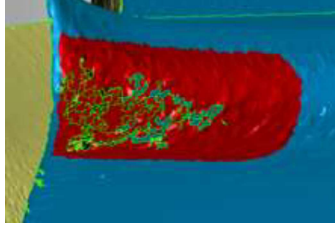

Figure 79

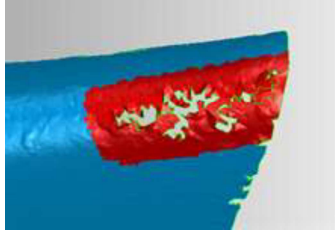

Figure 80

Floating Triangles



1. Click **Scan** > **Repair** > **Manifold** > **Make Manifold (Open)** on the ribbon.

The Make Manifold command located and automatically deleted the floating triangles. Triangles that are not connected by edges to the main mesh are considered non-manifold. Removal occurs without a dialog.

Reduce Noise



1. Click **Scan** > **Smooth** > **Reduce Noise** on the ribbon.
 - Set the type of reduction to **Prismatic shapes (aggressive)**.
 - Set the **Smoothness Level** slider to **3**.
 - Set the **Deviation Limit** in the **Parameters** roll-up group to **0.3 mm**.
 - Click **Apply**.

Noise reduction can be applied to smooth the mesh of this object. Using the Deviation Limit parameter is essential to keeping a polygon model within a presumed tolerance.

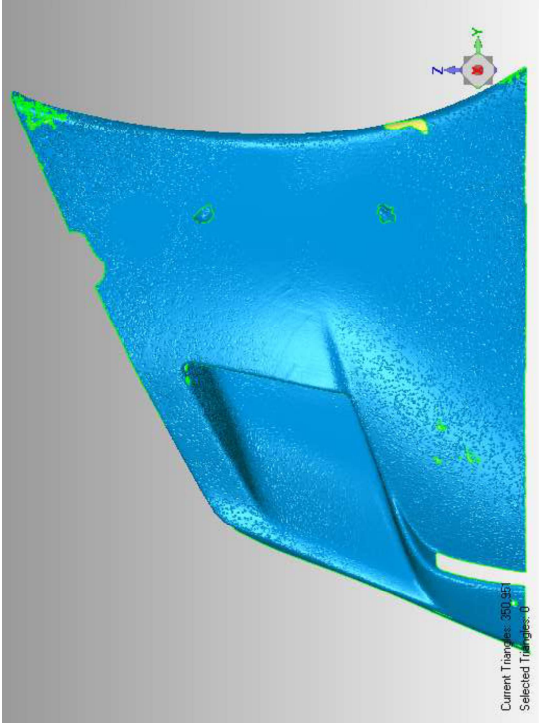

Figure 77

2. **RMB** click on **Fairing** in the **Model Manager Panel** and select **Duplicate** from the **right-click menu**.

A copy of the polygon object will be created in the Model Manager Panel and will automatically be set as active.

Manual Editing

1. Click **Select Backfaces Mode** on the **Right-Side Toolbar** to turn it **OFF** and prevent selecting triangles on the other side of the object.
 - **Zoom/Rotate/Pan** as necessary. Using the **selection tools** on the **Right-Side Toolbar**. Make the selections shown in **Figure 78** to **Figure 80** and **Delete** them. Leave the strip of triangles at the top of the selected area in **Figure 79**.



Manual selection and deletion of poor triangles that affect the mesh will make other repairs easier and more effective.

6. Pick a common point that is available in both the **Fixed** (red) and **Floating** (green) view ports, see **Figure 34**.

If you accidentally pick the wrong point, use the CTRL+Z keys to undo the last selection.

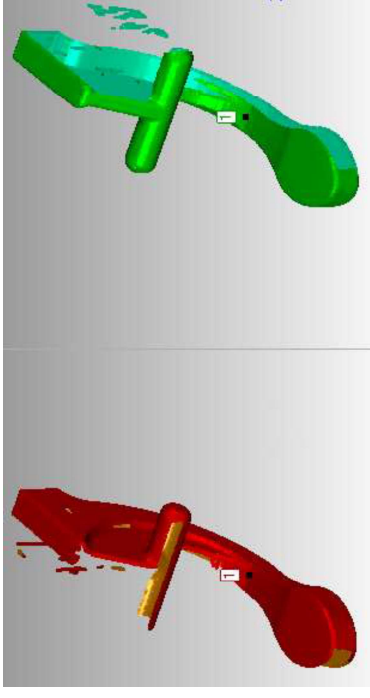

Figure 34

7. When using **1-Point Registration**, registration will start automatically when the second point is picked. If you have performed a successful registration the bottom window will update to show the aligned scans with overlapping data as shown in **Figure 35**.
 - Press the **Register** button to help refine the registration of the current scan.

If the scans are poorly aligned; either the view orientations were not close enough or you did not select registration points near enough to each other and need to try again. If this is the case, click the Unregister button in the dialog to move the scans back to their original positions and start the process again.

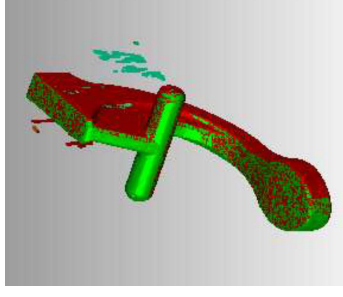

Figure 35

8. When satisfied with the registration, accept the current registration and place the two scans into a group object if there is a checkmark in the **Add to Group** checkbox.
 - Click the **Next** button to accept the current registration.

In this example, please a checkmark in the Add to Group checkbox and use the default name of Group 1.

- Click **OK** to exit the dialog.

9. You will notice in the **Model Manager Panel** that both scans have been placed in **Group 1**.

Global Registration



1. Refine the registration (alignment) between the scan objects.
 - Click **Points > Scan Registration > Global Registration** on the ribbon.
 - Click **Apply** to start the registration process.

The registration process will stop when either convergence is detected or the maximum number of iterations has been reached.

2. After reviewing, click **OK** to accept the registration and exit the dialog.

Combine Point Objects (Unordered Point Data)



1. After registration, the scans are aligned but are still separate and need to be combined into a single point object. Verify that all scans are in a single **Group** in the **Model Manager Panel** and that **Group** is active.
 - Click **Points > Combine > Combine Point Objects** on the ribbon.
 - Name the point object to be created by typing "**Model**" in the **Name** field.
 - Accept the remaining default settings.
 - Click **Apply**.
 - Click **OK** to exit the dialog.

The point object is now ready for further processing.

End of Activity

Polygon Objects

Overview

A polygon model or mesh is a collection of triangles; vertices are where these triangles meet, and the vertices are the same as the underlying point object. If the polygon structure changes, so does the underlying point structure.

An STL file type is synonymous with a polygon model; they are one and the same. An exported STL file can be read by many rapid prototyping, CAD/CAE, and multi-media applications. In some cases, perfecting the polygon model is all that is required. Likewise, many applications can produce STL files and they can be imported to for further processing, surfacing and/or comparisons. Several hardware scanner vendors also produce an STL file as a means of file sharing with external applications.

There are many tools available in polygon mode; from minor touch-up to mesh repair, mesh restructure, deformation, Boolean modeling and curve extraction.

A quality polygon object is also essential for applying CAD or NURBS surfaces, and many of the commands covered in this chapter also serve as a precursor to surfacing. This chapter is designed to introduce you to commonly used commands that improve the quality of a polygon object.

ACTIVITY: Level I

Objective

Learn how to repair a polygon object.

Commands covered in this section include the following:

- **Make Manifold (Open)**
- **Remove Spikes**
- **Mesh Doctor**
- **Reduce Noise**
- **Fill Holes**

Training File

TR-05.wrp

File Open



1. Open training file **TR-06.wrp**.

- Navigate to the training files folder and open **TR-06.wrp**.
- **Zoom** and **Rotate** the view to look at different portions of the polygon object in greater detail.
- Select **Right View** from the **Prefdefined View** fly-out on the **Right-Side Toolbar**.
- Select **Fit Model to View** on the **Right-Side Toolbar**, see **Figure 77**.



4. In the **Inputs** roll-up group, select the **YZ Plane** from the **Fixed: World** list.

- Select the **Side Plane** from the **Float** list.
- Click on **Create Pair**, the alignment will add a subsequent pair in weighted descending order to the **Pairs** roll-up group list. Any misalignment of the **Side Plane** will be displayed as a deviation in the **Statistics** roll-up group.
- In this case the **Side Plane** orients the object in the wrong direction, use the **Flip Plane** button to the right of the **Pairs** list to reverse the normal direction of the **Side Plane**.



5. Create another pair from the **XZ Plane** and the **Back Plane**.

View the information displayed in the Statistics roll-up group, note that the object is fully constrained with no degrees of freedom still remaining.

- Click **OK** to accept the alignment and exit the dialog.

Create a Point of Origin

1. To locate a specific location at the **World CSYS Origin of 0, 0, 0** – a **Point** feature must be created and added to the alignment process.

- Click **Model > Create > Point > 3 Planes** on the ribbon.
- In the **Name** field, change the default name to **New Origin**.
- For Plane 1: **Select the Back Plane** in the **Graphics Window**.
- For Plane 2: **Select the Side Plane** in the **Graphics Window**.
- For Plane 3: **Select the Bottom Plane** from the drop-down list.



2. Click **Apply** to create the point feature.

- Click **OK** to exit the dialog.



3. Click **Tools > Object Alignment > Align To World** on the ribbon.

- In the **Inputs** roll-up group, select **Origin** from the **Fixed: World** list.
- Select **New Origin** from the **Float** list.
- Click on the **Create Pair** button, the pairs are added to the **Pairs** roll-up group list.
- Create a pair using the **XY Plane** and the **Bottom Plane**.
- Create a pair using the **YZ Plane** and the **Side Plane**.

The point feature is now located at 0,0,0 of the World Coordinate System.

4. Click **OK** to exit the dialog.

5. Click through the **Predefined Views** on the **Right-Side Toolbar**.

6. To make this alignment permanent.

- Click **Tools > Move > Reorient Model** on the ribbon.
- Click the **OK** button to confirm you want this orientation to be a permanent change.

End of Activity

Registering Ordered Scan Data

Ordered scan data contains cells, and depending on the scan angle, some cell data may be inaccurate and should be filtered out. The registration of ordered data scans is identical to that of unordered data but there are a few options when handling ordered data that will be covered in the next activity.

ACTIVITY: Scan Registration (Ordered Point Data)

Objective

Align multiple, overlapping scans captured at different positions using the **Manual Registration** command. Refine the alignment using **Global Registration** and combine the individual scans into a single point object. Here is an overview of the steps to create a point object from unaligned ordered data scans:

- Filter out poor cell data per scan that was collected using a poor capture angle.
- Roughly align the scans to place them in the same orientation using manual registration.
- Perform global registration to minimize the deviation between scans.
- Remove overlapping cell data and combine the scans into a single point cloud for more processing.

Commands

- Filter
- Manual Registration
- Global Registration
- Combine Point Objects

Training File

TR-02.wrp

Open Data



1. Open training file **TR-02.wrp**.
 - Click the **Getting Started** tab and select **Open** from the **Tasks** list.
 - Use the **Open Files** dialog to navigate to the folder where the training files reside. Select **TR-02.wrp** in the **Open Files** dialog.
 - Click **OK** to open selected file.

These scans were taken with a scanner which outputs ordered data, meaning the point cloud is formatted in a grid-like arrangement.

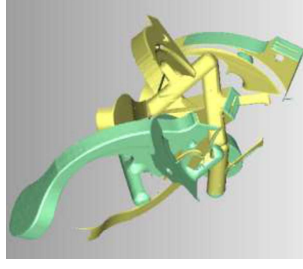

Figure 36



2. If all scan objects are not all highlighted at this time... highlight all of the scans in the **Model Manager Panel** by holding the **CTRL** key while **LMB** selecting each of them.

You can also perform a range selection by selecting the first object in the range, pressing the Shift key and selecting the last object on the range.

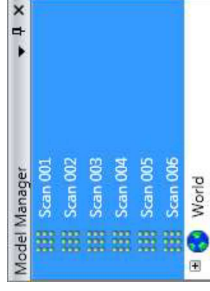

Figure 37

Filter Points

1. Remove cells whose normals are more than a specified degree from the scan direction.
 - Click **Ordered Points > Repair > Filter** on the ribbon.
 - Enter **72.0** into the **Angle** field.
 - Click **Apply** to start filter of data.
 - Click **OK**.

This command is only available when working with ordered (cell) data.

Delete Stray Scan Data



1. Automatically detect and remove small, undesired portions of the scan object.
 - Click **Select > Data > Select By > Area** on the ribbon.
 - In the dialog that appears, enter **2.0** in the **Percent** box.
 - Click **Apply**.

Several of the small segments will get selected. This command selects pieces of the scan that contain less than the specified percentage of that scan's total area.

- Click **OK**.



2. The small segments are still selected so press the **DEL** key to remove them from the scan object.



3. Now that the data has been filtered and edited, you can begin to align the scans. To align these six scans, first make sure they are selected in the **Model Manager Panel**.
 - Select **Scan 001**, press the **Shift** key and select **Scan 006** to specify a range selection which will also activate the selected objects in the **Model Manager Panel**.

Align to World



1. Click **Isometric View** on the Right-Side Toolbar.
2. Setting the **View to Isometric** is an easy way to identify where and how you want to align your model, **Figure 75** illustrates the position of system planes relative to the **Isometric** view.

The three system planes create a corner of a virtual box; you will be placing the data object in the box.

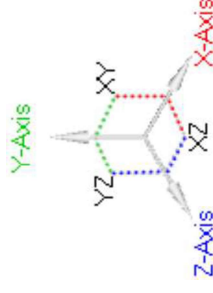

Figure 75



3. Click **Tools > Object Alignment > Align To World** on the ribbon.
 - In the **Inputs** roll-up group, select the **XY Plane** from the **Fixed: World** list.
 - Select the **Bottom Plane** from the **Float: Data Object Name** list.
 - Click on **Create Pair**, the feature plane named **Bottom Plane** and the world **XY Plane**, will appear in the **Pairs** roll-up group list and update the **Statistics** roll-up group, see **Figure 76**.

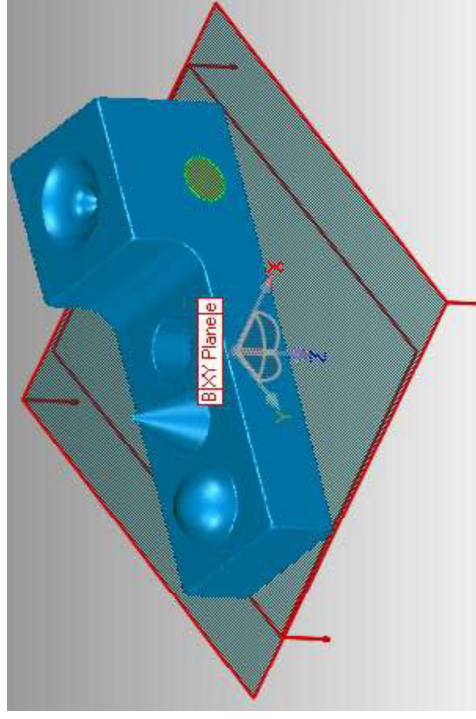

Figure 76

Alignment

Feature objects have many uses including aligning a data object to the **World Coordinate System (World CSYS)**. Having data aligned to the **World CSYS** will make many commands easier to use.

ACTIVITY: Align to World Coordinate System

Objective

Align a data object to the **World CSYS** using **Features**.

Training File

TR-05.wrp

Open Data File

1. Use your choice of methods to access the **Open** command.
 - Navigate to the training files folder and open **TR-05.wrp**.
 - Select **Fit Model to View** on the **Right-Side Toolbar** or press **CTRL+D**, rotate model to the view shown in **Figure 74**.

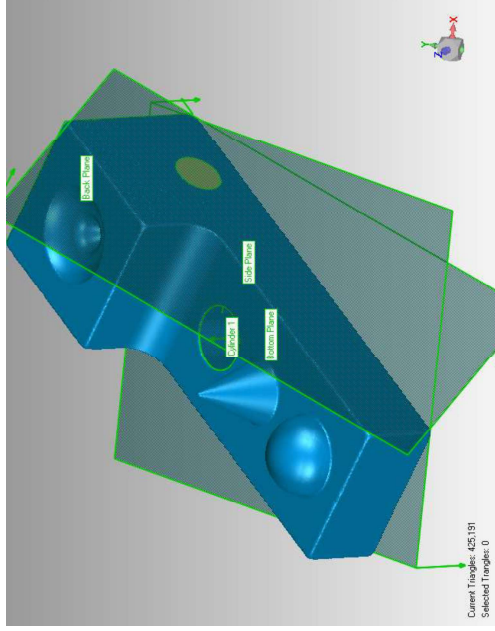

Figure 74

2. Features are required to use the **Align to World** command. Features that may be used world alignments are:
 - **Planar alignments:** Planes, Rectangular Slot and Circle features.
 - **Axial alignments:** Line, Cylinder and Cone features.
 - **Point alignment:** Point features.

Manual Registration (n-Point)



1. Click **Click Points > Scan Registration > Manual Registration** on the ribbon. This command allows you to roughly align multiple scans by picking areas where two scans overlap.
 2. Select the **n-Point Registration** radio button in the **Mode** roll-up group
 3. Define **Fixed** and **Floating** objects to align.
 - From the **Fixed** list in the **Define Sets** roll-up group, select **Scan 001**. The selected scan will turn red and appear in the **Fixed** view port. (top left view)
 - From the **Floating** list in the **Define Sets** roll-up group, select **Scan 002**. The selected scan will turn green and appear in the **Floating** view port. (upper right view)
- The Fixed and Floating objects selected in the lists will appear in the Fixed and Floating frames similar to Figure 38*
- There are two sides to each scan; always make sure you rotate the **dark red** and **bright green** sides of the scans towards you for registration.*

Figure 38

4. **n-Point Registration** does not require exact view orientation like **1-Point Registration** does. **n-Point Registration** requires a minimum of 3 points picked in each view.
 - **Rotate** each of the scans to positions similar to **Figure 39** to see most of the overlapping data.

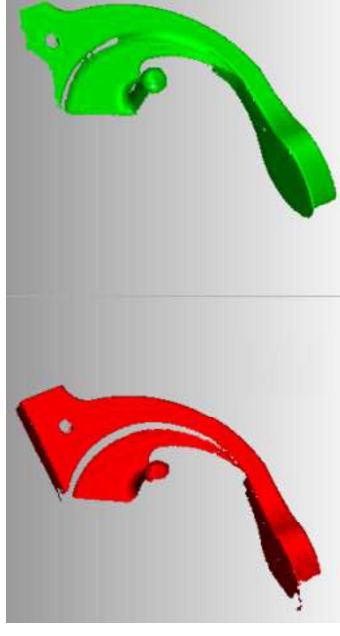

Figure 39

5. Pick the points as indicated in **Figure 40** on both the **Fixed** (red) and **Floating** scans (green) at approximately the same locations on each.

If you accidentally pick the wrong location, press CTRL+Z to undo the last selection.

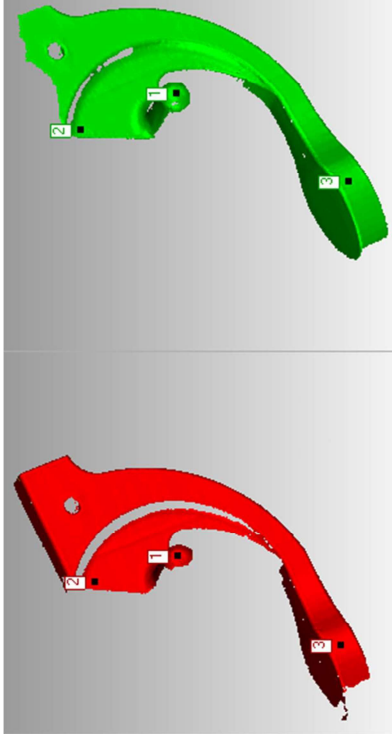

Figure 40

6. A quick orientation of the scan data is done based on the points selected.
- Click the **Register** button to start the registration process.
 - View the fitting of the 2 scans as shown in **Figure 41**.

If the two scans do not appear to be properly aligned but are pretty close, try clicking the Register button again to refine the fit.

If the scans still do not align, click the Unregister button to start again.

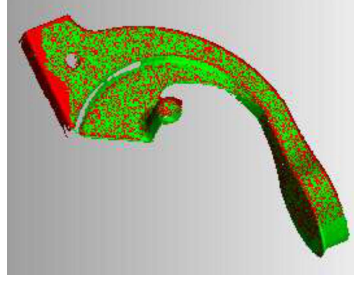

Figure 41

7. When satisfied with your registration, click the **Next** button. This will accept the current registration and place the two scans into a group object if there is a checkmark in the **Add to Group** checkbox.
- In this example, you will have a checkmark in the **Add to Group** checkbox and use the default name of **Group 1**.
 - You will notice that **Group 1** is automatically created and highlighted in the **Fixed** list after clicking the **Next** button.

9. After creating all of the plane features, click **OK** to exit the **Create Plane** dialog.

When creating the same type of feature, clicking Next will keep you in the create features environment to create multiple features.

Circle Feature



1. **Zoom** and **rotate** to the view shown in **Figure 71**.

- Click **Model > Create > Circle > Natural Boundary** on the ribbon.
- Click the **Toggle All Features** icon on the **Right-Side Toolbar** to hide all features.

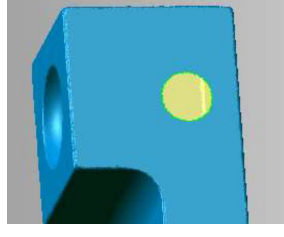

Figure 71

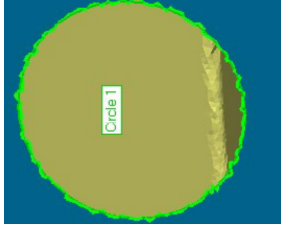

Figure 72

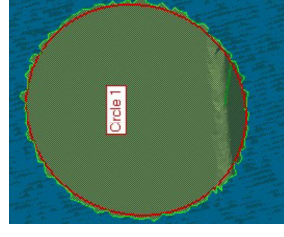

Figure 73

2. **Select** the boundary of the hole; a **Circle** feature will be best fit to the boundary.

- Click **Apply**.
- Click **Next**, to accept the feature.
- Click **OK** to exit the dialog.
- See **Figure 72**.



3. Click **Model > Edit > Edit Features** on the ribbon.

- Select **Circle** from the **Filter** drop-down list in the **Features** roll-up group.
- Select **Circle 1** from the **Name** drop-down list in the **Features** roll-up group.
- In the **Parameters** roll-up group, change the **Diameter** value to **1.125 in** and press **Enter**, see **Figure 73**.
- Click **OK** to exit the dialog.

Any feature may have its properties edited using the Edit Features command.

End of Activity

- Press the **CTRL** key while you deselect the areas shown in **Figure 66**.
 - Click **Apply** to update the feature to the edited selection data.

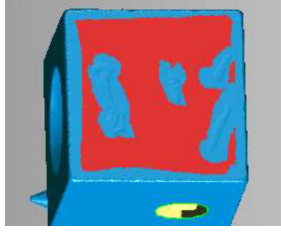

Figure 66

- Click the **Deviations** roll-up group and note the change in the **Maximum Distance** section of the **Statistics** roll-up group.
 - The new display and information should reflect less deviation in the fitted feature as shown in **Figure 67**.

The new display and information should reflect less deviation in the fitted feature as shown in Figure 67.

- Click the **Deviations** roll-up group to deactivate the **Deviations** display.

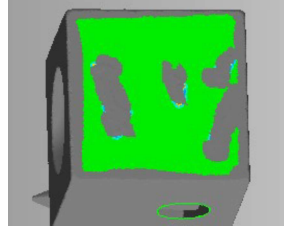

Figure 67

- In the **Name** field, edit the name to **Back Plane**.
 - Click **Apply**, the name of the **Plane** will update in the display.
 - Click **Next**; this will keep you in the **Create Plane** dialog and enable you to create additional **Best Fit** planes.

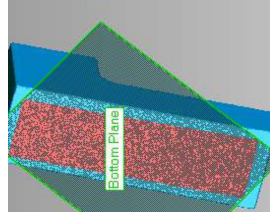

Figure 68

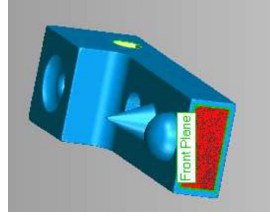

Figure 69

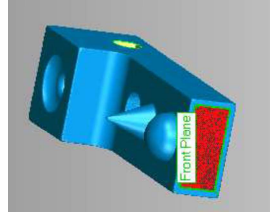

Figure 70

- Make selections and **Name** the planes as shown in **Figure 68** to **Figure 70**. Click **Apply** to create and **Next** to move to the creation of the next plane feature.

- As each **Floating** scan is registered, it will be removed from the **Floating** list and be placed in **Group 1**.
- Leave **Group 1** selected in the **Fixed** list and click **Scan 003** in the **Floating** list to start the registration of the next scan.
 - Rotate the views as necessary to find the overlapping locations to make a selection on.
 - Select approximately the same 3 points in each view port.
 - Click the **Register** button.

- Click **Next** after successfully registering this scan to add **Scan 003** to **Group 1**.

- Continue the previous process and register the remaining scans from the **Floating** list until all are aligned.
 - You will continue to **rotate** the views to locate and use the overlapping areas of the scans to register the remaining scans.
 - Once you have registered the last scan in the **Floating** list, all scans will be visible again.
 - Click **OK** to exit the dialog.



Figure 42

- Look at the **Model Manager Panel** and you will notice that all scans have been placed into a **Group**.

Global Registration



- Refine the registration (alignment) between the scan objects.
 - Click **Points > Scan Registration > Global Registration** on the ribbon.
- Several iterations of an alignment algorithm are run to better align the scans. Statistics will be reported in the dialog after each scan so the user knows the status of the current alignment.
- The operation will terminate when one of three things happen:
- The number of maximum iterations is performed.
 - A specified number of iterations are run without convergence.
 - When the command stops, the system will display the two scans with the greatest deviation in the Statistics group.
- Pressing the **ESC** key at any time during the calculation will stop the command after the current iteration.



2. Analyze the overlapping scan data to see how well the registration worked.

- Click the **Analysis** icon in the **Operations** roll-up group.
- Set the **Density** value to **Full**.
- Click **Compute**.

Once the system is done processing, a colorized deviation map will display how each scan is related to its neighbor.

To speed the process up, set the Density value to something other than Full.

This is useful in reviewing the scans to see if one of the scans is causing the rest to be out of alignment. If so, then you can remove the errant scan from the group of scans and run the Global Registration again.

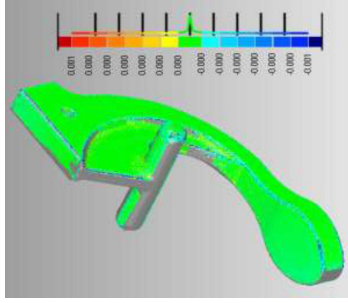

Figure 43

3. Review each scan.

- Select the **Single Object** radio button, and then use the arrow buttons to cycle through each scan.
- After reviewing each scan, click **OK** to accept the registration.

Combine Point Objects (Ordered Point Data)



1. After registration, the scans are aligned but still separate and need to be combined into a single point object. Verify that all scans are in a single **Group** in the **Model Manager Panel** and that **Group** is active.

- Click **Ordered Points > Combine > Combine Point Objects** on the ribbon.
- Name point object to be created by typing **"Model"** in the **Name** field.
- Check the **Remove Overlap** checkbox; this will remove overlapping scan data from the **Ordered Data** objects. This setting only applies to ordered data.
- Notice the number of cells in the **Overlay** area of the **Graphics Window**.
- Click **Apply**.
- Click **OK**; the combined point object is created in the **Model Manager Panel** and the **Group** of scan objects has been **deleted** from the **Model Manager Panel**.

2. Remember that the source data for creating the combined point object was **Ordered Data**. Notice that the newly created combined point object is **Unordered Data**.

The new point object is now ready for further processing.

This is a good place to save your work in a typical workflow.

End of Activity

Plane Feature



1. After creating several features, they may start to clutter the display.
 - Click **Model > Display > Feature Visibility > Toggle All Features** on the ribbon or click the **Toggle All Features** icon on the **Right-Side Toolbar** to hide all features.
 - Clicking the **Toggle All Features** icon again will show all features.
 - Pressing **F9**, performs the same operation.

Individual feature visibility may also be controlled by RMB click; Hide/Show in the Model Manager Panel or from the Feature Visibility stack on the ribbon.



2. Rotate to the view and make the selection shown in **Figure 64**.
 - Click **Model > Create > Plane > Best Fit** on the ribbon.
 - Click **Apply** to create the **Plane** feature.

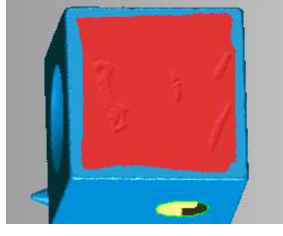

Figure 64

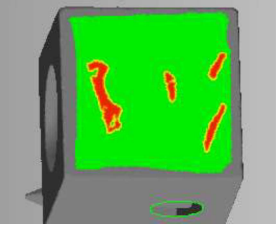

Figure 65

3. Click the **Deviations** roll-up group to activate the **Deviations** sub command.

Note the areas of highest deviation (red) in the color map that is applied to the selected region in Figure 65. This information shows the areas of highest deviation based on the selected area to "best fit" the feature to. Best Fit is dependent on the selection you make, and all data selected will be used in the fitting process.

In the Statistics roll-up group, note the Maximum Distance information.

4. Close the **Deviations** roll-up group up by clicking on the title of the roll-up group again; this will deactivate the **Deviations** display.

2. **Select** around the distorted areas as shown in **Figure 62**. Continue to **select/rotate** to gather as much cylindrical information for the fitting process as you can. Feel free to use other selection tools of your choice.

☞ Avoid selecting data into the round and fillet areas at the top/bottom of the cylindrical face. If you select something accidentally, you can use CTRL+LMB and deselect to refine your cylindrical region.

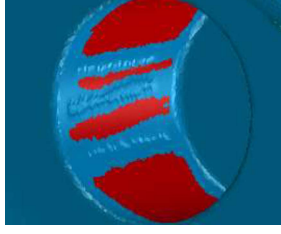

Figure 62

3. Click **Apply** to create the **Cylinder** feature.
4. Click **OK** to exit the dialog.
 - You now have three features as shown in **Figure 63**. Observe the features in the **Model Manager Panel**.

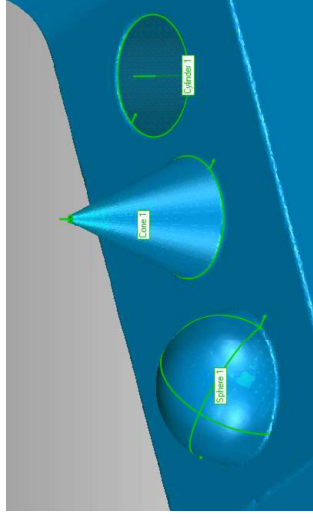

Figure 63

5. Modifying existing features via the **Model Manager Panel**.
 - **RMB** click on the **Cylinder** feature in the **Model Manager Panel**, a **right-click menu** will appear.
 - Select **Edit ...** from the **right-click menu**. The **Edit Feature** dialog is displayed.
6. In **Parameters** roll-up group, the **Direction (axial)** information can be reversed.
 - Click the **Flip** button. The cylinder axis direction will be reversed. Arrowhead is now visible.
7. Change the height of the cylinder by modifying the geometric information of the active feature.
 - In the **Parameters** roll-up group, change the **Height** parameter to **1.5 in** and press **Enter**, the cylinder feature will update in the **Graphics Window**.
 - Click the **OK** button.

Points

Overview

While a point object is active you have the opportunity to improve the scanned data. Noisy data can be improved, and point sampling techniques can be employed to reduce the density of point cloud data.

All cleanup procedures are **optional**, but a “cleaned” point object can be converted to a polygon object with greater efficiency and higher quality. Sampling point objects also improves the computation times of other commands; it is very easy to capture more data than is necessary when scanning a part, more point data is not always “better”.

Commands covered in this section include the following:

- **Select > Disconnected Components**
- **Select > Outliers**
- **Reduce Noise**
- **Uniform Sample**
- **Wrap**

ACTIVITY: Point Data Processing

Objective

Improve and optimize a point object for other operations.

Training File

TR-03.wrp

File Open



1. **Open** training file **TR-03.wrp**.



2. Change view to a previously saved user defined view.
 - In the **Graphics Window**, **RMB** click.
 - Select **User-Defined Views > QuickView 1** from the **right-click menu** to restore the view shown in **Figure 44**.

☞ User-Defined Views can save any view orientation and are instantly available on the right-click menu as they are saved.



Figure 44

Disconnected Components



1. Scanned data often includes points that are isolated from the main point cloud; these types of points are referred to as disconnected components. You will now select these isolated points.
 - Click **Points > Repair > Select > Disconnected Components** on the ribbon.
 - Set the **Separation** parameter to **Low**; observe the number of points selected in the **Overlay**.
 - Set the **Separation** parameter to **High**; observe the number of points selected in the **Overlay**.
 - Set the **Separation** parameter back to **Low**.

A Low setting uses the smallest space between points that will find the most isolated points. The Medium and High settings will find fewer points as the size of the space between isolated points is increased.

2. Click **OK** to exit the dialog; the points detected remain selected.
3. Press the **DEL** key to remove the selected (isolated) points.



Outliers



1. Outlier detection is based on a point to point relationship. The **Select > Outliers** command analyzes each point for proximity to neighboring points based on a sensitivity parameter, as sensitivity increases more outliers are detected and vice versa.
 - Click **Points > Repair > Select > Outliers** on the ribbon.
 - Click the **Apply** button to analyze the point object.

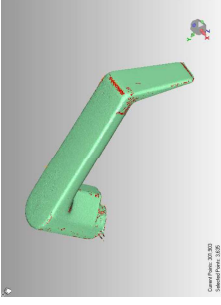

Figure 45

2. Change view orientation to review select points. Also notice the number of points selected in the **Overlay**, see **Figure 45**.
 - **Rotate** the point object and **Zoom** in/out to observe the points selected in the **Graphics Window**.

3. Adjust **Sensitivity** parameter to see how it impacts the number of points selected.
 - Change the **Sensitivity** to **70** and click **Apply**. Review **Overlay** information; notice the **Selected Points** value is lower.
 - Change the **Sensitivity** back to **85** and click **Apply**.
4. Click **OK** to exit the dialog; the points detected remain selected.
5. Press the **DEL** key to remove the selected (outlying) points.



4. **RMB** click on the **Sphere** feature and notice other options on the menu including **Export**.

Any feature may be exported to a neutral file format by this menu option.

Other common options include Rename, Delete, and Edit... on this menu.

- Click anywhere other than the menu to **clear** the menu from the display.

Cone Feature



1. Make the **selection** on the **conical** region in the same way as you did with the **Sphere**; review the **Sphere** steps for reference. The selected region should appear as shown in **Figure 60**.
 - Click **Model > Create > Cone > Best Fit** on the ribbon.
 - Click **Apply** to create the feature.
 - Click **OK** to exit the dialog.

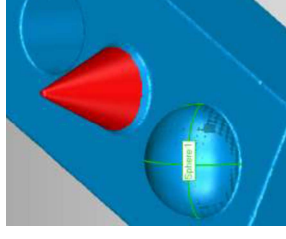

Figure 60

Cylinder Feature



1. **Rotate** and **Zoom** to the view shown in **Figure 61**.
 - Click **Model > Create > Cylinder > Best Fit** on the ribbon.
 - Click **Select Visible** icon on the **Right-Side Toolbar**.
 - Click the **Paint Brush Selection Tool** icon on the **Right-Side Toolbar**.
 - **RMB** click in the **Graphics Window** and select **Set Rotation Center** from the **right-click** menu. **Click** near the edge of cylinder bore; this will make rotation easier while making a cylindrical selection.



Figure 61



- Click **Model > Create > Sphere > Best Fit** on the ribbon.
- The **Sphere** will be fitted to the selected region in **Figure 58**.

The selected area determines the overall size of any best fit feature. Select areas without distortion if possible, the more area selected, the better the fitting process will be.

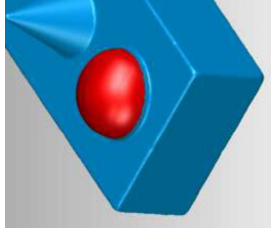

Figure 58

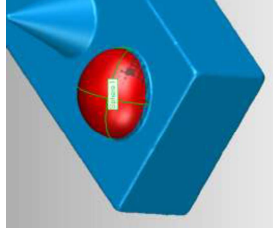

Figure 59

- Click **Apply**.
 - The feature is created with the selected region. See **Figure 59**.
 - Click **Next** to accept the feature.

You could continue to create additional Sphere features at this time.
 - Click **OK**; this will create a new sub-node folder on the **Model Manager Panel** under the active object called **Features**. This sub-node will contain the newly created sphere feature.

Feature Properties

- In the **Model Manager Panel**; expand the current active object node by clicking on the "+" symbol next to it.
 - A **Features** sub-node is created with the first feature created on any object. Expand the **Features** node, the **Sphere** feature just created will appear on the tree.
 - RMB** click on the **Sphere** feature, a **right-click menu** will appear.
- Click **Select Entities**; the selection set used to make the **Sphere** feature will be displayed.
 - Press **CTRL+C** to clear the selection set.
- RMB** click on the **Sphere** feature, a **right-click menu** will appear.
 - Click **Properties** from the menu. A properties dialog containing geometric information about the feature will be displayed. Review the information in the **Parameters** roll-up group and **Fitting Statistics** roll-up group.
 - Click **OK** to exit the dialog.



- It is not required to clean all outliers; however, it is good practice to run this command a few times to get the most outlying points removed from the point object.

- Click **Points > Repair > Select > Outliers** on the ribbon.
 - Use a **Sensitivity** value of **85**.
 - Click **Apply**. Notice that fewer outliers have been detected the second time. Each time **Select Outliers** is used with the same **Sensitivity** value, fewer outliers will be selected.
- Click **OK** to exit the dialog; the points detected remain selected.
 - Press the **DEL** key to remove the selected (outlying) points.

The Select Outliers and Delete commands are usually run in tandem, which makes them a good candidate for a Macro.



Manual Editing



- Zoom, pan** and **rotate** as necessary to locate and manually delete any remaining stray points that may exist around the part perimeter.

See Figure 46 for an example of stray/errant points.

Try using different selection tools from the Right-Side Toolbar.

Remember that CTRL+LMB when using the selection tools, deselects.

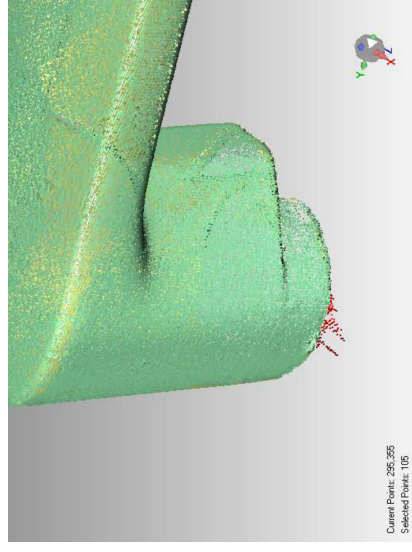

Figure 46

- After selecting stray points, press the **DEL** key.
- Continue to **rotate, zoom, manually select** and **delete** until you are satisfied that only points that describe the scanned part remain.



Reduce Noise

- ➔ **Reduce Noise** is a powerful tool when used properly; if used improperly, it may introduce distortion into a scanned part.



1. Click **Points** > **Repair** > **Reduce Noise** on the ribbon.
 - ☞ *Reduce Noise* is a form of compression that moves points closer together resulting in a smoother polygon object when the points are wrapped.

2. **Rotate** to the view shown in **Figure 47**. Using the defaults,

- Click the **Apply** button.

☞ *Observe the information in the Statistics roll-up group. Staying alert to the Statistics roll-up group will help with assessing how much distortion is acceptable.*

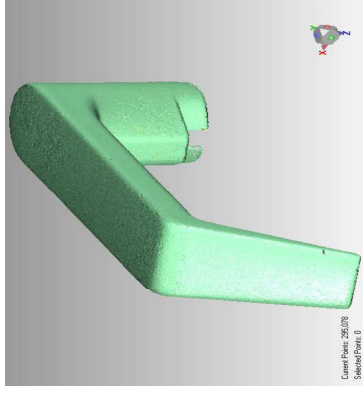

Figure 47

3. Click on the **Preview** roll-up group to expand and activate the **Preview** command.
 - The cursor will change to a cross-hair shape. **Click** near the location shown in **Figure 48**.
 - A polygon preview will be rendered at the area selected as shown in **Figure 49**. **Zoom** in to view the preview in greater detail.

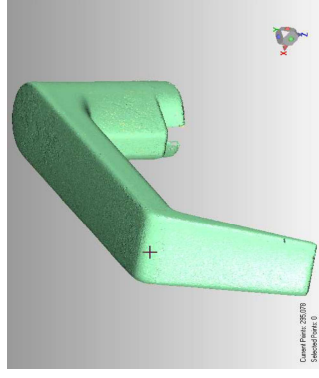

Figure 48

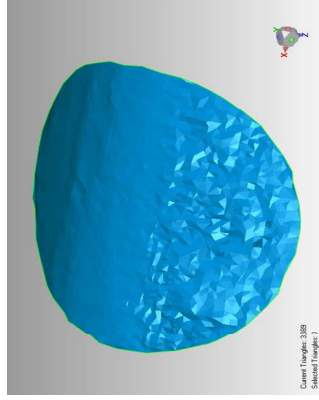

Figure 49

Sphere Feature

1. **Rotate** the view to the side of the part with the open boundary hole, see **Figure 55**.

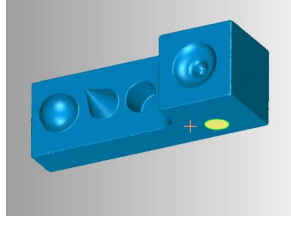

Figure 55

2. Locate your mouse cursor towards the edge of the **Graphics Area** and press the **MMB**
 - Keep the cursor **outside** of the white circle as you move it around the perimeter of the white circle. This will cause the part to rotate parallel to the current view.
 - **Rotate** to the view to the position shown in **Figure 56**.

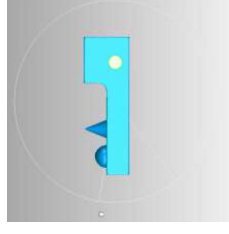

Figure 56

3. Select data for fitting.
 - Click the **Select Through** icon on the **Right-Side Toolbar**.
 - Click the **Rectangle Selection Tool** icon.
 - **Drag** the rectangle to select the area shown in **Figure 57**.
 - **Rotate** to a new view, the spherical region of the part has been completely selected all the way through.



☞ *If the spherical region was not selected all the way through – check that **Select Backfaces Mode** is active and try again.*

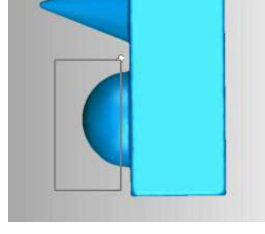

Figure 57

Feature Objects

Overview

Features are 2D and 3D geometric objects created in the application. A feature object contains properties and can be "best fit" to polygon objects by applying them to selected regions. Feature objects can be used for a variety of commands, such as:

- Export to neutral file format like STEP or IGES, which can then be imported into CAD/CAM applications.
 - Mesh re-fit and trimming
 - Alignment
 - Translation to polygon objects for Boolean operations
- Any feature may be edited, re-created from an edited selection set, deleted, and any feature property may be examined. Feature visibility may also be controlled and features may be renamed in the **Model Manager Panel** after creation.

ACTIVITY: Best Fit Features

Objective

Create and edit features using best fit selection data on a polygon object.

Training File

TR-04.wrp

Open Data File

1. Use your choice of methods to access the **Open** command, navigate to the training files folder and open **TR-04.wrp**.
 - **Zoom** and **Rotate** the view to look at different portions of the polygon object in greater detail.
 - Select **Isometric View** from the **Predefined View** fly-out on the **Right-Side Toolbar**.
 - Select **Fit Model to View** on the **Right-Side Toolbar** or press **CTRL+D**, see **Figure 54**.

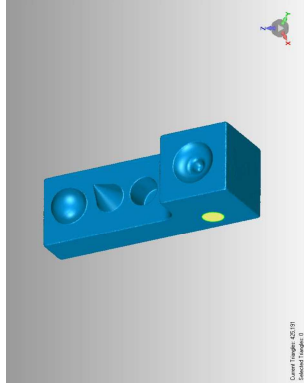

Figure 54

4. With the **Preview** roll-up group still expanded, move the **Smoothness** slider control in the **Parameters** roll-up group to a value of **2**. As you move the slider, the preview will dynamically update to reflect your changes.

5. With the **Preview** roll-up group still expanded, change the reduction type in the **Parameters** roll-up group to **Prismatic shapes (conservative)** and observe how the preview changes.

- Click the **Preview** roll-up group to collapse the group and deactivate the preview.
- **Rotate** and **Zoom** to one or two other locations on the object and at each location; expand, select an area, preview that area and collapse the **Preview** roll-up group to deactivate it.
- If the **Preview** roll-up group is still expanded and active, collapse the **Preview** roll-up group at this time to deactivate it.

6. Click **Apply** to apply the previewed changes to the entire object.

Note: changes of Maximum Distance in the Statistics roll-up group. If this were a high precision part, the amount of noise reduction applied may distort the scan data beyond the tolerance zone of the part.

7. In the **Parameters** roll-up group, enter a value of **0.5mm** in the **Deviation Limit** field.

- Click **Apply**; the scan will be updated with a limit on how far points can move.

Observe the Statistics roll-up group again; the Maximum Distance of any point moved will not exceed the value set in the Deviation Limit field.

• Use the **Deviation Limit** parameter to limit the movement of scanned data.

8. Click on the **Display Deviations** roll-up group to expand and activate the **Display Deviations** command.

The display will change to a deviation map with a spectrum bar, see Figure 50.

- Find the **Max. Critical** input field and change the value to **0.1 mm**. Press the **Enter** key, the **Min. Critical** will automatically update to the inverse value.

- Find the **Max. Nominal** input field and change the value to **0.01 mm**. Press the **Enter** key, the **Min. Nominal** will automatically update to the inverse value.

The display will update the deviation color map and the spectrum bar, see Figure 51.

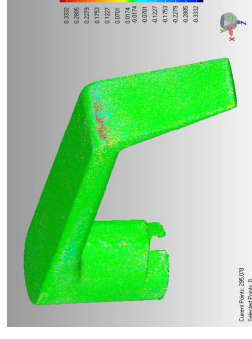

Figure 50

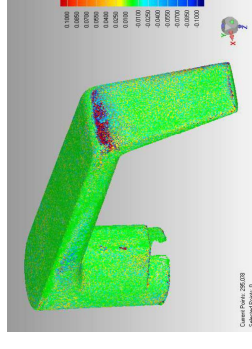

Figure 51

9. Click **OK** to exit the dialog.

Point Sampling

1. Change the density of the point cloud without moving any points.
 - Click **Points > Sample > Uniform** on the ribbon.
 - Select the **Absolute** radio button in the **Input** roll-up group.

2. Orient view in order to see how sampling affects the point cloud.

- **Rotate** and **Zoom** close to your point object, similar to **Figure 52**.
- Note the current number of points in the **Overlay**.
- Click **Apply**.
- Note the change in the **Overlay** and the new density of the point object.

The default sample of Absolute is typically a 45% to 65% reduction of points based on existing density of the point cloud.

3. Adjust spacing parameter.

- In the **Input** roll-up group, select the **Define Spacing by Target** radio button.
- Change the value in the **Points** field to **80,000**. This sets a target of approximately **80,000** points for the sample.
- Click **Apply** and note the change in the **Overlay** and the new density of the point object.

4. Click **OK** to exit the dialog.

➡ *It is possible to over-sample a point cloud; ideally you want to improve the performance of a point cloud while maintaining its shape description.*



Figure 52

Wrap

1. Convert point object to a polygon mesh (STL) object.
 - Click **Points > Wrap > Wrap** on the ribbon.
 - You have already performed a managed noise reduction, locate **Noise Reduction** in the **Settings** roll-up group and set the drop-down list to **None**.

The Wrap command creates triangular faces by “connecting the dots” of a point cloud. The quality of a “wrapped” point object is dependent on the quality of the data it is derived from. Wrapping an unordered polygon object will produce approximately twice the number of triangles as there are points. The triangles in a polygon object are commonly referred to as a “mesh”.

2. Click **OK** to begin the **Wrap** operation.

➡ *When Wrap is applied to ordered point data; no dialog will appear – the point cloud will be wrapped automatically.*

3. A polygon object is created and the point object it was created from remains in the **Model Manager Panel**.



Figure 53

End of Activity