

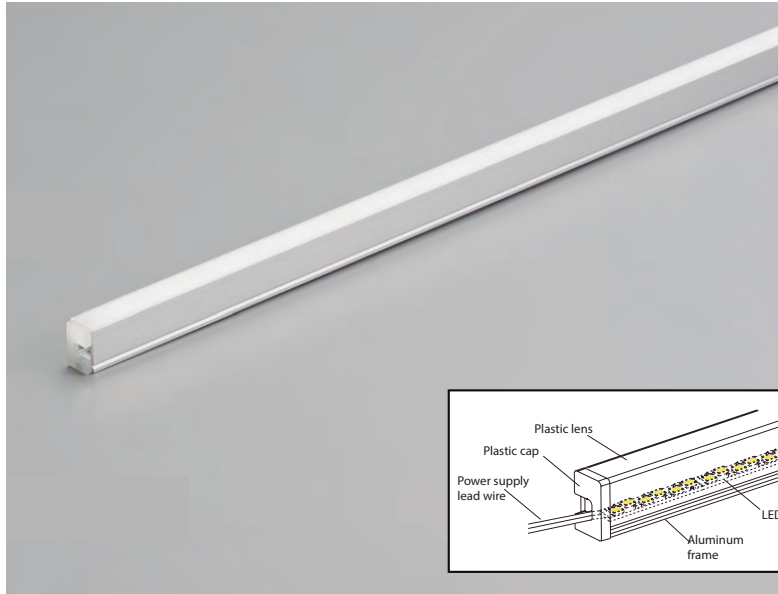

Microtec profile



Microtec M8

- Ultra slim, performance linear lighting module
- Designed to provide superior accent lighting solutions
- Engineered LED configuration achieves pixel free diffusion
- Direct clip fixation
- Magentic fixation option (steel surface)

MODEL		LENGTH	COLOUR TEMPERATURE	Lumens	WATTS
M8 038	Minimum	38mm	2500K	25.3	0.45W
	+ Step	+ 27.5mm	3000K		
			3500K		
M8 1000		1000mm	4000K	910	16W
			4500K		
			5000K		
M8 2485	Maximum	2485mm	5500K	2277	38.7W

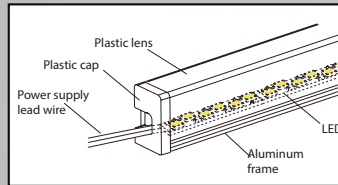

Fixtures Dimensions

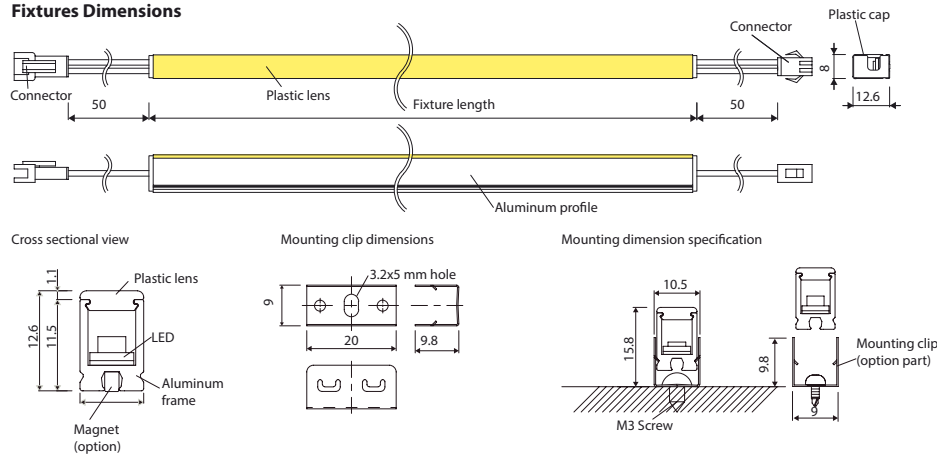

Photometric data

Light Intensity distribution

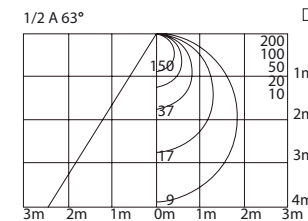

Candlepower Distribution

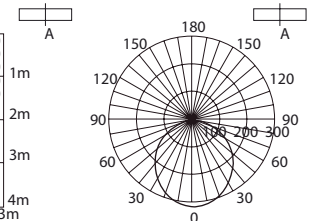

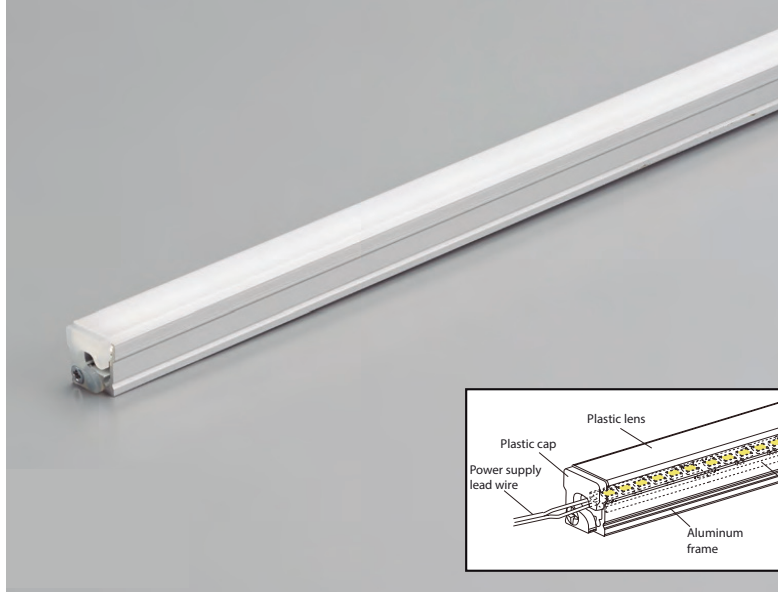

Microtec M12

- Compact, performance linear lighting module
- Designed to provide superior accent lighting solutions
- Engineered LED configuration achieves for Pixel free diffusion
- Direct clip fixation
- Magentic fixation option (steel surface)

MODEL		LENGTH	COLOUR TEMPERATURE	Lumens	WATTS
M12 038	Minimum	38mm	2500K	25.3	0.45W
	+ Step	+ 27.5mm	3000K		
			3500K		
M12 1000		1000mm	4000K	1270	16W
			4500K		
			5000K		
M12 2485	Maximum	2485mm	5500K	3177	38.7W

Fixtures Dimensions

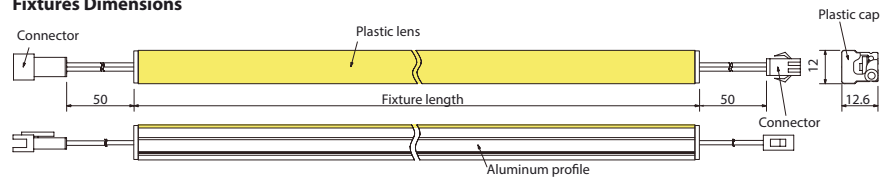

Cross sectional view

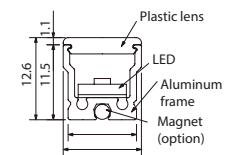

Mounting clip dimensions

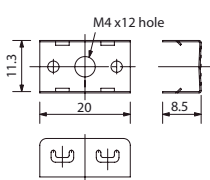

Mounting dimension specification

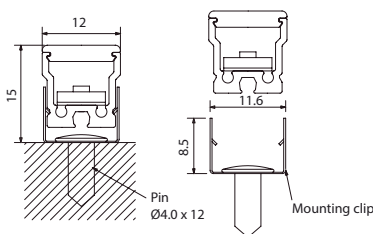

Photometric data

Light Intensity distribution

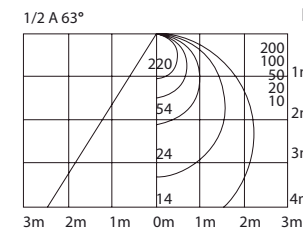

Candlepower Distribution

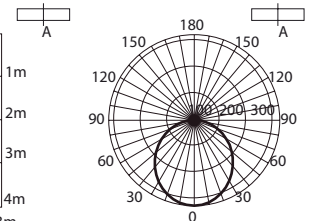



Microtec profile

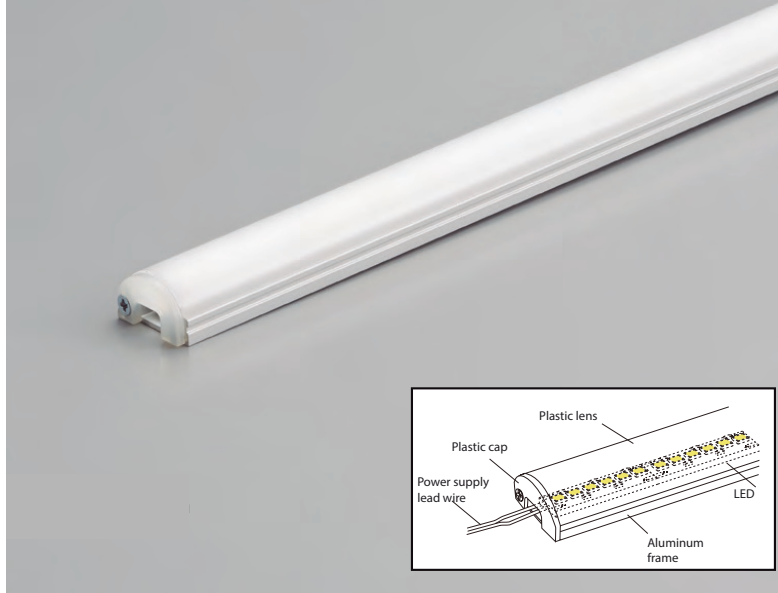

Microtec R20

- Slim bright sided diffuse linear lighting module
- Designed to provide superior accent lighting solutions
- Engineered LED configuration achieves pixel free diffusion
- Direct clip fixation
- Magentic fixation option (steel surface)

MODEL		LENGTH	COLOUR TEMPERATURE	Lumens	WATTS
R20 038	Minimum	38mm	2500K	25.3	0.45W
	+ Step	+ 27.5mm	3000K		
			3500K		
R20 1000		1000mm	4000K	1466	16W
			4500K		
			5000K		
R20 2485	Maximum	2485mm	5500K	3663	38.7W

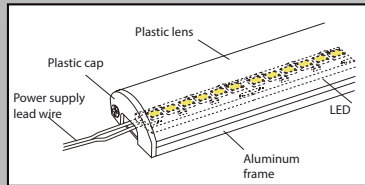

Fixtures Dimensions

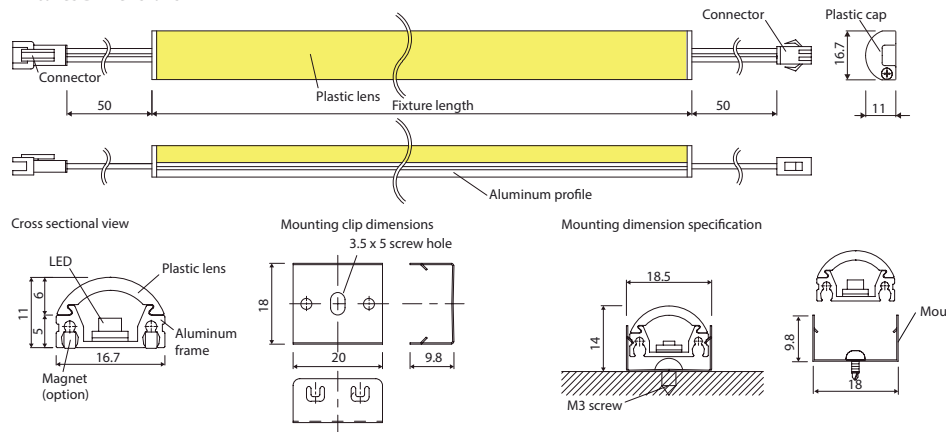

Photometric data

Light Intensity distribution

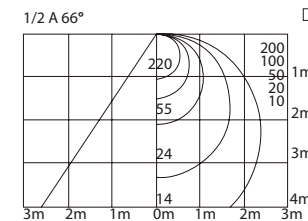

Candlepower Distribution

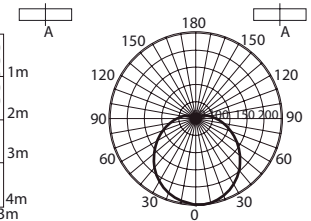



Microtec profile

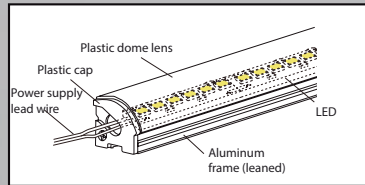
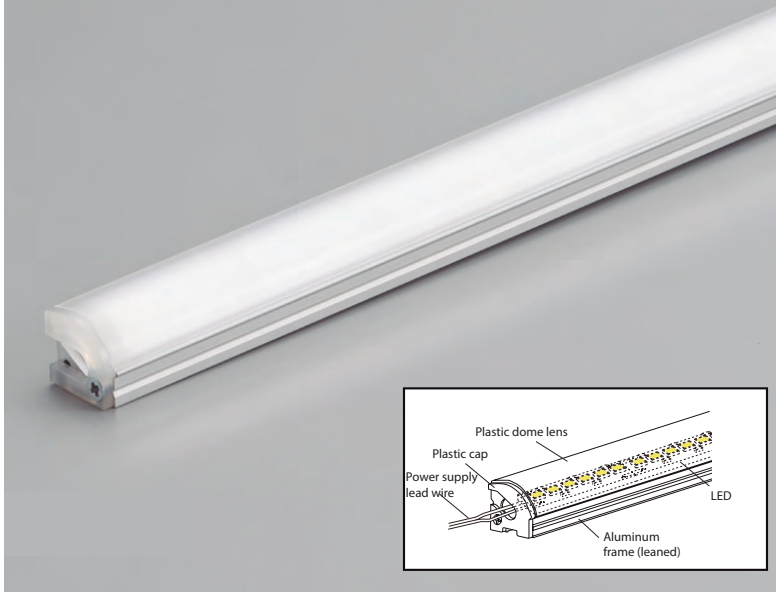

Microtec C16

- Asymmetric throw performance linear lighting module
- Designed to provide superior accent lighting solutions
- Engineered LED configuration achieves pixel free diffusion
- Direct clip fixation
- Magnetic fixation option (steel surface)

MODEL		LENGTH	COLOUR TEMPERATURE	Lumens	WATTS
C16 038	Minimum	38mm	2500K	25.3	0.45W
	+ Step	+ 27.5mm	3000K		
			3500K		
C16 1000		1000mm	4000K	1340	16W
			4500K		
			5000K		
C16 2485	Maximum	2485mm	5500K	3348	38.7W

Fixtures Dimensions

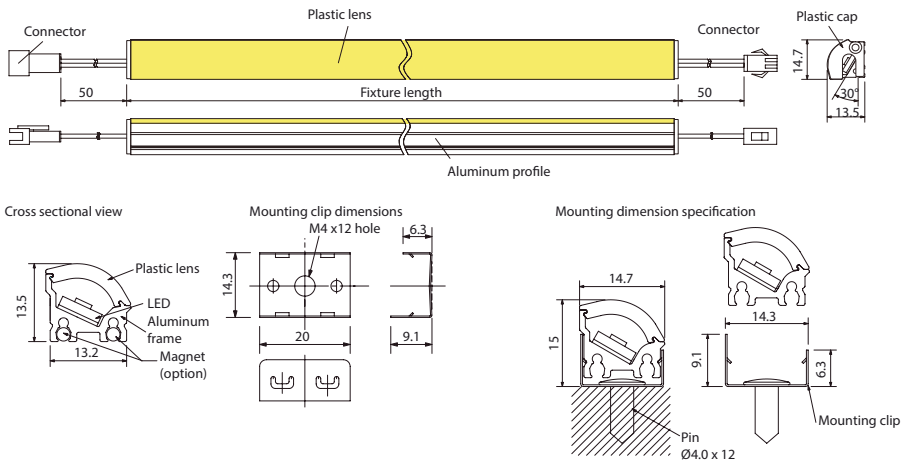

Photometric data

Light Intensity distribution

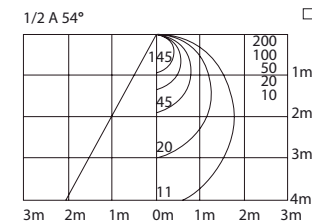

Candlepower Distribution

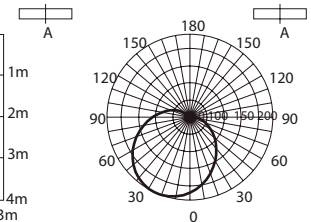



Microtec profile



Microtec RAW15

- Raw performance linear lighting module
- Designed to provide superior accent lighting solutions
- Engineered LED configuration produces high lumen package
- Fixation channel or flat bar heat-sink options
- Extruded aluminium fixation clip option

MODEL		LENGTH	COLOUR TEMPERATURE	Lumens	WATTS
RAW15 038	Minimum	38mm	2500K	25.3	0.45W
	+ Step	+ 27.5mm	3000K		
			3500K		
RAW15 1000		1000mm	4000K	1721	16W
			4500K		
			5000K		
RAW15 2485	Maximum	2485mm	5500K	4302	38.7W

Fixtures Dimensions

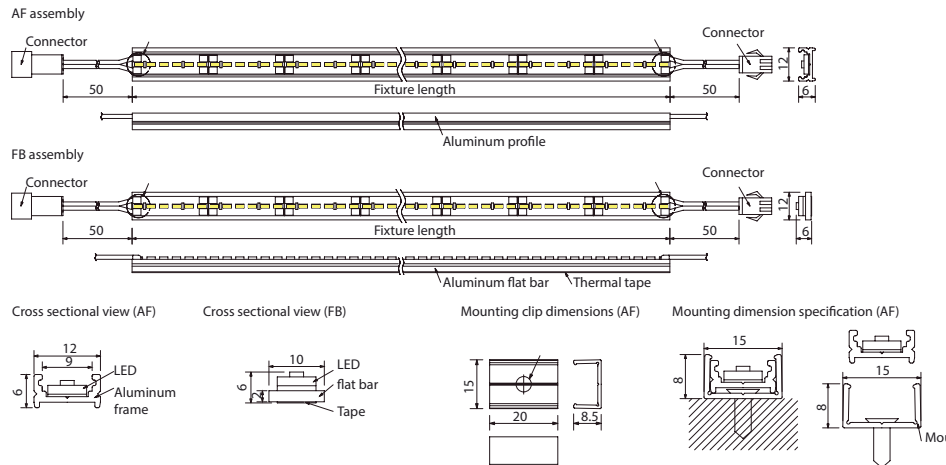

Photometric data

Light Intensity distribution

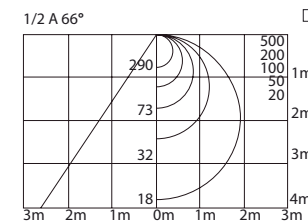

Candlepower Distribution

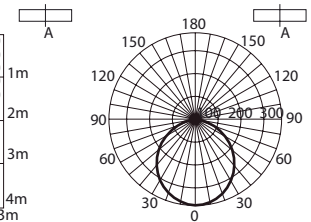



Microtec profile

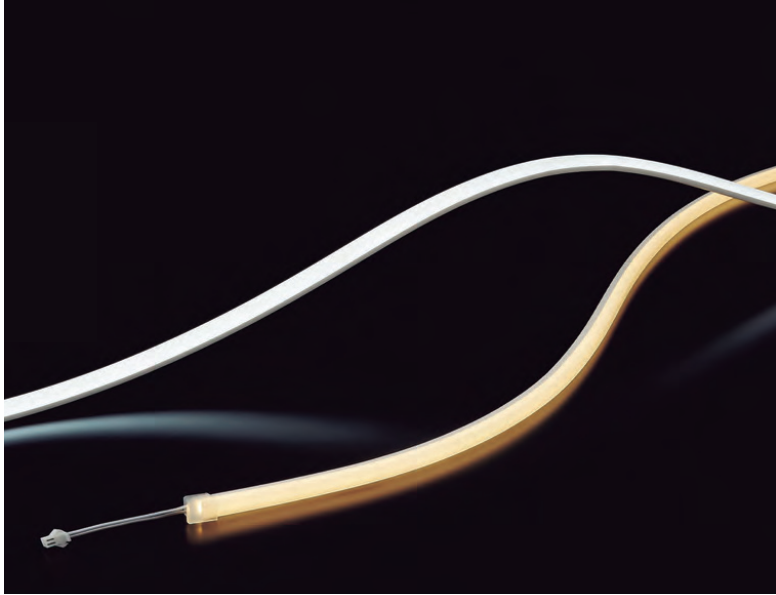

Microtec FT13

- Compact flexible top emitting, IP65 linear lighting module
- Designed to provide tailored accent lighting solutions
- Engineered LED configuration with 50mm cut-down increments
- Fixation channel or flat bar heat-sink options
- Extruded clear acrylic fixation clip option

MODEL		LENGTH	COLOUR TEMPERATURE	Lumens	WATTS
TE13 038	Minimum	58mm	2500K	25.3	0.45W
	+ Step	+ 50mm	3000K		
			3500K		
TE13 1000		1000mm	4000K	780	9.6W
			4500K		
			5000K		
TE13 6482	Maximum	6482mm	5500K	5070	62.4W

Dimensions

Unit (mm)

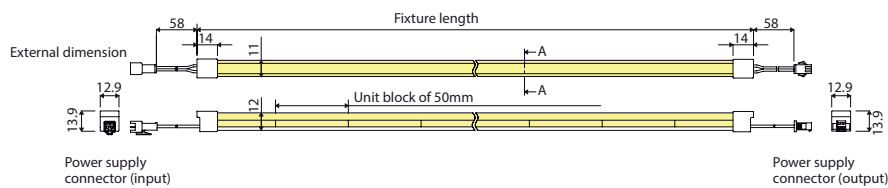

Cross sectional view A-A

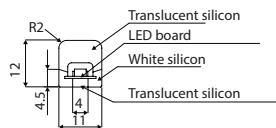

Bending direction

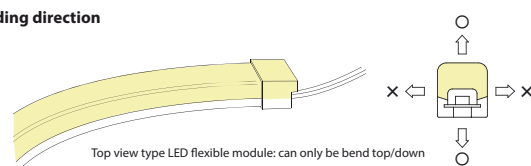

Mounting bracket installation

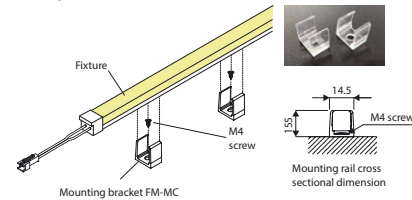

Cutting the fixture

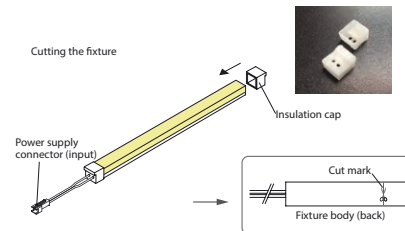

Light Intensity distribution

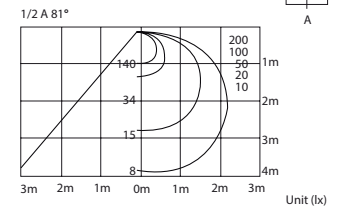

Candlepower Distribution

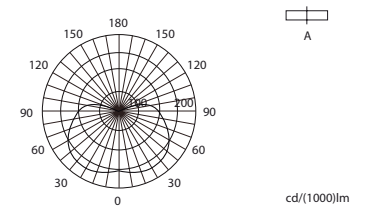



Microtec profile



Microtec FE13

- Compact flexible edge emitting, IP65 linear lighting module
- Designed to provide tailored accent lighting solutions
- Engineered LED configuration with 50mm cut-down increments
- Fixation channel or flat bar heat-sink options
- Extruded clear acrylic fixation clip option

MODEL		LENGTH	COLOUR TEMPERATURE	Lumens	WATTS
FE13 038	Minimum	58mm	2500K	25.3	0.45W
	+ Step	+ 50mm	3000K		
			3500K		
FE13 1000		1000mm	4000K	460	9.6W
			4500K		
			5000K		
FE13 6482	Maximum	6482mm	5500K	2990	62.4W

Dimensions

Unit (mm)

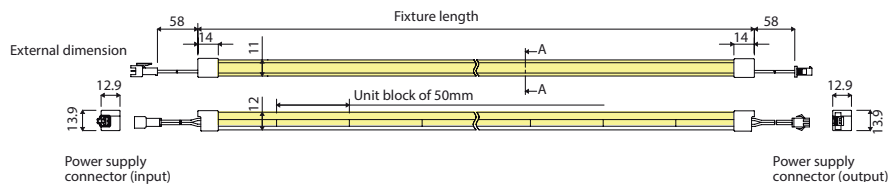

Cross sectional view A-A

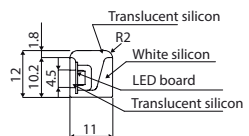

Bending direction

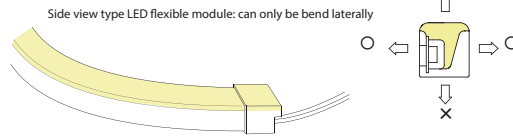

Mounting bracket installation

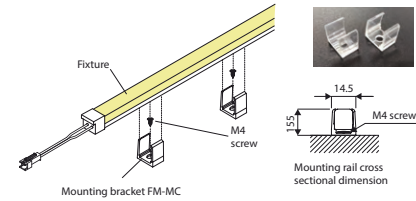

Cutting the fixture

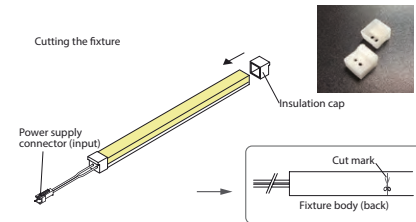

Light Intensity distribution

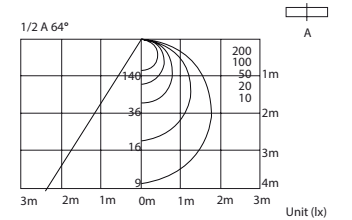

Candlepower Distribution

